



Instructions for Use



Washing machine



Thank you for your confidence in purchasing our washing machine, and congratulations on the excellent choice.

Your new washing machine meets the requirements of modern treatment of laundry. It is rational in the consumption of energy, water and washing agents.

Our appliances are friendly to the environment. Some of the materials may be recycled, others deposited or decomposed. To avoid pollution of environment, once your appliance is no longer useful, take it to your local authorized waste appliance dealer.

The appliance is intended exclusively for use in households. If the appliance is used for professional purposes, for profit, or for purposes beyond regular use in a household, or if appliance is used by a person who is not a consumer, the warranty period equals the shortest warranty period possible as stipulated by the relevant legislation.

Description of washing machine	3
Cautions	4
Installation and connection	5
Operation.....	8
Tips for washing and energy saving	16
Cleaning and maintenance	17
Troubleshooting	20
Tables	24

Description of washing machine

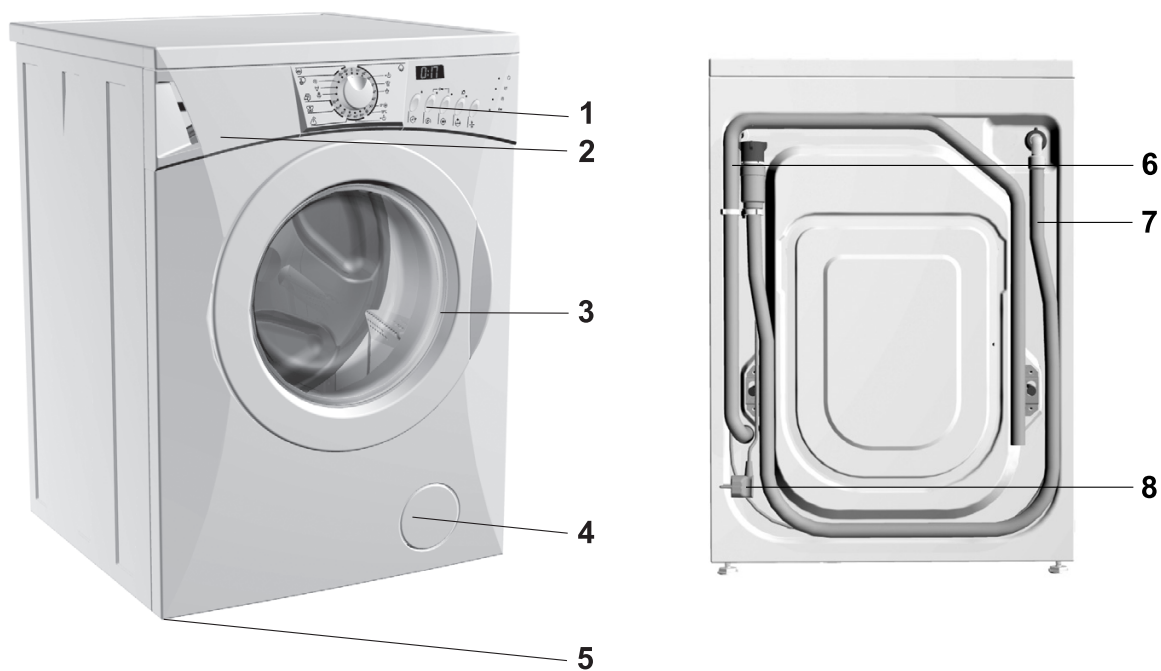

1. Front panel

2. Detergent dispenser

3. Door

4. Filter lid

5. Adjustable legs

6. Water outlet hose

7. Water inlet hose

8. Mains power cable

Technical information

(depending on model)

Dimensions (w x d x h): 600 mm x 600 mm x 850 mm

Depth with door open: 106 cm

Weight (net): 78 kg

Nominal voltage: 230 V, 50 Hz

Power: 2300 W

Max. load: 8 kg / 7 kg

Power socket: (230 V, 50 Hz, 10 A)

Water pressure: min. 0,05 MPa, maks. 0,8 MPa

Fuse: 10 A

Cautions

- Be sure to remove transport brackets prior first use of the appliance. Attempted operation of the blocked machine may result in irreparable damage which is not covered by the manufacturer's warranty!
- When connecting your washing machine to water supply, be sure to use brand new water inlet hose and appropriate sealing gaskets (attached).
- Do not locate the machine in a room with temperature below 0°C. Parts of the machine may be damaged if frozen.
- Install the washing machine in a perfectly horizontal position, on solid flat concrete floor.
- Follow the instructions for correct installation and water and mains connections.
- Never immerse the end of the drain hose into the draining water.
- Prior starting the washing cycle lock the door by pressing them at the designed spot.
- Door may not be open during the washing cycle.
- We recommend running the self-cleaning program before the first wash in order to remove any impurities from the washing machine drum (See chapter on "Selecting additional functions").
- Use only detergents and softeners for machine wash. Manufacturer may not assume responsibility for any damage and eventual discoloring of gaskets and plastic components as a consequence of incorrect use of bleach and/or coloring agents.
- For removal of lime residues use such agents with added anti-corrosion agents. Follow the manufacturer's instructions. Finish the lime removal by multiple rinsing to remove completely eventual acid residues.
- Never use detergents containing solvents, since there is a danger of creating toxic gasses which may damage the machine and result in ignition or explosion.
- Upon completion of washing operation close the water faucet.
- Before any transport block the machine by inserting at least one transport blocking rod. Prior this operation disconnect the appliance from the mains power!
- Rating plate with basic information is located above the opening of the machine.
- The warranty shall not apply to consumables (bulbs), minor discoloration or deviations of color, increased noise level as a consequence of appliance age, which does not affect appliance functionality, and aesthetical deficiencies which do not affect appliance functionality or safety.
- The appliance is manufactured in compliance with all relevant safety standards; however, it is recommended that persons with impaired physical, motional, or mental abilities, or persons with inadequate experience and knowledge, do not use the appliance without due supervision. The same recommendation applies to minors using the appliance.



Before connecting the appliance read these instructions carefully. Repairing the failure arising from inappropriate connections or use of the appliance is not covered by the guarantee.



The symbol on the product or on its packaging indicates that this product may not be treated as household waste. Instead it shall be handed over to the applicable collection point for the recycling of electrical and electronic equipment. By ensuring this product is disposed of correctly, you will help prevent potential negative consequences for the environment and human health, which could otherwise be caused by inappropriate waste handling of this product. For more detailed information about recycling of this product, please contact your local city office, your household waste disposal service or the shop where you purchased the product.

Installation and connection

Package removal

- ⚠ In removing the wrapping be careful not to damage the appliance with a sharp object.
- ⚠ Before connecting the appliance, let it warm up to room temperature (wait for two hours).

- Our appliances are packed in environmentally friendly materials which may be recycled, deposited or decomposed without any threat to the environment.
- To this end all wrappings are marked accordingly.

Removal of transport brackets



- Move the pipes.
 - Loosen screws (A) at the rear of the machine (Fig. 1).
 - Remove the brackets (B) (Fig. 1) and slide them into the groove on the blocking rod (Fig. 2) - the right one should be turned around.
 - Use the brackets to rotate blocking rods for 90° and pull them out.
 - Close the openings with attached plastic pegs.
- Save transport brackets for eventual later use.

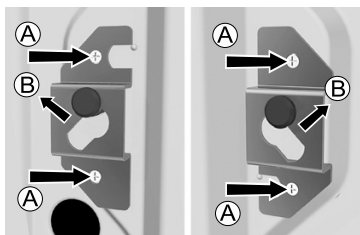

Fig. 1

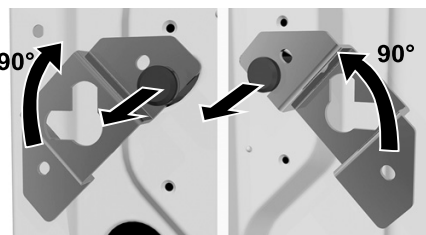
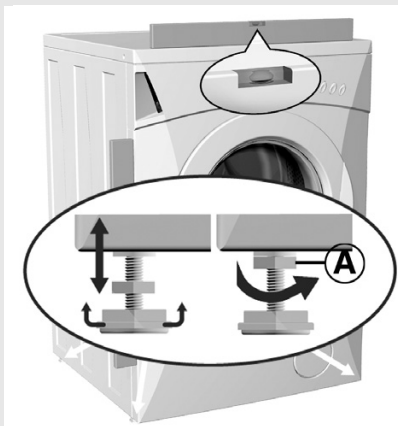

Fig. 2

- ⚠ Be sure to remove the transport brackets prior first use, otherwise the appliance may be permanently damaged. In such cases the warranty conditions are void.

Leveling the appliance



- Put the appliance in horizontal position by turning the adjustable legs. The legs are adjustable up to +/- 1 cm. **After the adjustment tighten the nuts firmly (A) - towards the bottom of the machine!**

- ⚠ Vibrations, moving of the appliance and loud operation due to incorrect setting of the adjustable feet shall not be covered by this warranty.
- ⚠ The appliance should be placed on a surface with concrete base; the surface should be dry and clean in order to prevent slipping. The adjustable feet should also be cleaned before installation.

296800



Water inlet connection

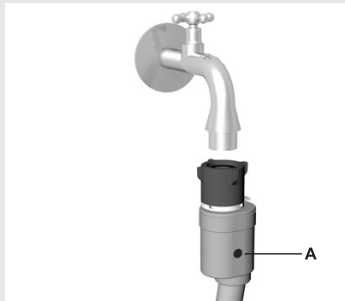
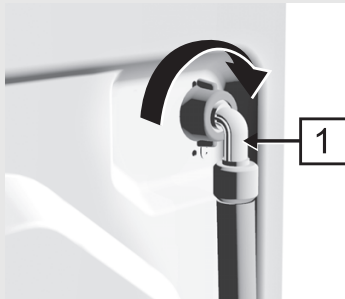

- If you have a tumble dryer of the same dimensions, you can place it on top of the washing machine.

 To ensure correct operation of the appliance, water pressure inlet must be between 0,05 and 0,8 MPa.

 Minimum water pressure can be established by measuring the quantity of poured out water. 3 litres of water must be poured out from completely opened tap in 15 seconds.

- Take the water inlet hose from the drum and attach the inlet hose angle extension (1) to the washing machine by screwing it onto the provided thread (certain models only).
- Insert the gasket with a filter net into the straight inlet hose attachment nut (2) and screw the nut onto the water tap. (With some models, the gasket with filter net is already fitted and any additional fitting into the nut on the straight attachment is not required).
- In case of hot and cold water connection, connect one hose to cold and other to hot water faucet as marked at the rear of the appliance (letters C and H) (C - cold; H - hot)

 The inlet hose should be tightened manually, firmly enough to prevent any leaks. After tightening the hose, check for any leaks. Use of pliers, wrenches, or other similar tools is not allowed when installing the hose, as these tools can damage the nut thread.

Partial Aqua-stop (water stop system)

In case of damage on the interior pipe, leaking is prevented by automatic closing system which stops water inlet to the machine. In such cases display A turns red. Inlet pipe must be replaced.

Complete Aqua-stop (certain models only)

In case of damage on the interior pipe, leaking is prevented by automatic closing system which stops water inlet to the machine. Security system also detects whether there is any water leakage within the interior of the machine. In such cases washing is suspended, machine switches on the pump and signals error.

⚠ Do not immerse the Aqua-stop system inlet pipe into the water, because it contains the electric valve!

Water outlet connection

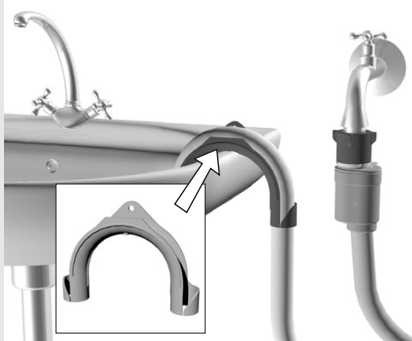

- Fix the outlet hose to run into the sink or the bathtub, or connect it directly to the wall drain outlet (diameter min. 4 cm).
- Wall drain must be installed properly and must enable occasional cleaning.
- Fasten the outlet hose support with a piece of rope led through the hose elbow, to prevent the hose from slipping to the floor. The end of outlet hose should be placed between minimum 60 cm and maximum 100 cm above the floor level.

Connect the appliance to the mains supply

- Plug the mains power cable to the wall mains socket.
- Required voltage and other information are written on the rating plate above the door opening of the machine.

⚠ The wall socket must be accessible at all times and must be equipped with an earth lead (in accordance with the local safety regulations).

⚠ The permanent connection must be fitted by an authorized personnel only.

⚠ Damaged mains power cable may be replaced only by the producer or his authorized personnel.

⚠ Never plug the appliance into the electric shaver socket or hair dryer socket.

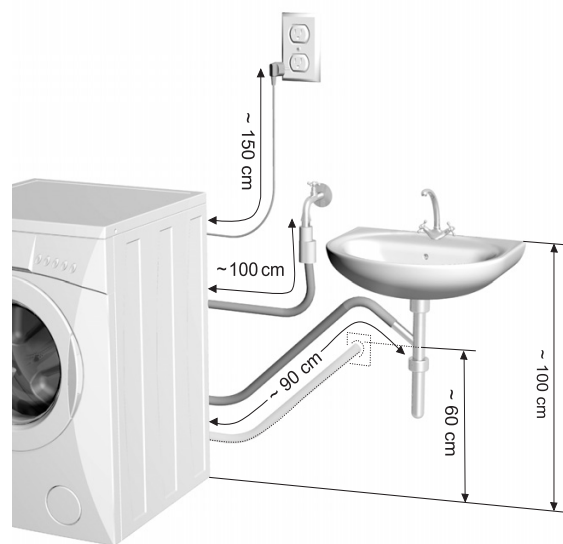
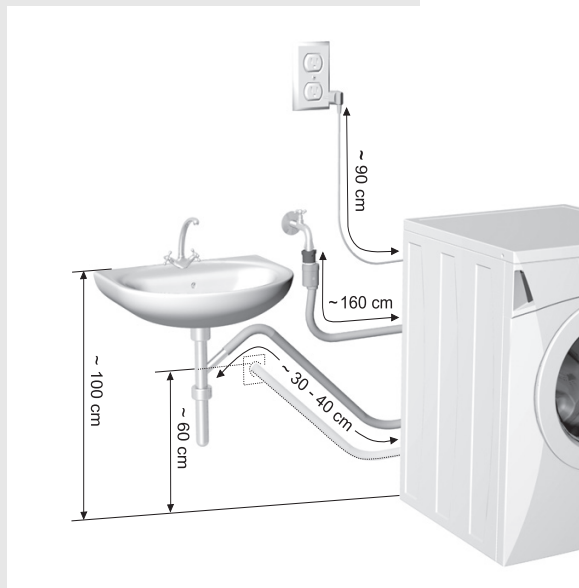

Operation

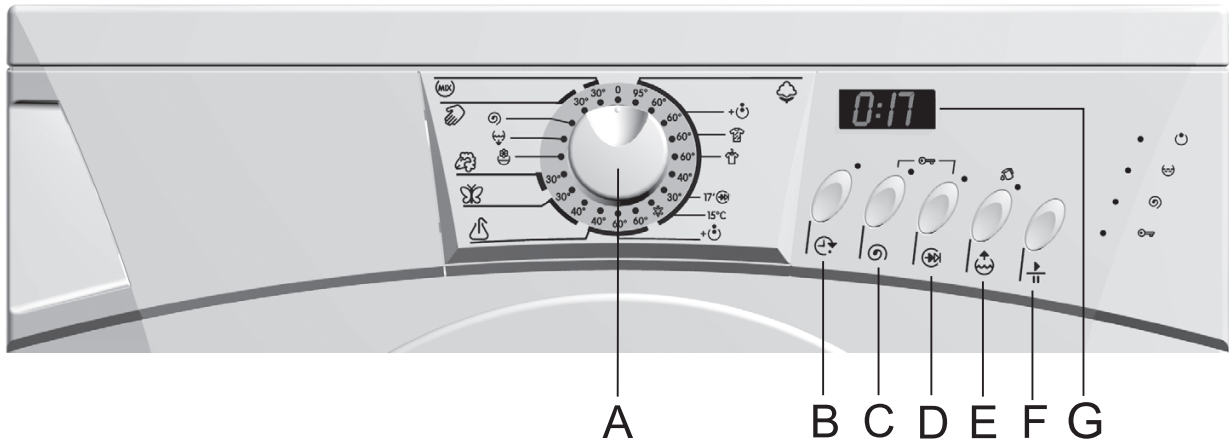

- A** - program selector knob
- B** - delayed start
- C** - setting the spinning speed (rpm) / stop pump
- D** - quick program or cold wash (depending on the model)
- E** - higher water level
- F** - START / PAUSE button
- G** - display

Signal LED's:

- washing program stages
 - wash ☺
 - rinse ☺
 - spin ☺
- Child lock 🔒

Program selector	Basic programs	Partial programs
	Cotton +☺ Pre-wash Heavy duty Easy iron 17' ⏪ Quick program 15° Tap Water+	Softening
	Synthetics +☺ Pre-wash	Pumping water
	Delicate	Spinning
	Wool	
	Manual wash	
	Mix	

Washing procedure



- Open the door of the machine.
- Load the laundry into the drum.
- Close the door.
- Open the water inlet faucet.
- Push the ON/OFF button and select the program.
- Add washing and treatment agents (detergent and softener).
- Start the operation by pushing the START knob (F).

- Open the door of the machine.

Door is opened by pulling the handle (lever) on the right hand side of the door towards you.

- Sort the laundry by the type of fabrics.

- ⚠ Do the buttons and zippers, tie the strings and pull out the pockets.
- ⚠ Very delicate laundry should be put in a special protective sack.
- ⚠ It is suggested to load the drum with items of different sizes.
- ⚠ Pay attention to the labels on the clothes, indicating the recommending washing mode (see table of textile treatment symbols on the last page of these instructions).

- Load the laundry into the drum.

Check that the drum is empty.

- Close the door of the appliance.

- Open the water inlet faucet.

- Push the ON/OFF button and select washing program.

Washing machine operation

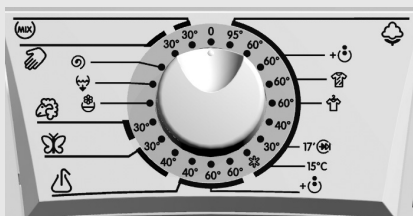

Program is selected by turning the program selector (A) from the "0" position to the desired washing program. The ON/OFF signal LED indicating particular washing stage for the chosen program starts flashing. The program selector (A) may be turned in both directions, and the appropriate program selected according to the type of laundry washed and the required washing temperature (see Program Chart for help). You may select **basic** or **partial** programs.



Select additional functions by pressing their relevant knobs (F).

- Selection of basic programs (☁, ⚙, 🧺, 🧺, 🧺, (MIX))

Basic programs represent integral programs containing all washing stages, including softening and spinning (see Program Chart). They are selected by turning the program selector (A) to the appropriate position.

Cotton: whites/colored

Normally stained cotton and flax bed linen and underwear, table cloth, bathroom towels, top garments, etc.

For heavily stained permanent press use the heavy duty program,  or program with the pre-wash .

For smaller loads (non-delicate cotton, linen, synthetic, and mixed fabric) and smaller quantities of soiled laundry (laundry refreshment, laundry wet with perspiration, etc.), we recommend the use of the 17'  quick program. This way, you will save both energy and time.

If you wish the laundry not to be excessively creased at the end of washing, use easy ironing program .

The Cotton 15° program is intended for washing less soiled laundry, using detergents (washing gels) specially designed for washing at such temperatures.

Using this program will save you both time and power as water heater will only be engaged if the water inlet temperature is lower than 15°C.

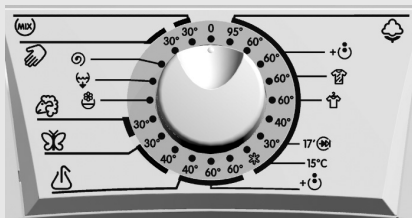

Synthetics

Normally stained shirts, blouses and other polyester and polyamide garments, or a mixture of these fabrics with cotton.

For heavily stained permanent press use program with pre-wash .

Delicate

This is a program for delicate fabrics (dresses, skirts, blouses) and curtains.

Wool

Especially gentle program for washing wool and garments made from mixture of other fabrics with wool, appropriately marked for machine washing.

Manual wash

Very gentle program concluded with short gentle spin (max. 400 RPM).

It is suitable for washing fabrics from flax, silk, wool or viscose, marked accordingly for manual wash.

Mix

Special program for washing normally stained colored laundry made from various resistant fabrics at 30°C.



- **Selection of additional function** (🕒, 🌀, H, ⚙️, ✨, 💧, 🏠)

Additional functions alter the basic washing cycle procedure. Particular function is switched on by pressing the relevant knob. The selection is confirmed with sound signal and switching on the signal LED above the selected function. If certain function is not available for the selected program, signal LED will not illuminate. The function is switched off by pressing the same button again - signal LED goes off.

⚠️ Select the particular function after the selection of the basic program, but prior pressing the START button (F).

Display (G)

After setting the basic and partial programs and pressing the START (F) button, washing time is indicated on the display. After the end of washing, the display reads END.

During washing, the remaining washing time is indicated in hours and minutes.

If no program is selected and started and no other action is taken within five minutes after turning on the machine, the display will be automatically turned off to save energy.

The display will turn on again when you rotate the program selector dial or press any button.

If no action is taken after the end of the program, the display will also turn off after five minutes.

⚠️ Low water temperature, low network voltage, and smaller loads of laundry may extend the washing time; the time indicated on the display is constantly adjusted to account for such conditions.







🕒 **Delayed start**



Press the (B) button; the time "00:00" will be indicated on the display (G). Each time the button is pressed again, the time on the display will be increased by one hour (maximum delay is 23 hours). After the time has been selected, the LED over the button lights up (and remains lit). If no other button is pressed in the following 5 seconds, program duration is indicated on the display. The function is activated when the START (F) button is pressed. Time is decreased by minutes. When the count-down is over, the washing program starts automatically.

- To interrupt or change the delayed start setting, press the START / PAUSE button.
- To change the delay time, select a new time by pressing the (B) button. Press START to resume the count-down. To quickly interrupt the delayed start, press the (B) button and hold it for three seconds. Press the START button to resume the program.

⌚ **Spinning speed (rpm) / H Pump stop**

By pressing the (C) button, you can decrease the spinning speed (in rounds per minute) to "0". After pressing the button for the first time, the optimum rpm setting for the selected program is indicated. By each subsequent press on the button, the spinning speed is decreased. The last selection is "pump stop", which means that laundry remains soaked in the last rinsing water. Use this function to prevent creasing when you are not able to take the laundry out of the washing machine immediately after the washing cycle is over. This function is particularly appropriate for synthetics  and delicate laundry . Use of this function is not recommended with wool  and manual washing .

⏪ **Quick program** (selection with a button (D))

- energy-saving program
- appropriate for washing lightly soiled laundry or smaller quantities of clothes
- reduces washing and rinsing time
- reduces water consumption (with some programs)
- by pressing the key quick program  on the program Cotton 30°C, activate the program Cotton 30°C-quick 17' .

* **Cold wash** (only available with some models)

For washing lightly soiled or color-sensitive laundry. When this function is activated, the heaters in the washing machine are turned off, and the washing program is shortened.

⤴ **Higher water level** (selection with a button (E))

- Improves rinsing, which is particularly important if your skin is oversensitive to detergents.
- For washing heavily soiled laundry.

🧼 **Auto-clean program (SterilTub)**

Run this program to eliminate any impurities, bacteria, and odor from the washing machine.

Before running the auto-clean (SterilTub) program, empty the washing machine drum; there shouldn't be any clothes in the washing machine during the auto-clean (SterilTub) program.

Adding a small amount of powder detergent will additionally improve the effect of the auto-clean (SterilTub) program.

To run the auto-clean (SterilTub) program, rotate the program selector knob (A) to the position "Cotton 95°C", then pressing the (E) (Higher water level) key and hold it for three seconds.

"Cln" and the time remaining until the end of the program will alternate on the display.

If you do not regularly use washing program with temperatures over 60°C, it is recommended to run the auto-clean program at least once per month.



Start the operation

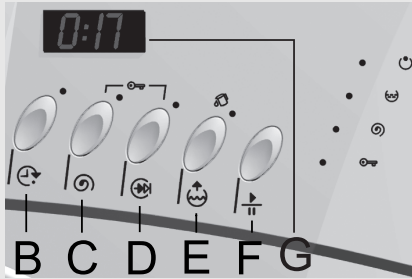

- Push the START button (F). Sound signal confirms the start, the LED indicating particular washing stages stops flashing. The machine starts operating after a few seconds. If the door is not properly closed after starting the operation, the washing stage indicator LED starts flashing again after a few seconds. When you close the door, the machine initiates the selected program.
- As each washing stage is completed the relevant washing stage indicator LED goes off and the subsequent one goes on.
- In case you would like to alter the washing program after the initiated washing operation, turn the program selector for one second to the position "0", followed by the selection of a new program. Switching the machine off deletes any previously selected additional functions(i.e. Pump stop), so they have to be reactivated.

⚠ Upon switching OFF, all additional pre-selected functions are deleted; therefore they must be switched-ON again.

- End of washing program



The end of washing program is signalized by flashing washing progress LEDs. The message "End" is indicated on the display.

- A sound is emitted, indicating that washing machine door can be opened.
- Take the laundry out of the drum and remove any remaining particles or foreign bodies from the door seal.
- Leave the door ajar to let the machine dry.
- Close the water inlet tap.
- Turn off the washing machine by rotating the program selector knob (A) to position "0".
- After the end of washing program, power supply should be turned off by pulling the mains cord plug out of the outlet.

- **By the user**

Selecting PUMP STOP function

The program stops when it reaches the PUMP STOP  position (if this additional function was previously selected); (washing machine door is closed throughout the washing process). The LED over the button (C) starts to flash. Washing can be resumed by pressing the START (F) button.

If the setting pump stop  was selected, the program stops at the last rinsing cycle and the symbol for pump stop  is indicated on the display. The program can be completed by pressing the START (F) button; in this case, the program will finish with a spinning cycle, as defined by the program.

Interruptions



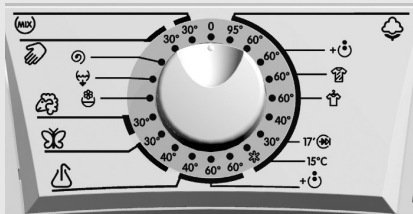

The program can also be changed by rotating the program selector knob to “0” and choosing either spinning or only pumping out the water between additional programs or cycles.

Manual cancellation

The program is cancelled if the program selector knob (A) is rotated to position “0”. If there is water in the machine, select one of the additional programs (pumping (↻), spinning (⌀)) to empty the drum and complete the program.

PAUSE knob

By pressing the PAUSE knob (F) program may be suspended at any time. After certain time you may open the door if there is no water in the drum, otherwise this is not possible. Program is continued by pressing the START knob (F).

• Failures

Program is suspended in case a failure occurs. Signal LED's are flashing and sound signal is heard (see cf. Failures).

• Power failure

At electric cutout the program is interrupted, however, after the power supply has been re-established, the program operation automatically proceeds.

⚠ If a power failure occurs when the drum is still full of water, be careful not to open the door before you pump the water out.

Special functions

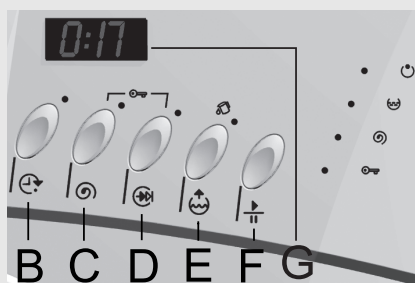

• Child lock

- To activate the child lock, simultaneously press the spinning speed setting (⌀) button (C) and short program (↻) (or cold wash ❄) button (D) and hold them for at least three seconds. If the child lock is successfully activated, a sound is emitted and a signal LED lights up. Follow the same procedure to deactivate the lock.
- As long as the Child lock function is engaged you may not alter the program or additional functions. You may merely switch off the machine by turning the program selector (A) to the position “0”. Child lock remains active even after the appliance is switched off, and you have to disengage it if you want to select a new washing program.

• Setting the sound signal

The appliance enables setting a louder sound signal, as well as turning the sound signal off. Set the function before the basic program is selected. Set the function by simultaneously

pressing the button (D) and rotating the program selector knob (A) from position "0" to the first position for washing program (clockwise). ("S1") is indicated on the display, denoting preset normal sound signal loudness. By pressing the button (D), the loudness is increased ("S2"); press the button again to turn the sound signal off ("S0"). The selected setting is stored and remains in memory even if washing machine is turned off.

Tips for washing and energy saving

- Before washing sort out the laundry according to the type, degree of dirtiness and color resistance.
- Prior selecting the washing program consult the sewn tab with information on a particular piece of laundry (see **Maintenance Chart** on the last page).
- Wash separately the new colored textile products for the first time.
- Wash heavily soiled laundry in small quantities and add more detergent.
- Treat stubborn stains with special stain remover, it will save energy.
- With lightly stained laundry select washing program without pre-wash, use short program and select lower washing temperature. This way you may save up to 50% of energy.
- Avoid washing too little quantities of laundry because of energy saving and for better performances of the appliance.
- The largest allowed quantity of dry laundry is indicated in the **Program chart**.
- Before washing empty the pockets, close zip fasteners, and remove any metal fasteners or badges that might clog the drain or damage the laundry or drum interior.
- Loosen the stacked laundry prior inserting it into the drum.
- Use only detergents for machine wash.
- Add powder or liquid detergents according to the manufacturer's instructions.
- If water hardness level exceeds 14°dH degrees, the use of water conditioner is required. Any damage to the heater due to failure to use a water conditioning agent shall not be covered by this warranty.
- Chlorine-based whitening agents are not recommended, as it can damage the heater.

Hardness scale	Degree of hardness			
	°dH(°N)	m mol/l	°fH(°F)	p.p.m.
1 - Soft	< 8,4	< 1,5	< 15	< 150
2 - Medium	8,4 - 14	1,5 - 2,5	15 - 25	150 - 250
3 - Hard	> 14	> 2,5	> 25	> 250

In case of hard water add detergent according to the Chart for degree 1 and add appropriate quantity of water softener (see manufacturer's instructions).

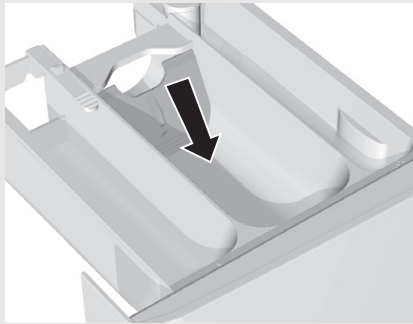
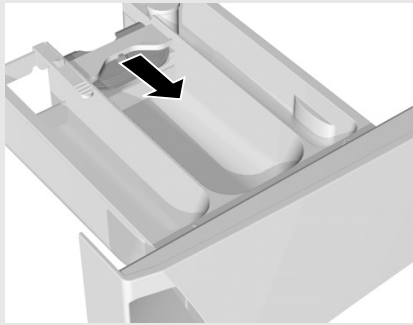

- If you do not apply the program which includes the pre-wash feature, you may add washing detergent directly into the drum.
- If you use thick liquid softener it is recommended to dilute it with water, to prevent clogging of dispenser compartment ducts.
- Washing machine is equipped with the dispenser partition gate, so you may pour liquid detergent also into the central compartment (depending on model). If you use powder detergent the gate is lifted up, and in case of liquid detergent it is slid down.
- Liquid detergents are intended for main wash only, without pre-wash.
- Insert particularly delicate linen (stockings, delicate female underwear, etc.) into the special bag.
- High spin RPM leave less moisture in laundry which dries out much quicker in the tumble dryer, thereby saving energy.



Do not put clods of detergent into the soap dispenser as the tube in the washing machine may clog.

Cleaning and maintenance



Disconnect the washing machine from the mains before cleaning!

- The casing should be cleaned with soft cloth and mild detergent.
- The interior of the drum and the door gasket is cleaned by washing at 60°C without laundry and adding half quantity of detergent.
- Frequent, or predominant, washing at low temperatures, using liquid detergents, may result in development of bacteria which causes odor in the washing machine.
To prevent this, we recommend running the auto-clean (SterilTub) program occasionally (see chapter “OPERATION / selecting additional functions”).
- If necessary, clean the detergent dispenser. Pull it out from its casing completely by pressing the flap (see Fig.).

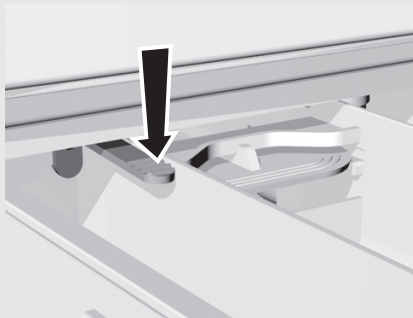



- If necessary, clean the cover of the bung under the running water.

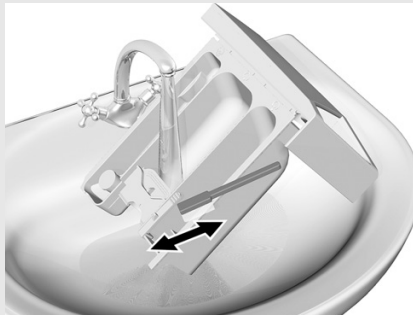

- Wash it under running water using a brush, and dry it. Remove any leftover dried detergent from the bottom of the casing.

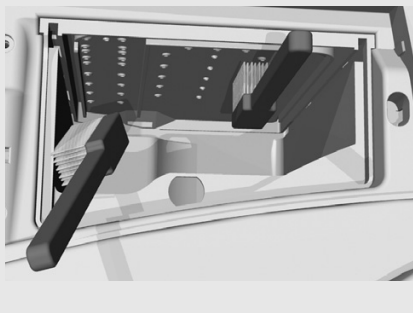

- Clean the entire rinsing area of the washing machine with a brush, especially the nozzles on the upper side of the rinsing chamber.

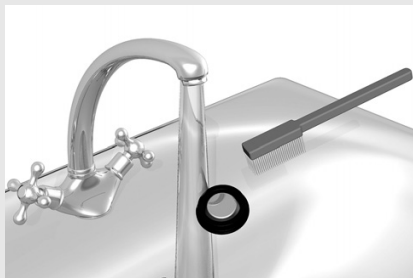

- Clean frequently the water inlet hose screen under running water.
- After each wash wipe the door rubber gasket. This will prolong its useful life.

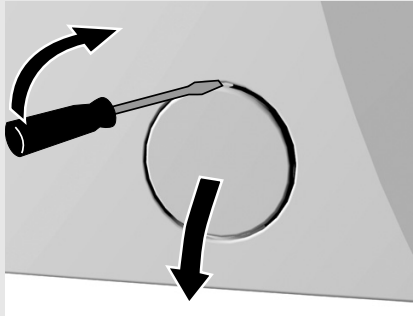

- Open the filter lid using flat screwdriver or similar tool.

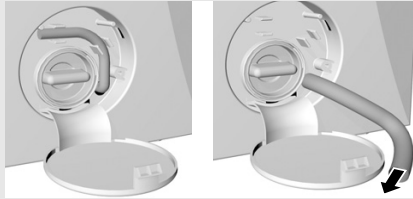

- Filter needs occasional cleaning, especially following heavily shaggy or old laundry. Before cleaning, drain any water from the machine via drain pipe.

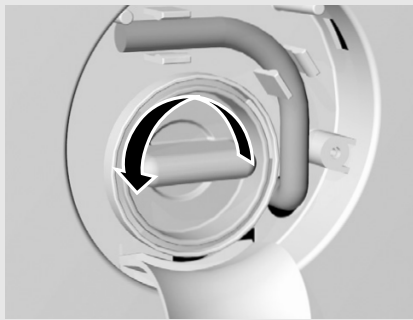

- Turn it anti-clockwise, pull it out and clean under running water.

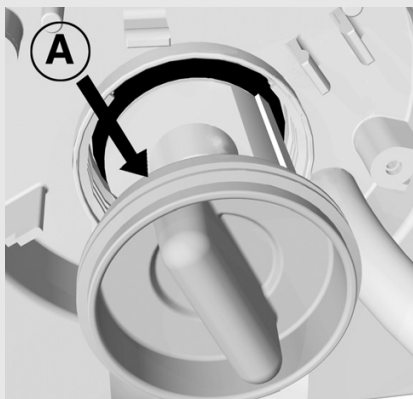

- Insert the filter back as shown on the picture, and tighten by turning it in clockwise direction. To ensure good sealing the gasket surface (A) must be dirt free.

Troubleshooting

Washing machine controls the operation of particular functions during washing. If irregularities are detected, the fault is signaled by displaying a message (Fx) on the display, and by rhythmical flashing of the LEDs. Simultaneously with the flashing of the LEDs, a sound signal is emitted several times, in the same rhythm. The machine signals the fault as soon as it is detected, and the program progress is paused. If the fault is in the heating system, the machine completes the washing program, but without the heating function.

If the fault is signaled during washing machine operation, the error code and remaining washing time are indicated alternately on the display.

The fault is indicated until the washing machine is turned off.

Failures:

- 2 - Two flashes: door is not correctly closed
- 3 - Three flashes: inappropriate water intake
- 7 - Seven flashes: inappropriate water outlet.

In these cases, you will be able to remedy the failure by yourself (See Troubleshooting table).

- 1 - One flash: temperature sensor failure
- 4 - Four flashes: spinning sensor failure
- 5 - Five flashes: motor failure
- 6 - Six flashes: Heater failure

Should any of these failures occur, make note of the failure code, turn off the appliance and repeat the program. If the failure persists, contact the nearest authorized service centre (the LEDs will continue to flash until the appliance is turned off).

Various interferences from the environment (e.g. electric devices) may also cause the machine to signal faults. In such case:

- turn off the appliance and wait a few seconds;
- turn on the appliance and repeat the washing program.

If the fault reoccurs, call the service center.

The warranty does not cover faults caused by interference from the environment (lightning strike, electric circuit, natural disasters, etc.).

Failure	Possible cause	Remedy
The machine does not work (indicator LED's are not illuminated).	Machine is not powered.	Check if: <ul style="list-style-type: none"> • power in the socket, • the fuse is OK, • plug is in the socket.
FAILURE 2 Washing program does not start <ul style="list-style-type: none"> • At the beginning of the washing program: on/off LED is flashing • During washing: LEDs periodically flash twice 	Door is not properly closed.	Push it towards the machine.
FAILURE 3 Water does not enter the machine (after approx. 4 min the machine reports failure F3 - LEDs periodically flash three times).	Disturbed water inlet.	Check if: <ul style="list-style-type: none"> • the water tap is open, • inlet pipe net filter is clean. Push the START button.
Water is leaking from the machine.	Filter is not tightly screwed in. Inlet pipe is not tightly screwed to the machine or to the water faucet. Outlet pipe fell to the floor.	Tighten the filter properly. Tighten the inlet pipe. Affix the outlet pipe to the drain.
The machine moves during operation.	The machine is not properly leveled. Transport brackets are not removed.	Level the machine with the adjustable legs. Remove transport brackets.
The machine vibrates during the spin.	Unevenly distributed laundry, especially with very small quantities (for ex. only the bathrobe).	This is normal, the machine will reduce the RPM if vibrations are too strong. Wash larger quantity of laundry.
Excessive foaming during washing.	Excessive measure of detergent.	Use washing powder according to the instructions by the producer and according to the water hardness and soiled laundry. Use only detergents for machine washing.
FAILURE 7 Water is poorly pumped out or not at all (machine reports failure F7 - the LEDs periodically flash seven times).	Water outlet is clogged	Check if: <ul style="list-style-type: none"> • the filter is clean, • outlet pipe is not jammed, • the drain is clogged, • outlet pipe is positioned higher than 1m. Push START again
Laundry is not properly spun. No failure is reported.	The machine switched on the UKS* function. Because of bad laundry balance, the machine has automatically reduced spin RPM.	The machine operates normally. Wash large and small pieces of laundry together.

Failure	Possible cause	Remedy
Greasy wads appear on the laundry.	Too little detergent (laundry was very greasy).	Wash the laundry again. Add more detergent for such soiled laundry, or use liquid detergent.
Laundry is stained after washing.	You used liquid detergent or detergent for colored laundry which does not contain whitener.	Use the detergent containing whitener.
White powdery residues on the laundry.	It is not the consequence of bad rinsing, but because of neo-phosphate detergents containing non soluble components (zeolites) for water softening. Such substances may be deposited upon the laundry.	Immediately rinse the laundry once again. <ul style="list-style-type: none"> • Use liquid detergents which do not contain zeolites. • Try removing the residues with the brush.
Detergent residues in the dispenser.	Low water flow pressure. Some detergents may stick to the dispenser rather hard if it is wet.	<ul style="list-style-type: none"> • Clean the inlet pipe filter net. • In case of low water pressure increase water level. • Wipe the dispenser prior loading detergent.
Softener is not completely rinsed, or water is left in the dispenser dish.	Sucking cover is not correctly positioned or is clogged.	Clean the dispenser and firmly fix the cover to its place.
Unpleasant smell in the washing machine drum.	<ul style="list-style-type: none"> • Remains of fabrics, washing agent and softener in the filter. • Development of germs 	<ul style="list-style-type: none"> • Check whether the filter is clean. • Run the auto-clean (SterilTub) program (see chapter: selecting additional functions)
Washing time is longer than usual. Time indicated on the display is corrected during the washing cycle.	<ul style="list-style-type: none"> • Low temperature of inlet water. • The machine switched on the UKS* system because of uneven laundry load. • Low mains voltage. • There has been a failure in the power supply. 	<ul style="list-style-type: none"> • Washing program time may be up to 60% longer; however, this does not imply a fault in the machine. • Washing time is extended by the power supply down-time.
FAILURE 1 Program temperature not reached (the machine reports a failure F1 - the LEDs periodically flash once)	Temperature sensor disconnected from the electronic circuit.	<ul style="list-style-type: none"> • Turn off the appliance and wait for a few seconds; • turn the appliance back on and repeat the washing program. If the failure is reported again, call a service technician.
FAILURE 4 Spinning rpm not reached in the selected program (the machine reports a failure F4 - the LEDs periodically flash four times)	<ul style="list-style-type: none"> • rpm sensor disconnected • Motor overload due to too high water level (manual addition of water) or too big laundry load • Motor failure 	<ul style="list-style-type: none"> • Turn off the appliance and wait for a few seconds; • turn the appliance back on and repeat the washing program. If the failure is reported again, call a service technician.

Failure	Possible cause	Remedy
FAILURE 5 Motor operation interrupted; or motor does not operate (the machine reports a failure F5 - the LEDs periodically flash five times)	Motor overload or motor failure.	<ul style="list-style-type: none"> • Turn off the appliance and wait for a few seconds; • turn the appliance back on and repeat the washing program. If the failure is reported again, call a service technician.
FAILURE 6 Program temperature not reached (the machine reports a failure F6 - the LEDs periodically flash six times)	<ul style="list-style-type: none"> • Heater failure • Inlet water too cold • Manual addition of water 	<ul style="list-style-type: none"> • Turn off the appliance and wait for a few seconds; • turn the appliance back on and repeat the washing program. If the failure is reported again, call a service technician.

* UKS: universal stability control - this function prevents excessive vibrations during spinning.

In case you were not successful in repairing the malfunctions in spite of the above suggestion chart, call the nearest authorized service shop.

Repairing the failure arising from inappropriate connections or use of the appliance is not covered by the guarantee, and the repair expenses are paid by the customer.

Tables

Program chart - 8 kg

Basic programs	Max. load (kg)	Temp. (°C)	Spin (RPM)	Water cons. (L)	Energy cons. (kWh)
				RPM	
				1000 - 1400	
Cotton	8	95	1400	75	2,45
Cotton	8	60		69	1,36
Cotton + prewash	8	60		79	1,65
Cotton - heavy *	8	60		69	1,38
Cotton - easy ironing	4	60	1000	69	1,27
Cotton	8	40	1400	69	0,75
Cotton	8	30		69	0,39
Cotton - quick 17'	2	30	1000	40	0,17
Cotton - Tap Water+	8	15	1400	69	0,18
Synthetics	3,5	60	1000	46	0,97
Synthetics + prewash	3,5	60		54	1,30
Synthetics	3,5	40		43	0,56
Delicate	3	40	700	58	0,48
Delicate	3	30		58	0,39
Wool	2	30	800	42	0,20
Manual wash	1,5	30	800	50	0,25
Mix	3	30	1000	43	0,35
Partial programs					
Softening	3,5		1000	15	0,02
Pumping water	8		-		
Spinning	8		1400	-	0,03





* Testing program by EN 60456 with the selection of max. spin RPM.

Program chart - 7 kg

Basic programs	Max. load (kg)	Temp. (°C)	Spin (RPM)	Water cons. (L)	Energy cons. (kWh)
				RPM	
				800 - 1600	
Cotton	7	95	1600	62	2,19
Cotton	7	60		56	1,17
Cotton + prewash	7	60		66	1,32
Cotton - heavy *	7	60		56	1,19
Cotton - easy ironing	3,5	60	1000	56	1,14
Cotton	7	40	1600	56	0,67
Cotton	7	30		56	0,35
Cotton - quick 17'	2	30	1000	40	0,17
Cotton - Tap Water+	7	15	1600	56	0,18
Synthetics	3,5	60	1000	46	0,97
Synthetics + prewash	3,5	60		54	1,30
Synthetics	3,5	40		43	0,56
Delicate	3	40	700	58	0,48
Delicate	3	30		58	0,39
Wool	2	30	800	42	0,20
Manual wash	1,5	30	800	50	0,25
Mix	3,5	30	1000	43	0,35
Partial programs					
Softening	3,5		1000	18	0,02
Pumping water	7		-		0,001
Spinning	7		1600		0,03

* Testing program by EN 60456 with the selection of max. spin RPM.

































**Program chart /
Additional functions**

Program	 Higher water level	 / Cold wash* 	 / Pump stop 
Basic programs			
Cotton	●	●/●	●/●
Cotton with prewash	●		●/●
Cotton heavy	●		●/●
Cotton	●	●/●	●/●
Cotton - quick 17'	●		●/●
Synthetics with pre-wash	●		●/●
Synthetics	●	●/●	●/●
Delicate	●	●/●	●/●
Wool	●	●/●	●/●
Manual wash	●	●/●	●/●
Mix	●	●/●	●/●
Partial programs			
Rinse			●
Softening			●
Pumping water			
Spinning			●

● possibility

* depending on model.

Maintenance chart

<p>Normal wash</p>  <p>Delicate wash</p> 	 <p>Max. washing temp. 95°C</p> 	 <p>Max. washing temp. 60°C</p> 	 <p>Max. washing temp. 40°C</p> 	 <p>Max. washing temp. 30°C</p> 	 <p>Manual washing</p>	 <p>Washing not allowed</p>
 <p>Whitening</p>	 <p>Whitening in cold water</p>			 <p>Whitening not allowed</p>		
 <p>Ironing</p>	 <p>Hot iron max. 200°C</p>	 <p>Hot iron max. 150°C</p>	 <p>Hot iron max. 110°C</p>	 <p>Ironing not allowed</p>		
 <p>Dry cleaning</p>	 <p>Dry cleaning in all solvents</p>	 <p>Perchlorin-ethylene R11, R113, Kerosene</p>	 <p>Dry cleaning in kerosene, in pure alcohol and in R 113</p>	 <p>Dry cleaning not allowed</p>		
 <p>Drying</p>	 <p>Place on flat surface</p>	 <p>Hang wet</p>	 <p>Hang</p>	 High temperature  Low temperature	 <p>Tumble drying not allowed</p>	

We reserve the rights to make any changes or mistakes in these operation instructions.

296800

PS PG2 LED 8/7kg



296800

296800/en (12-10)