

Miele

SOFTTRONIC 

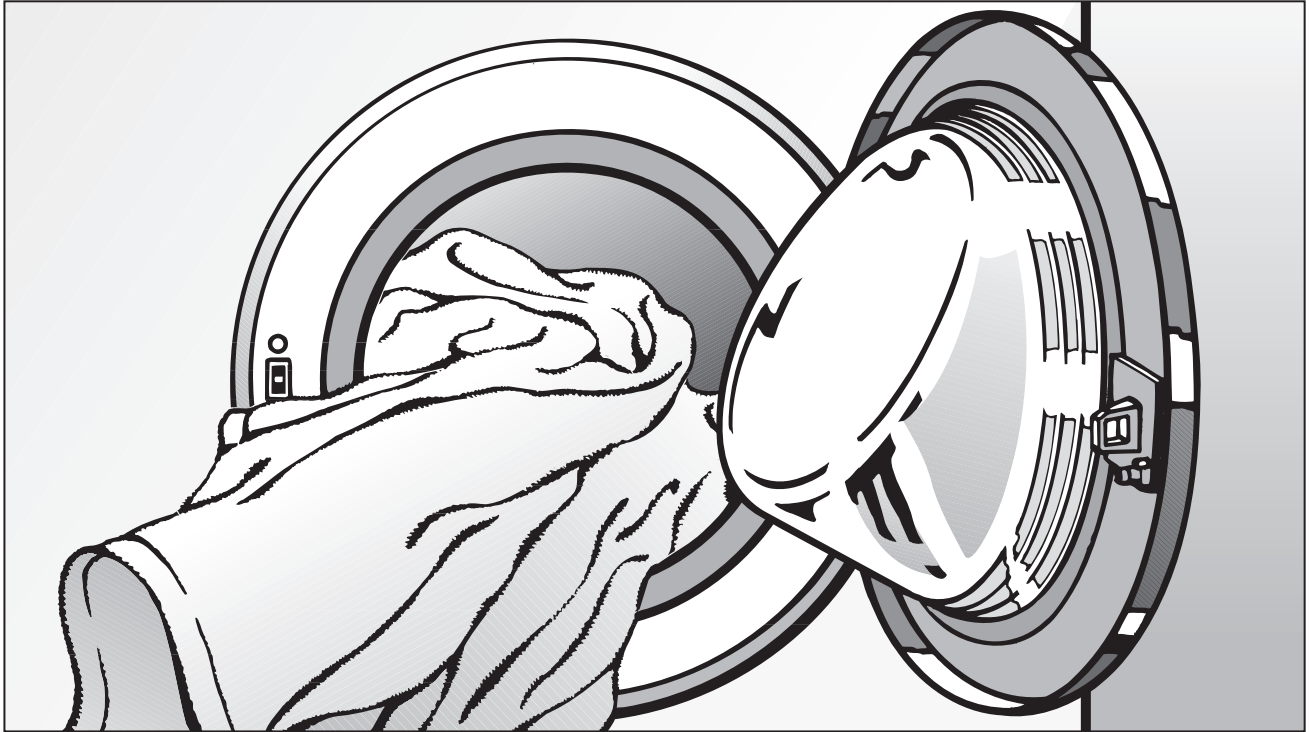

Operating instructions Washer W 1113

To prevent accidents and
machine damage,
read these instructions
before installation or use.



M.-Nr. 05 874 940





Contents

IMPORTANT SAFETY INSTRUCTIONS	4
Guide to the washer	5
Control panel	5
Before using for the first time	6
Using the washer	7
1. Prepare and sort the laundry	7
2. Load the laundry	8
3. Select a program	8
Program guide	9
4. Select wash options (if needed)	11
5. Select the temperature and spin speed	12
6. Add detergent	14
Detergent	15
Water softener	16
Fabric softener	17
Starch	18
Fabric dye	18
Using the washer	19
7. Select Delay Start (if needed)	19
8. Start the program	19
9. Activate the program lock (if necessary)	19
10. Remove the laundry	20
Cancelling a program	21
Interrupting a program	21
Making changes to the program	21
Adding/removing laundry during a wash program	22
Locking the washer	23
Electronic program lock	23
Child Safety Lock	23
Washer care	24
Cleaning the washer	24
Cleaning the detergent drawer	24
Cleaning the drain pump	25
Quick Guide	Center pages







Washer care	27
Cleaning the water inlet filters	27
Cleaning the inlet hose filter	27
Cleaning the filter in the inlet valve	27
Frequently asked questions	28
A wash program cannot be started	28
The program was interrupted and a fault message appears.	29
General issues with the washer	30
Poor wash results.	31
The door will not open when the "Door" button is pressed.	32
Opening the drum door during a power failure	33
Technical Service	34
Repairs	34
PC Update	34
Warranty terms	34
Optional accessories	34
Help protect our environment	36
Installation	37
Front view.	37
Back view.	38
Installation site	39
Installation	40
Remove the shipping struts	40
Installing the shipping struts	42
Level the washer	43
Installation beneath a counter	44
Washer stand with drawer	44
Washer/ Dryer Stack	44
Plumbing	45
Water connection	46
Drainage	47
Electrical connection	48

IMPORTANT SAFETY INSTRUCTIONS

 **WARNING** - To reduce the risk of fire, electric shock or injury to persons while using your appliance, follow basic safety precautions, including the following:

-  Read all instructions before using the appliance.
-  **GROUNDING INSTRUCTIONS**
This appliance must be grounded. In the event of malfunction or breakdown, grounding will reduce the risk of electric shock by providing a path of least resistance for electric current. This appliance is equipped with a cord having an equipment-grounding conductor and a grounding plug. The plug must be plugged into an appropriate outlet that is properly installed and grounded in accordance with all local codes and ordinances.
-  **WARNING** - Improper connection of the equipment-grounding conductor can result in a risk of electric shock. Check with a qualified electrician or serviceman if you are in doubt as to whether the appliance is properly grounded.
-  Do not modify the plug provided with the appliance - if it will not fit the outlet, have a proper outlet installed by a qualified electrician.
-  Do not wash articles that have been previously cleaned in, washed in, soaked in or spotted with gasoline, dry-cleaning solvents or other flammable or explosive substances.

These articles give off vapors that could ignite or explode. Do not add these items to the washload.

-  Under certain conditions, hydrogen gas may be produced in a hot water system that has not been used for 2 weeks or more. **HYDROGEN GAS IS EXPLOSIVE.** If the hot water system has not been used for such a period, turn on all hot water faucets and let the water flow from each for several minutes before using the washing machine. This will release any built up hydrogen gas. Do not smoke or use an open flame during this time, as the gas is flammable .
-  Do not allow children to play on or in the appliance. Close supervision is necessary when the appliance is used near children.
-  Before the appliance is removed from service or discarded, remove the door.
-  Do not reach into the appliance if the drum is moving.
-  Do not install or store this appliance where it will be exposed to the weather.
-  Do not tamper with the controls.
-  Do not repair or replace any part of the appliance or attempt any servicing unless specifically recommended in these operating instructions.

SAVE THESE INSTRUCTIONS

Control panel

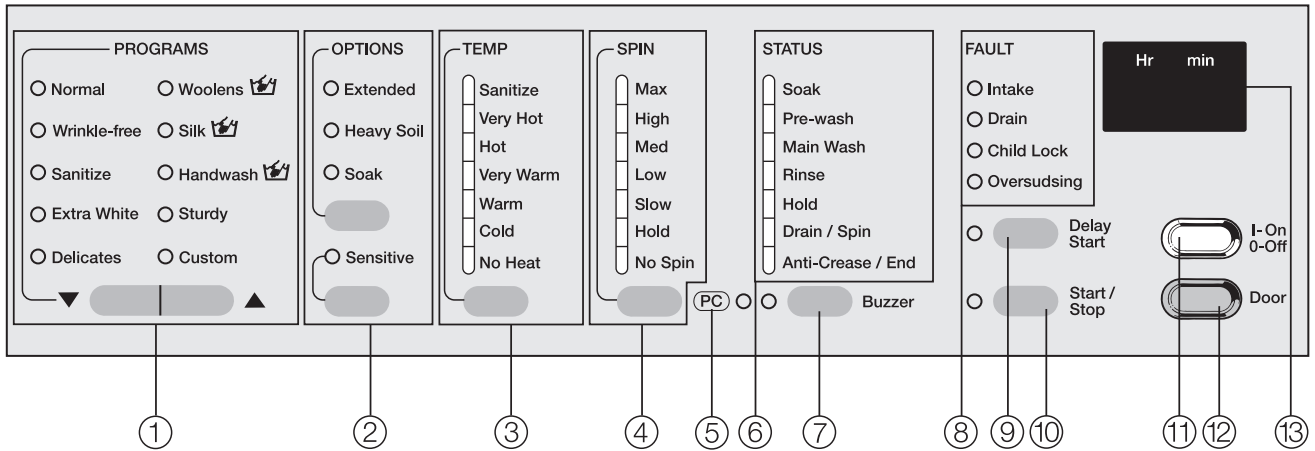

① Program selection buttons ▼▲

For selecting a program.

② Wash options

Special features to enhance a wash program.

③ Temperature button

For selecting the desired wash temperature.

④ Spin speed button

For selecting the desired spin speed.

⑤ PC Indicator

Allows a service technician to check and update the wash programs.

⑥ Program sequence display

Shows the current cycle of the wash program.

⑦ "Buzzer" button

⑧ FAULT-indicators

⑨ "Delay Start" button

For delaying the start of a program.

⑩ "Start/Stop" button

Begins the wash program or interrupts a program.

⑪ "On/Off" button

Turns the machine on and off.

⑫ "Door" button

Opens the drum door.

⑬ Display (h min)

Shows the delayed start time and the countdown to the end of the program.

Before using for the first time

The appliance must be correctly installed and connected before the first use. Please see the "Installation instructions".

For safety reasons, it is not possible to run a spin cycle before the first use. A program must be run **without laundry and without detergent** to flush out any residual water from the factory testing process, as well as to activate the spin cycle. Using detergent can cause sudsing and ball valve activation, resulting in the future maximum use of detergent.

- Turn on the water valve.
- Press the "On/Off" button.
- Select the "Extra White" program with the program buttons.
- Press the "Start/Stop" button **G**.

Once the program ends, the washer can be used for laundry.

1. Prepare and sort the laundry

- Empty all pockets.

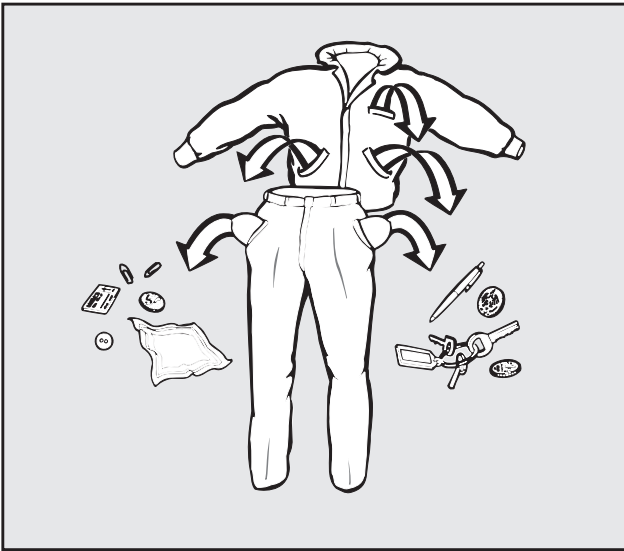

⚠ Foreign objects left in pockets (e.g. nails, coins, paper clips, etc.) can cause damage to clothes and the machine.

- Sort the laundry.

Only wash items in the machine that are labeled machine washable by the manufacturer. Most garments have a fabric care label in the collar or side seam. Sort the laundry by care label and color.

- Pretreat stains.

Tough stains (e.g. blood, egg, coffee, tea, etc.) or badly soiled areas (e.g. collars and cuffs) should be penetrated with a stain remover or a paste made from powdered detergent and warm water.

⚠ Do not use chemical solvents in the machine.

General tips

- Dark fabrics often bleed the first few times they are washed. They should be washed separately several times before being included in a mixed load.
- Remove any lead weights or strips from curtains before washing.
- Loose undergarment underwires should be removed or sewn in place before washing.
- Woolens and knitted garments should be turned inside out.
- Close zippers, hooks and eyelets before washing.
- Comforter covers and pillowcases should be fastened in order to prevent small items from rolling inside of them.

Do **not** machine wash items if it is not recommended on the fabric care label.

Using the washer

2. Load the laundry

- Turn on the washer using the "On/Off" button.
- Open the drum door using the "Door" button.
- Load the laundry into the drum. For best results, wash mixed loads of small and large items. This will improve washing effectiveness and help distribute the load evenly.

Note: Overloading the washer will cause poor wash results and wrinkling.

- Close the drum door.

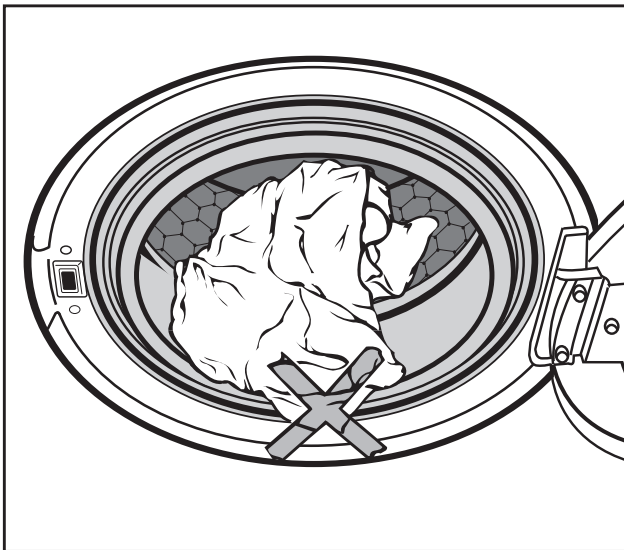



























To prevent damage to the door seal and clothing, make sure that there are no clothes caught between the drum door and the seal.

3. Select a program

































- Press the "PROGRAMS" button ▼ or ▲ until the desired program indicator lights.

Program guide

Temperatures	Fabric care symbol	Spin speed	Laundry
Normal	Options: Extended, Heavy Soil, Soak, Sensitive		
Hot			For a rapid wash of colorfast items and mixed loads made from cottons and linen, e.g. jeans, t-shirts, underwear, socks.
Very Warm			
Warm			
Cold			
No Heat			
Wrinkle-free	Options: Extended, Heavy Soil, Soak, Sensitive		
Hot			For cotton blends, polyester blends and synthetics (e.g. acrylic, nylon, ramie). Fabric softener can be dispensed in the final rinse of these programs to reduce static cling.
Very Warm			
Warm			
Cold			
No Heat			
Sanitize	Options: Extended, Heavy Soil, Soak, Sensitive		
Sanitize			For white items with special hygienic demands, e.g. baby clothing, underwear, towels.
Very Hot		High	
Extra White	Options: Extended, Heavy Soil, Soak		
Sanitize			For white items without special hygienic demands.
Very Hot		High	
Hot			
Delicates	Options: Extended, Heavy Soil, Soak		
Warm			For delicate machine washable clothing, e.g. satin, hosiery, lingerie, lace or crocheted (non-wool) items.
Cold			
No Heat			

Using the washer

Temperatures	Fabric care symbol		Spin speed	Laundry
Woolens 	Options: Sensitive			
Warm			High	For hand washable and machine washable wool and wool blends.
Cold			Med	
No Heat				
Silk	Options: Sensitive			
Cold			Slow	For hand washable and machine washable silks and other non-wool handwashable garments.
No Heat				
Handwash 	Options: Extended, Heavy soil, Sensitive			
Warm			Med	For handwashable items with no wool or silk content.
Cold				
No Heat				
Sturdy	Options: None			
Warm			Med	For a mixed load of colorfast or perma press items, or for cotton blends.
Cold			Low	
No Heat				
Custom	Options: Extended, Heavy Soil, Soak, Sensitive			
Sanitize			Max	All options can be selected individually for colorfast or white items.
Very Hot			High	
Hot			Med	
Very Warm			Low	
Warm			Slow	
Cold			Hold	
No Heat			No Spin	

4. Select wash options (if needed)

The upper button selects the following "OPTIONS":

- Extended
- Extended and Heavy Soil
- Extended and Soak
- Heavy Soil
- Soak
- no selection

The lower button selects the "Sensitive" options.

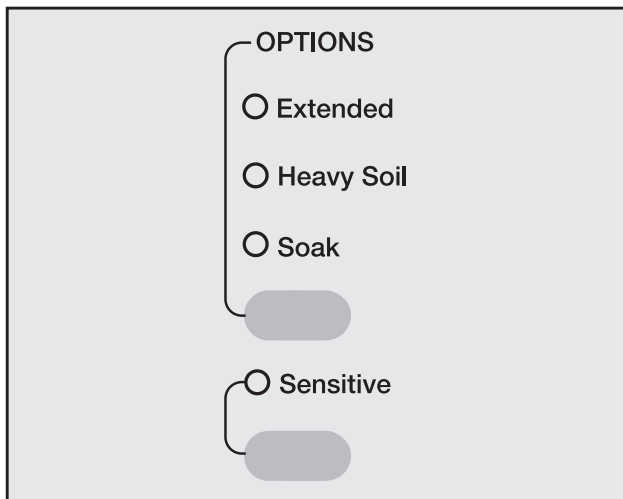

- Select the desired "OPTIONS". Press the upper button until the indicator of the desired wash option lights.

See the Program Guide to determine which options can be selected in each program.

If a wash option is chosen and it is not compatible with the program, the indicator light will go out when the button is released.

Extended

For laundry with normal to heavy soiling or stains.

The main wash cycle time for the wash program will be extended.

Heavy Soil

For heavily soiled laundry where a pretreatment is necessary to remove surface soiling.

Soak

For heavy soiling and stubborn stains (e.g. blood, grease, chocolate) that require soaking before the main wash.

The preset soak time is 2 hours.

Sensitive

An additional final rinse that will wash away detergent residue and scents.

Buzzer

A buzzer signals the end of the wash program, or after "No spin".

The buzzer will sound until the washer is turned off. Once activated, the buzzer is active in all programs unless turned off.

The warning sound (indicating a fault has occurred) will activate independent of whether the buzzer is turned on or off.



Using the washer

5. Select the temperature and spin speed

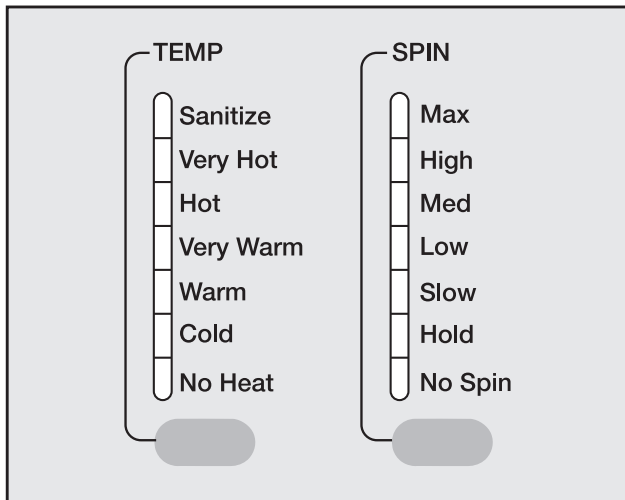
The default temperature and spin speed will automatically be selected for each program. However, you can adjust the temperature and spin speed within the parameters of the selected wash program.



- Press the "TEMP" and "SPIN" buttons until the indicator of the desired setting lights.

Program	Spin speed
Normal	High
Wrinkle Free	Med
Sanitize	High
Extra White	High
Delicates	Low
Woolens 	High
Silk 	Slow
Handwash 	Med
Sturdy	Med
Custom	Med-no Spin

The laundry is spun after the main wash and between the rinse cycles. Reducing the final spin speed will also reduce the rinse spin speeds. If in the programs "Sturdy" and "Custom" a spin speed lower than "Med" is selected, an extra rinse cycle is added to remove any detergent left in the laundry.

Special spin options

Hold

- Select "Hold".

The laundry is not spun and remains soaking in water. This will prevent wrinkles if the laundry is not removed immediately at the end of the wash program.

- To start the final spin:

The washer is set to default to the maximum spin speed of the wash program. You can select a lower spin speed. Start the final spin with the "Start/Stop" **G** button.

- To finish the program:

Press the "Door" button. The water will be drained away.

- Use the "Door" button to open the door.

No spin

- Select "No spin".

The laundry is not spun after the final rinse, but the water is drained away. After the drain cycle, the washer goes immediately into the anti-crease cycle. Spinning between these rinses is also omitted in this setting. If "No spin" is selected in the programs "Sturdy" and "Custom", an extra rinse cycle is added.

Using the washer

6. Add detergent

For optimum wash results, it is important to use the correct amount of detergent.

Too little detergent may cause

- Ineffective cleaning of laundry; fabrics may become gray and stiff over time.
- Grease stains on the laundry.
- Hard water deposits on the heating element.

Too much detergent may cause

- Oversudsing with minimal drum movement; poor wash, rinse and spin results.
- Higher water consumption through an automatic, additional rinse cycle.
- Higher environmental burden.

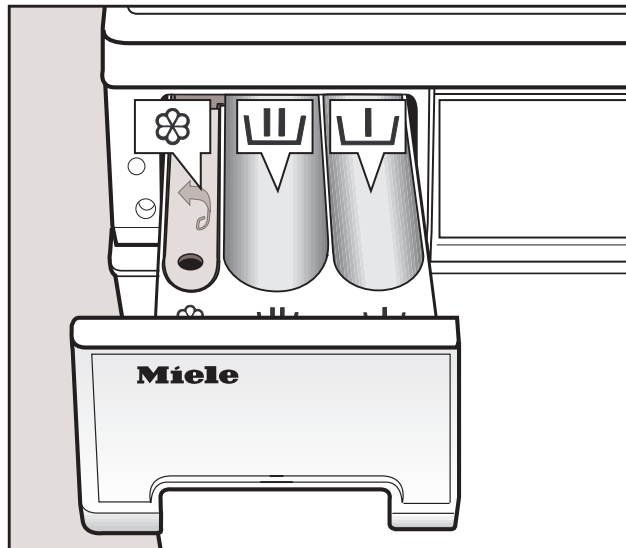

- Pull out the detergent dispenser drawer and add detergent to the compartments.

 = Detergent for the main wash

 = Only add detergent ($\frac{1}{4}$ of the total recommended amount of detergent) to this compartment if the "Heavy Soil" wash option is selected.

 = Fabric softener or liquid starch.

- Close the detergent dispenser drawer.

 Do not use detergents containing chemical solvents.

Use only high-efficiency, low sudsing laundry detergent formulated for front loading washing machines.

For wool and wool blend fabrics, use a detergent specially formulated for woolens.

Follow instructions on the detergent packaging for the correct use and amount of detergent. Adjust the amount of detergent if the load is smaller or more or less soiled than normal.

Add detergent to the main wash compartment  at the beginning of each wash program.

Only add detergent ($\frac{1}{4}$ total recommended amount) to compartment  if the "Heavy Soil" option was selected.

- If you are using liquid detergent and select the "Heavy Soil" option, use the **liquid detergent insert** in the main wash compartment . This will prevent the detergent for the main wash from being used during the prewash.

 Do not use chlorine bleach!

The amount of detergent used depends on the level of soiling:

Light soiling

No soiling or stains are visible.

Normal soiling

Some visible soiling or a few light stains.

Heavy soiling

Very visible soiling or stains.

The size of the load and the water hardness level in your area have an impact on the amount of detergent necessary to obtain optimum wash results. If you do not know the water level hardness in your area, contact your local water authority.

Detergent

Water hardness

Hardness level	Water quality	Water hardness in mmol/l	German hardness °d
I	soft	0 - 1.3	0 - 7
II	moderate	1.3 - 2.5	7 - 14
III	hard to very hard	over 2.5	over 14

Water softener

If the water hardness level is between II and III, you can soften the water to reduce detergent consumption.

The detergent packaging should indicate the correct amount to use in your machine. Add the detergent, then add the water softener. You can then use the recommended amount of detergent for water hardness level I.

Fabric softener

Fabric softener added to the wash program will make fabrics feel softer and will reduce static cling in the dryer.

- Open the lid of the fabric softener compartment ☼.

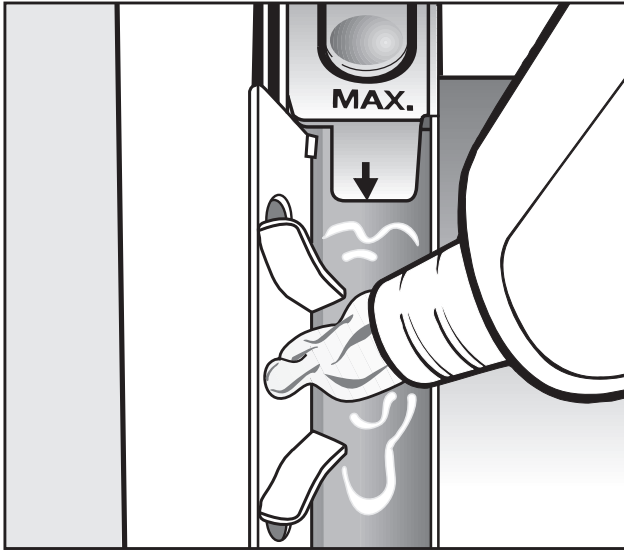

- Pour the amount of liquid fabric softener into the compartment according to the manufacturer's instructions. **Do not exceed the maximum fill level** marked inside the compartment, as the excess will prematurely activate the siphon and be wasted.
- Close the compartment lid and push in the dispenser drawer.

The fabric softener will automatically be dispensed during the final rinse cycle. A small amount of water will remain in the compartment at the end of the program.

Never mix fabric softener and starch together in the fabric softener compartment ☼. This will clog the dispenser.

Detergent

Starch

Mild liquid starch is a synthetic starch wash used to give fabrics some stiffness. Starching can be included in any wash program as part of the final rinse.

- Open the fabric softener compartment .

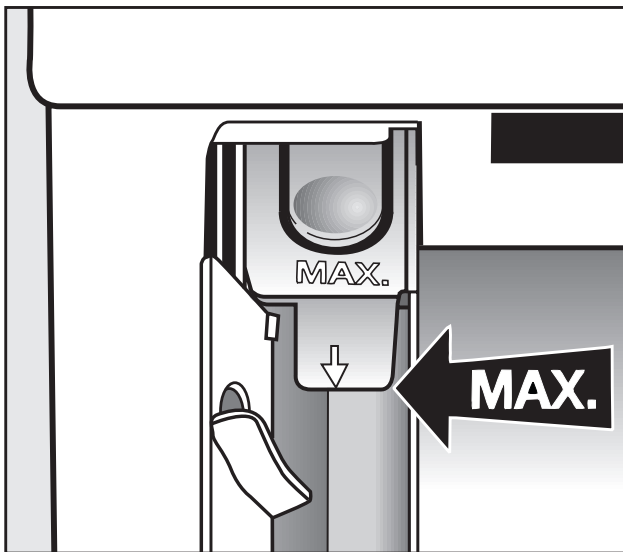

- Add the recommended amount of starch to the compartment.
Do not exceed the maximum level mark.
- Close the compartment lid and push in the dispenser drawer.
- The starch will be dispensed during the final rinse.

At the end of the program, a small amount of water will remain in the fabric softener compartment.

Fabric dye

Do not use fabric dyes in this washer!

7. Select Delay Start (if needed)

If you wish, the start of the wash program can be delayed to take advantage of lower energy rates, or to have a load completed at a later time. Delay start allows you to delay the start of a program from 30 minutes to a maximum of 24 hours.

- Press the "Delay Start" button. The Delay Start time will be extended with each press of the button.
- For less than a 10 hour delay, the delay time extends in 30 minute increments.
- For more than a 10 hour delay, the delay time extends in 1 hour increments.

Cancelling Delay Start

- If the display shows 24, press "Delay Start" again.

8. Start the program

- Press the flashing "Start/Stop  " button to begin the program.

The display shows the maximum program run time. It will count down in minutes. For the first 10 minutes, the washer calculates the water absorbency of the laundry. The overall program time might be shortened or lengthened.

9. Activate the program lock (if necessary)

- Press the "START" button until the "Child Lock" indicator lights up.

See "Locking the washer" for further details.

Using the washer

10. Remove the laundry

The "Status" indicator "Anti-Crease / End" will be displayed at the end of a program.

- Use the "Door" button to open the drum door.

Do not attempt to remove laundry from the washer if the drum is turning. You may seriously injure yourself. If the drum turns with the door open, contact Miele's Technical Service Department.

- Remove the laundry.

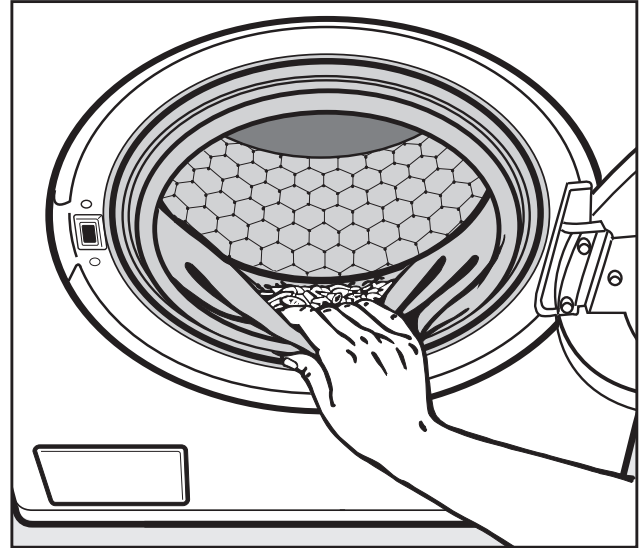

- Check the folds of the door seal for any small articles which may have been trapped.

Check the drum for any missed pieces of laundry. Items inadvertently left in the washer may be damaged (e.g. shrink or discolor) during the next wash cycle.

- Turn the washer off using the "On/Off" button.
- Close the drum door.

Cancelling a program

You can cancel a wash program any time after a program starts.

- Press the "Start/Stop  " button.

The washer drains the wash water away and the program is cancelled.

To add or remove laundry

- Press the "Door" button.

To select another program

- Turn off the washer using the "On/Off" button.
- Turn on the washer using the "On/Off" button.

Interrupting a program

- Turn off the washer using the "On/Off" button.

To continue the program

- Turn on the washer using the "On/Off" button.

Making changes to the program

- A program change is not possible after a program has started. To select a different program, the started program must be canceled.
- The buzzer can be turned on or off.
- A spin speed can be selected until the final spin speed start.

No changes can be made if the program lock is activated.

Using the washer

Adding/removing laundry during a wash program

You can interrupt the following programs to add or remove a piece of laundry:

- Normal
- Wrinkle-free
- Sturdy
- Use the "Door" button to open the door.
- Add or remove the piece of laundry.
- Close the drum door.

The program will continue automatically.

Note

Once the program has started, the washer cannot make adjustments for the load size.

After adding or removing laundry, the washer will default to the water and electrical consumption of a full load.

The time remaining will automatically adjust.

The drum door cannot be opened if:

- the water temperature is greater than **130°F (55°C)**.
- the water level is too high.
- the final spin speed has started.
- the program lock is activated.

If you press the "Door" button during any of these conditions, the "Child Lock" indicator will light.

Electronic program lock

The program lock prevents the washer from being opened or the program, temperature or spin speed from being changed during a wash program.

To activate the program lock

- Once the wash program has started, hold the "Start/Stop  " button until the "Child Lock" indicator illuminates.

The program lock is now activated. The washer can no longer accept program changes.

At the end of the program, the program lock is automatically unlocked.

To cancel the program lock

- Hold the "Start/Stop  " button until the "Child Lock" indicator goes out.

Child Safety Lock

The Child Safety Lock can be activated to prevent a child from climbing inside the washer.

When the Child Safety Lock is activated, the drum door cannot be opened and a program cannot be started.

To activate the Child Safety Lock

Before activating the lock:

- The washer must be turned off.
- The drum door must be closed.

- 1.** Press and hold the "Sensitive" and "TEMP" buttons until step **4**.
- 2.** Turn on the washer using the "On/Off" button.
- 3.** Press the "Extended / Heavy Soil / Soak" button three times.
- 4.** Release the "Sensitive" and "TEMP" buttons.

The "Child lock" indicator flashes.

- 5.** Turn off the washer with the "On/Off" button.

To deactivate the Child Safety Lock

Repeat steps **1.** through **4.**

The "Child Lock" indicator goes out.

Washer care

 Before cleaning the appliance, disconnect the power supply by unplugging the unit or manually tripping the circuit breaker.

Cleaning the washer

- Clean the exterior of the washer with a mild solution of non-abrasive detergent or soap and water. Wipe dry with a soft cloth.
- Clean the drum with a stainless steel cleaner specially formulated for use in a washing machine. This type of cleaner is available from Miele's Technical Service Department.

Cleaning the detergent drawer

Detergent residue should be cleaned out regularly.

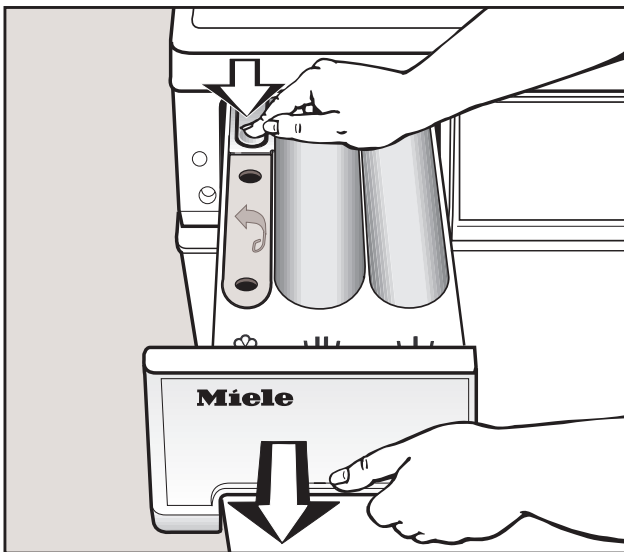

- Pull out the detergent drawer as far as it will go. Press down on the red release lever and pull the drawer out of the machine.
- Clean the detergent drawer with warm water.

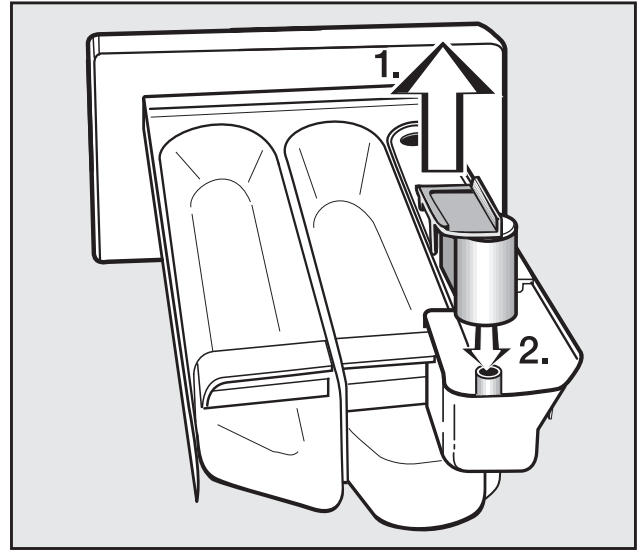

- Clean the siphon tube.
 1. Remove the siphon tube from the fabric softener compartment  and rinse under warm water. Clean the pipe on which the siphon tube is attached.
 2. Replace the siphon tube.

 Do not use chemical solvents, abrasive cleaners, glass or all purpose cleaners. These can damage plastic surfaces and other parts.

Cleaning the drain pump

Occasionally, small objects (buttons, coins, etc.) may become trapped in the lint trap. If the machine does not drain completely, the lint trap should be checked to ensure that it is free of foreign objects.

- Turn off the appliance with the "On/Off" button.

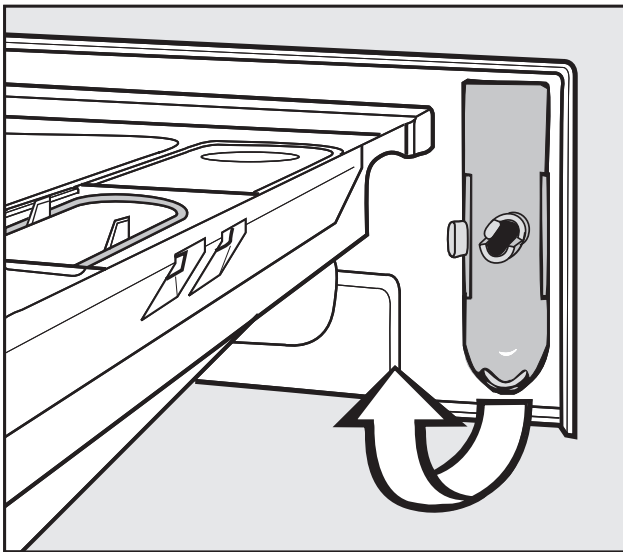

- To clean the lint trap, remove the tool from behind the detergent dispenser drawer.

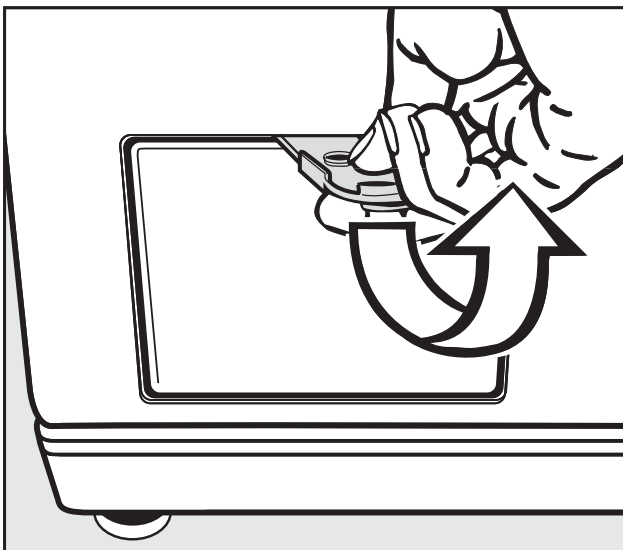

- Open the drain filter door.

If the main drain hose is clogged, water will be retained in the machine (**a maximum amount of 6.5 gal [25 l]**).

 Caution: If laundry has been washed at a high temperature, the water draining out of the machine will still be hot! Allow it to cool before proceeding.



- Turn the lint trap lid counterclockwise. Do **not** remove it. About 2 quarts of water will drain out of the hose.

If additional water remains in the machine, tighten the lint trap lid and empty the container. Repeat this procedure as often as necessary.

Washer care

Once the flow of water stops:

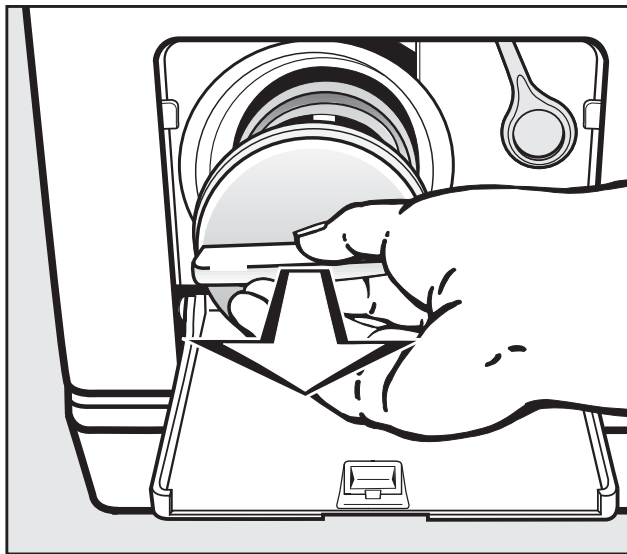

- Remove the drain filter lid.
- Remove any foreign objects or lint from the filter.

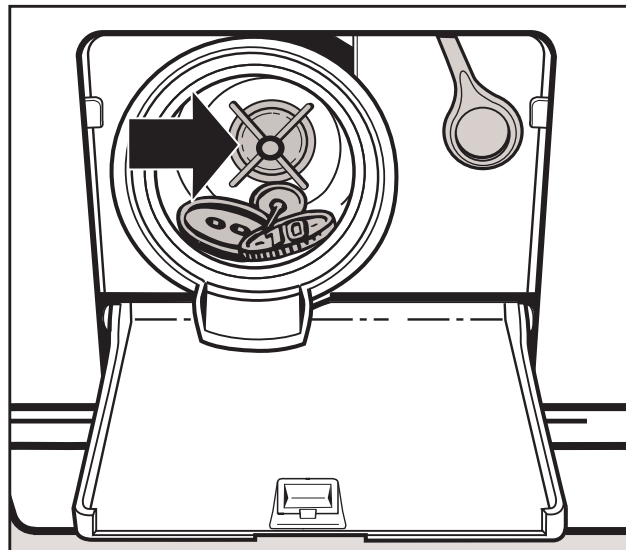

- Check that the drain pump impeller (in the back of the chamber) rotates freely by spinning with your hand.
- Return the drain filter and tighten into place.

 If the drain filter is not tightened securely, water will leak out when the machine is used.

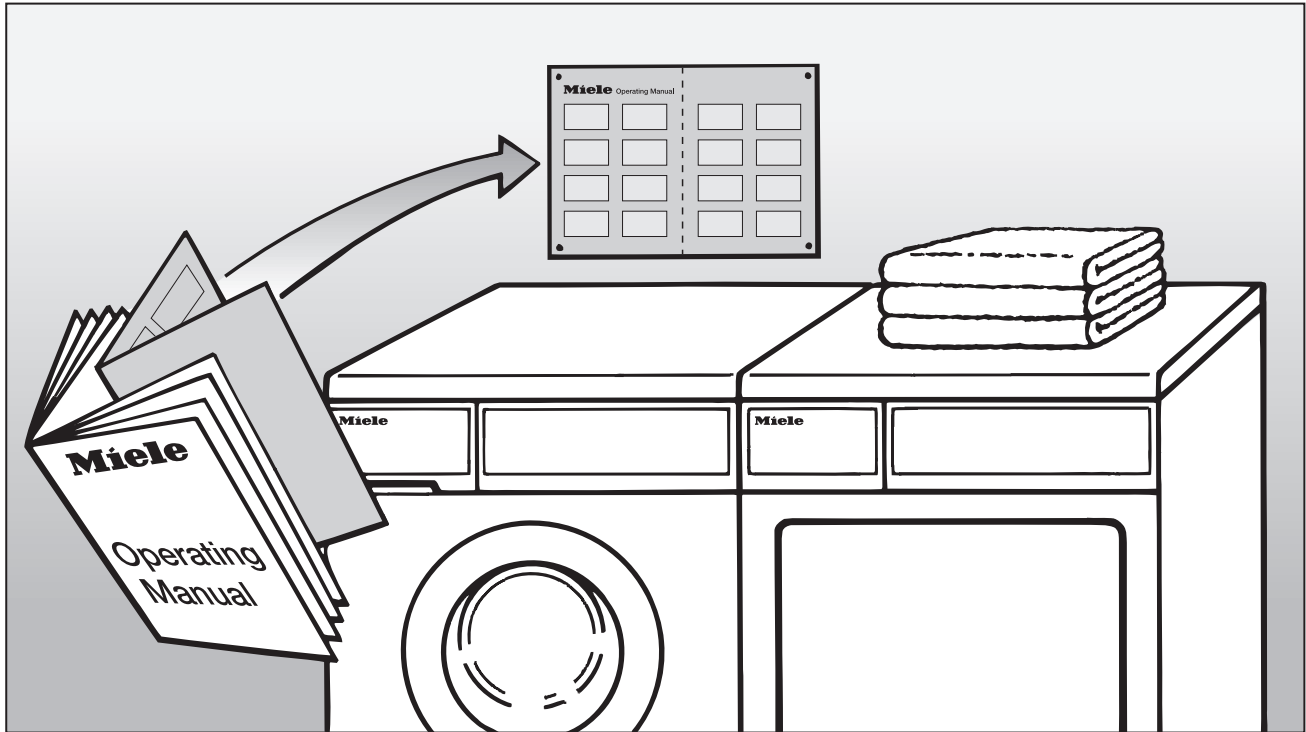

Quick Guide

Remove this guide for easy reference

Please read all instructions, especially the "Important Safety Instructions", **before** using the washer.

Quick Guide

1. Sort the laundry.

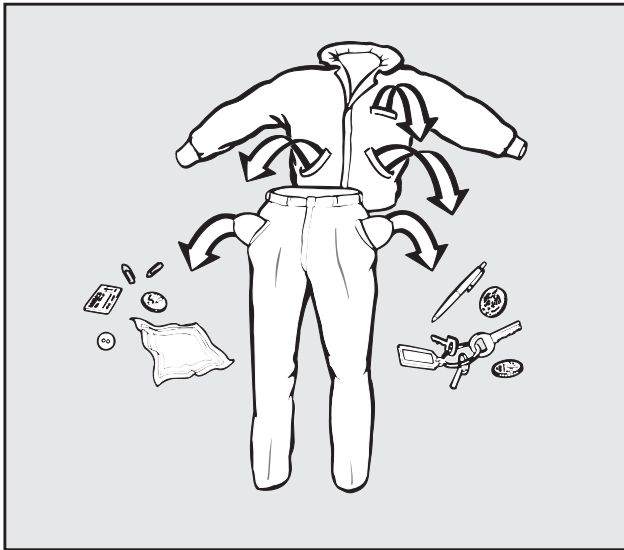

- Empty all pockets.
- Sort the laundry by fabric and color.
- Pretreat stains.

2. Load the laundry



- Turn on the washer using the "On/Off" button.



- Open the drum door by using the "Door" button.
- Load the laundry.
- Close the drum door.

Make sure clothes will not be caught by the door.

3. Select a program



- Select a desired program.

Refer to the "Program guide" to determine which program is most suitable for the load being washed.

4. Select wash options (if needed)

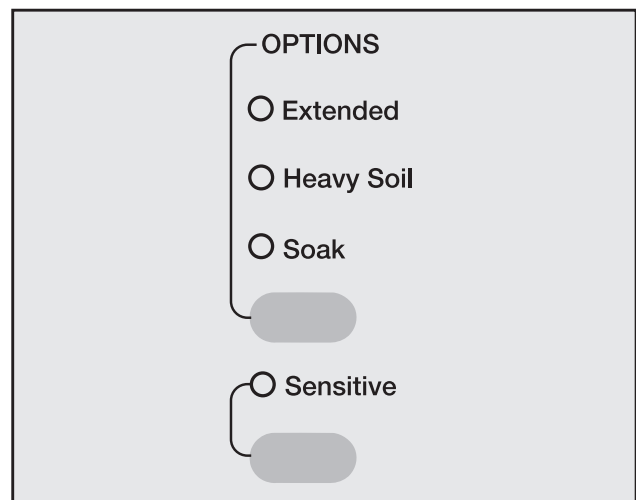

- Press the upper button until the indicator of the desired wash option lights.
- Press the lower button to select the "Sensitive" wash option.

5. Select the temperature and spin speed

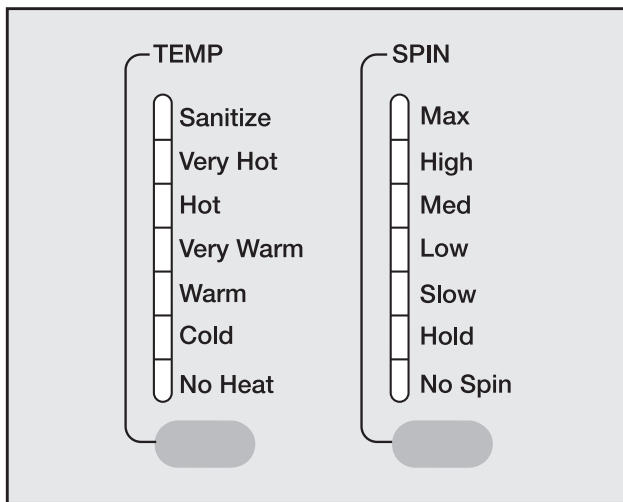

- Press the "TEMP" and "SPIN" buttons until the indicator of the desired value lights.

6. Add detergent

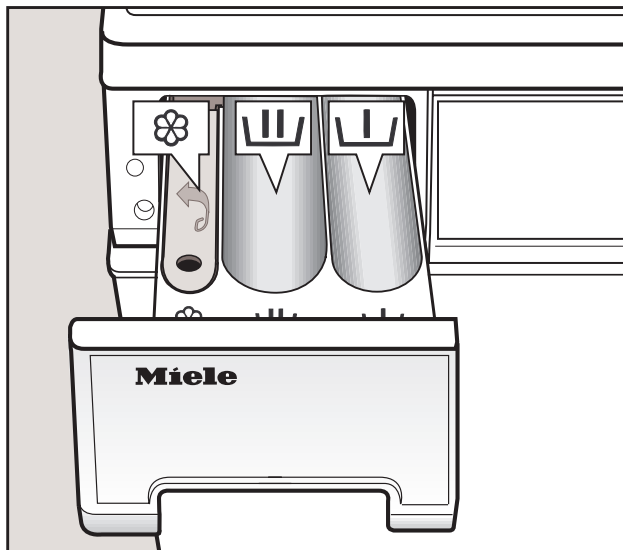

- Place the recommended amount of detergent into the main wash compartment **U**. If "Heavy Soil" is selected, add 1/4 of the total amount of detergent to the **U** compartment. Place fabric softener or liquid starch in compartment **⊗**.

7. Select Delay Start (if needed)



- Press the "Delay Start" button.

8. Start the program



- Press the "Start/Stop" **⏻** button.

9. Activate the program lock (if necessary)



- Hold the "START" button until the "Child Lock" indicator lights up.

10. Unload the laundry

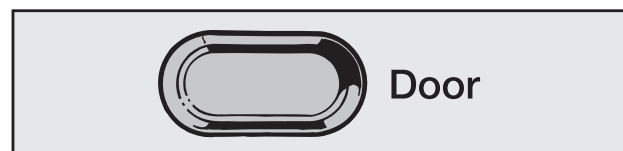

- Open the drum door using the "Door" button.
- Remove the laundry.





- Turn off the washer using the "On/Off" button.
- Close the drum door.

Quick Guide

Program guide

Normal
Options: Extended, Heavy Soil, Soak, Sensitive
Temperatures: Hot 60, Very Warm 50/30, Warm 40/30, Cold 30/30, No Heat 30
Spin speeds: Max, High
Items: For a quick load of colorfast items.
Wrinkle Free
Options: Extended, Heavy Soil, Soak, Sensitive
Temperatures: Hot 60, Very Warm 50/30, Warm 40/30, Cold 30/30, No Heat 30
Spin speed: Med
Items: For clothing that tends to wrinkle easily.
Sanitize
Options: Extended, Heavy Soil, Soak, Sensitive
Temperatures: Sanitize 95, Very Hot 75
Spin speeds: Max, High
Items: For a load of whites with special hygienic demands.
Extra White
Options: Soak, PreWash, Intensive
Temperatures: Sanitize 95, Very Hot 75, Hot 60
Spin speeds: Max, High
Items: For a quick load of white items.
Delicates
Options: Soak, Prewash, Intensive
Temperatures: Warm 40/30, Cold 30/30, No Heat 30
Spin speed: Low
Items: For delicate clothing that wrinkles easily.

Woolens 
Options: Sensitive
Temperatures: Warm 40/30, Cold 30/30, No Heat 30
Spin speed: High, Med
Items: For hand washable and machine washable wool.
Silk
Options: Sensitive
Temperatures: Cold 30/30, No Heat 30
Spin speed: Slow
Items: For silk items.
Handwash 
Options: Extended, Heavy soil, Sensitive
Temperatures: Warm 40/30, Cold 30/30, No Heat 30
Spin speed: Med
Items: For handwashable items with no wool or silk content.
Sturdy
Options: None
Temperatures: Warm 40/30, Cold 30/30, No Heat 30
Spin speeds: Med, Low
Items: For a quick, mixed load of colorfast items.
Custom
Options: Extended, Heavy Soil, Soak, Sensitive
Temperatures: Sanitize 95, Very Hot 75, Hot 60, Very Warm 50/30, Warm 40/30, Cold 30/30, No Heat 30
Spin speeds: Med, Low, Slow, Hold, No Spin
Items: All options can be selected individually for colorfast or white items.

Cleaning the water inlet filters

The washer has two water inlet filters to protect each inlet valve. These filters should be checked every 6 months and cleaned, if necessary. (This may need to be performed more frequently with some water supplies).

Cleaning the inlet hose filter

- Turn off the water valve.
- Unscrew the inlet hose from the valve by turning the connector counterclockwise using a wrench, if necessary.

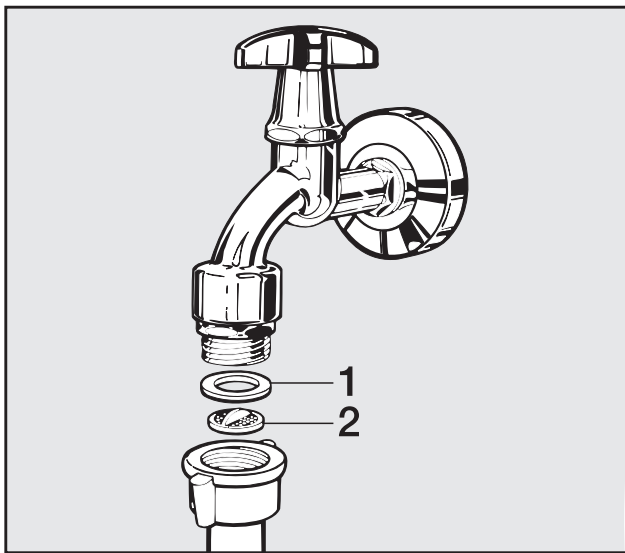

- Remove the rubber seal, **1**, from the connector.
- Using needle nose pliers, grasp the plastic filter, **2**, and pull it out of the hose connector.
- Clean the filter under running water and carefully remove any large particles. Replace the filter and seal and reconnect the hose.
- Slowly turn on the valve and check for leaks.

 Inspect the hose regularly. The hose must be in good condition to withstand high water pressure. The hose should be replaced if there are cracks in the surface, or if it has been otherwise damaged or cut.

Cleaning the filter in the inlet valve

- Using a wrench, carefully loosen and remove the plastic hose connector on the inlet valve.
- Using needle nose pliers, remove the plastic filter by pulling on the bar (see illustration). Rinse under water and return parts.

Both filters **must** be put back in place after cleaning.

Frequently asked questions

 Repairs to electrical appliances must only be carried out by a qualified and trained person in accordance with local and national safety regulations. Repairs and other work by unqualified persons could be dangerous. The manufacturer cannot be held responsible for unauthorized work.

The following section will help you avoid placing a service call by identifying issues you may encounter while operating the machine:

A wash program cannot be started		
Issue	Possible cause	Solution
The display stays blank and no indicator illuminates.	The washer has no power.	Check to determine if: – the washer is plugged in. – the circuit breaker has been tripped.
The "Child Lock" indicator flashes.	The electronic lock function is activated.	Deactivate the lock function.
The program will not start after pressing the "Start/Stop  " button.	The door is not properly closed.	Close the drum door.

Frequently asked questions

The program was interrupted and a fault message appears.		
Issue	Possible cause	Solution*
The buzzer sounds, and the "Drain" indicator flashes. "- - -". appears in the display.	The drain is blocked.	Clean the drain pump and lint trap. See "Washer care - Cleaning the drain pump and lint trap".
	The drain hose is too high.	The maximum drain pump height should not exceed 4ft. (1.2 m).
The buzzer sounds, and the "Intake" indicator flashes. "- - -". appears in the display.	The water intake is blocked.	Check to determine if: <ul style="list-style-type: none"> – the water valve is open. – the inlet hose is kinked.
	The inlet hose filter is dirty.	Clean the filter under running water and carefully remove any large particles.
The buzzer sounds, and the "Intake" and "Drain" indicators flash. "- - -". appears in the display.	There is a fault.	Call the Miele Service Department.
The buzzer sounds and the "Soak" and "Rinse" indicators flash. "- - -". appears in the display.	There is a fault.	Restart the program. If the fault message appears again, call Miele's Technical Service Department.

* To turn off the fault message: Turn off the washer using the "On/Off" button.

Frequently asked questions

General issues with the washer		
Issue	Possible cause	Solution
The "Oversudsing" indicator lights.	The machine has oversudsed.	Use less detergent in the next wash program.
The Main wash" indicator flashes.	There is a fault.	Restart the program. If the fault message appears again, call Miele's Technical Service Department.
The washer shakes during the spin cycle.	The washer's four feet are not resting evenly on the floor.	Level the machine (see Installation Instructions.)
There are unusual sounds coming from the drain pump.	There is no fault. Lapping sounds at the beginning and end of the pump process are normal.	
A large amount of detergent residue remains in the dispenser drawer.	The water pressure is too low.	<ul style="list-style-type: none"> – Clean the water intake hose filter under running water and carefully remove any large particles. – Select the "Sensitive" button.
The fabric softener is not completely dispensed, or too much water remains in the fabric softener compartment ☼.	The siphon tube is incorrectly positioned or clogged.	Clean the siphon tube (see "Cleaning and care- "Cleaning the detergent dispenser drawer").

Frequently asked questions

Poor wash results

Issue	Possible cause	Solution
The wash does not come clean with liquid detergent.	Liquid detergents do not contain bleaching agents. Fruit, coffee or tea stains cannot be effectively removed.	<ul style="list-style-type: none">– Use powdered bleach.– Do not put liquid detergent and stain remover together in the same washcompartment.
Laundry has a gray, sticky residue.	An inadequate amount of detergent was used to dissolve greasy deposits in heavily soiled laundry (e.g. grease, oils or lotion stains).	<ul style="list-style-type: none">– Add more detergent to the laundry or use a liquid detergent.– Run a "Normal - Hot" program with liquid detergent to clean the washer before using it for laundry again.
There is white detergent residue on dark laundry.	The detergent was not completely dissolved because of hard water.	<ul style="list-style-type: none">– After drying, remove white residue with a clothing brush.– Add a water softener to the detergent for future loads.

Frequently asked questions

The door will not open when the "Door" button is pressed.	
Possible cause	Solution
The washer is not hooked up to electricity.	Insert the plug into the outlet.
The washer is not turned on.	Turn on the washer using the "On/Off" button.
The program lock is activated.	Deactivate the program lock as described in "Locking the washer - Electronic program lock".
The Child Lock function is activated.	Deactivate the Child Safety Lock as described in "Locking the washer - Child Safety Lock".
Power failure	To open the the drum door, see "Frequently asked questions - Opening the drum door during a power failure."
The door was not properly closed.	Push on the drum door and at the same time, press the "Door" button.
There is still water in the drum and the washer cannot drain it away.	Clean the drain filter and the drain pump as described in "Cleaning and Care - Cleaning the drain pump".
As a safeguard against scalding, the drum door cannot be opened if the wash water temperature is over 130°F (55°C).	

Opening the drum door during a power failure

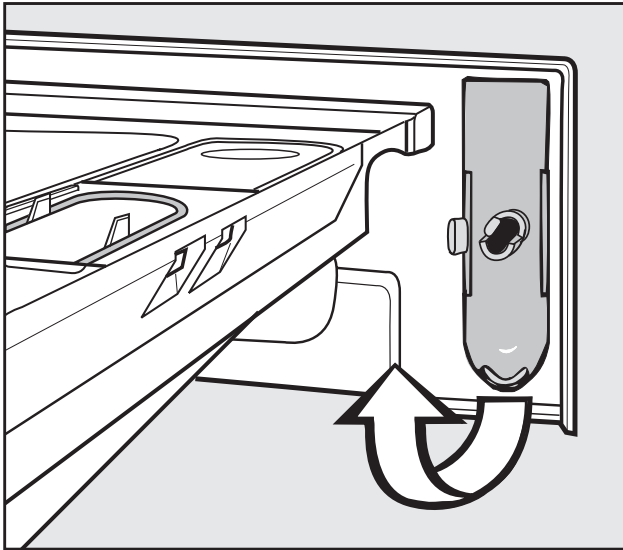

- Open the detergent dispenser drawer.
- Remove the tool.

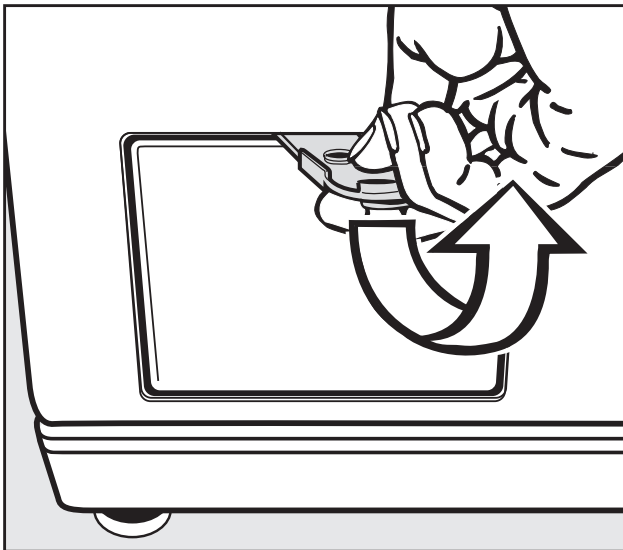

- Open the lint trap door.
- Drain the water from the washer as described in "Washer care / Cleaning the drain pump and lint trap."

⚠ Make sure the machine is turned off and the drum has stopped turning. A moving drum is dangerous.

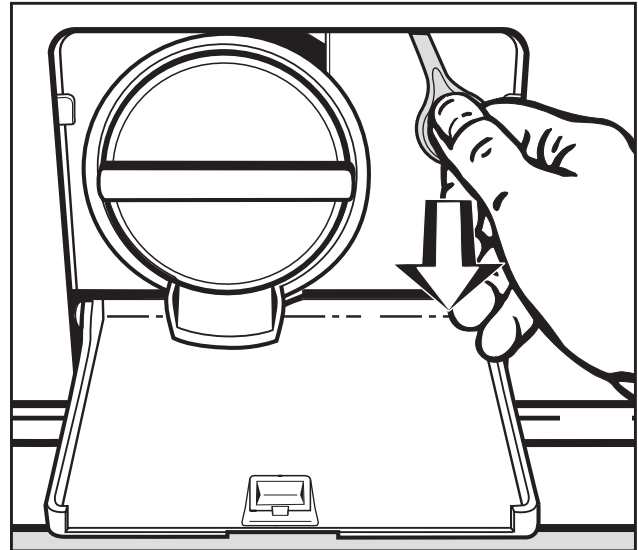

- To open the door, pull down on the ring in the upper right corner of the access area.

Technical Service

Repairs

In the event of any faults which you cannot fix yourself, please contact the Miele Technical Service Department

USA 1-800-999-1360
techserv@mieleusa.com

CDN/F 1 800 565-6435
service@miele.ca

When contacting the Technical Service Department, please quote the model and serial number of your appliance. Both can be found on the dataplate visible above the front glass on the inside of the door.

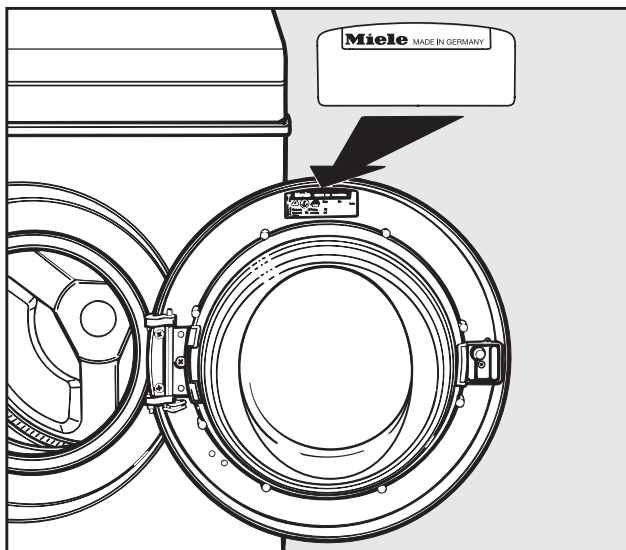

PC Update

The indicator marked PC allows a technician to make use of new technology if new programs are developed or new fabrics are introduced.

Warranty terms

The washer is covered by the warranty for 2 years from the date of installation. See the Warranty booklet for details.

Optional accessories

Optional accessories are available at your Miele dealer or through Miele's Technical Service Department.

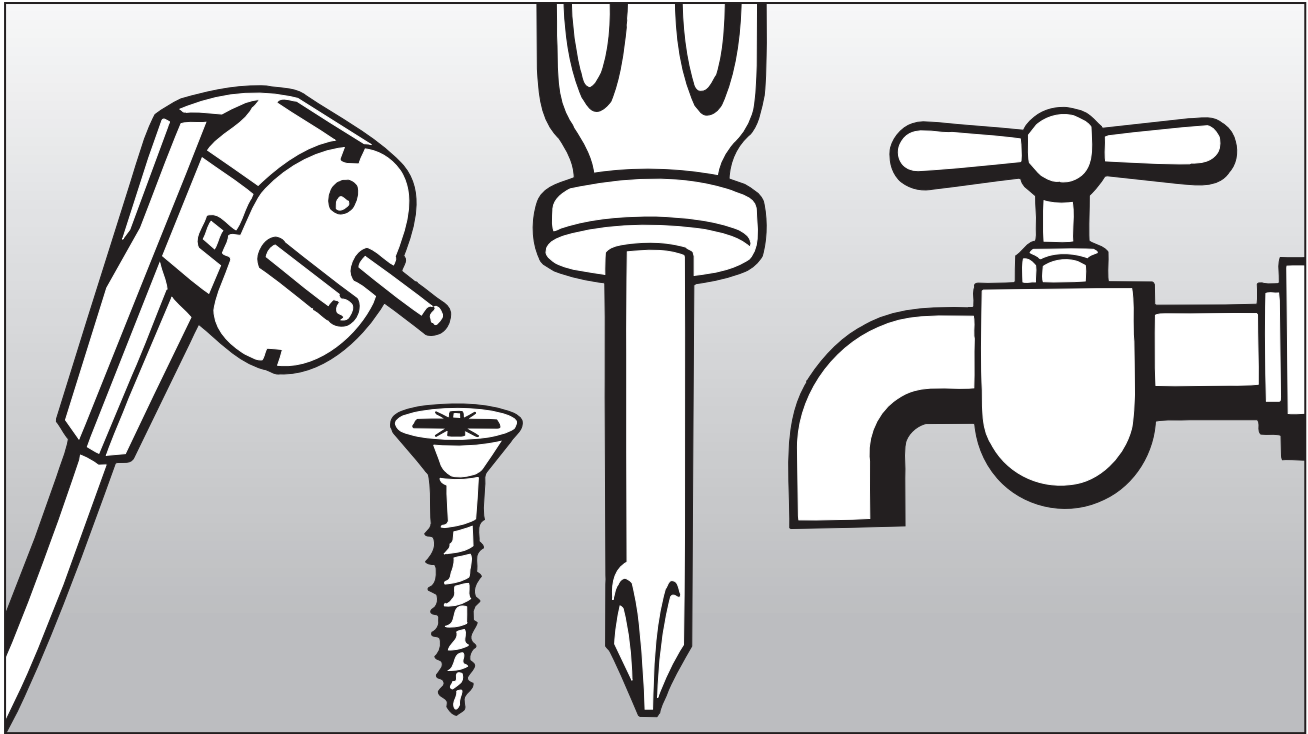

INSTALLATION INSTRUCTIONS

Help protect our environment

Disposal of the packing material

The cardboard box and packing materials protect the appliance during shipping. They have been designed to be biodegradable and recyclable.

Ensure that any plastic wrappings, bags, etc. are disposed of safely and kept out of the reach of children, as they pose a danger of suffocation.

Disposal of an appliance

Old appliances may contain materials that can be recycled. Please contact your local recycling authority about the possibility of recycling these materials.

Ensure that the appliance presents no danger to children while being stored for disposal. Before discarding an appliance, unplug it from the outlet, cut off its power cord and remove any doors to prevent hazards.

Front view

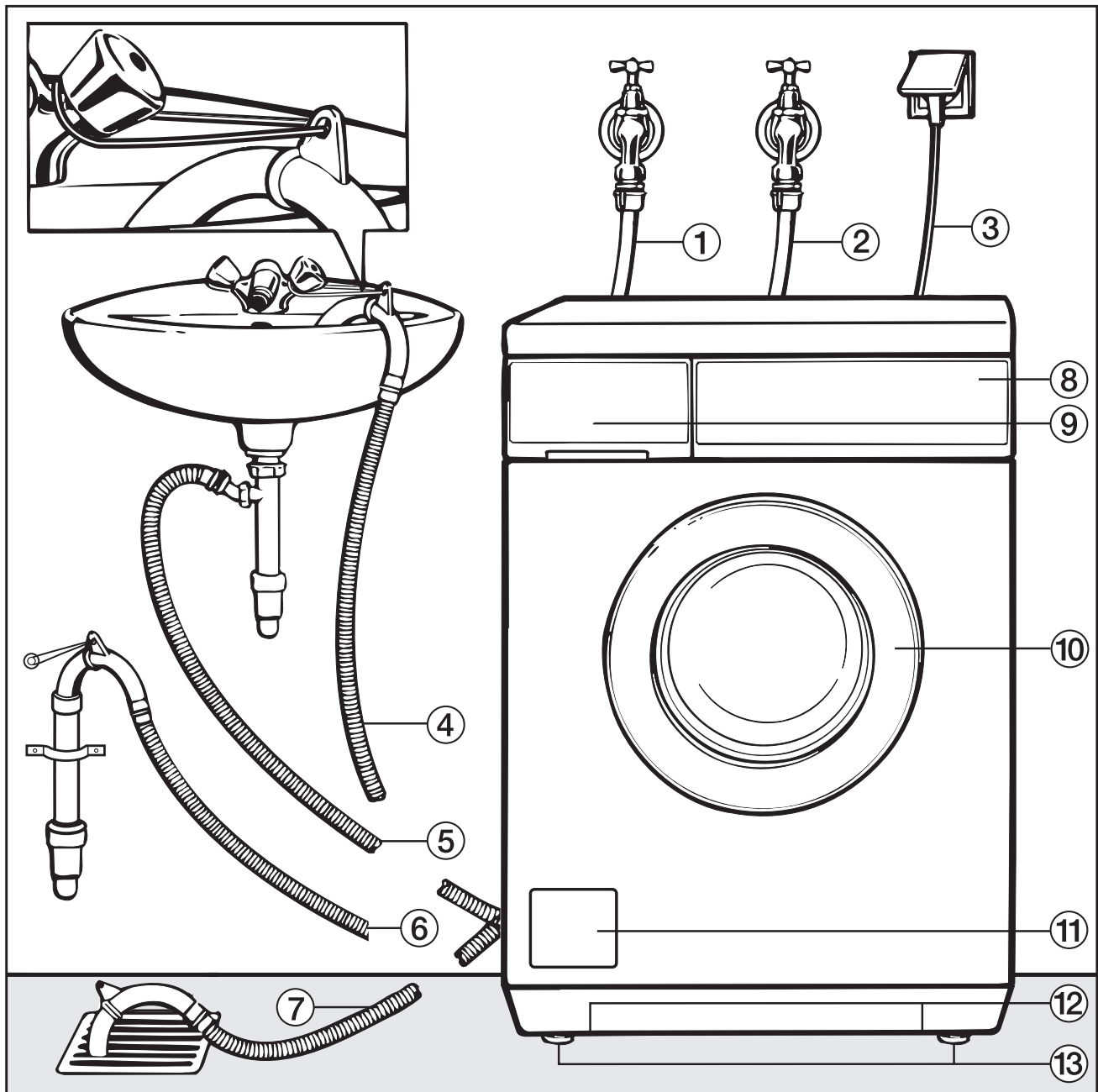

- ① Hot water intake hose
- ② Cold water intake hose
- ③ Power cord
- ④ - ⑦ Drain hose (with adjustable and removable elbow) showing drain options
- ⑧ Control panel
- ⑨ Detergent dispenser drawer
- ⑩ Drum door
- ⑪ Access panel to drain filter and drain pump
- ⑫ Recessed grip
- ⑬ Four height- adjustable feet

Installation

Back view

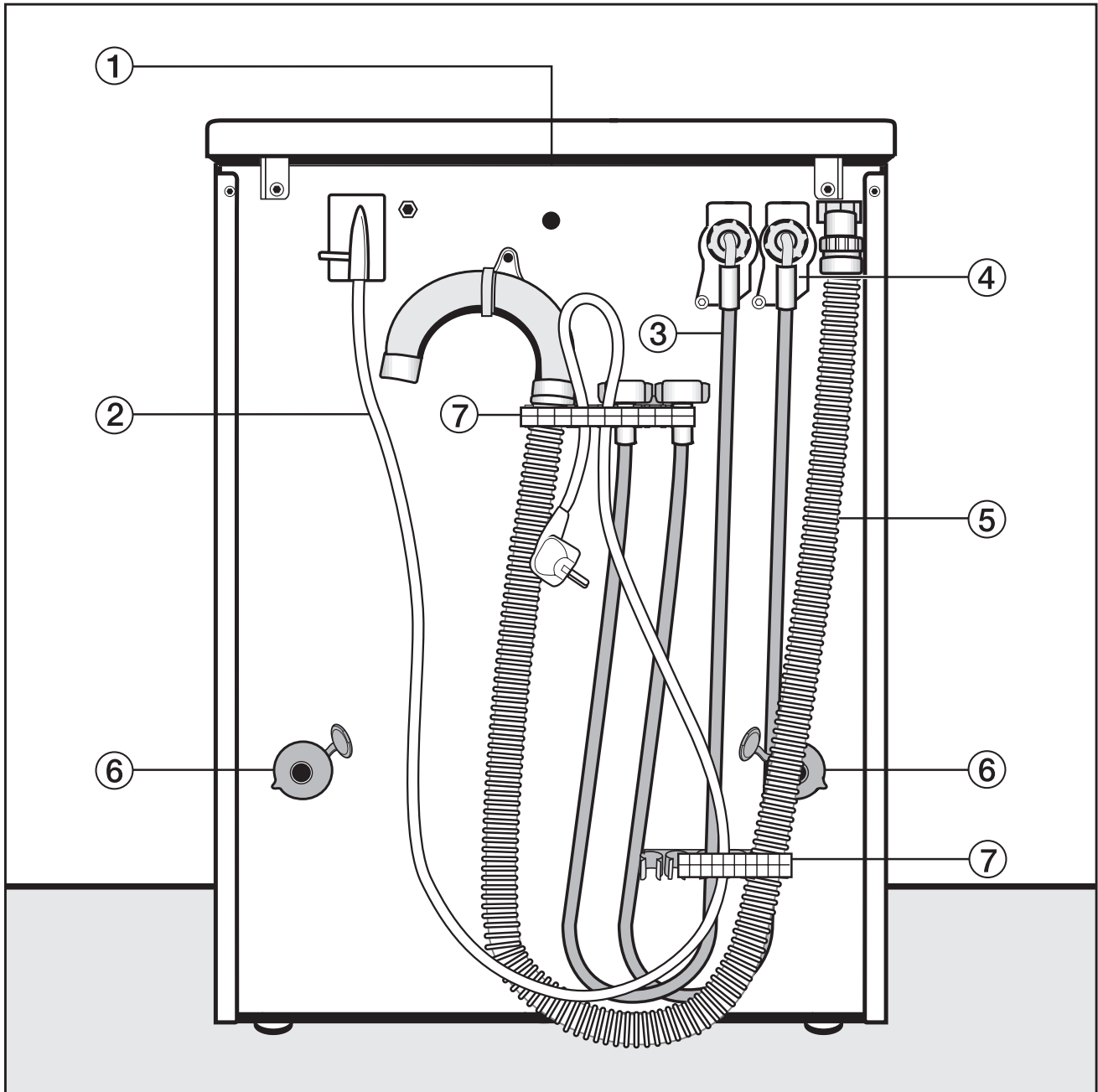

① Lid excess end with transport grips

② Power cord

③ Cold water intake hose

④ Hot water intake hose

⑤ Drain hose

⑥ Shipping struts with rotary protection

⑦ Mounting for:

– Water intake hose

– Drain hose

– Power cord

– Shipping struts

Installation site

A concrete or reinforced floor is the most suitable surface for the washer. These types of floors are less prone to vibration during the spin cycle.

Note:

- The machine must be leveled and securely positioned.
- To avoid vibration while spinning, the machine should not be installed on soft floor coverings.

If the installation must be performed on a wooden floor:

- Install the unit on a $23 \frac{1}{4}'' \times 20 \frac{1}{2}'' \times 1 \frac{3}{16}''$ (59 x 52 x 3 cm) plywood base. Ideally, the base should be large enough to span several joists, and should be anchored to the joists, not just the floor boards.

It is best to install the washer in the corner of a room, where the stability of the floor is at its greatest.

 If the machine is installed on a raised platform, it must be secured with retaining clips. These clips are available from your dealer or the Miele Technical Service Department. If installed on a masonry or concrete base, the base should have a $\frac{1}{2}''$ to $\frac{3}{4}''$ (12-20 mm) high rim. This is required to prevent the washer from vibrating off the stand during the spin cycle.

Installation

Installation

- Lift the machine from its shipping pallet and move it to the installation site.

Do not lift the washer by the drum door!

 Ensure that the machine's feet and the floor are dry to prevent slippage during the spin cycle.

Remove the shipping struts

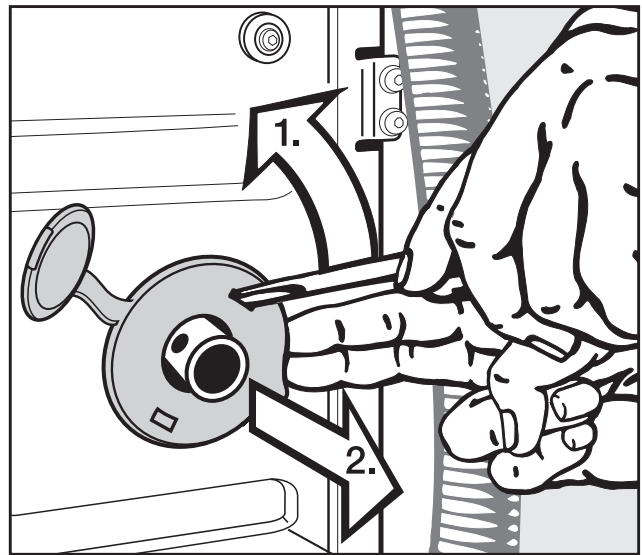

- Remove the left and right rotary protection.
1. Unhook the rotary protection with a screw driver.
 2. Remove the rotary protection.

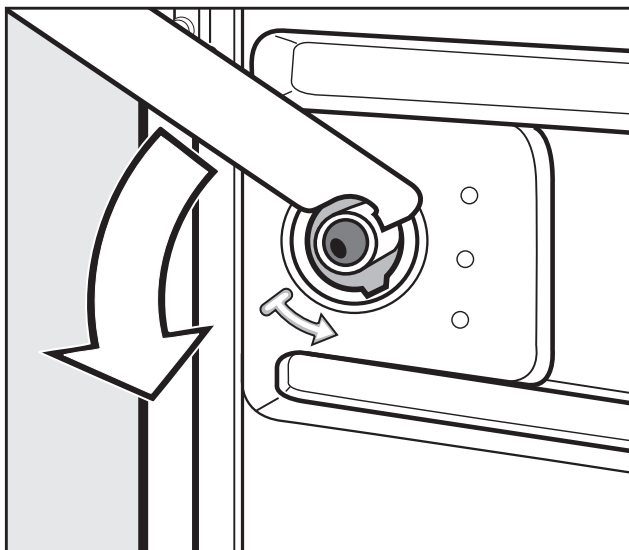

- Turn the left shipping strut counterclockwise 90° with the enclosed combination wrench.

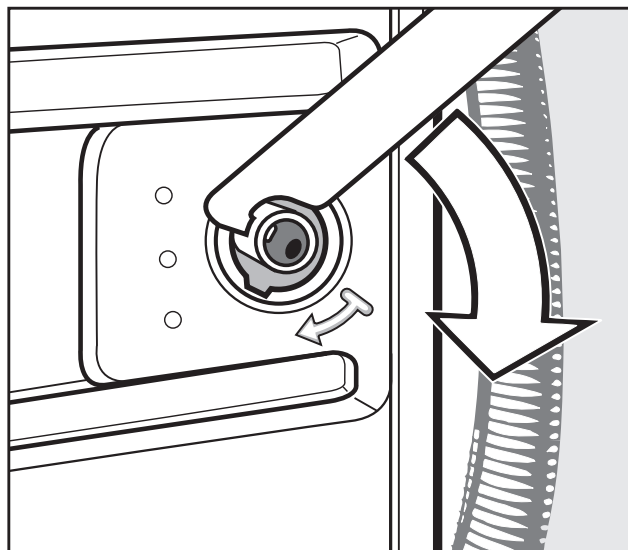

- Turn the right shipping strut counterclockwise 90° with the enclosed combination wrench.

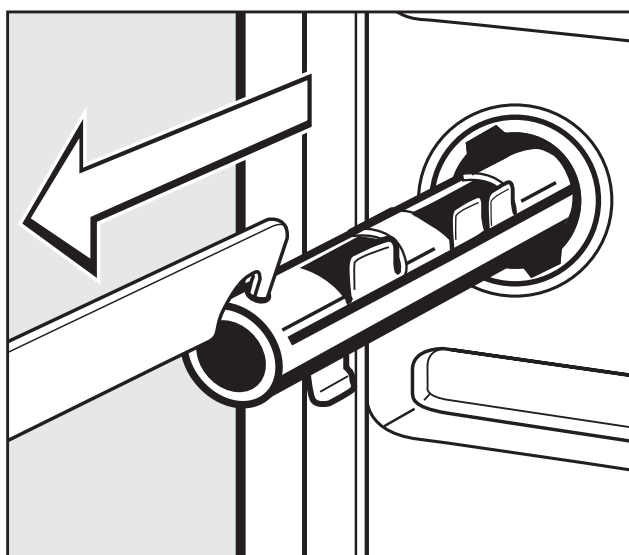

- Pull out the shipping strut.

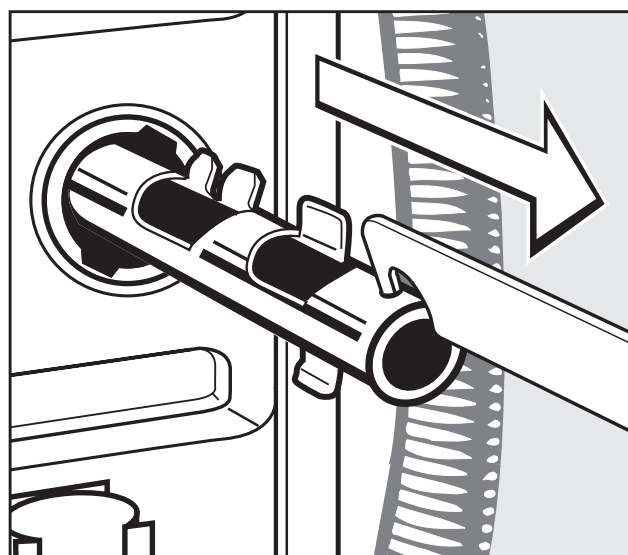

- Pull out the shipping strut.

Installation

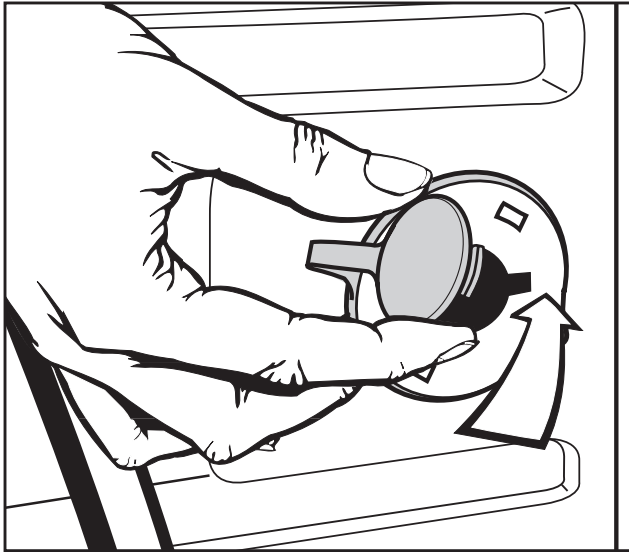

Installing the shipping struts

Reinstall the struts by reversing the above procedure.

- Close the holes with the rotary protection and their caps.

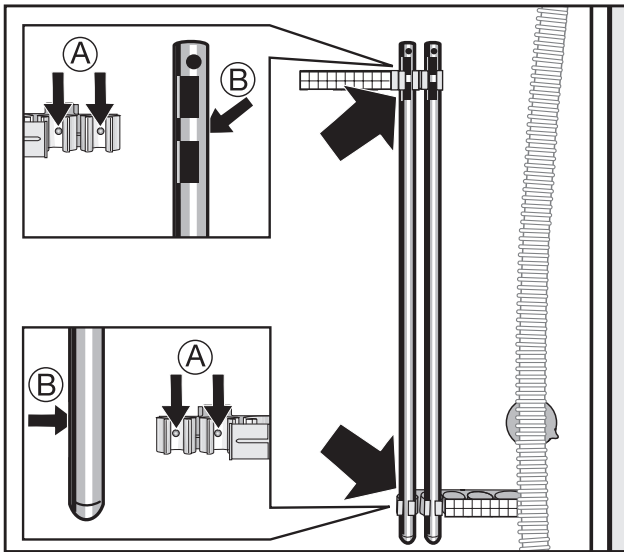

- Fasten the shipping struts at the rear side of the washer. Take care to insert the drill holes **(B)** onto the spigot **(A)**.

⚠ Do not move the washer without the shipping struts in place. The shipping struts should be stored in a safe place for future use. They must be reinstalled before moving the machine.

Level the washer

To ensure smooth operation, the washer must be level.

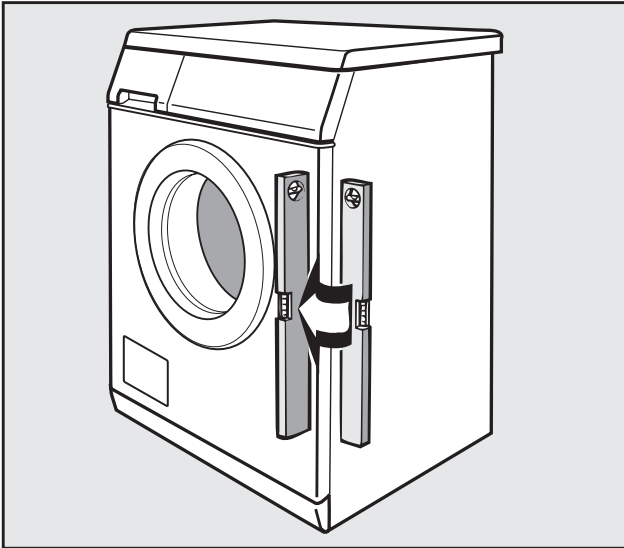

Failure to level the machine can result in increased water and energy consumption, loud noise during the spin cycle or "walking" across the floor during use.

Adjust the four leveling feet

The washer is levelled by adjusting the four feet:

- Tip the machine slightly and place a support, such as a block of wood, underneath it.
- Unscrew each of the four feet as much as necessary by turning both the foot, **1**, as well as the locking ring, **2**, to the left using a screwdriver.

 **CAUTION:** The washer is extremely heavy. When tipping the machine, be careful that it does not slip.

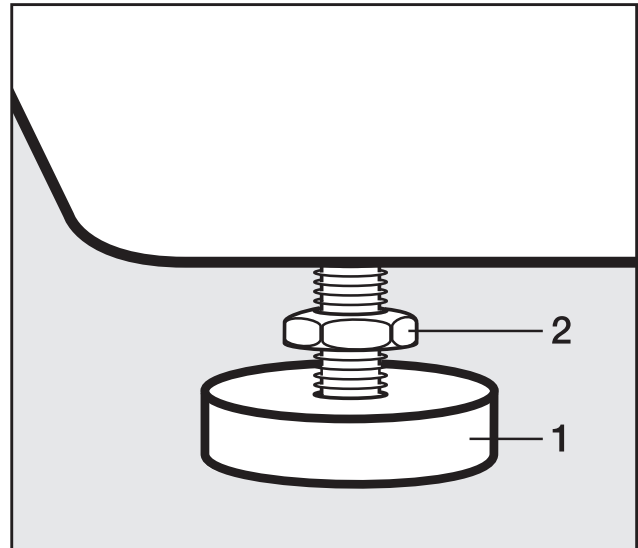

- Turn the locking ring, **2**, counterclockwise with the enclosed combination wrench. Unscrew each of the four feet as much as necessary by turning both the foot, **1**, as well as the locking ring, **2**, to the left.
- Check that the machine stands level.
- Once level, hold the foot, **1**, immobile with a wrench. Turn the locking ring, **2**, with the combination wrench towards the machine.

 All four locking rings must be tight against the bottom of the machine. In addition, check to see that the feet were not inadvertently unscrewed while tightening the rings. Running a machine that is not level or whose feet are not tight may cause damage to both the machine and its surrounding area.

Installation

Installation beneath a counter

If a countertop is placed over the washer, at least a $\frac{1}{4}$ " gap must be left between the top of the machine and bottom of the countertop; nothing should be within $\frac{1}{2}$ " of any other side of the washing machine.

- When the machine lid needs to be removed to reduce the height of the machine, a **countertop kit*** is necessary. The cover plate in the countertop kit replaces the machine lid and ensures electrical safety.
- A filler frame* is recommended at a countertop height of $35 \frac{7}{16}$ " to $35 \frac{13}{16}$ " (90-91 cm)
- Water intake, drain and electrical connections should be installed near the machine and be easily accessible.

An installation manual is supplied with the countertop kit.

(* available from your Miele dealer or Miele's Technical Service Department).

Washer stand with drawer

A washer stand is available to raise the machine for convenience. It has a drawer to store cleaning essentials.

The stand can be purchased as an optional accessory.

Washer/ Dryer Stack

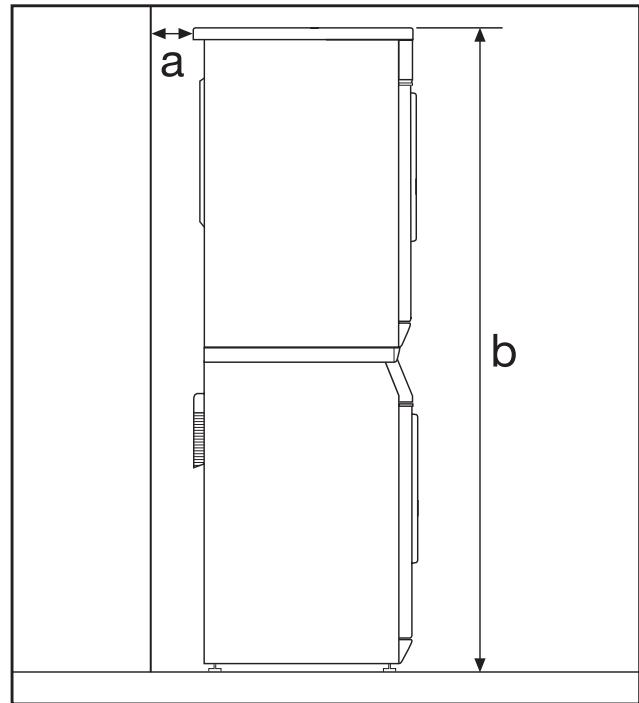

The Miele washing machine can be installed as part of a washer-dryer stack in combination with a Miele tumble dryer. An appropriate "stacking kit" is required (part # 12 996 026).

(* available from your Miele dealer or Miele's Technical Service Department.)

Note:

- a** Safety distance to the wall:
minimum $\frac{13}{16}$ " (2 cm)
- b** Height:
Stacking kit with pull out shelf
 $66 \frac{15}{16}$ " (170 cm)

Reinstallation of the machine lid

When reinstalling the machine lid, check the fit of the cover at the rear bracket to ensure safe transport.

The washing machine can be connected to a potable water supply. A non-return valve is not required unless required by building code.

The washing machine has $\frac{1}{2}$ " pressure hoses with $\frac{3}{4}$ " female hose thread connections. If there is no water hookup, contact a plumber to install a connection. Make sure that the sealing ring is seated properly on the hose connector.

Replace the hose with a genuine Miele hose only, or with a hose able to withstand up to 145 psi (10 bar) pressure. The water valve connector must also be able to withstand 145 psi (10 bar).

 The bolted connection is pressurized by water pressure. Open the water valve slowly to check for leaks. Adjust the rubber seal and the bolted connection if necessary.

To protect the inlet valve the two filters - one at the pressure hose / valve connection and one at the the inlet connection to the solenoid valve- must not be removed.

Optional accessory hose extension

Hose extensions with a length of 8' $2\frac{7}{16}$ " to 13' $1\frac{1}{2}$ " (2.5 to 4 m) are available from your Miele dealer or Miele's Technical Service Department.

Plumbing

Water connection

Connect the cold water intake hose (blue mark) to the cold water valve and the hot water intake hose (red mark) to the hot water valve.

If the machine is being connected to a cold water supply **only**, both the hot and cold water intake hoses must be attached to the cold water valve through the use of a Y adapter (available at a hardware store). Both hoses **must** be connected to a water source, or the machine will not function properly. **Do not connect the washer to hot water only.**

Turn on the valve(s) and check for leaks. The water pressure must be within 15-145 psi (1-10 bar). If the water pressure is greater than 145 psi (10 bar), a pressure reducer must be installed. If the water pressure is below 15 psi (1 bar), there will not be enough water available for a complete fill.

The water intake hoses are equipped with screen filters. Do not remove these filters except for cleaning.

Tips for a hot water connection

– The hot water temperature from the hot water valve must not exceed 140°F; the ideal temperature is 130°F.

If there is **no** water pressure at the hot water inlet, the unit automatically switches to cold water after several minutes.

Drainage

The 5 foot drain hose may be connected as follows:

- 1. Directly into a sink:** hook the hose over the edge of the sink and secure it firmly (e.g. by tying the hose to the water faucet).
- 2. To a stand pipe:** place the drain hose into a 1 1/2" stand pipe and secure it firmly.
- 3. To a floor drain:** The machine is equipped with an airgap/anti-siphoning system so that no minimum drain height is required.

- The machine drains using a pump with a maximum delivery height of 4 feet.
- Make sure there are no kinks in the drain hose.

If desired, the drain hose may be extended to run a maximum of 16 feet, as long as the 4 feet height is not exceeded. Hose extensions are available from your dealer or Miele's Technical Service Department.

Electrical connection

GROUNDING INSTRUCTIONS

This appliance must be grounded. In the event of malfunction or breakdown, grounding will reduce the risk of electric shock by providing a path of least resistance for electric current. This appliance is equipped with a cord having an equipment-grounding conductor and a grounding plug. The plug must be plugged into an appropriate outlet that is properly installed and grounded in accordance with all local codes and ordinances.

WARNING – Improper connection of the equipment-grounding conductor can result in a risk of electric shock. Check with a qualified electrician or service representative if you are in doubt as to whether the appliance is properly grounded.

Do not modify the plug provided with the appliance; if it will not fit the outlet, have a proper outlet installed by a qualified electrician.

ELECTRICAL INSTRUCTIONS

This installation should be performed by an experienced and qualified technician, in accordance with local codes and regulations.

The washing machine is supplied with a 5' 3" long, 4 wire cord, ending in a NEMA 14-30 P plug, ready for connection to a 120/208-240 V, 15 A, 60 Hz, AC power supply.

The proper outlet can be purchased from an electrical supply dealer or from the Miele Technical Service Department (request a NEMA 14-30 R receptacle).

"EASY INSTALLATION KIT"

If a dedicated 4 wire, 120/208-240 V, 15 Amp line is not available for this appliance, an optional "Easy Installation Kit" will allow you to connect to a 240 V, 30 Amp line .

This dual receptacle, wall mounted connection box can **ONLY** be used for connecting a Miele clothes washer and a Miele clothes dryer to an existing 30 Amp (NEMA 10-30R) outlet.

For more information on the "Easy Installation Kit," or if you have questions concerning the electrical connection, please contact:

(USA) 1-800-999-1360
techserv@mieleusa.com

(CDN/F) 1-800-565-6435
service@miele.ca

When contacting the Technical Service,
please quote the model and serial number
of your appliance.

The Miele logo is displayed in a bold, white, sans-serif font against a solid black rectangular background.

Miele, Inc. 

National Headquarters

9 Independence Way
Princeton, NJ 08540
Phone: 800-843-7231
609-419-9898
Fax: 609-419-4298
www.mieleusa.com

Technical Service & Support

Nationwide

Phone: 800-999-1360
Fax: 888-586-8056

Miele Limited 

National Headquarters

55G East Beaver Creek Road
Richmond Hill, ON L4B 1E5
Phone: 800-643-5381
905-707-1171
Fax: 905-707-0177
www.miele.ca
info@miele.ca (general enquiries)
professional@miele.ca (commercial enquiries)

Mielecare National Service

Phone: 800-565-6435
905-850-7456
Fax: 905-850-6651
service@miele.ca (Tech. Service)