

Operating and installation instructions for washer-extractor PW 6065

To avoid the risk of accidents or damage to the appliance it is **essential** to read these instructions before it is installed and used for the first time.



M.-Nr. 06 515 620

Caring for the environment

Disposing of the packing material

The transport and protective packing has been selected from materials which are environmentally friendly for disposal and can normally be recycled.

Ensure that any plastic wrappings, bags, etc. are disposed of safely and kept out of the reach of babies and young children. Danger of suffocation.

Rather than just throwing these materials away, please ensure that they are offered for recycling.

Disposal of your old machine

Electrical and electronic machines often contain materials which, if handled or disposed of incorrectly, could be potentially hazardous to human health and to the environment. They are, however, essential for the correct functioning of your machine. Please do not therefore dispose of it with your household waste.

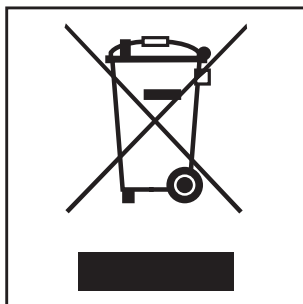

Please dispose of it at your local community waste collection/recycling centre, and ensure that it presents no danger to children while being stored for disposal.

It should be disconnected from the mains supply by a competent person. The cable should be cut off directly behind it to prevent misuse. See the "Warning and Safety" section of this booklet for further details.

Energy saving tips

Energy and water consumption

- Water consumption and energy usage are determined by the size of the load.
To make the most out of your machine load the maximum dry load for the programme you are using.
- If smaller loads are washed using the *Cottons programmes*, the automatic load recognition system will reduce the amount of water, time and energy used.

Detergent

- Do not exceed the amounts of detergent recommended by the manufacturer on the packaging.
- Reduce the amount of detergent for smaller loads.

Caring for the environment	2
Disposing of the packing material	2
Disposal of your old machine	2
Energy saving tips	2
Warning and Safety instructions	6
Operating the washer-extractor	9
Control panel	9
Displays	10
Before using for the first time	12
How to wash correctly	14
Brief instructions	14
Spinning	18
Final spin speed	18
Rinse and interim spin	18
Programme chart	19
Programme sequence	23
Garment care label symbols	25
Changing the programme sequence	26
Altering a programme	26
Cancelling a programme	26
Adding or removing laundry after a programme has started	26
Detergent	27
Water softeners	28
Washing with several components	28

Contents

External dispensing system	28
Fabric conditioners and liquid starch	29
Automatic dispensing of fabric conditioner or liquid starch to laundry at the end of a programme	29
Colour run and dye removers / dyes	29
Cleaning and care	30
Cleaning the water inlet filters	32
Problem solving guide	33
What to do, if	33
The programme does not start	33
General problems	34
An unsatisfactory wash result	35
The drum door cannot be opened by pressing the  button	36
Opening the drum door in the event of a blocked drain outlet and/or power failure	37
Changing the lamp for the drum lighting	40
After sales service	41
PC / Optical interface	41
Optional accessories	41
Installation and connection	42
Front view	42
Rear view	43
Installation on a raised plinth	44
Washer-dryer stack	44
Payment system	44
Installation surface	45
Installing the washer-extractor	45
Removing the transit fittings	45
Re-fitting the transit bars	47
Levelling the machine	48

Contents

Plumbing	49
Connection to the cold water supply	49
Connection to the hot water supply	50
Connection to drainage	51
Machines with a drain pump	51
Drain valve version	51
Electrical connection U.K.	52
Technical data	53
Settings menu ▮	56
To open the Settings menu	56
Language ▮	57
Water plus	57
Suds cooling	57
Time of day	58
Display contrast	58
Display brightness	58
Standby	59
Memory	59
Temperature units	59
Settings/Supervisor level menu	60

Warning and Safety instructions

To avoid the risk of accidents and damage to the machine please read these operating instructions carefully before using it for the first time. They contain important information on its safety, use and maintenance. Keep these instructions in a safe place and ensure that new users are familiar with the content. Pass them on to any future owner of the machine.

Correct use

Only use this washer-extractor to wash items which are specified by the manufacturer to be machine-washable on the wash-care label, and textiles composed of hand-washable wool or wool blend fabrics as well as satin, lace, silk and other hand-washable garments. Any other applications may be dangerous. The manufacturer is not liable for damage resulting from improper use or operation.

Technical safety

Before setting up the machine, check it for any externally visible damage. Do not install or use a damaged machine.

Before connecting the machine, ensure that the connection data on the data plate (voltage and connected load) match the mains electricity supply. If in any doubt, consult a qualified electrician.

The electrical safety of this machine can only be guaranteed when continuity is complete between the machine and an effective earthing system which complies with local and national safety regulations. It is most important that this basic safety requirement is present and regularly tested, and where there is any doubt the on-site wiring system should be inspected by a qualified electrician. The manufacturer cannot be held liable for the consequences of an inadequate earthing system (e.g. electric shock).

Do not connect the machine to the mains electricity supply by an extension lead. Extension leads do not guarantee the required safety of the machine (e.g. danger of overheating).

The machine is built in accordance with current safety requirements. Unauthorised repairs could result in unforeseen dangers for the user, for which the manufacturer cannot accept liability. Repairs should only be undertaken by a Miele approved technician.

Ensure current is not supplied to the machine until after maintenance or repair work has been carried out.

In the even of a fault or for cleaning purposes, the machine is only completely isolated from the electricity supply when:

- it is switched off at the mains, or
- the mains fuse is withdrawn.

Warning and Safety instructions

■ This machine must only be connected to the on-site water supply using a new hose kit. Old hoses must not be re-used. Check the hose regularly for signs of wear. Change in good time to avoid the risk of leaks and subsequent damage.

■ Faulty components must only be replaced by genuine Miele original spare parts. Only when these parts are fitted can the safety standards of the machine be guaranteed.

■ If the connection cable is faulty it must only be replaced by a Miele approved service technician to protect the user from danger.

■ In countries where there are areas which may be subject to infestation by cockroaches or other vermin, pay particular attention to keeping the machine and its surroundings in a clean condition at all times. Any damage which may be caused by cockroaches or other vermin will not be covered by the machine guarantee.

Use

■ This equipment may only be used in mobile installations such as ships, caravans, aircraft etc. if a risk assessment of the installation has been carried out by a suitably qualified engineer.

■ Do not install this machine in rooms where temperatures below freezing may occur. Frozen hoses may burst under pressure. The reliability of the electronic control unit may be impaired at temperatures below freezing point.

■ Before using the machine for the first time, check that the transit fitting at the rear of the machine has been removed (see section on "Installation"). During spinning, a transit fitting which is still in place may result in damage to both the machine and adjacent furniture or appliances.

■ Turn off the stopcock if the machine is to be left for any length of time (e.g. holiday), especially if there is no floor drain (gully) in the immediate vicinity.

■ Flooding danger.

■ If hooking the drain hose of a drain pump machine into a wash basin, check that the water can drain off quickly enough to prevent the sink from overflowing. Make sure the drain hose is secure, so that the force of the water flowing out of the hose does not dislodge it. Otherwise this will result in flooding.

■ Take care to ensure that foreign objects (e.g. nails, pins, coins, paper clips) do not find their way into the machine with the laundry. These may damage components of the machine (e.g. suds container, drum), which in turn can result in damage to the laundry.

Warning and Safety instructions

■ If the correct amount of detergent is dispensed, the machine should not need to be descaled. If, however, you do wish to descale the machine only use proprietary non-corrosive descaling agents and strictly observe the instructions on the packaging. If in doubt contact the Miele Professional Dept. or your Miele Dealer.

■ Textiles which have been pre-treated in solvent based cleaning agents must be thoroughly rinsed in clean water before being washed in the machine.

■ Never use solvent based cleaning agents in this machine, as this may result in damage to component parts and create toxic fumes. Such detergents also pose a fire and explosion hazard.

■ Only use dyes specified by the manufacturer as being suitable for use in a washing machine. Always observe the manufacturer's instructions carefully.

■ Colour run and dye removers contain sulphur compounds which can cause damage such as corrosion. Do not use these products in this machine.

■ Avoid contact of stainless steel surfaces (front, lid, casing) with liquid cleaning and disinfecting agents which contain chlorine or sodium hypochlorite. These agents can have a corrosive effect on stainless steel. Aggressive vapours containing chlorine bleach can also be corrosive. Do not store open containers or these agents near the machine.

Safety with children

■ This machine is not a toy! To avoid the risk of injury do not allow children to play on or near it or to play with the controls. Supervise its use by the elderly or infirm, and supervise children whilst you are operating the machine.

■ For machines with a 'porthole' door, remember that the porthole glass will be hot when washing at very high temperatures. Do not let children touch it.

Accessories

■ Accessory parts may only be fitted when expressly approved by Miele. If other parts are used, guarantee, performance and product liability claims will be invalidated.

Disposal of your old machine

■ Before discarding an old machine disconnect it from the electricity supply. Cut off the cable directly behind the machine to prevent misuse. This should be done by a competent person.

■ The manufacturer cannot be held liable for damage caused by non-compliance with these Warning and Safety instructions.

Operating the washer-extractor

Control panel

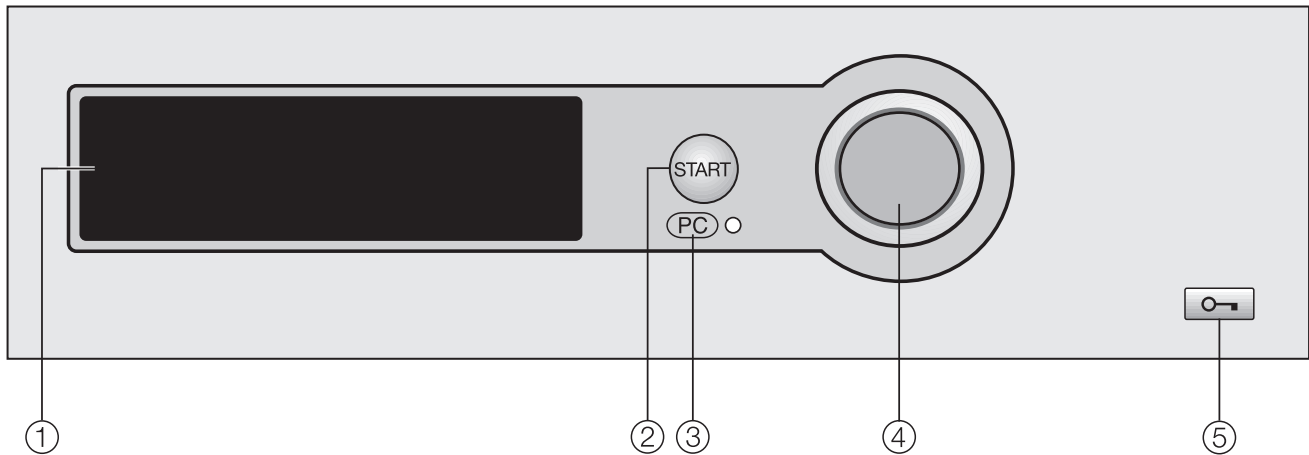

① **Display**

See the following pages for more information.

② **Start button**

③ **PC / Optical interface**

This is used by service technicians to run diagnostic checks on your machine and can also be used to update programming data in the future.

④ **Multi-function selector**

This is used to select menu options (by turning it) and to confirm your selection (by pressing it).

⑤ **Key button**

Opens the machine door.

Operating the washer-extractor

Displays

Entry menu

The machine is on standby if the display remains dark when you switch the machine on. Press the multi-function selector.

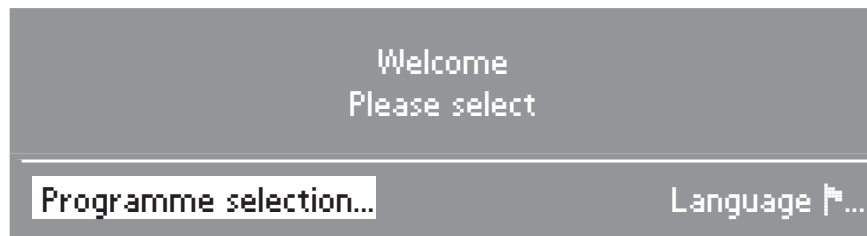

The entry menu will appear with *Programme selection* highlighted. Press the multi-function selector. The Programme selection menu will appear.

Programme selection menu

Cottons Hygiene 95°C	Minimum iron	40°C
Cottons Uni. 60°C	Minimum iron	30°C
Cottons Uni. 40°C	Denim	40°C
Minimum iron 60°C	Delicates	30°C ▼

If you do not make a selection within approx. 20 seconds, the display will revert to the main menu.

Multi-function selector

Turning the multi-function selector moves the highlighting to the next option.

Pressing the multi-function selector selects the highlighted option.

You can use the multi-function selector to select any programme. The highlighting will move up or down depending on the direction the multi-function selector is turned in. The ▼▲ arrows on the right of the display, indicate further options. Pressing the multi-function selector takes you to the main menu of the wash programme selected.

Operating the washer-extractor

Wash programme main menu



The main menu shows the temperature and spin speed for the wash programme selected. The *Pre-wash* extra option is highlighted. Press the multi-function selector to deselect / select *Pre-wash*.

To return to the Programme selection menu turn the multi-function selector to highlight *Back* and then press the multi-function selector to confirm your selection.

Settings menu

The *Settings* menu is used to alter the washing machine's electronics to suit different requirements. See "Settings menu" for more details.

Before using for the first time

Before using the machine for the first time ensure that it is correctly installed and connected. See "Installation and connection". Also check that the drain filter is securely tightened to prevent the risk of water leaks during use.

For safety reasons spinning is not possible until the machine has been prepared for using for the first time. To activate the spinning function you must run a wash programme without laundry and without detergent.

- Open the stopcocks.

Welcome screen

When the washer-extractor is switched on for the first time, a welcome screen will appear.



The welcome screen will not appear again once a programme lasting longer than one hour has been completed.

After four seconds the display will change to the screen for setting the language.

Sprache

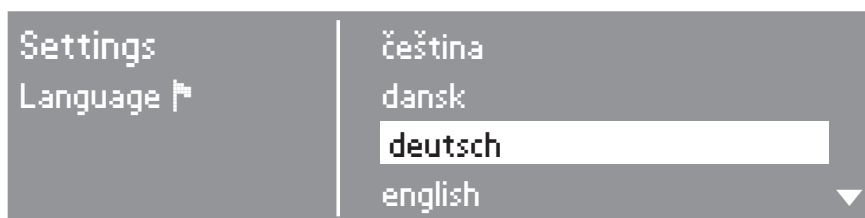

- Select the language you want and confirm your selection.

Setting the time of day

Set the hour with the multi-function selector and confirm this setting. Then set the minutes. Confirm the selection again to save the time of day in memory.

Before using for the first time

Reminder to remove transport struts

The machine will remind you to remove the transport struts.

- Remove the transport struts (if this has not already been done by your fitter). Then press the multi-function selector to confirm that this has been done.

Running your first programme



- Turn the multi-function selector until *Programme selection* is highlighted and then press the multi-function selector to confirm your selection.
- Select *Cottons Uni. 60°C* and confirm your selection.

The main menu for *Cottons Uni.* will appear.



- Press the flashing *Start* button (the machine door must be closed).

When this programme has finished, your machine is ready for using for the first time.

How to wash correctly

Brief instructions

The headings numbered ①, ②, ③, . . . show the operating sequence and can be used as brief instructions.

① Sort the laundry

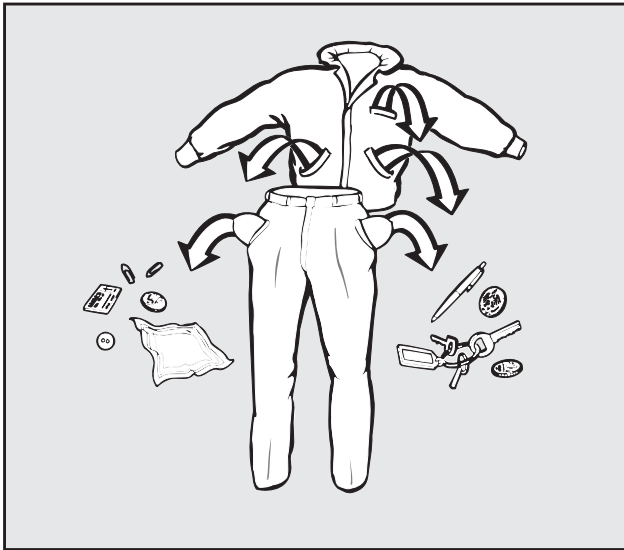

- Empty all pockets.

⚠ Foreign objects (e.g. nails, coins, paper clips, etc.) can cause damage to garments and components in the machine.

Removing marks

- Badly soiled areas, stains etc. should be removed as soon as possible, preferably whilst still fresh. Spillages should be carefully dabbed off using a soft colourfast cloth. Do not rub!

Badly soiled areas can be pre-treated with liquid detergent, stain removers etc. first, following the manufacturer's instructions. With particularly stubborn stains ask your dry cleaner for advice.

⚠ Do not use solvent-based cleaning agents in this machine.

- Sort the laundry by colour and by care label. Most garments have a textile care label in the collar or side seam.

Dark textiles often contain excess dye and should be washed separately several times before being included in a mixed load. Always wash whites and coloureds separately.

- Curtains: Remove lead weights first or place in a laundry bag.
- Underwiring and collar stiffeners: Any loose wiring in bras, shirt collar stiffeners, etc. should be removed or sewn in.
- Knitted garments, trousers and jeans, T-shirts and sweat shirts: Turn inside out, if recommended by the manufacturer.
- Close any zips, fasten hooks and eyes etc before washing.
- Fasten duvet covers etc. to prevent small items from being rolled up inside them.

Do not wash any items in this machine which are specified by the manufacturer as **not washable** on the care label (☒ symbol).

How to wash correctly

② Load the drum

- Press the  button and open the drum door.

The interior drum lighting will come on.

- Unfold the laundry and load loosely in the drum. Mixing both large and small items gives better wash results and also helps distribute the load evenly during spinning.

The most efficient use of energy and water is achieved when a full load is washed. However, do not overload as this causes creases and reduces cleaning efficiency.

- Shut the door with a gentle swing.

Make sure that no garments are caught between the drum door and seal.

③ Select a language

- Select the language you want.

④ Select a programme

Select a programme from the *Programme selection* menu.

- If *Pre-wash* is available for the programme, select it if wished.

Payment system

If your machine has a payment system, the amount of credit required will appear in the display.

Credit will be lost if the door is opened or the programme cancelled after it has started.

How to wash correctly

5 Add detergent

Take the level of soiling and water hardness into account. It is important to dispense the correct amount, because

too little detergent results in:

- Laundry not getting properly clean and with time it may become grey and hard to the touch.
- Greasy particles clinging to the laundry.
- Limescale deposits on the heater elements.

too much detergent results in:

- Excessive foam which causes a low level of agitation and poor wash, rinse and spin results.
- A burden to the environment.

See "Detergent" for further information.

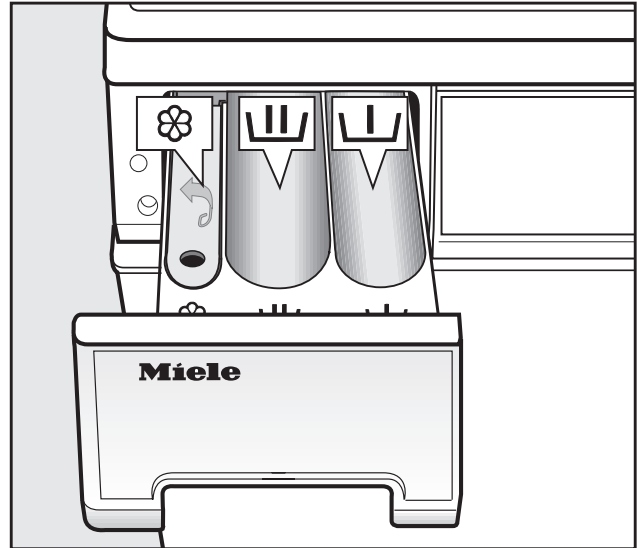

- Pull out the detergent drawer and add detergent to the compartments as follows:

 = Detergent for the pre-wash ($\frac{1}{4}$ of the total amount recommended). This compartment is also used for starch formulations when starching separately.

 = Detergent for the main wash

 = Fabric conditioner or liquid starch

- Close the detergent drawer.

How to wash correctly

6 Start the programme

The *Start* button will flash as soon as a programme can be started.

- Press the *Start* button.

The *Start* button will light up.

The estimated programme duration will appear in the display. This will count down in one minute steps. During the first 10 minutes the machine measures how much water is being absorbed by the laundry. The programme duration may be shorter depending on this absorbency rate.

The programme sequence is also shown in the display. The washer-extractor shows you when each section of the programme is reached.

The drum lighting switches off once the programme has started.

7 Remove the laundry

Only remove laundry from the machine once the drum has stopped turning. Reaching into a moving drum is extremely dangerous and could result in injury.

If laundry is not removed immediately the programme has finished, the anti-crease phase will begin and the drum will turn at intervals to help prevent creasing.

Anti-crease will flash alternately with *Finish* in the display to indicate that the programme has finished.

- Press the  button to open the drum door.
- Remove the laundry.

Check that all items have been removed from the drum. Items left in the drum could discolour other items in the next wash or become discoloured themselves.

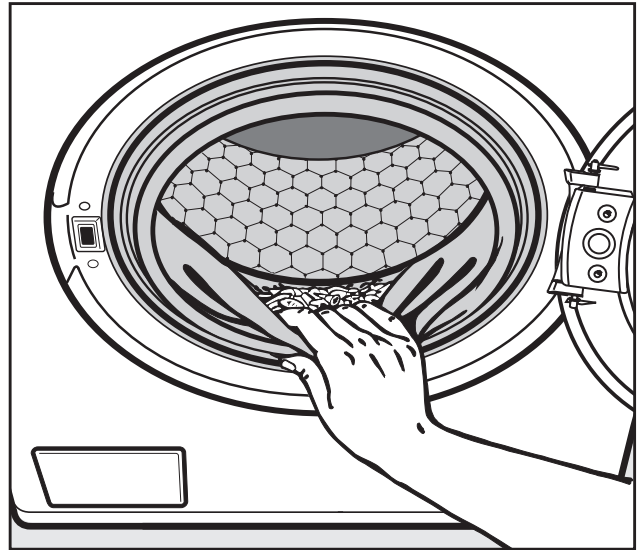

- Check the folds in the door seal for any small articles, e.g. buttons which might be lodged there.
- Close the drum door. Otherwise there is the danger of objects being placed inadvertently in the drum. If these remained unnoticed and were washed in the next load, they could damage the laundry.

Spinning

Final spin speed

The maximum final spin speed is determined by the individual programme and cannot be changed. See chart.



Programme	rpm
Cottons Hygiene	1400
Cottons Uni.	1400
Minimum iron	1000
Denim	900
Delicates	600
Woollens	1200
Kitchen linen*	1400
Table linen*	1200
Curtains*	400
Pillows*	1400
Outerwear*	900
Proofing*	800
Spin	1400

* = These programmes can be selected from the *Settings/Supervisor level* menu, if this has been activated by a Miele service technician or authorised dealer.



Rinse and interim spin

There is a spin after the main wash and between the rinses. You cannot alter this spin speed either.

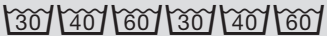
Programme chart

Cottons Hygiene 95°C 	
Fabric type	Cottons, linens or cotton mix fabrics.
Detergent	Powder detergent, detergent for coloured fabrics, liquid detergent, tablet detergent and liquid tab detergent.
Max. load	6.5 kg
Cottons Uni. 40°C, 60°C 	
Fabric type	Cottons or cotton mix fabrics, e.g. T-shirts, trousers.
Note	– For dark coloured fabrics use a detergent for coloured fabrics, or liquid detergent.
Detergent	Powder detergent, detergent for coloured fabrics, liquid detergent, tablet detergent and liquid tab detergent.
Max. load	6.5 kg
Minimum iron 30°C, 40°C, 60°C 	
Fabric type	Synthetics, mixed fibres and easy care cottons.
Detergent	Powder detergent, detergent for coloured fabrics, liquid detergent, detergent for delicates, tablet detergent and liquid tab detergent.
Max. load	3.5 kg
Denim 40°C	
Note	– Wash denim inside out. – Denim often contains excess dye and will run during the first few washes. Wash light and dark coloured items separately.
Detergent	Liquid detergent for coloured fabrics.
Max. load	3.5 kg

Programme chart

Delicates 30°C 	
Fabric type	For delicate garments made of synthetic fibres, mixed fibres, rayon and easy care cottons.
Detergent	Liquid detergent for delicates.
Max. load	2.5 kg
Woollens  30°C 	
Fabric type	Machine-washable or hand-washable wool or wool blend fabrics.
Detergent	Liquid detergent for machine-washable woollens.
Max. load	2.5 kg
Drain	
For draining water from the machine.	
Spin	
For spinning garments. Please make sure you select the appropriate spin speed.	
Max. load	6.5 kg

Further programmes

The following programmes can be selected from the *Settings/Supervisor level* menu, if they have been activated by a Miele service technician.

Kitchen linen 60°C

Item	Kitchen linen made from cotton and linen fabrics, e.g. chef's whites, catering uniforms, serving cloths, floor cloths.
Note	Select <i>Pre-wash</i> for stubborn soiling. Use a detergent containing enzymes for the pre-wash.
Detergent	Powder detergent, detergent for coloured fabrics, liquid detergent, tablet detergent and liquid tab detergent.
Max. load	3.5 kg

Table linen 40°C

Item	Cotton, linen and mixed fibre table linen, such as tablecloths and napkins.
Notes	Use a detergent containing enzymes for stubborn soiling.
Detergent	Powder detergent, detergent for coloured fabrics, liquid detergent, tablet detergent and liquid tab detergent.
Max. load	6.5 kg

























Curtains 30°C



Item	Curtains, including net curtains, specified as machine-washable by the manufacturer. A pre-rinse without detergent is carried out automatically to remove dust.
Detergent	All purpose powder detergent, powder detergent for coloured fabrics.
Max. load	3.0 kg

Programme chart

Pillows 60°C	
Item	Washable pillows with feather, down or synthetic fillings.
Note	Please observe the instructions on the wash care label.
Detergent	Liquid detergent
Max. load	2 pillows (40 x 80 cm) or 1 pillow (80 x 80 cm)
Outerwear 40°C	
Item	Outerwear made from micro-fibres such as Gore-Tex [®] , Sympatex [®] , Windstopper [®] etc.
Notes	<ul style="list-style-type: none"> – Zip up jackets before washing. – Do not use fabric conditioner.
Detergent	Specialist detergent.
Max. load	3.5 kg
Proofing 30°C	
Item	For treating microfibre fabrics, ski wear, fine, closeweave cotton garments (poplin) or tablecloths to provide a water and dirt resistant finish.
Notes	<ul style="list-style-type: none"> – The items should be freshly washed and spun or dried before proofing. – For best results, the items should be heat-treated afterwards, either in a tumble dryer or by ironing.
Proofing agent	<ul style="list-style-type: none"> – Only use proofing agents which are stated by the manufacturer as being "suitable for use on membrane textiles" as these consist of fluorochemical compounds. Do not use proofing agents which contain paraffin. – Place the container for liquid detergent in compartment  and add proofing agent.
Max. load	3.5 kg

Programme sequence

	Main wash		Rinses		Spinning	
	Water level	Wash rhythm	Water level	Rinses	Spinning	Final spin
Cottons Hygiene		Ⓐ		2	✓	✓
Cottons Uni.		Ⓐ		2	✓	✓
Minimum iron		Ⓐ		2	✓	✓
Denim		Ⓐ		3	–	✓
Delicates		Ⓑ		2	–	✓
Woollens 		Ⓒ		2	✓	✓
Kitchen linen*		Ⓐ		2	✓	✓
Table linen*		Ⓐ		2	✓	✓
Pillows ¹⁾ *		Ⓐ		3	–	✓
Curtains ²⁾ *		Ⓐ		3	–	✓
Outerwear*		Ⓑ		3	✓ ³⁾	✓
Proofing*	–	–		1	✓	✓

 = Low water level Ⓐ = Normal wash rhythm
 = Medium water level Ⓑ = Gentle action
 = High water level Ⓒ = Woollens

See the following page for more information about the programme sequences.

* = These programmes can be selected from the *Settings/Supervisor level* menu, if this has been activated by a Miele service technician or authorised dealer.

Programme sequence

This machine has fully electronic controls with automatic load recognition. It takes in the right amount of water required for the programme depending on the amount of laundry and its absorbency rate. This means that programme cycles and durations can vary.

The programme sequences outlined in the chart are based on the basic programme with a full load. Extra options which can be selected have not been taken into account.

The programme sequence display shows the stage the programme has reached.







Special features in the programme sequences:

Anti-crease:



At the end of every programme, with the exception of the *Wollens* programme, the drum continues to turn at intervals for up to 30 minutes to help prevent creasing. The door can be opened and laundry removed at any time during the anti-crease phase.

- 1) Run-up to spin: A run-up to spin is carried out before the wash process begins to deflate air from the pillows. Subsequent water intake for the main wash is through compartment .
- 2) Pre-rinse: A Pre-rinse without detergent is carried out automatically to remove dust.
- 3) In the *Outerwear* programme, laundry is only spun after the main wash.





Garment care label symbols

	Hand wash (If no temperature is specified use the lowest temperature or cold)
	Do not wash
	Dry clean
	Do not dry clean
	Suitable for chlorine bleaching
	Do not use chlorine bleach

Tumble dry

	At normal temperature
	At low temperature
	Do not tumble dry

Ironing

	Hot iron
	Medium hot iron
	Cool iron
	Do not iron

Changing the programme sequence

Altering a programme

After the start of a programme it is no longer possible to select a different programme. You will need to cancel the current programme before you can select a new one.

Cancelling a programme

You can cancel a programme at any time after it has started. Turn the multi-function selector until *Cancel* is highlighted and then press the multi-function selector to confirm your selection.

The suds will be pumped away.

- Open the drum door before starting a new programme.

If your machine is fitted with a payment system, it will lock after three minutes and it is then no longer possible to cancel the programme.

Adding or removing laundry after a programme has started

In some programmes you can add or remove laundry up to three minutes after the start of the programme.

- Press the door button  to open the drum door.
- Add or remove items.
- Close the drum door.

The programme will continue automatically.

Please note:

Once a programme has started the machine cannot recognise any adjustment to the load.

For this reason, if laundry is added or removed after the start of a programme, the machine will always complete the programme cycle assuming a full load which can lead to an increase in the programme duration shown in the display.

The door cannot be opened, if:

- the suds temperature is above **55°C**.
- the water is above a certain level.
- the programme has reached the *Final spin* stage.



The machine locks after three minutes. It is then no longer possible to open the door.

All modern detergents produced for automatic washing machines are suitable, including liquid, compact (concentrated), tablets and special application detergents. Use dispensing aids, e.g. balls, if these are supplied with the detergent. Tablets are suitable for full loads but note that it may be impractical to reduce tablets by proportion to suit smaller loads. Some tablets do not dissolve as rapidly as others and may not be suitable for programmes with short durations.

Woollens and knitwear containing wool mixtures and hand-washable garments should be washed using a detergent specifically designed for washing woollens.

Instructions for use and recommended amounts for a full load are given on the detergent packaging.

Liquid detergent should be dispensed using a ball provided by the manufacturer for programmes without a pre-wash.

When using liquid detergent for programmes with a pre-wash you will need to purchase a special container from the Miele Spare Parts Department which sits in the main wash compartment  of the detergent dispenser drawer. Add liquid detergent to this container for the main wash and to compartment  for the pre-wash.

The right amount to dispense will depend on the following:

- The soiling level of the laundry
 - Lightly soiled No visible dirt or stains. Possibly slight body odour.
 - Normally soiled Visibly dirty and/or just a few slight stains.
 - Heavily soiled Stains and soiling clearly visible.
- The water hardness level. Check with your local water supplier if you do not know the hardness level in your area.
- The quantity of the laundry (add the recommended amount of detergent).

Detergent

Water softeners

A water softener can be used to cut down on the use of detergents in hard water areas. Dispense according to the amount specified on the packaging. First add detergent and then the water softener.

Use a quantity of detergent as for soft water.

Miele do not recommend connecting the machine to an on-site water softener.

Washing with several components

If you wash using several components (e.g. special application detergents), we recommend always dispensing the agents into compartment  in the following order:

1. Detergent
2. Water softeners
3. Stain remover

This way the agents are distributed more evenly.

External dispensing system

This machine is suitable for connecting to an external dispensing system. A conversion kit is required which must be fitted by a Miele approved service technician.

Fabric conditioners and liquid starch

Fabric conditioners make garments soft to handle and help prevent static cling when tumble drying.

Starch stiffens and gives body to items of laundry, e.g. shirts, tablecloths and bed linen.

- Dispense according to the amount specified on the packaging.

Automatic dispensing of fabric conditioner or liquid starch to laundry at the end of a programme

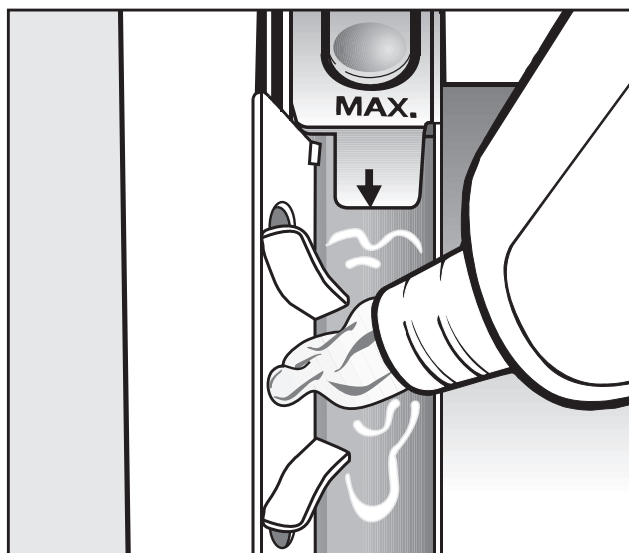

- Add the fabric conditioner or liquid starch to compartment ☼. **Do not exceed the maximum level mark.**

It will be automatically dispensed in the last rinse. At the end of the programme a small amount of water remains in the fabric conditioner compartment ☼.

If starching frequently, clean the dispenser compartment and especially the siphon tube and conditioner channel regularly. See "Cleaning the detergent dispenser drawer".

Colour run and dye removers / dyes

- Do not use colour run or dye removers in this machine.
- Dyes suitable for use in a washing machine can be used. However, please note that the salt used in the dyeing process can cause corrosion to stainless steel components in the machine if you dye frequently. Always observe the manufacturer's instructions carefully.

External dispensing system

This machine is suitable for connecting to an external dispensing system. A conversion kit is required which must be fitted by a Miele approved service technician.

Cleaning and care

 Disconnect the machine from the mains electricity supply.

- Clean the casing with a mild non-abrasive detergent or soap and water. Wipe dry with a soft cloth.
- Clean the fascia panel with a damp cloth and wipe dry with a soft cloth.
- The drum and any other stainless steel components can be cleaned using a suitable proprietary stainless-steel cleaning agent following the manufacturer's instructions on the packaging.

E-Cloth

A microfibre "E-Cloth" is available from the Miele UK Spare Parts Department which is suitable for cleaning surfaces such as stainless steel, glass, plastic and chrome without the use of chemicals.

Extra cleaning

Carry out a hot wash (70°C or above) with powder detergent approx. every 6 weeks to help prevent deposits building up in the machine. These can occur when washing is mainly done at low temperatures and also lead to unpleasant smells.

 Do not use solvents, abrasive cleaners, glass cleaners or all-purpose cleaning agents. These might damage plastic surfaces and other components because of the chemicals they contain.

Cleaning the detergent dispenser drawer

Remove detergent residues regularly.

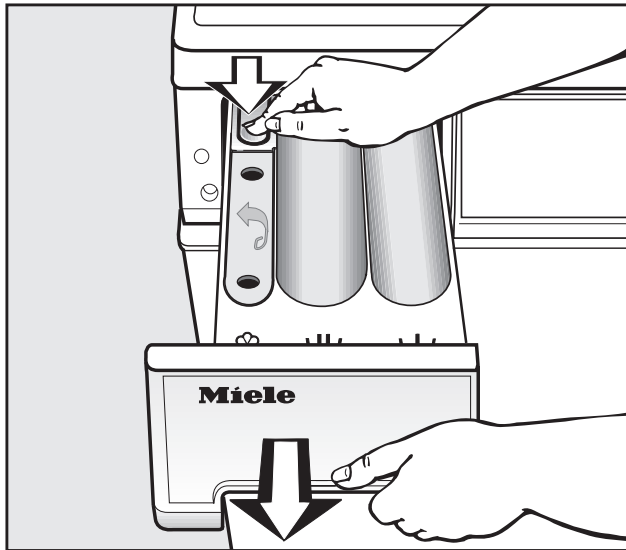

- Pull out the detergent dispenser drawer until a resistance is felt. Press down the release catch and at the same time pull the drawer right out of the machine.
- Clean the detergent drawer with warm water.

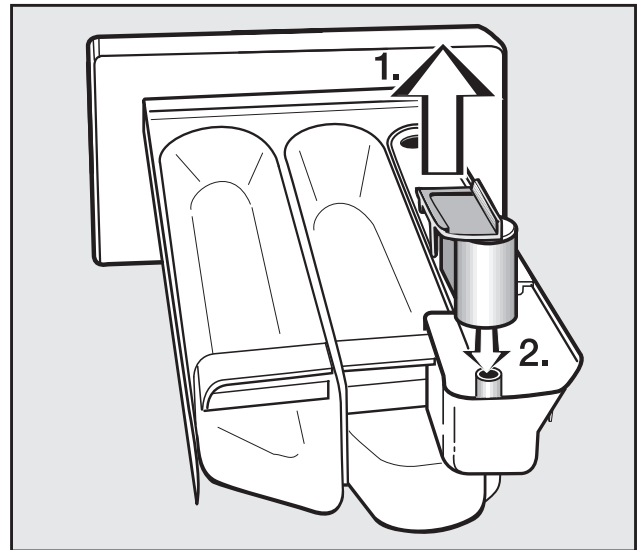

- Clean the siphon.
1. Remove the siphon from compartment ⌘ and rinse under warm running water. Clean the siphon tube in the same way.
 2. Replace the siphon.

 Do not use a hose to wash the machine down.

Cleaning and care

Cleaning the water inlet filters

The machine has two filters to protect the water inlet valve. These filters should be checked every six months or so, or more often if there are frequent interruptions to the external water supply.

To clean the filter in the inlet hose:

- First turn off the stopcock.
- Unscrew the threaded union connecting the free end of the inlet hose to the stopcock.

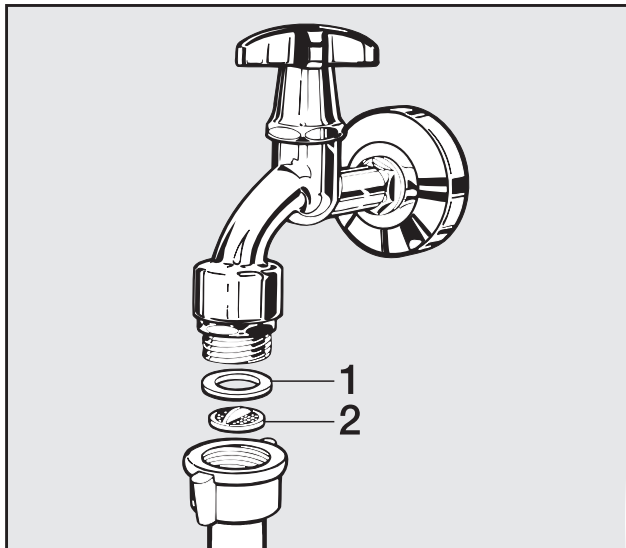

- Remove the rubber seal **1** from the recess.
- Using pointed pliers, take hold of the plastic filter bar **2** and remove.
- Clean the plastic filter.
- Put the filter and seal back in the reverse order and reconnect the hose.

Turn on the stopcock and check the connection is watertight. If water drips out, tighten the connection.

To clean the filter in the water inlet valve:

- Using pliers, carefully loosen the ribbed plastic nut on the inlet valve and unscrew.

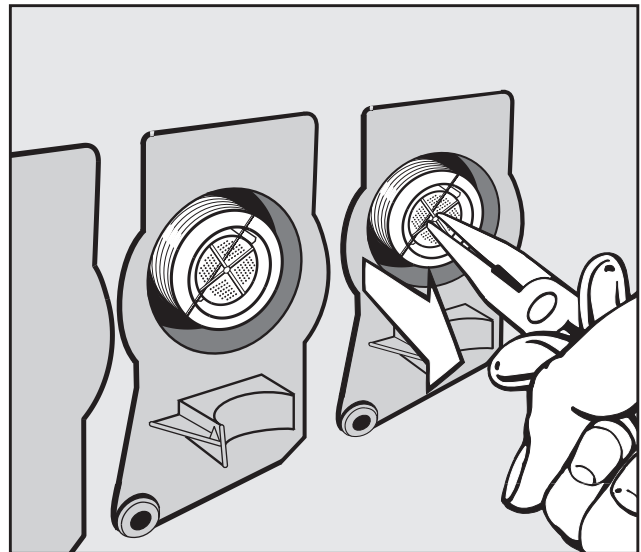

- Use pointed nose pliers to withdraw the plastic filter by the bar (see illustration). Clean, put back and secure.

The two filters **must** be put back in place after cleaning.

What to do, if . . .

With the help of the following notes, minor faults in the performance of the machine, some of which may result from incorrect operation, can be put right without contacting the Service Department.

 Repair work to electrical appliances should only be carried out by a suitably qualified person in accordance with local and national safety regulations. Repairs and other work by unqualified persons could be dangerous. The manufacturer cannot be held liable for unauthorised work.



The programme does not start		
Problem	Possible cause	Remedy
The display remains dark.	There is no power to the machine.	Check whether <ul style="list-style-type: none"> – the electricity supply to the machine is switched on. – the fuse or circuit breaker has tripped.
There is a fault message in the display.	A programme cannot be started while there is a fault message in the display.	<ul style="list-style-type: none"> – Note what is shown in the display. – Press the multi-function selector (which will confirm the message). The fault message will be deleted.
The display is dark and the <i>Start</i> button is flashing slowly.	The display has switched off automatically to save energy (Standby mode).	Press the multi-fuction selector. Standby comes to an end.

Problem solving guide

General problems		
Problem	Possible cause	Remedy
The machine shakes during the spin cycle.	The machine feet are not level.	Level the machine (see "Installation").
The pump makes strange noises.	This is not a fault! These noises occur at the end of a pump sequence as a normal part of the operation.	
Large amounts of detergent residue remain in the detergent dispenser drawer.	The water supply pressure is too low.	Clean the filter in the water inlet.
	Powder detergent used in conjunction with water softeners tends to become sticky.	In future, add washing powder into the dispenser drawer first, and then add the water softener.
Fabric conditioner is not completely dispensed or too much water remains in the ☼ compartment.	The siphon tube is not correctly positioned or is clogged up.	Clean the siphon, (see "Cleaning and care - Cleaning the detergent dispenser drawer").
The display is in a different language.	A different language has been selected in "Settings 🚩" "Language 🚩".	Set the language you want. The flag symbol will guide you.

An unsatisfactory wash result		
Problem	Possible cause	Remedy
Liquid detergent does not give the required result.	Liquid detergents usually contain no bleaching agents. They do not remove fruit, coffee and tea stains.	<ul style="list-style-type: none"> – Use a general purpose detergent containing a bleaching agent. – Pour stain removers into compartment III of the dispenser drawer and liquid detergent into a dispenser ball. – Never put stain removers and liquid detergent together in the dispenser drawer.
Grey, greasy particles cling to washed laundry.	Insufficient amounts of detergent were used to break down the particles of grease in heavily soiled laundry.	<ul style="list-style-type: none"> – Use more detergent. – Before washing the next load run a Cottons 95°C programme with powder detergent but without a load.
White residues which look like powder detergent are seen on dark textiles after washing.	The detergent contained compounds (zeolites) to aid water softening which are not soluble in water. They have ended up on the laundry.	<ul style="list-style-type: none"> – Try and brush off the residues with a soft brush once the laundry is dry. – Wash dark textiles using a detergent which contains no zeolites. Liquid detergents usually contain no zeolites.
Textiles have particularly greasy soiling.	<ul style="list-style-type: none"> – Select a programme with pre-wash. <p>The use of heavy-duty detergent is recommended in the main wash for very heavily soiled work clothing. Consult detergent producers for advice.</p>	

Problem solving guide

The drum door cannot be opened by pressing the  button	
Possible cause	Remedy
There is no power to the machine.	Check whether <ul style="list-style-type: none">– the electricity supply to the machine is switched on.– the fuse or circuit breaker has tripped.
Power cut.	Open the drum door as described in the next section.
The door was not correctly engaged.	Press hard against the lock side of the drum door and then press the  button.
There is still water in the drum and the machine is unable to drain.	The drainage system may be blocked. Clean the drainage system as described in the next section.
For safety reasons the drum door cannot be opened if the suds temperature is higher than 55°C.	

Opening the drum door in the event of a blocked drain outlet and/or power failure

 Disconnect the machine from the mains electricity supply.

There is a lever behind the detergent drawer fascia panel.

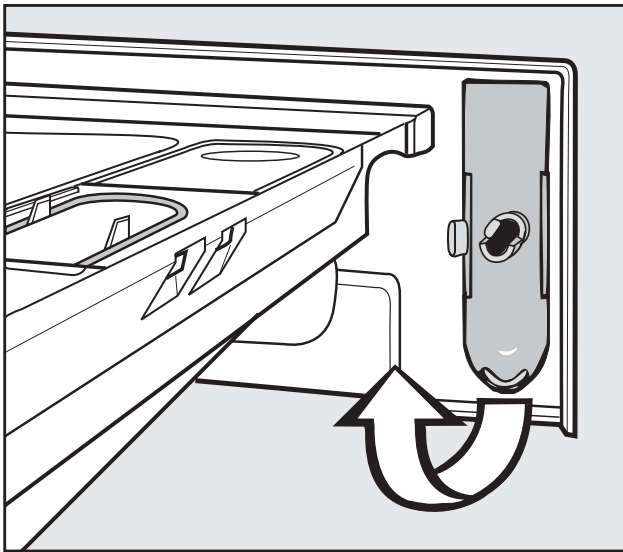

- Remove the lever.

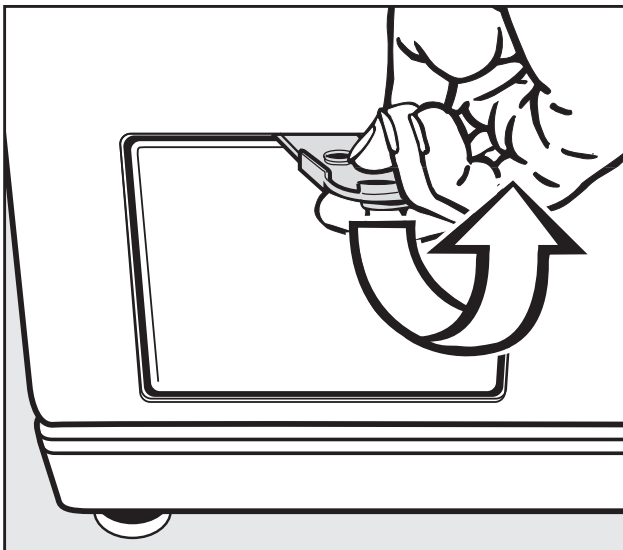

- Use it to open the access flap.

... Machines with a drain pump

If the drain outlet is clogged, a large amount of water will be retained in the machine (**up to 30 litres**).

 Caution: if laundry has been washed at a high temperature, water draining out of the machine will still be hot. Danger of scalding!

- Place a suitable container under the access flap.

When draining water from the machine, do **not** unscrew the drain filter completely or take it right out.

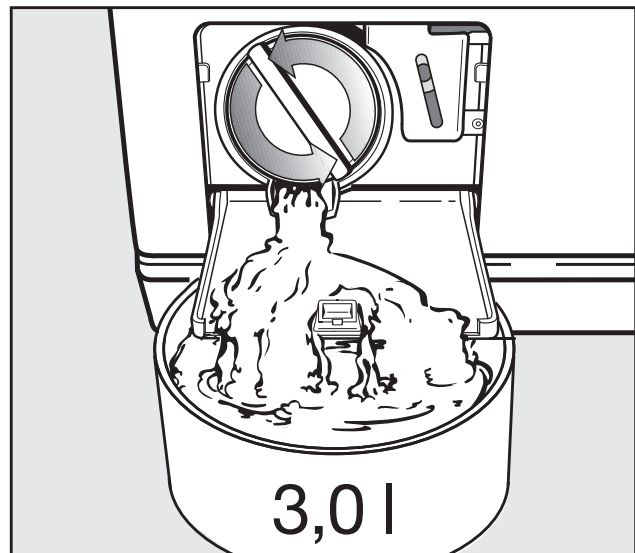

- Unscrew the drain filter lid until water runs out.

To interrupt the flow of water:

- Tighten the drain filter back up again.

Problem solving guide

Once the flow of water ceases:

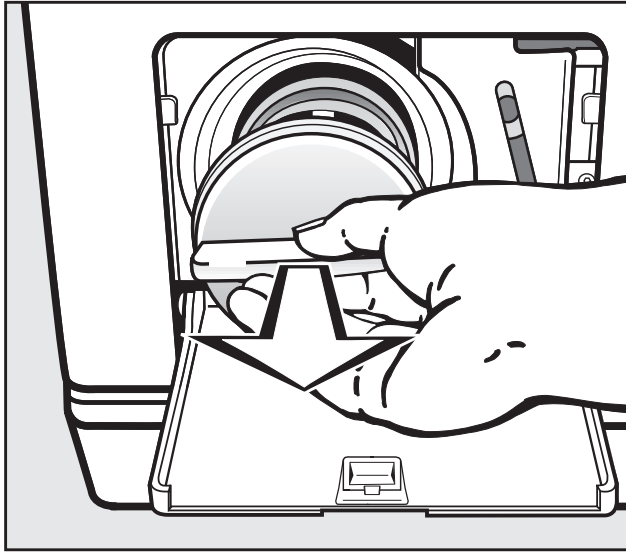

- Remove the drain filter completely.
- Clean it thoroughly.

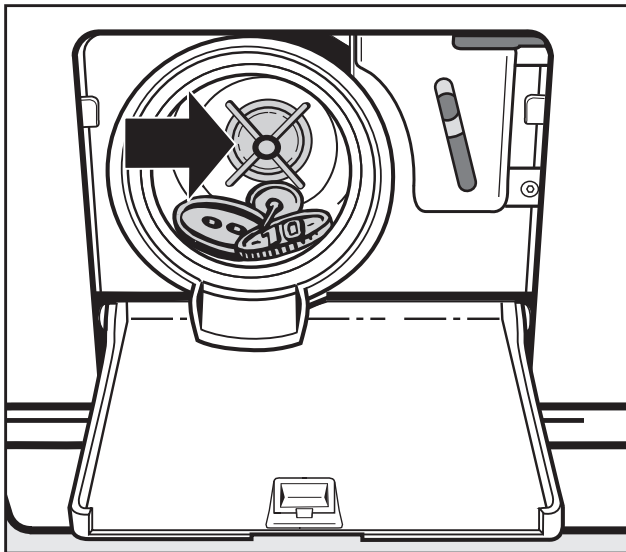

- Remove any foreign objects (e.g. buttons, coins, etc.) and fluff from the filter housing. Turn the impeller by hand to check that it rotates freely.
- Put the drain filter back in place and secure.

⚠ Make sure the drain filter is securely tightened. Otherwise there is a risk of water leakage during use.

Opening the drum door

⚠ Always make sure that the drum is stationary before reaching into the machine to remove laundry. Reaching into a moving drum is extremely dangerous.

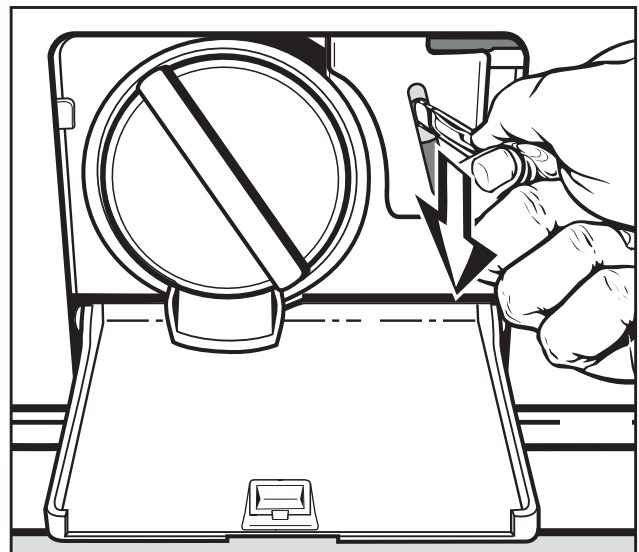

- Use a spoon handle to pull the emergency release downwards (see arrow). The drum door will open.

... Machines with a drain valve

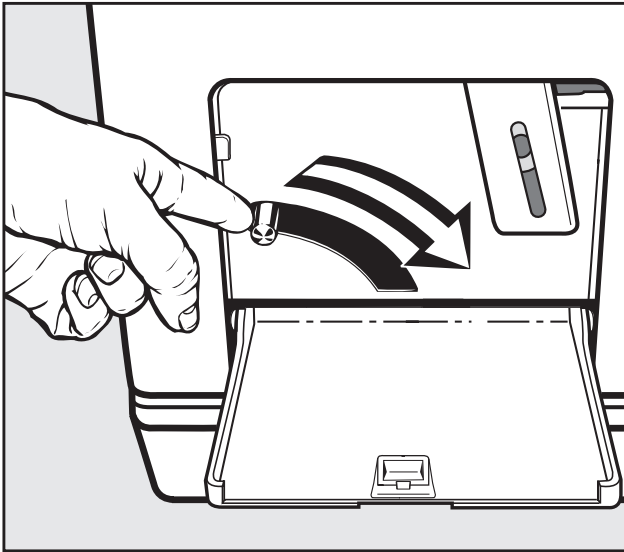

- Push the emergency drain lever downwards (see illustration) and hold until no more water runs out.

Opening the drum door

⚠ Always make sure that the drum is stationary before reaching into the machine to remove laundry. Reaching into a moving drum is extremely dangerous.

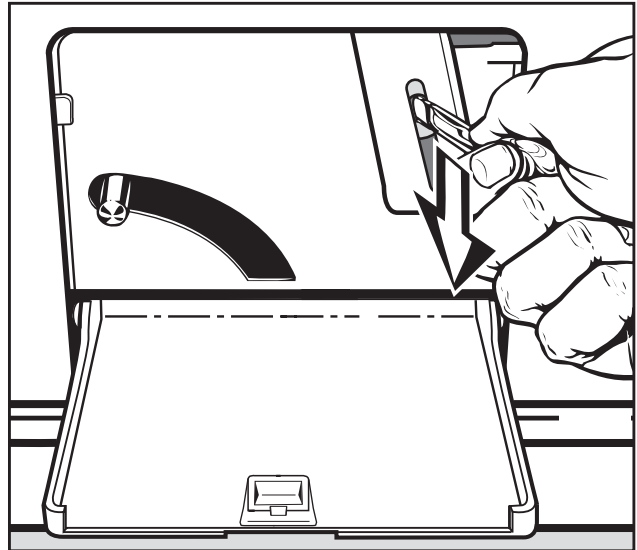

- Use a spoon handle to pull the emergency release downwards (see arrow). The drum door will open.

Problem solving guide

Changing the lamp for the drum lighting

The machine will operate with no lighting in place or if the lighting is faulty.

- Open the drum door.
- Now disconnect the machine from the electricity supply, see "Warning and Safety instructions".
- Remove the yellow lever from behind the detergent drawer fascia panel.

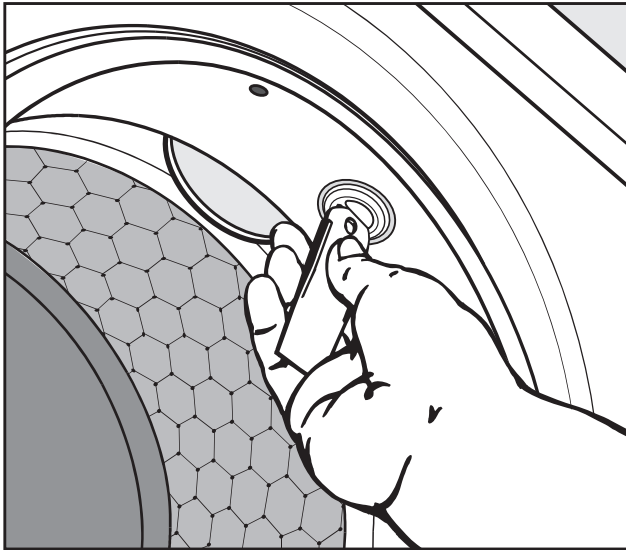

- Insert the lever in the slot provided in the drum lighting unit (see illustration) and turn anti-clockwise (a quarter turn) until you feel a resistance.
- Pull out the loosened unit with your fingers.

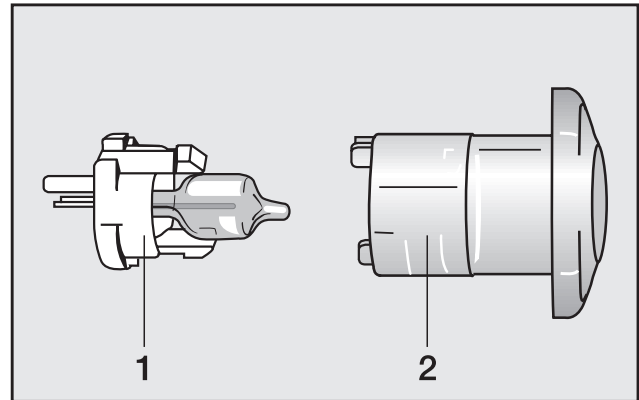

- Press the two prongs to separate the plastic holder **1** from the protective cover **2**.
- Remove the faulty lamp from the plastic holder.

The new lamp must be of the same type (G4) with a maximum power output of 5 watts/12 volts.

The lamps are available from an electrical retailer, your Miele Dealer or from the Miele Spare Parts Department.

- Insert the new lamp into the plastic holder.
- Carefully fit the plastic holder and the protective cover together.
- Insert the lighting unit into the socket and turn it clockwise to secure it.

It is absolutely essential for the correct functioning of the washer-extractor that the drum lighting unit is fitted correctly in position.

In the event of any faults which you cannot remedy yourself, please contact:

- your Miele dealer, or
- the Miele Service Department (see back cover for contact details).

When contacting your Dealer or the Service Department, please quote the model and serial number of your machine, both of which are shown on the data plate visible above the porthole glass when the drum door is open.

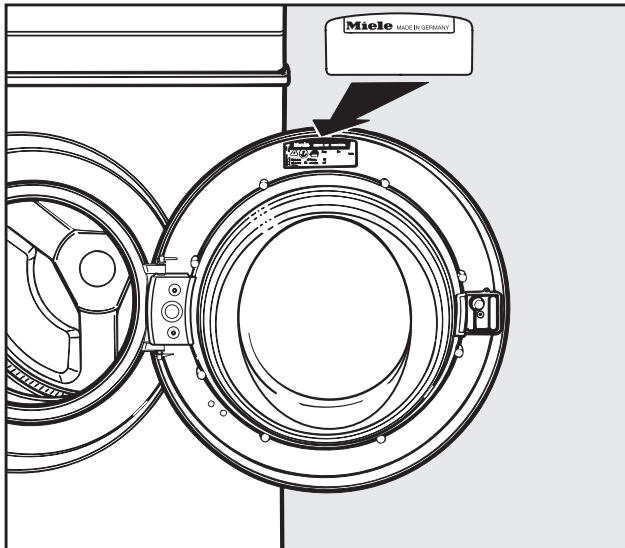

PC / Optical interface

The indicator or check light marked **PC** on the fascia panel is the interface used by Miele service technicians during servicing work for testing purposes and for updating the machine's programme data.

Optional accessories

Optional accessories for this washer-extractor are available from your Miele Dealer or from the Miele Spare Parts Department.

Please note that telephone calls may be monitored and recorded for training purposes.

Installation and connection

Front view

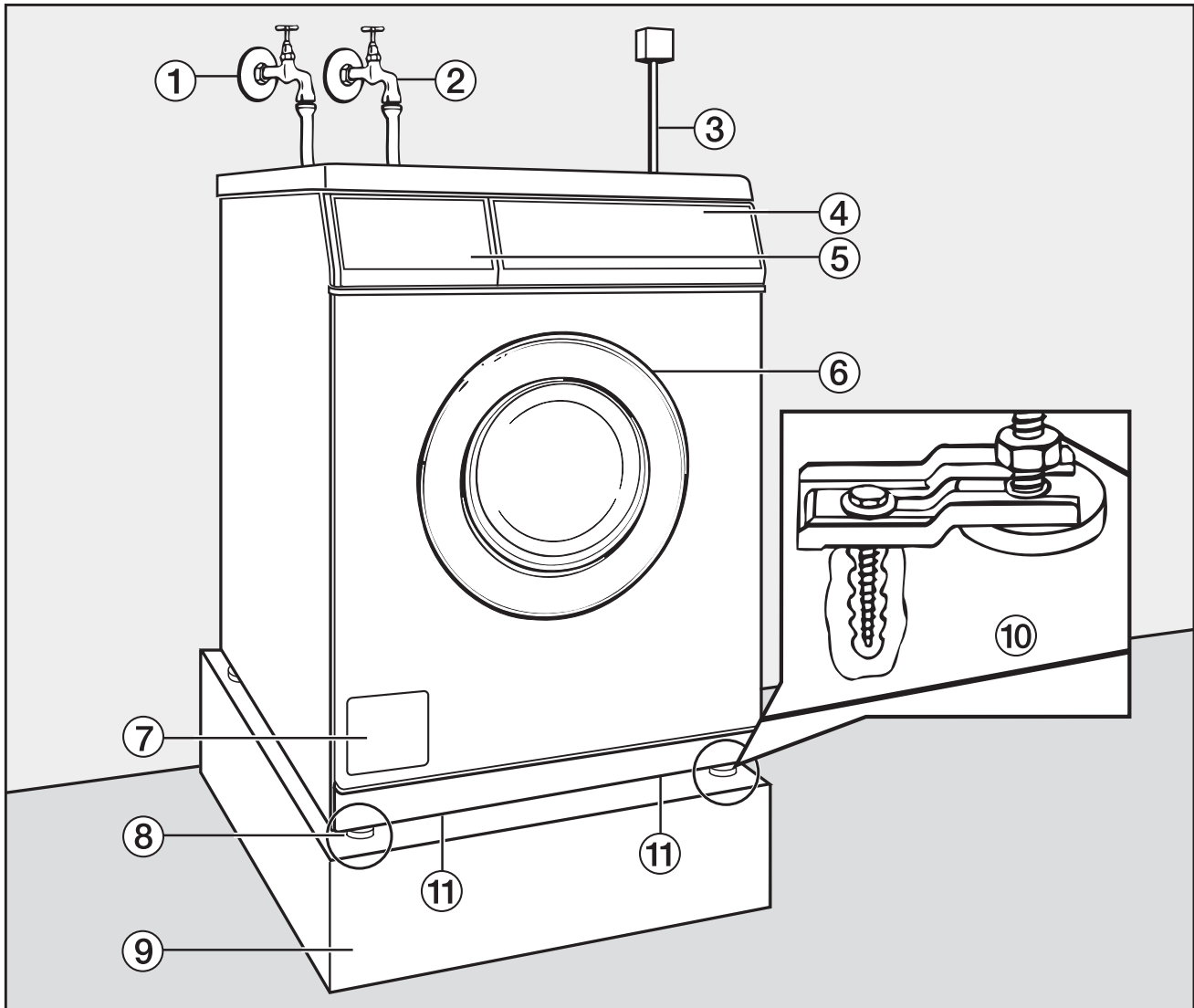

① Inlet hose (cold water)

② Inlet hose (hot water)

③ Mains connection cable

④ Control panel

⑤ Detergent dispenser drawer

⑥ Drum door

⑦ Access to drain filter, drain pump or drain valve and emergency release

⑧ Height adjustable feet

⑨ Plinth

⑩ Clamps (for installing on a concrete plinth)

⑪ Handle recesses for moving the machine

Rear view

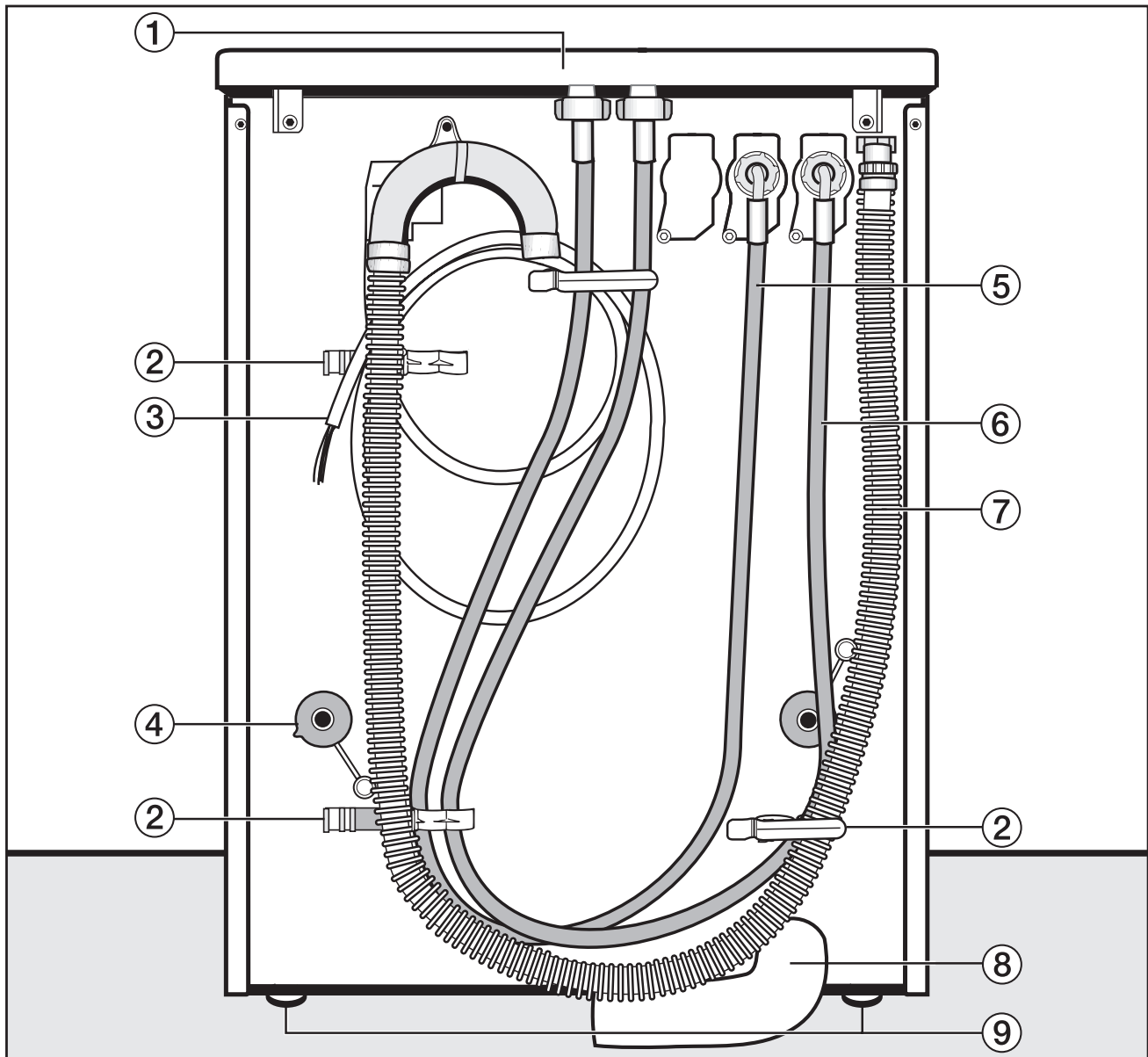

- ① Protruding lid for holding when moving the machine
- ② Holder for:
 - Inlet hose
 - Drain hose
 - Transit bars when removed
- ③ Mains connection cable
- ④ Transit bar covers
- ⑤ Inlet hose (cold water)
- ⑥ Inlet hose (hot water)
- ⑦ Drain hose (for drain pump)
- ⑧ Drain hose (for drain valve)
- ⑨ Height adjustable feet

Installation and connection

The washer-extractor is not suitable for building under.

Installation on a raised plinth

The machine can be installed on a steel plinth base (available open or closed) or on a concrete plinth.

- Secure the front feet of the washer-extractor with the clamps supplied when installing on a concrete plinth.
- Follow the fitting instructions supplied.

Washer-dryer stack

A Miele tumble dryer can be stacked on top of this washer-extractor. The appropriate stacking kit* (WTV) is required.

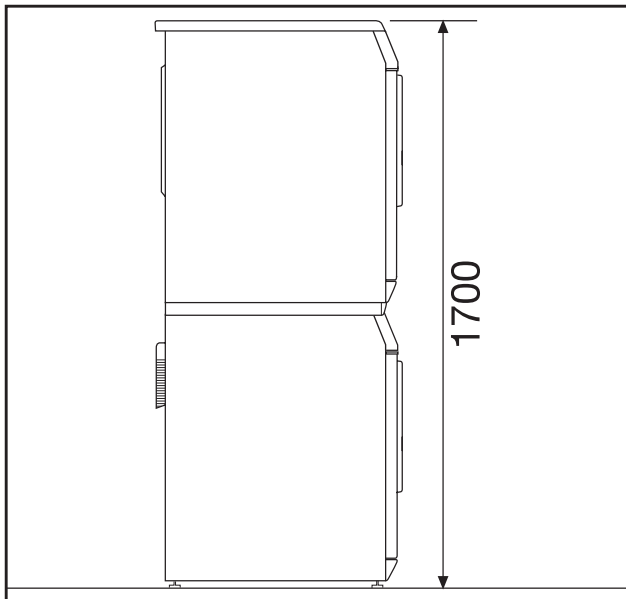

The stacking kit must be fitted by a Miele authorised service technician.

Replacing the lid

If the lid has been removed in order to fit the washer-dryer stack, ensure that, if the lid is ever replaced, it fits securely into the rear holders. Otherwise, it is not properly secure for transport.

Payment system

This washer-extractor can be fitted with a payment system.*

This must be connected and programmed by a Miele service technician or authorised dealer.

Coins / tokens must be removed from the payment system regularly, otherwise it will become blocked.

Do not use devices to turn the machine off automatically, (e.g. automatic timers).

* All items marked * are available to order from your Miele Dealer or from the Miele Spare Parts Department.

Installation and connection

Installation surface

⚠ Do not install the machine near or directly above an open gully or floor drain. Moisture from these can penetrate the machine and damage the electric components.

A concrete floor is the most suitable installation surface, being far less prone to vibration during the spin cycle than wooden floorboards or a carpeted surface.

⚠ If the machine is installed on an on-site concrete or brick plinth, it **must** be secured using the clamps supplied with the machine. Otherwise there is the danger of the machine moving about.

- The machine must be level and securely positioned.
- To avoid vibrations during spinning, the machine should not be installed on soft floor coverings.

If installing on a wooden joist floor:

- We recommend a plywood base (at least 70 x 60 x 3 cm). The base should span several joists and be bolted to the joists and not only to the floorboards. Check for the presence of pipes and cables first.

If possible, install the machine in a corner, as this is usually the most stable part of the floor.

Installing the washer-extractor

To manoeuvre the machine out of its packing case to its installation site, hold it by the edge of the lid where it protrudes to the rear of the machine as well as by the handle recesses at the front.

Please note:

- Do not lift the machine by the drum door.

⚠ Ensure that the machine feet and the floor are dry to prevent the machine from slipping during the spin cycle.

Removing the transit fittings

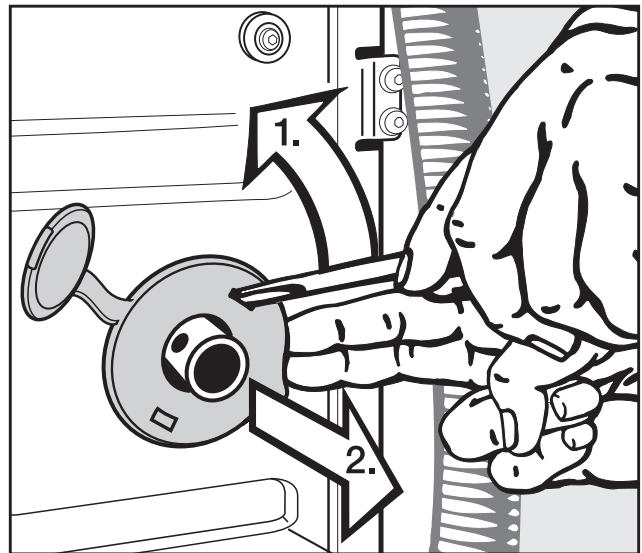

- To remove the left and right covers
 1. Use a screwdriver to prise out the cover as illustrated.
 2. Pull the cover forwards to remove.

Installation and connection

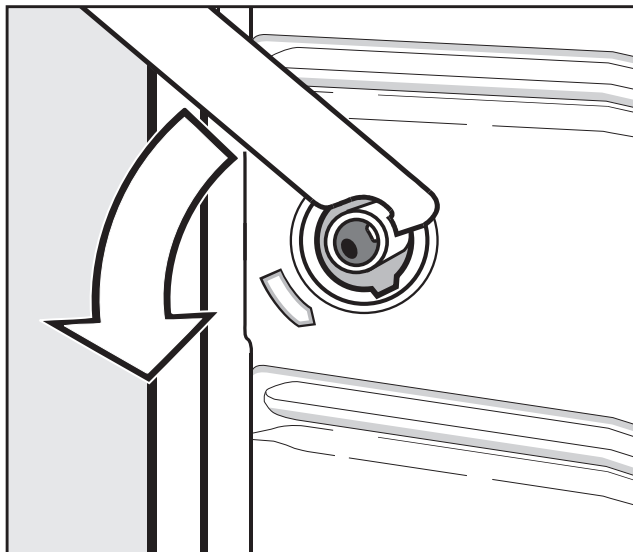

- Using the spanner supplied turn the left-hand transit bar 90°, then

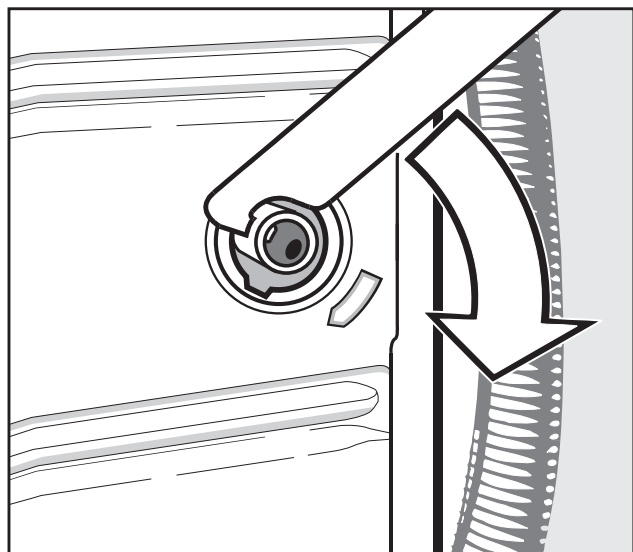

- Turn the right-hand transit bar 90°, then

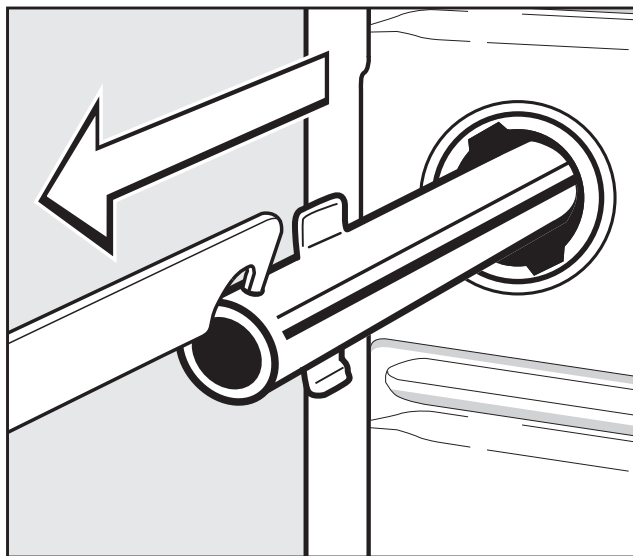

- withdraw the transit bar.

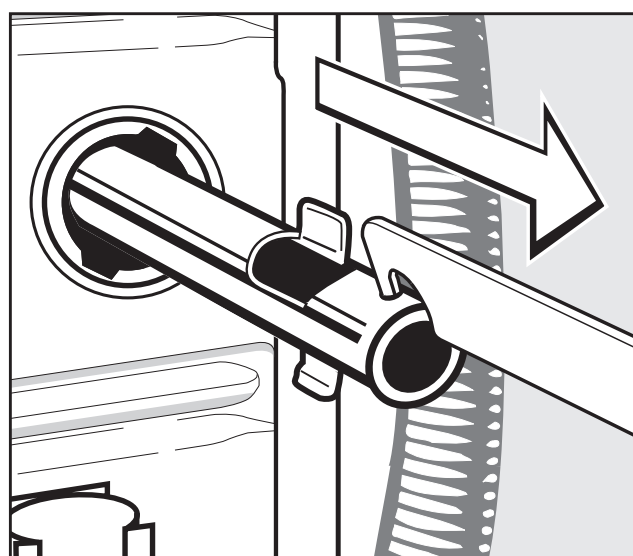

- withdraw the transit bar.

Installation and connection

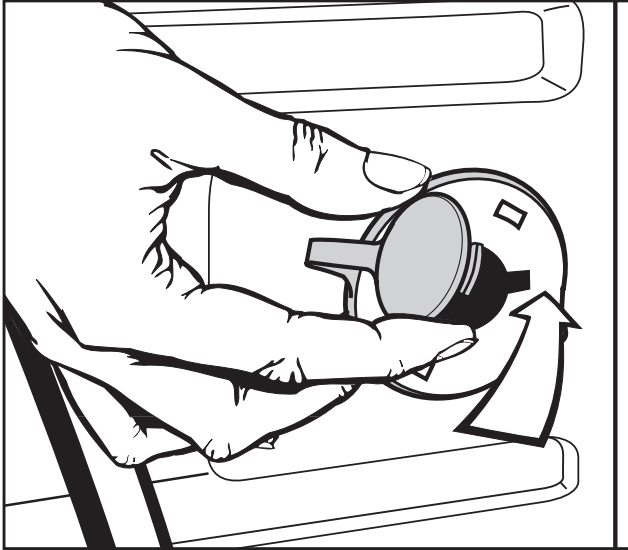

⚠ The machine must not be moved without the transit fittings in place. Store them as shown or keep them in a safe place for future use. They must be re-fitted if the machine is to be moved again (e.g. when moving house).

Re-fitting the transit bars

Re-fitting is carried out by reversing the procedure.

- Fit the covers on to the two holes. Then plug the holes as shown with the caps.

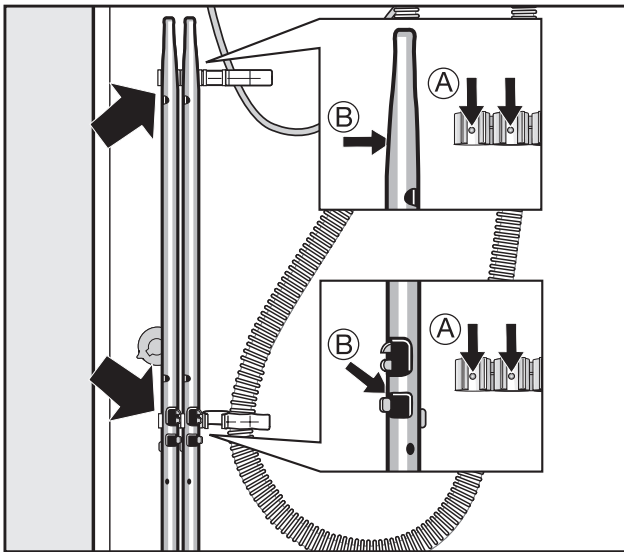

- Secure the transit bars to the back of the washer-extractor. Make sure that holes **(B)** are fitted over retainers **(A)**.

Installation and connection

Levelling the machine

The machine must stand perfectly level on all four feet to ensure safe and proper operation.

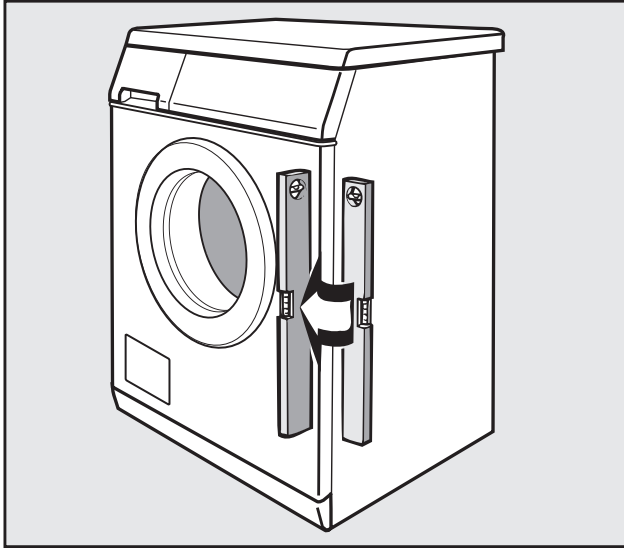

Incorrect installation may increase electricity and water consumption and may cause the machine to move about.

Screwing out and adjusting the feet

The four adjustable screw feet are used to level the machine. All four feet are screwed in when the machine is delivered.

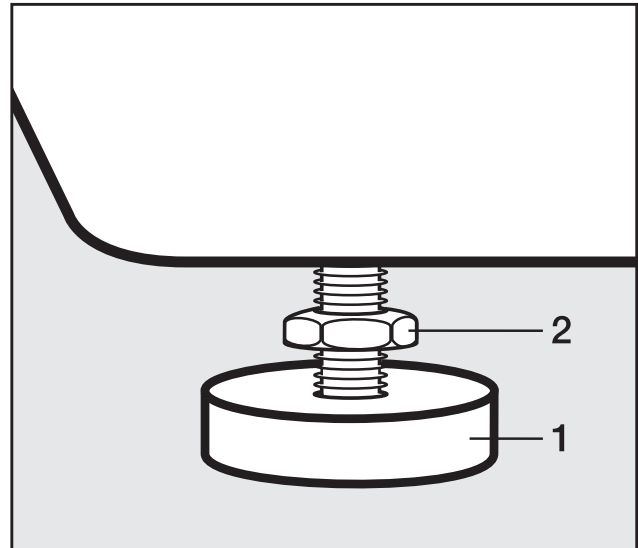

- Using the spanner supplied turn counter nut **2** in a clockwise direction. Then turn counter nut **2** together with foot **1** to unscrew.
- Use a spirit level to check the machine is standing level.
- Hold foot **1** securely with a pipe wrench. Turn counter nut **2** again using the spanner supplied until it sits firmly up against the housing.

 All four counternuts must sit firmly up against the housing. Please also check this for the feet which did not need adjustment. Otherwise there is the danger of the machine moving about.

Plumbing

This machine is approved for all UK applications as suitable for category 5. The product is listed in the WRAS regulations advisory scheme directory and is suitable for direct connection to mains drinking water. No special plumbing arrangements e.g. break tanks are required.

A Water Council approved check valve is supplied in the accessories pack provided with this machine. It should be fitted in between the stopcock(s) and the water inlet hose(s).

The machine should be connected to a mains water supply in accordance with local and national safety regulations.

The machine is designed to operate with a flow pressure of between 1 and 10 bar (100 kPa and 1,000 kPa). At higher water pressures it is essential to fit a reducer valve.

Connection to the water supply should be carried out by a qualified plumber and should incorporate a stopcock with a 3/4" thread. The stopcock should be fitted by a qualified plumber.

The machine is supplied as standard with two hoses, for connection to a hot and cold water supply.

Connection to the cold water supply

The cold water inlet hose (blue stripes) must be connected to the on-site cold water supply via a 3/4" threaded union. It is **not** suitable for connection to a hot water supply.

 The connection point is subject to mains water pressure. Turn on the stopcock slowly and check for leaks. Correct the position of the washer and union if appropriate.

Maintenance and care

Only use a genuine Miele hose should you ever need a replacement. Miele hoses are tested to withstand pressure of at least 70 bar (7,000 kPa).

In order to protect the water inlet valve, the two dirt filters - one in the open end of the inlet hose, one at the inlet point in the machine must not be removed.

Extension hose

Longer hoses 2.5 or 4.0 m in length are available from your Miele dealer or the Miele Spare Parts Department as optional extras.

Installation and connection

Connection to the hot water supply

To keep electricity consumption costs down this machine can be connected to a **(ring) piped hot water supply**. The maximum temperature must not exceed 70°C.

It is not economical to run it from an individual hot water supply if it is not in continuous use, as the water in the supply pipes cools down and more energy would be required to reheat the water.

For hot water connection the same conditions apply as for cold water connection.

The inlet hose with the red stripes (hot water hose) is connected to the stopcock.

For operational reasons the machine must not be connected to hot water only.

If the machine is **not** connected to a hot water supply, the water settings for the *main wash*, *pre-wash* and *rinses* must be re-programmed.

- Go to *Settings menu/Supervisor level* and select the *Cold* option for each of the above. The *Settings/Supervisor level* needs to be activated by a Miele service technician.

The programme durations may be longer.

- Unscrew the inlet hose (hot water - red stripes)
- Plug the inlet connection with the cap supplied.

Connection to a very hot water supply

It is possible to connect the machine to a very hot water supply, 70°C to a maximum of 85°C. A special inlet hose is required. The machine must also be reprogrammed by a Miele service technician or Miele authorised service dealer.

Connection to drainage

Machines with a drain pump

The machine drains via a drain pump with a delivery head of 1 metre*. The drain hose must not be kinked as this would restrict drainage. The swivel elbow at the end of the hose can be turned in either direction, or can be detached if required, with a sharp twist and pull.

* For a delivery head of more than 1 m (up to a max. of 1.8 m) a second duo-drain pump is available with the corresponding kit from the Miele Spare Parts Department or your Miele Dealer.

The drain hose may be connected as follows:

1. Direct into a sink or basin (drain pump version):

Please note:

- Hook the hose over the edge and secure.
 - Make sure that the water can drain away freely without hindrance. Otherwise there is a risk of water overflowing or of some of the drained water being sucked back into the machine.
2. Connected securely to a plastic drain pipe with a rubber nipple. There is no need to use a non-return valve.
 3. Connected securely to a standpipe. (Seal the hose into the pipe to avoid flooding in case of the drainpipe being blocked).
 4. Connected securely to a floor gully.

If required the drain hose can be extended to a length of 5 m. The necessary parts can be purchased from the Miele Spare Parts Department or your Miele dealer.

Drain valve version

A motorised drain valve is used to drain the machine. A DN 70 angle connector can be used for draining the machine via an on-site gully (with odour trap). N.B. If not supplied with the machine an angle connector is available through the Miele Spare Parts Department.

Installation and connection

Electrical connection U.K.

All electrical work must be carried out by a suitably qualified and competent person, in strict accordance with national and local safety regulations.

Ensure power is not supplied to the machine until after installation work has been carried out.

The voltage, rated load and fuse rating are given on the data plate. Please ensure these match the site mains supply.

This washer-extractor is supplied as standard for connection to either:

- 230 - 240 V / 1 N / 50 Hz,
25 A fuse rating

or:

- 400 V / 2N / 50 Hz,
2 x 15 A fuse rating

Connection should be made via a suitable isolator which complies with national and local safety regulations, and the on/off switch should be easily accessible for servicing work.

For extra safety it is advisable to install a residual current device (RCD) with a trip current of 30 mA (in accordance with DIN VDE 0664, VDE 0100, Section 739).

When switched off there must be an all-pole contact gap of 3 mm in the isolator switch (including switch, fuses and relays acc. to VDE 0660).

Important

for **400 V** connection, the machine is supplied with a cable in the following colours:

Black = live

Brown = live

Blue = neutral

Green and yellow = earth

WARNING THIS APPLIANCE MUST BE EARTHED

 Do not use devices to turn the machine off automatically, (e.g. automatic timers).

Technical data

Height	85.0 cm
Width	59.5 cm
Depth	72.0 cm
Depth with door open	112 cm
Weight	109 kg
Maximum floor load	2778 Newton (approx. 278 kg)
Capacity	6.5 kg dry laundry
Voltage	see data plate
Connected load	see data plate
Fuse rating (UK)	see data plate
Noise level during spin (sound pressure according to German 3. GSGV)	< 70 dB (A)
Water flow pressure min.	100 kPa (1 bar)
Water flow pressure max.	1000 kPa (10 bar)
Inlet hose length	1.60 m
Connection cable length	1.60 m
Drain pump head max. (applies to drain pump machines only)	1.00 m
Lamp for drum lighting	Type G4 (5 watts/12 volts)
Test certificates awarded	Radio/TV suppression, VDE

Settings menu for changing standard settings

The Settings menu is used to alter the machine's electronics to suit different requirements.
Settings can be altered at any time.



Settings menu

To open the Settings menu

Cottons Hygiene 95°C	Minimum iron	40°C
Cottons Uni. 60°C	Minimum iron	30°C
Cottons Uni. 40°C	Denim	40°C
Minimum iron 60°C	Delicates	30°C ▼

- In the Programme selection menu, turn the multi-function selector until *Settings*  is highlighted and press the multi-function selector to confirm your selection.

Selecting settings

Settings	Back 
	Language 
	Water plus
	Suds cooling ▼

- Select the setting you want to change, and confirm your selection.

If you do not make a selection in the sub-menu within approx. 20 seconds, the menu display will revert to the *Settings* menu.

Although the *Water plus*, *Time of day* and *Memory* settings are visible in the display they are not available on this model.

To close the Settings menu

- Select *Back* and confirm your selection. The display will return to the entry menu.

Language

The display can be set to appear in one of several different languages.

To select the language you want, go to the *Languages*  sub-menu.

- Select the language you want and confirm your selection.

The flag after the word *Language* acts as a guide to prevent a language which will not be understood from being set.

The different language setting will only apply to the programme currently in use. After the programme has finished the display will revert to the default language which was set in the *Settings/Supervisor level* menu.

Water plus

This option is visible in the display, but not available on this machine!

Suds cooling

When this is activated, additional water flows into the drum at the end of the main wash to cool the suds down. Hot suds can damage plastic drainage pipes.

Suds cooling takes place when temperatures of more than 70°C are selected.

Suds cooling should be activated:

- to prevent the danger of scalding if the drain hose is hooked over the edge of a sink or basin.
- where the drainage pipes do not comply with DIN 1986.

The machine is delivered with Suds cooling activated.

Settings menu

Time of day

This option is visible in the display, but not available on this machine!

Display contrast

There are ten different display contrast settings.

The machine is delivered with the display contrast on Setting 4.

The display contrast will change as soon as a different setting is chosen.

- Confirm your selection with the multi-function selector.

Display brightness

There are ten different display brightness settings.

The machine is delivered with the display contrast on Setting 5.

The display brightness will change as soon as a different setting is chosen.

- Confirm your selection with the multi-function selector.

Standby

To save energy, the display goes out after 10 minutes and the *Start* button flashes slowly.

There are two options:

On

Stand-by comes on:

- if a programme is not selected after the machine has been switched on.
- after a programme has started.
- at the end of a programme.

Not in current Prog. (the machine is delivered with this option selected)

Standby comes on:

- if a programme is not selected after the machine has been switched on.

Operating the multi-function selector switches the display back on again.

Memory

This option is visible in the display, but not available on this machine!

Temperature units

You can chose for the temperature to be displayed as °C/*Celsius* or °F/*Fahrenheit*.

The machine is delivered with the °C option selected.

Settings/Supervisor level menu

The *Settings/Supervisor level* needs to be activated by a Miele service technician or authorised dealer.

The *Settings/Supervisor level* is locked with a code to prevent it being accessed by unauthorised personnel.

Selecting settings

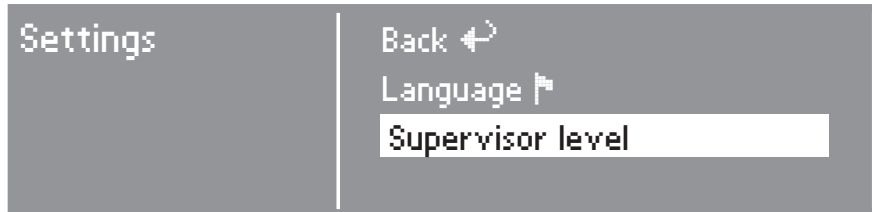

- Select *Supervisor level* and confirm your selection.



- Select *Access via code* and confirm your selection.

To enter the code

Enter the code **0 0 0** (factory default setting). If you enter the code wrongly three times, the machine will lock out for an hour!

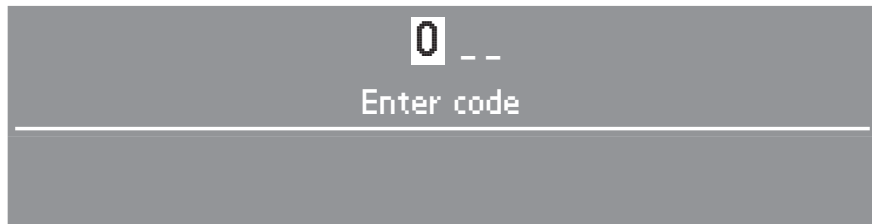

- Turn the multi-function selector until the first number appears. Confirm your selection of this number. Now set the second number.

Settings/Supervisor level menu

Repeat the process until all three numbers have been entered.

To confirm the lock code



- Confirm the code.

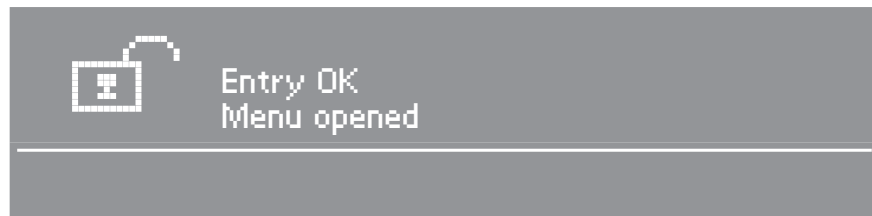

You are now in the Supervisor level. You can alter all the settings described previously as well as the settings on the following pages.

Although the settings *Sort languages*, *Language menu*, *Intensive Water plus*, *Save*, *Hygiene* and *Disinfection* are visible in the display they are not available on this model.

You can alter the code if you want to prevent it being accessed by unauthorised personnel.

Settings/Supervisor level menu

Language

The display can be set to appear in one of several different languages.

You can set the language you want as the fixed default language in the *Languages*  sub-menu.

- Select the language you want and confirm your selection.

Sort languages

This option is visible in the display, but not available on this machine!

Supervisor level

You can alter the access code to the supervisor level.

- Enter the old code.
- Enter a new code.

After you have confirmed the new code, the display will change to the beginning of the *Settings* menu.

Language menu

This option is visible in the display, but not available on this machine!

Intensive Water plus

This option is visible in the display, but not available on this machine!

Save

This option is visible in the display, but not available on this machine!

Settings/Supervisor level menu

Auto load control

The washer-extractor has auto load control. The water level and the programme durations are adjusted according to the load. If the auto load control is deactivated, the machine will always carry out the programme sequence based on a full load.

The machine is delivered with this option activated.

Pre-wash water

You can choose for the pre-wash to be carried out with either hot or cold water (not available with the *Curtains* programme). Hot water can only be only taken in if the wash temperature is above 30°C.

The machine is delivered with the *Hot* water option selected.

Main wash water

You can choose for the main wash to be carried out with either hot or cold water (not available with the *Woollens*, *Silks* and *Curtains* programmes). Hot water can only be only taken in if the wash temperature is above 30°C.

The machine is delivered with the *Hot* water option selected.

If the machine is not connected to the hot water supply, the programme durations will be longer and will vary from the time remaining shown in the display.

The machine will need to be set up specifically for *Recycled water* if this option is selected.

Rinse water

You can choose for the rinses in the *Cottons*, *Minimum iron Table linen*, *Kitchen linen*, *Towelling* and *Sluice* programmes to be carried out with either hot or cold water. Hot water can only be only taken in if the wash temperature is above 50°C.

The machine is delivered with the *Hot* water option selected.

The machine will need to be set up specifically for *Recycled water* if this option is selected.

Settings/Supervisor level menu

Water level Cottons

You can increase the water level for the main wash in the *Cottons* programme.

The machine is delivered with the Block parameters option selected (the water level will be controlled according to the programme data which has been programmed ex-works).

Water level Min. iron

You can increase the water level for the main wash in the *Minimum iron* programme.

The machine is delivered with the Block parameters option selected (the water level will be controlled according to the programme data which has been programmed ex-works).

Pre-wash temp. cot.

You can the temperature you want the pre-wash to be carried out at in the *Cottons* programme.

The machine is delivered with the Block parameters option selected (the temperature will be controlled according to the programme data which has been programmed ex-works).

Pre-wash duration

You can lengthen the duration of the pre-wash.

The machine is delivered with the Block parameters option selected (the wash duration will be controlled according to the programme data which has been programmed ex-works).

Wash time Cottons

You can increase the wash duration for the main wash in the *Cottons* programme.

The machine is delivered with the Block parameters option selected (the wash duration will be controlled according to the programme data which has been programmed ex-works).

Wash time Min. iron

You can increase the wash duration for the main wash in the *Minimum iron* programme.

The machine is delivered with the Block parameters option selected (the wash duration will be controlled according to the programme data which has been programmed ex-works).

Settings/Supervisor level menu

No. of programmes

You can extend the number of programmes available.

0 additional programmes (the machine is delivered with this option selected).

4 additional programmes (*Table linen*, *Pillows*, *Curtains* and *Kitchen linen*).

2 additional programmes (*Outerwear* and *Proofing*).

6 additional programmes (all the above named programmes).

Hygiene

This option is visible in the display, but not available on this machine!

Sluice

When the Sluice option is selected the *Sluice Low* and *Sluice High* programmes are available.

The machine is delivered with this option deactivated. N.B. This option must not be activated on machines equipped with a drain pump! These programmes are only suitable for use on machines fitted with a drain valve.

Disinfection

This option is visible in the display, but not available on this machine!

Pre-wash

You can choose for pre-wash to be carried out with every *Cottons* and *Minimum iron* programme or to select it on an individual basis via the screen menu.

The machine is delivered with the *Menu selection* option activated for pre-wash.

2. Pre-wash Kitchen linen

An additional pre-wash can be carried out in the *Kitchen linen* programme.

Detergent for the additional pre-wash should be added to the laundry in the drum.

The machine is delivered with this option deactivated.

Settings/Supervisor level menu

Optimise energy

When this option is selected, the machine will optimise the energy it uses in the *Cottons* and *Minimum iron* programmes.

The machine is delivered with this option activated.

No. rinses Cottons

You can alter the number of rinses which are carried out in the *Cottons* programmes.

- 2 rinses (standard setting)
- 3 rinses
- 4 rinses
- 5 rinses

No. rinses Min. iron

You can alter the number of rinses which are carried out in the *Minimum iron* programme.

- 2 rinses (standard setting)
- 3 rinses
- 4 rinses

Pre-rinse Cottons

A pre-rinse can be carried out in the *Cottons* programmes.

The machine is delivered with this option deactivated.

Pre-rinse Min. iron

A pre-rinse can be carried out in the *Minimum iron* programme.

The machine is delivered with this option deactivated.

Spin free of charge

If your machine is fitted with a payment system, you can release the *Spin* programme (Free of charge).

The machine is delivered with this option deactivated.

No detergent

If your machine is fitted with an external dispensing system, the system will not be used when *No detergent* is selected. You can choose whether or not you want *No detergent* to appear as an option in the *Extras* menu.

The machine is delivered with this option deactivated.

To close the Settings menu

- Select *Back* and confirm your selection. The display will return to the entry menu.

External dispenser

This machine is suitable for connecting to an external dispensing system. This external dispenser setting must be selected before the external dispensing system can be used.

The machine is delivered with this option deactivated.

**United Kingdom:**

Miele Co. Ltd.
Fairacres, Marcham Road
Abingdon, Oxon, OX14 1TW
tel. Abingdon (01235) 554455
Service Office: (01235) 554466
fax (01235) 554477
Internet: www.miele.co.uk

Ireland:

Miele Ireland Ltd.
Broomhill Road, Tallaght, Dublin 24
Tel: (01) 46 10 710, Fax: (01) 46 10 797
Email: info@miele.ie
Internet: <http://www.miele.ie>

Australia:

Miele Australia Pty. Ltd.
A.C.N. 005635398
1 Gilbert Park Drive
Knoxfield, VIC 3180
Telephone: (03) 9764 7100
Fax: (03) 9764 7129
Internet: www.miele.com.au

Distributor New Zealand:

Steelfort Engineering Company. Ltd.
500 Rangitikei Street
Palmerston North, Priv. Bag 11045, NZ
Telephone: (06) 350 1350
Fax: (06) 356 1507

South Africa:

Miele (Pty) Ltd
63 Peter Place
Bryanston 2194
P.O. Box 69434
Bryanston 2021
Tel.: (011) 548 1900
Telefax (011) 548 1935
Internet: www.miele.co.za
E-mail: info@miele.co.za

Singapore:

Miele Southeast Asia
Miele Pte. Ltd.
163 Penang Road
04 - 02/03 Winsland House II
Singapore 238463
Tel : +65-67351191
Fax: +65-67351161
Email: infosea@miele.com.sg

Hong Kong:

Miele (Hong Kong) Limited
AIA Plaza, 24th Floor
18 Hysan Avenue
Causeway Bay
Hong Kong
Tel.: (852) 2610 1331
Fax: (852) 2610 1013
E-mail: mielehk@miele.com.hk