

SIEMENS

Instruction Manual and Installation Instructions

en

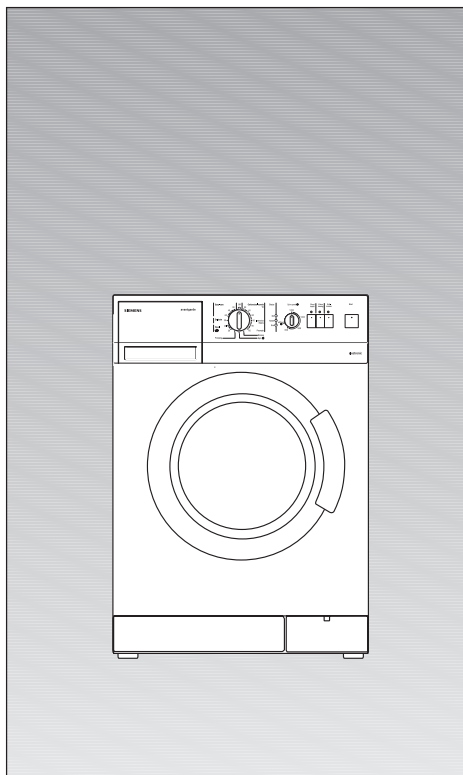

avantgarde

Table of Contents

Operating Instructions

Disposal Information	4
Environmental Protection / Conservation Issues	5
General Safety Instructions	6
Your New Washing Machine	7
Before Using Your Washing Machine For the First Time	9
Preparing, Sorting and Loading the Laundry	10
Laundry Detergents and Additives	15
Selecting Programmes	17
Washing	21
When the Programme has Ended	23
Special Applications	24
Cleaning and Care	26
Troubleshooting Minor Faults	31
Customer Service	34
Consumption Rates	35
Installation, Connection and Transport	36

Installation Instructions

Please read this instruction manual and all other information accompanying the washing machine before operating the appliance.

Please retain all documents for future reference or for a subsequent appliance owner.

Disposal Information

Disposing of the packaging

The shipping package has protected your new appliance on its way to your home. All packaging materials are environment-friendly and recyclable. Please contribute to a better environment by disposing of packaging materials in an environmentally conscious manner.

Please ask your dealer or local authority about best means of disposal.

⚠ Danger of suffocation!

Keep children away from shipping carton and packaging components. Danger of suffocation from plastic film and folding cartons.

Disposing of your old appliance

Old appliances are not worthless rubbish! Environment-conscious recycling can reclaim valuable raw materials.

⚠ Danger of fatal injury!

On out-of service appliances, unplug mains plug. Cut off power cord and discard with mains plug.

To prevent playing children from becoming trapped and endangered, ensure that the door locking mechanism is disabled.

Environmental Protection / Conservation Issues

Your washing machine uses water, energy and detergent efficiently, thereby protecting the environment and reducing your household costs. See Page 35 for consumption values of your appliance.

Using your washing machine in an efficient and environmentally friendly manner:

- Do not exceed the maximum load specifications:

Cottons/coloureds	6.0 kg / 13.2 lb
Easy-care	3.0 kg / 6.6 lb
Delicate and Wool	2.0 kg / 4.4 lb

For small amounts of laundry, the automatic water level control system reduces the consumption of both water and energy.

- Where possible, use the 60 °C “Intensive Stains” programme instead of the 90 °C “Cottons/coloureds” programme. The extended washing duration means that a cleaning result comparable to that of the 90 °C programme is achieved using considerably less energy.
- Avoid using the Prewash programme when washing lightly to normally soiled laundry.
- Add detergent according to the degree of soiling, amount of laundry and water hardness, and observe the detergent manufacturer’s instructions.

General Safety Instructions

Your washing machine is intended:

- For domestic use only.
- For washing machine-washable fabrics in washing solution.
- For operation using cold and hot (70 °C) tap water and conventional laundry detergents and additives that are suitable for use in washing machines.

Do not leave children unsupervised near the washing machine.

Keep pets away from the washing machine.

Do not insert/pull out the mains plug with wet hands.

Do not pull out the mains plug by tugging the cable.

Do not touch the loading door if washing at high temperatures.

Caution when draining hot water.

Do not climb onto the washing machine and do not lean on the open loading door.

Your New Washing Machine

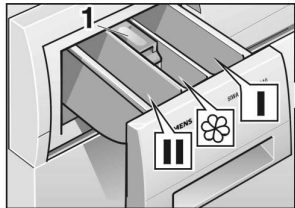

Filling laundry detergent and/or additive dispensers

Dispenser I:
Detergent for prewash or starch.

Dispenser II:
Detergent for main wash, soaking agent, softener, bleach or stain remover.

Dispenser ☼:
Cleaning product, e.g. fabric softener, fabric conditioner (do not fill above the lower edge of the insert 1).



Open the loading door ...



and close it.

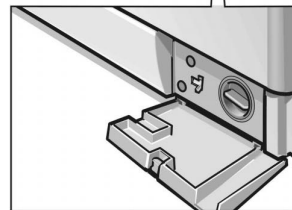

Drain washing solution if necessary

Control panel

1. Select a programme

Switches on / off the washing machine.

Can be turned in both directions.

The programme selector cannot be turned when the programme is in progress. The programme sequence is controlled electronically.

2. Control lights illuminate

“On” when programme is selected.

“Active” when “Start” is pressed.

“End” when programme is finished.

Flashing control lights = operating fault.

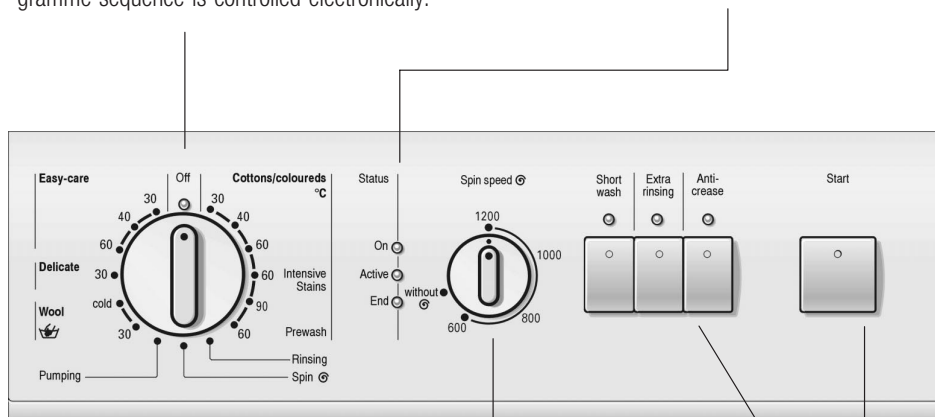

3. Set the spin speed (if desired)

Variable; must click into place at “without”.

4. Press buttons for additional functions

(where required to supplement the programme)

“Short wash”: Shortened programme duration.

“Extra rinsing”: Additional rinsing cycle.

“Anticrease”: Reduces creasing.

It is also possible to combine the additional functions at any time.

The control light above the option button lights up when the respective additional function is active.

To cancel the additional function: Press the button again.

5. Press the “Start” button

The washing process begins (programme must have been selected).

Before Using Your Washing Machine For the First Time

The washing machine must have been installed and connected properly (refer to Page 36).

Your appliance was tested before leaving the factory. To remove any water left over from testing procedures, the first washing cycle should be carried out without laundry in the machine.

- Do not load any laundry.
- Turn on the water tap.
- Pull out the detergent dispenser up to the end stop.
- Pour approx. 1 litre / 1 ¼ pt of water into chamber **II** of the detergent dispenser.
- Half fill the measuring beaker with detergent and pour into chamber **II**. Do not use any special detergents for delicates or woollens (excessive foam).
- Close the detergent dispenser.
- Set the programme selector to "90 °C Cottons/coloureds".
The "On" control light comes on.
- Press the "Start" button.
The "Active" control light comes on.

When the "End" control light comes on:

- Set the programme selector to "Off".

Preparing, Sorting and Loading the Laundry

Preparing the laundry

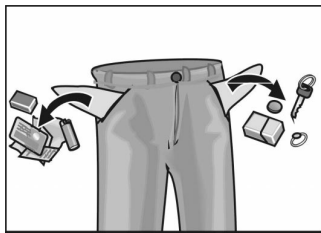

Caution

Loose debris (e.g. coins, paper clips, needles, nails) can damage items of clothing as well as parts of the washing machine (e.g. drum).

- Empty all pockets on items of clothing.
- Brush out any sand from pockets and cuffs.
- Close zip-fasteners and button up bed covers.
- Remove curtain runners or tie them up in a net / bag.
- The following items must be washed inside a net / pillow case:
 - Extremely delicate items, e.g. fine tights, net curtains.
 - Small items, e.g. small socks or handkerchiefs.
 - Underwired bras (the wire may come loose during washing and cause damage).
- When washing trousers, knitwear and woven fabrics, e.g. shirts, T-shirts or sweatshirts, always turn these items inside out.

Sorting the laundry

According to colour and degree of dirt

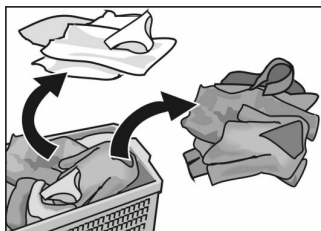

Degrees of dirt

Caution

Items of clothing can become discoloured. Never wash new multi-coloured items together with other items.

White items may become grey. Always wash white and coloured items separately.

Slight dirt

No recognizable dirt or staining. Laundry may have some body odour.

- Light summer clothing and sportswear that has only been worn for a few hours.
- T-shirts, shirts and blouses that have been worn for up to one day.
- Bed linen and guest towels that have been used for one day.

Normal dirt

Visible dirt and/or some light staining recognizable.

- T-shirts, shirts and blouses that are very sweaty or have been worn several times.
- Underwear that has been worn for one day.
- Tea towels, hand towels and bed linen that have been used for up to one week.
- Net curtains (without nicotine staining) that have not been washed for up to ½ year.

Intensive dirt

Dirt and/or staining recognizable.

- Kitchen hand towels that have been used for up to one week.
- Fabric napkins.
- Bibs.
- Children's outer clothing or football shirts and shorts with grass and soil stains.
- Working clothes such as overalls or baker's and butcher's coats.

Typical stains

- Skin fat, cooking oils / fat, sauces, mineral oil, wax (containing fat / oil).
- Tea, coffee, red wine, fruit, vegetables (bleachable).
- Blood, egg, milk, starch (containing protein / carbohydrate).
- Soot, soil, sand (pigments), red sand on tennis clothes.

Removing stains

Wherever possible, remove / pretreat stains whilst they are still fresh.

First, dab soapy water onto the stain. Do not rub.

Subsequently wash the items of clothing using the appropriate programme.

Several washing cycles may sometimes be required in order to remove stubborn / dried in stains.

Sorting laundry according to their care label specifications

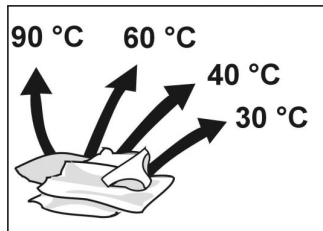

Only wash laundry that is labelled with the following care symbols:



90 °C Cottons/coloureds



60 °C, 40 °C, 30 °C Cottons/coloureds



60 °C, 40 °C, 30 °C Easy-care



40 °C, 30 °C Delicate



40 °C, 30 °C Wool (hand and machine-washable)

Laundry that is labelled with the following care symbol must not be washed in the washing machine:

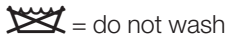

Loading the laundry

⚠ Risk of explosion!

Items of clothing that have been pretreated with solvent-based cleaning agents, e.g. stain remover and dry cleaning spirit, represent an explosion hazard once loaded into the washing machine. Therefore, these items must first be rinsed thoroughly by hand.

Caution

Loose debris in the washing machine drum can damage the laundry. Before loading the laundry, check that there is no debris in the drum.



- Open the loading door.

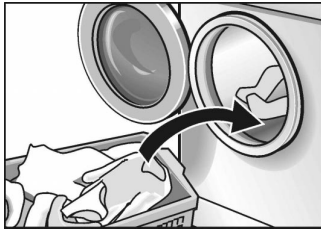

- Unfold the sorted items of clothing and place them loosely into the drum. Mix up large and small items.
Items of varying size will distribute better during the spin cycle.
- Do not exceed the maximum load: Overloading will cause poor wash results and encourage creasing.

When washing a small amount of laundry, the washing machine automatically reduces the amount of water and energy used.



- Close the loading door.
Take care not to trap any items of clothing between the loading door and rubber seal.

Laundry Detergents and Additives

Dispensing the correct amount of detergent

⚠ Risk of poisoning!

Keep detergents and additives out of the reach of children.

Dispense the detergent according to:

- the water hardness. This information can be obtained from your local water authority.
- the amount of laundry.
- the amount of soil. Information on soiling can be found on Page 11.
- the specifications of the detergent manufacturer. Dispensing the correct amount of detergent relieves the strain on the environment and ensures optimum washing results.

Pour liquid detergent into the appropriate dispensing chamber.

Too little detergent:

The laundry is not cleaned properly and will, after a while, become grey and stiff.

Greyish brown spots (fat globules) may appear on the laundry. The heaters may calcify.

Too much detergent:

Environmentally incompatible, excessive foam reduces wash agitation causing poor washing and rinsing results.

Filling laundry detergent and/or additive dispensers

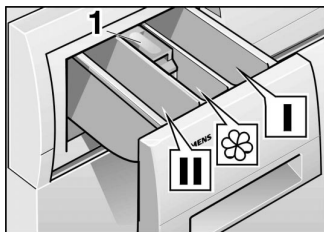

Dispenser I:
Detergent for prewash or starch.

Dispenser II:
Detergent for main wash, soaking agent, softener, bleach or stain remover.

Dispenser ☼:
Cleaning product, e.g. fabric softener, fabric conditioner.

- Fill at least to lower edge of insert **1**.
 - If the liquid additive is thick, mix with a little water before dispensing (prevents clogging of the overflow).
- Pull out the detergent dispenser up to the end stop.
 - Add the detergent and/or additive.
 - Close the detergent dispenser.

Selecting Programmes

Basic programmes

Select the desired programme (refer also to separate "Programme Chart").

90 °C Cottons/coloureds

An energy-intensive programme for heat-resistant textiles, e.g. cotton or linen.

To protect the drainage pipes, the hot water is mixed with approx. 7 litres of cold water before being drained.

60 °C Intensive Stains

For stained, heavily soiled textiles, e.g. cotton or linen. Energy-saving programme. The extended washing time achieves a cleaning result comparable to that of the 90 °C programme, but uses considerably less energy.

60 °C Cottons/coloureds with Prewash

For heavily soiled, hard-wearing textiles, e.g. cotton or linen.

Select this programme in order to remove stains containing protein from your laundry.

30, 40, 60 °C Cottons/coloureds

For hard-wearing textiles, e.g. cotton or linen.

30, 40, 60 °C Easy-care

For easy-care textiles, e.g. cotton, linen, synthetic materials or blended fabrics.

**Extra cycle
programme selector**

30 °C Delicate

For delicate, washable textiles, e.g. silk, satin, synthetic materials or blended fabrics (e.g. curtains).

Delicates cycle at 30 °C for hand and machine washable silk.

We do not recommend washing these textiles with other rougher textiles.

To treat very delicate silk textiles even more gently, reduce the time by pressing the “Short wash” button.

No spinning between rinse cycles.

Maximum spin speed: 600 r.p.m.

30 °C, Wool  cold

For hand and machine washable wool or wool-rich textiles, e.g. cashmere, mohair or angora.

Rinsing

Rinse cycle with subsequent spin cycle for rinsing hand-washed laundry or for starching.

Maximum spin speed: 800 r.p.m.

Spin 

Spin cycle for spinning hand-washed laundry. Water is drained before the spin cycle.

Maximum spin speed: 800 r.p.m.

Pumping

Water is drained after a programme with the “without ” setting for gentle treatment of delicate laundry.

Spin speed selector

Basic setting =

Spin speed selector pointing upward

In the “Cottons/coloureds” programme the fabrics will be spun at the maximum possible spin speed.

In the “Easy-care”, “Delicate” and “Wool” programmes, a lower spin speed will automatically be used, regardless of the position of the spin speed selector – for the gently washing of the laundry.

Maximum spin speeds

Revolutions per minute	Type of laundry / Extra cycle
1200	Cottons/coloureds
800	Easy-care
600	Delicate
800	Wool
800	Rinsing
800	Spin 

Additional function on spin speed selector

without

For delicate laundry and net curtains. The laundry remains lying in the water after the final rinse. Before the laundry can be unloaded, the “Pumping” or “Spin ” programme must be performed.

Additional options buttons**Short wash**

Reduced washing duration – only 2 rinsing cycles.
Suitable for slightly dirty laundry.

Recommended load amount: Up to a maximum
of 3 kg.

Extra rinsing

An additional rinse cycle is implemented; washing
time is extended accordingly.

Recommended in soft-water areas.

Anticrease

Special spin sequence with subsequent loosening of
the washing.

After the spin cycle the washing is arranged loosely in
the drum – creasing is reduced.

The maximum speed is automatically reduced to
800 r.p.m. for the “Cottons/coloureds” programmes.

Observe maximum load for each type of textile;
remove the washing as soon as the spin cycle is
complete.

Washing



- Turn on the water tap.

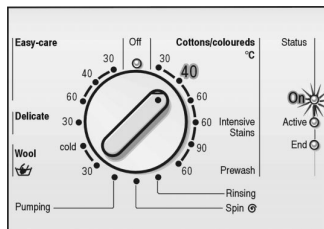

- Turn the programme selector to the desired programme (refer also to separate “Programme Chart”).
The “On” control light comes on.

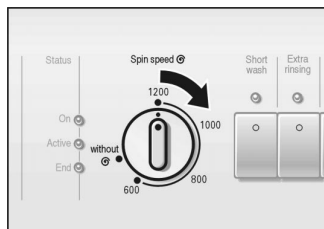

- Select the desired spin speed or “without”.

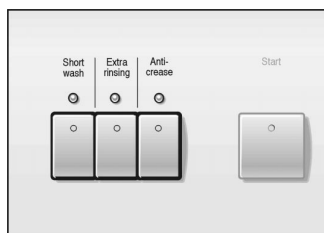

- Where required, press the option button(s) for additional function(s).

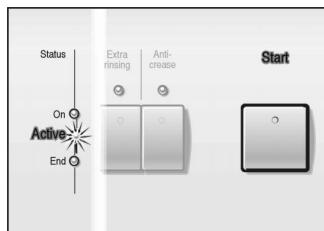

- Press the “Start” button.
The “Active” control light comes on, and the programme starts.

The “Active” control light remains lit for the entire duration of the programme.

Changing a programme

If you have accidentally selected the wrong programme:

- Turn the programme selector to “Off”.
- Turn the programme selector to the desired programme.
The “On” control light comes on.
- Press the “Start” button.
The “Active” control light comes on, and the new programme starts.

Cancelling active programme

If you wish to prematurely end a programme:

- Turn the programme selector to “Off”.
- Turn the programme selector to “Pumping” or “Spin \odot ”.
The “On” control light comes on.

For “Spin \odot ”, select the desired spin speed (but not “without \odot ”).

- Press the “Start” button.
The “Active” control light comes on.

When the Programme has Ended

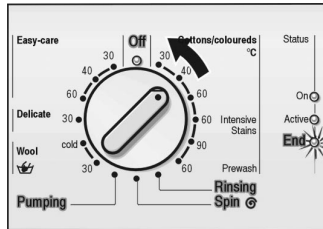

The “End” control light comes on.

- Turn the programme selector to “Off”, and, where required:
- Select a programme option (“Pumping”, “Spin” or “Rinsing”).
- Press the “Start” button.
- At the end of the programme option, turn the programme selector to “Off”.

Unloading the laundry



- Turn off the water tap.
- Open the loading door.

If the loading door cannot be opened:
Wait for 2 minutes (the safety function is active)
or

there is still water in the washing machine if the “without” option was selected.

In this latter case, select the “Pumping” or “Spin” programme.

- Unload the laundry.

Caution

Remove any foreign objects (e.g. coins, paper clips) from the drum and rubber seal) – **risk of rust!**

- Leave the loading door open to allow the inside of the washing machine to dry out.

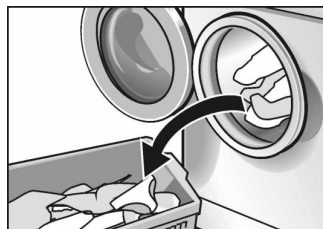

Special Applications

Pre-soak

- Load laundry of the same colour.
- Add the presoak agent to chamber **II** according to the manufacturer's specifications.
- Turn the programme selector to "30 °C Cottons/coloureds".
The "On" control light comes on.
- Press the "Start" button.
The "Active" control light comes on, and the programme starts.
- After approx. 10 minutes, turn the programme selector to "Off". The laundry is left to lie in the water.
- Select a programme after the desired soaking period.
- i** No additional detergent required, the soaking solution is used for washing.

Starching

- The laundry must not be treated with fabric softener.
- Load the laundry.
 - Dispense the correct amount of starch for approx. 15 litres / 3.3 gal. of water. Powdered starch must first be dissolved in water according to the manufacturer's specifications.
 - Turn the programme selector to "Rinsing".
 - Set the spin speed ("without **G**" is also possible).
 - Press the "Start" button.

As soon as water starts to enter the machine:

- Pull out the detergent dispenser slightly.
- Add the starching solution to chamber **I**.
- Close the detergent dispenser.

If the “without G” option is selected, the “Pumping” programme must subsequently be selected.

Dyeing

Only use dyes that are environmentally compatible and suitable for use in washing machines.

Caution

Discoloration of the laundry in subsequent wash cycles cannot be completely ruled out.

- Always use dyes in accordance with the manufacturer’s instructions.

After dyeing:

- Add ½ a measuring beaker of detergent to chamber **II**.
- Without any laundry in the drum, allow the “90 °C Cottons/coloureds” programme to run through.
- Wipe the seal clean.

Decolorizing

Caution

Decolorants may contain sulphur or chlorine. These substances can cause parts of the washing machine to corrode. Do not decolorize items of laundry in the washing machine.

Cleaning and Care

⚠ Risk of electric shock!

Always disconnect the appliance from the mains before cleaning.

Never clean the washing machine with a jet of water.

⚠ Risk of explosion!

Never use solvents to clean the appliance.

Cleaning the appliance housing and control panel

As required:

- Use hot soapy water or a mild, non-abrasive cleaning agent.
- Rub dry with a soft towel.

Cleaning the drum

In the event that rust spots have formed due to left-over debris (e.g. coins, paper clips, needles, nails):

- Use a chlorine-free cleaning agent. Follow the manufacturer's instructions. Never use steel wool.

Cleaning the detergent dispenser

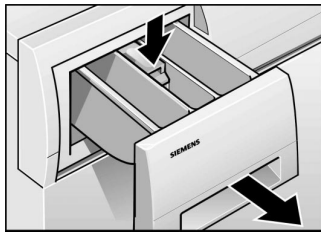

In the event that residual detergents or additives have accumulated:

- Pull out the detergent dispenser up to the end stop, press down the hollow on the insert and remove the detergent dispenser completely.

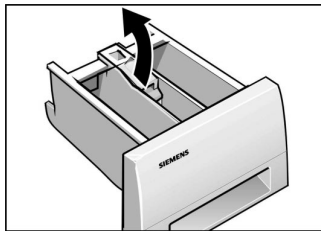

- Pull up the insert.
- Rinse the detergent dispenser under hot running water.

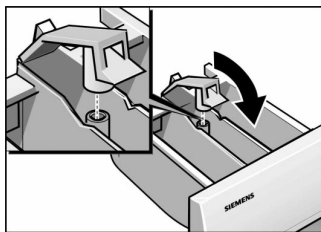

- Push down the insert until it clicks into place.
- Insert the detergent dispenser.

Cleaning the drain pump

Draining the washing solution

This is necessary if the washing solution cannot be completely drained. The pump is blocked by either loose debris or fluff which accumulates if fluff-giving fabrics are washed.

Up to 20 litres / 4.4 gal. Have a suitable container ready.

⚠ Risk of scalding!

Allow the hot washing solution to cool. Keep children and domestic pets away from the washing machine.

Turn the programme selector to "Off".

Fold down the cover panel.

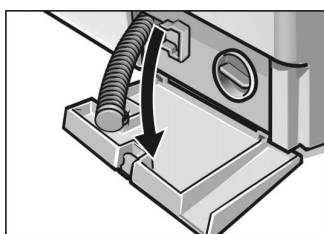
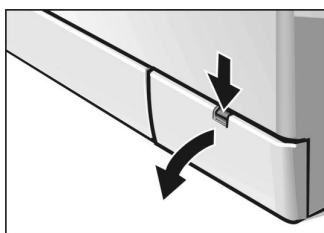

Remove the drain hose from its holder and pull the hose out of the housing.

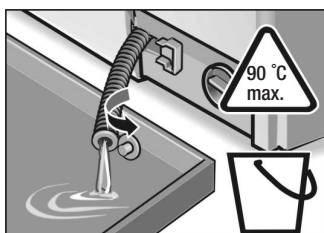

Pull down the closing cap and allow the washing lye to flow into a suitable container.

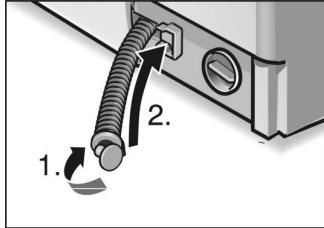

- Push up the closing cap (1st) and place the drain hose back in its holder (2nd).

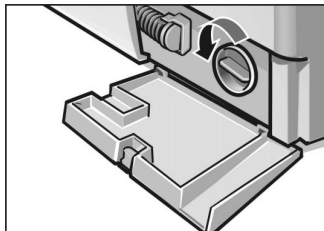

- Carefully remove the pump cap.
- Remove any loose debris / fluff from inside the pump and clean the pump. The pump impeller must be able to rotate. Clean any residual lye or fluff from the thread of the pump cap and pump housing.

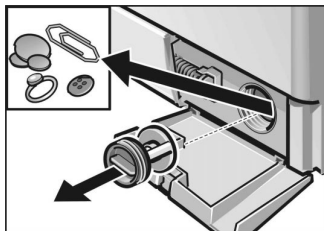

- Attach and tighten the pump cap.
- Attach and close the cover plate.

To avoid unused detergent from flowing into the drain during the next wash cycle:

- Pour 1 litre / 1 ¾ pt of water into chamber II.
- Select the “Pumping” programme.

Cleaning water inlet strainers

This is necessary if very little or no water flows into the washing machine.

First release the water pressure in the supply hoses:

- Turn off the water taps.
- Turn the programme selector to any programme (except “Spin 6” and “Pumping”).
- Press the “Start” button, and allow the programme to run for approx. 40 seconds.
- Turn the programme selector to “Off”.

Cleaning the strainer(s) at the water tap

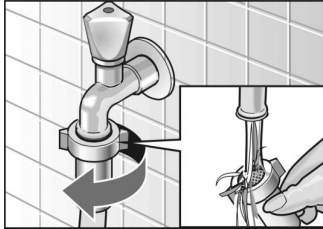

On both the hot and cold water tap:

- Disconnect the hose from the water tap.
- Rinse the strainer under flowing water.
- Reconnect the hose.

Cleaning the strainers on the washing machine

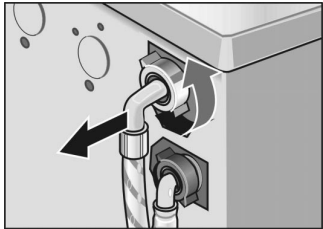

On both the hot and cold water tap:

- Disconnect the hose from the back of the washing machine.

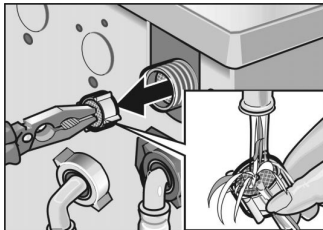

- Pull out the strainer and rinse under running water.
- Insert the strainer and reconnect the hose.
- Turn on the water tap and check whether water is still discharged. If water is still discharged, check that the strainer is attached properly.
- Turn off the water tap.

Descaling the washing machine

Caution

Descaling agents contain acids which can attack parts of the washing machine and discolour the laundry.

Provided that you use the correct amount of detergent, it is not necessary to descale the washing machine.

If, however, descaling the appliance becomes necessary, please follow the instructions provided by the descaling agent manufacturer.



Troubleshooting Minor Faults

⚠ Risk of electric shock!

Repairs must only be carried out by our Customer Service or an authorized technician.

If repairs are needed, and assuming that you cannot eliminate the fault yourself with the aid the following table:

- Turn the programme selector to "Off".
- Disconnect the washing machine from the mains.
- Turn off the water tap.
- Call Customer Service (refer to Page 34).

Fault	Cause	Action
The loading door cannot be opened.	"without  " was selected.	Select "Pumping" or "Spin  .
	Safety function is active.	Wait for 2 minutes.
Detergent residue in the detergent dispenser.	Detergent was damp or lumpy.	Clean and dry the detergent dispenser (refer to Page 27).
		Use the dispensing aid for liquid detergents.
Control lights do not come on.	A fuse has triggered.	Switch on / replace the fuse.
	Power failure.	Call Customer Service if this fault is repeated.
	Plug is loose or not inserted.	An interrupted programme will be resumed when power returns. If you wish to unload the laundry, proceed as in "Cleaning the drain pump", Page 28.
	Plug is loose or not inserted.	Insert the plug.

Fault	Cause	Action
Programme does not start. The "On" control light flashes.	Loading door not closed.	Check whether laundry is trapped in door. Close the loading door (a click should be heard).
	"Start" button not pressed.	Press the "Start" button.
Water does enter the machine or detergent is not washed away. The "Active" control light flashes.	Water tap not turned on.	Turn on water tap.
	Supply hose kinked or trapped.	Eliminate the cause.
	Strainer in supply hose clogged.	Clean the strainer (refer to Page 29).
Detergent in chamber I is not washed away.	A programme without Prewash was selected.	Select "60 °C Cottons/coloureds with Prewash".
Water cannot be seen in drum.	This is not a fault. The water lies below the visible part of the drum.	
Washing solution is not completely drained. The "End" control light flashes.	Loose debris is blocking the pump.	Clean the pump (refer to Page 28).
	Fluff-producing laundry was washed. The water drainage pipe or drain hose is blocked.	Clean the water drainage pipe and/or drain hose.
Water is flowing out from underneath the machine.	The thread of the supply hose is not tight.	Tighten the thread.
	Leak in the drain hose.	Replace the drain hose.
Foam coming out of the detergent dispenser.	Too much detergent.	Mix 1 tablespoon of fabric softener with ½ litre / 1 pt of water and pour into chamber I of the detergent dispenser.
		Reduce the amount of detergent next time.
The laundry was not spun	Large items of clothing became entangled and could not be distributed evenly in the drum. For safety reasons, the high-speed final spin cycle was automatically cancelled.	Always load large and small items together into the drum (see also unbalanced load detection system).

Fault	Cause	Action
Spin result unsatisfactory.	“Anticrease” button pressed – maximum spin speed 800 r.p.m.	
	“Rinsing” or “Spin  ” programme selected – maximum spin speed 800 r.p.m.	
Repeated spinning at short intervals.	This is not a fault. The imbalance compensation system is attempting to balance the load through repeated spins.	
The programme takes longer than usual.	This is not a fault. Unbalanced load detection system attempts to distribute the washing evenly by spinning it several times.	Always load large and small items together into the drum.
	The foam detection feature has activated an additional rinsing cycle to reduce the amount of foam.	Add a more appropriate amount of detergent next time.
Unsatisfactory washing result.	The degree of dirt was higher than supposed.	Select a more suitable programme.
	Not enough detergent.	Add detergent according to the manufacturer’s specifications.
Detergent residue on the laundry.	Some phosphate-free detergents contain water-insoluble residues that may appear as light spots on the laundry.	Select “Rinsing” immediately, or brush off spots when laundry is dry.
Grey residues on the laundry.	Dirt accumulation from ointments, fats or oils.	Add the maximum amount of detergent and select the highest permissible temperature next time.

Customer Service

Before calling the Customer Service, please make sure that you cannot eliminate the fault yourself (refer to Page 31).

This is because consultation provided by our technicians, even within the warranty period, will lead to costs being incurred by yourself.

Your nearest Customer Service centre can be found in the index supplied. When calling the Customer Service, please specify the product number (E-Nr.) and production number (FD-Nr.) of your appliance.

These numbers are shown on the rating plate which can be found on the frame of the open door and also on the identification plate, enclosed by a thick line, on the front of the machine behind the nameplate.

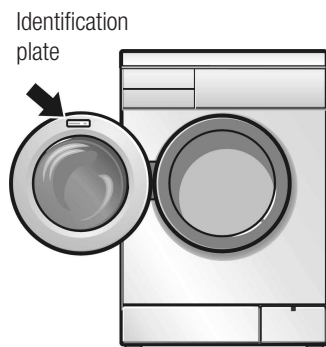

E-Nr. _____	FD _____
-------------	----------

Product number

Production number

Please note the two numbers in the space provided above.

In specifying the product number and production number of your appliance, you help us in our attempt to prevent unnecessary travelling and the associated extra costs.

Consumption Rates

Normal programme (without additional functions)	Load	Consumption rates **				Duration
		Electricity		Water		
		cold water	hot and cold water			
40 °C Cottons/coloureds	6.0 kg	0.6 kWh	0.2 kWh	51 l	118 min.	
	5.0 kg *	0.5 kWh	0.2 kWh	49 l	118 min.	
	2.0 kg	0.3 kWh	0.1 kWh	32 l	70 min.	
60 °C Cottons/coloureds	6.0 kg	1.15 kWh	0.4 kWh	51 l	118 min.	
	5.0 kg *	0.95 kWh	0.4 kWh	49 l	118 min.	
	2.0 kg	0.5 kWh	0.2 kWh	32 l	70 min.	
90 °C Cottons/coloureds (the hot washing solution is mixed with approx. 7 litres of cold water before being drained)	6.0 kg	2.2 kWh	1.1 kWh	58 l	118 min.	
	5.0 kg	1.9 kWh	1.0 kWh	56 l	118 min.	
	2.0 kg	1.2 kWh	0.5 kWh	39 l	85 min.	
40 °C Easy-care	2.5 kg *	0.4 kWh	0.2 kWh	50 l	75 min.	
30 °C Delicate	2.0 kg	0.3 kWh	0.3 kWh	50 l	55 min.	
30 °C Wool	2.0 kg *	0.3 kWh	0.3 kWh	35 l	50 min.	

* Test programmes in compliance with EN 60 456: 1999 and IEC 60 456 Ed.3 1998: 02

** The consumption rates may deviate from the stated values depending on water pressure and hardness, room temperature, type and amount of laundry, detergents used, fluctuations in the mains voltage and selected additional functions.

Installation, Connection and Transport

Safety information

⚠ Risk of injury!

The washing machine is heavy. Take care when lifting it.

Caution

Frozen hoses can tear / burst. Do not install the washing machine outdoors or in an area prone to frost.

Take care not to damage the washing machine. Do not hold onto protruding parts (e.g. loading door) when lifting.

In addition to the safety information listed here, the local water and electricity supplier may have special requirements.

If in any doubt, have the appliance connected by an authorized technician.

Factory-supplied equipment

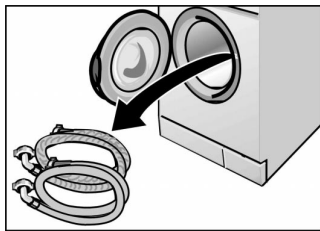

Inside the drum:

- Water supply hoses.

Any dampness inside the drum is left over from final testing which every washing machine is subjected to before leaving the factory.

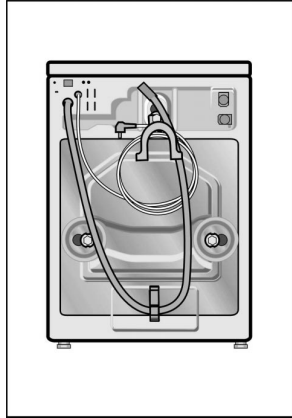

On the back of the machine:the back of the machine:

- Water drain hose.
- Mains cable with plug.
- Elbow for attaching the drain hose, e.g. into a wash basin.

Depending on the type of connection, the following may also be required:

- Y-piece (can be obtained from any specialist store) in the event that cold water connection only is possible.
- 1 hose band clip of 24-40 mm dia. (from specialist store) for connection to a siphon.

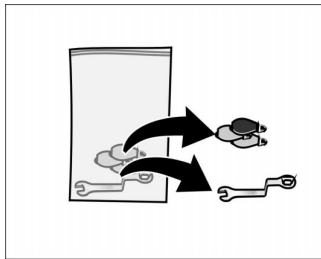

The bag contains:

- Wrench
- Covers for placing over the openings after the transport bolts have been removed.

Useful tools

The following tools are helpful:

- Ring wrench (SW 13).
- Spirit level.

Dimensions

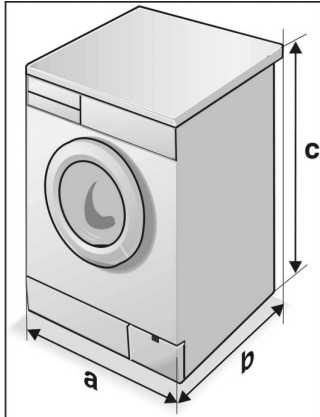

a = 600 mm

b = 590 mm

c = 852 mm

Approx. weight = 69 kg

Installation area

Appliance stability is important so that the washing machine does not “wander” during the spin cycles.

The installation area must be solid and even. Soft floor surfaces, such as carpets or surfaces with foam backing, are not suitable.

If the washing machine is to be installed on a wood joist ceiling:

- If possible, place the washing machine in a corner of the room.
- Screw a water-resistant wooden board (at least 30 mm thick) to the floor.
- Affix the feet of the washing machine using holding brackets *.

If the washing machine is to be placed on a pedestal:

- Affix the feet of the washing machine using holding brackets *.

* Holding brackets (set) can be obtained from a specialist store or the Customer Service (order no. WX 9756).

Removing the transport bolts

Preparing

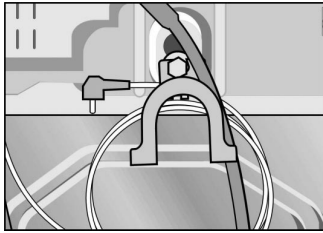

Removing

Caution

The transport bolts must always be removed before using the appliance for the first time and must be retained for any subsequent transport (e.g. when moving).

Before removing the transport bolts:

- Take the hoses out of the holders.
- Detach the elbow.

- Release screws **1**, **2** and **3** using the SW 13 wrench until they can be moved freely.
- Completely remove transport bolts **1** and **2** (bolts, washers and bushes).
- Completely remove transport bolt **3** (bolt, spring, washer and bush) by reaching through the open washing machine door and pulling the drum forwards slightly.

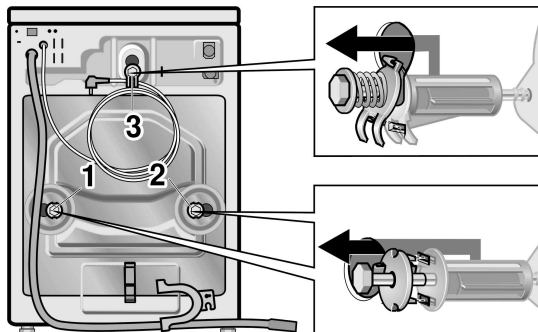

- Insert the covers.

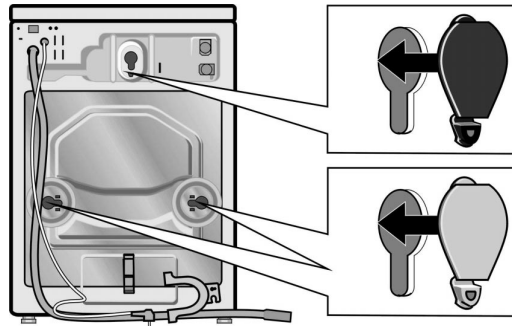

Storing the transport bolts

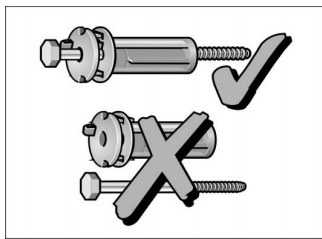

Always keep the transport bolts for subsequent transportation of the appliance (e.g. when moving house).

- Store the transport bolts **1** and **2** with washer and bush attached.

Hose and cable lengths

Left-hand connection

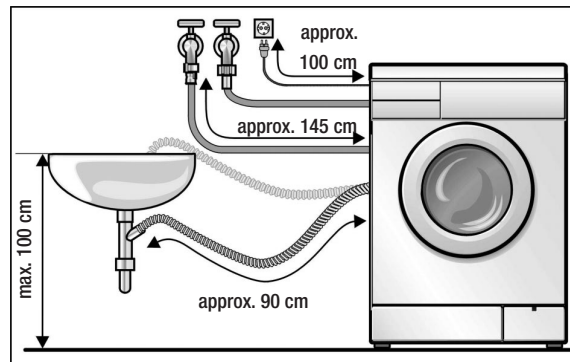

Right-hand connection

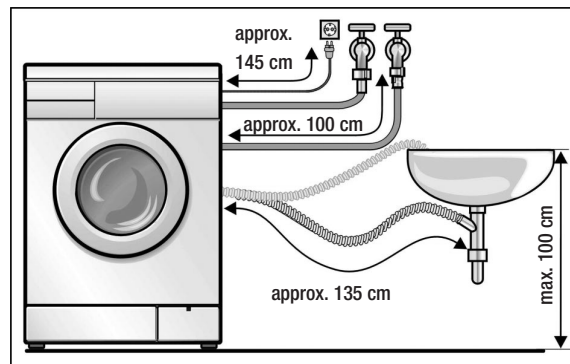

Other hoses

Available from specialist dealers:

- Extended supply hose (approx. 2.2 m).

Water connection

Water supply

Caution

The washing machine must only be operated with cold and hot (max. 70 °C) tap water. Do not connect the appliance to the mixer tap of an unpressurized hot-water boiler.

If in any doubt, have the water connection carried out by an authorized technician.

The water supply hoses must not be:

- Bent or squashed.
- Modified or cut through (stability can no longer be guaranteed).

Plastic threads must only be tightened by hand. Do not remove the strainers from the water supply hoses.

Observe the water pressure in the supply network:

- The water pressure should be between 1 and 10 bars (when the tap is turned on, at least 8 litres of water is discharged per minute).
- A pressure reducing valve must be installed if the maximum water pressure is exceeded.

Connection options

- A** Cold water connection and
- B** Hot water connection (max. 70 °C)

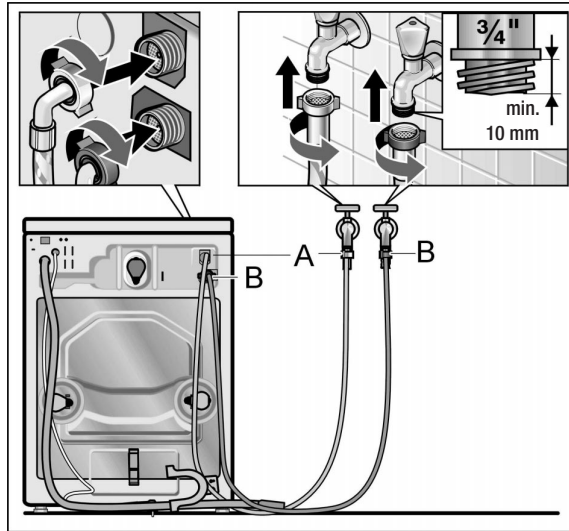

- or
- Cold water connection only with Y-piece**

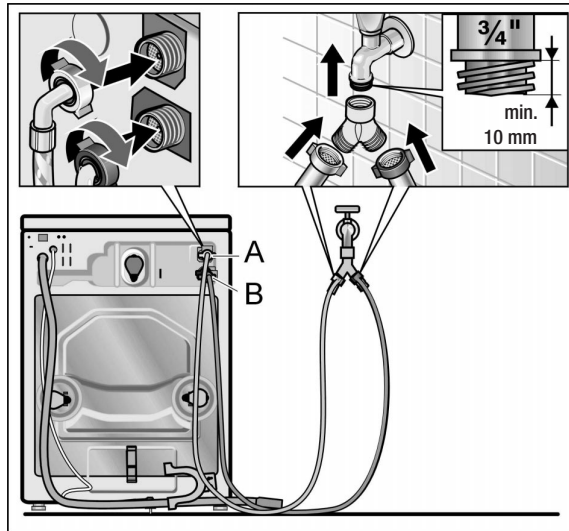

- Subsequent to connection:
Turn on the water taps completely, and check connection points for water-tightness.

Water drainage

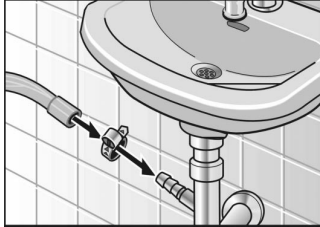

Caution

Do not bend or pull the water drainage hose.

Height difference between the placement area and drainage point: Maximum 100 cm.

Drainage into a siphon:

- Secure the connection point with a hose band clip of 24-40 mm dia. (from specialist store).

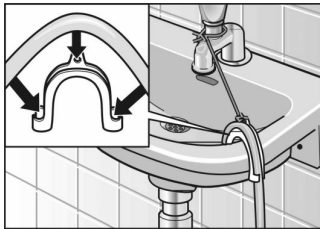

Drainage into a wash basin:

Caution

The plug must not block the drain of the wash basin.

- Secure the water drainage hose so that it does not slide out.
- When water is being drained, check that the water flow is fast enough.

Levelling procedure

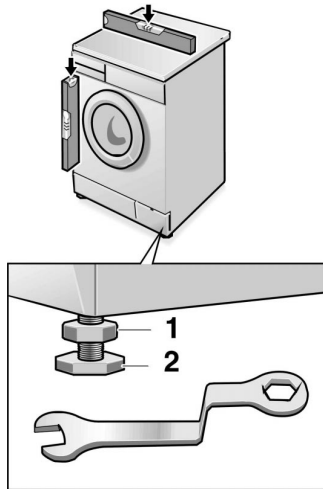

All four appliance feet must be firmly on the ground.
The washing machine must not wobble.

Level the washing machine with the assistance of the four adjustable feet and a spirit level:

- Loosen the counter-nut **1** using the wrench.
- Adjust the height by means of turning the appliance foot **2**.
- Tighten lock nut **1** against the housing.

Electrical connection

Caution

The washing machine must only be connected to alternating current and using a properly installed socket outlet with earthing contact.

The mains voltage must correspond to the voltage specification on the washing machine (nameplate). Connection specifications as well as the required fuses are stipulated on the appliance nameplate.

Make sure that:

- the mains plug fits the socket outlet.
- the cable cross-section is permissible.
- the earthing system is properly installed.

The mains cable may be replaced by an electrician only.

Replacement mains cable available from customer service.

Do not use multiple plugs / connectors or extension cables.

In the event that an earth-leakage circuit breaker is to be used, only use types marked with the following symbol: . Only this symbol can guarantee compliance with all current regulations.

Do not insert / remove the mains plug with wet or damp hands.

Handle the plug body only when removing the plug from the socket.

Transport, e.g. when moving

Before transporting the washing machine:

- Turn off the water tap(s),
- Drain any residual washing solution (refer to Page 28).
- Release the water pressure in the supply hose(s) (refer to Page 29),
- Disconnect the washing machine from the mains.
- Dismantle the supply and drainage hoses,
- Install the lower 2 transport bolts.

Having transported the appliance and ensured proper installation and connection, allow the "Pumping" programme to run through before starting the first wash programme.

Preparing and inserting the transport bolts

- Remove the 2 lower covers.
- Prepare the transport bolts:
Loosen the screw in the sleeve until the end of the screw is level with the end of the sleeve.
- Insert and tighten transport bolts **1** and **2**. The lug on the washer must be located in the groove in the rear panel of the housing.

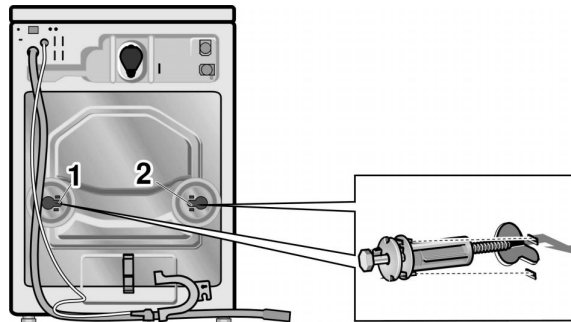

SIEMENS ELECTROGERÄTE GMBH

0101 en
5500 007 029