

**AUTOMATIC DRUM WASHING MACHINE**

**USER MANUAL**

TKW 1070



03 - 09

10 - 15

16- 20

**TABLE OF CONTENTS****BEFORE USE**

>COMPONENTS .....	03
>PREPARATION .....	04
>SAFETY INSTRUCTIONS .....	05
>INSTALLATION.....	06
>CONTROL PANEL .....	08

**USING THE APPLIANCE**

>PROGRAM SELECTION.....	10
>CONSUMPTION AND TECHNICAL DATA ..	11
>WASHING METHODS .....	12
>CLEANING & CARE.....	16

**MAINTENANCE**

>DISPLAY CODES .....	18
>TROUBLESHOOTING.....	19
>WIRING CIRCUIT.....	20

**LEGEND**

Yes



No



Optional



For your safety, any instructions in this manual with this "Warning" sign must be followed strictly.

**DISPOSAL**

As a responsible retailer we care about the environment. As such we urge you to follow the correct disposal procedure for your product and packaging materials.

This will help conserve natural resources and ensure that it is recycled in a manner that protects health and the environment.

You must dispose of this product and its packaging according to local laws and regulations. Because this product contains electronic components, the product and its accessories must be disposed of separately from household waste when the product reaches its end of life.

Contact your local authority to learn about disposal and recycling. The product and packaging should be taken to your local collection point for recycling. Some collection points accept products free of charge.

We apologize for any inconvenience caused by minor inconsistencies in these instructions, which may occur as a result of product improvement and development.

**COMPONENTS****THANKS FOR PURCHASING A TEKA PRODUCT**

Please read these instructions carefully before using this appliance. The instructions contain important information which will help you get the best out of the appliance and ensure safe and proper installation, use and maintenance.

Keep this manual in a convenient place so you can always refer to it for the safe and proper use of the appliance.

If you sell the appliance, give it away, or leave it behind when you move house, make sure you also pass on this manual so that the new owner can become familiar with the appliance and safety warnings.

**ACCESSORIES**

Check the accessories and literature

in accordance with this list:

1x Inlet hose assembly

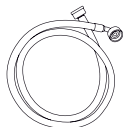

1x Drain hose bracket

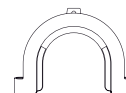

1x User manual



4x Blanking plugs



1x Warranty card



# 04 BEFORE USE

## PREPARATION

### PREPARING THE MACHINE

Remove all the packing materials to prevent unsteadiness, including the polystyrene base. Upon opening the package, water drops may be seen on the plastic bag and the porthole. This is normal phenomenon resulting from water tests in the factory.

### DESCRIPTION

This diagram may be slightly different from the layout of the washing machine you have just purchased due to technical improvements.

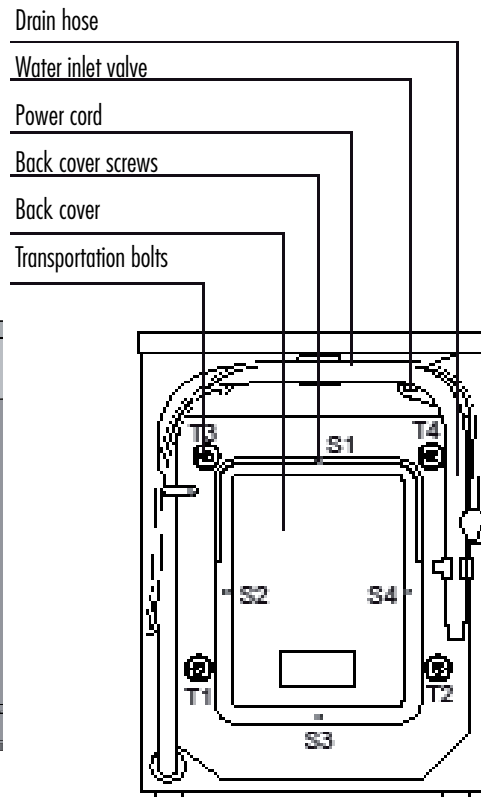
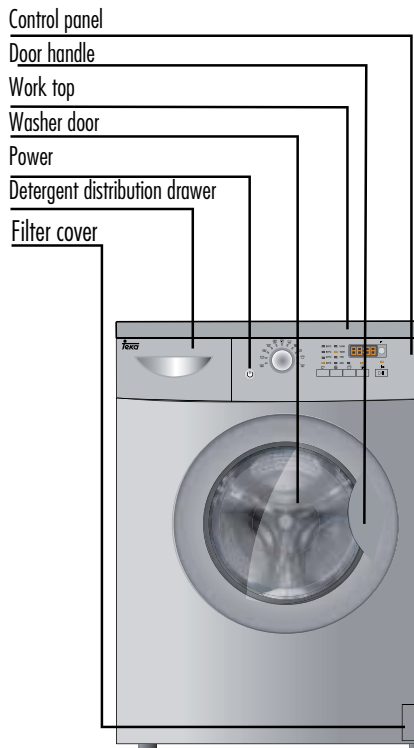
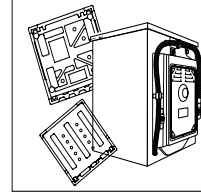

**SAFETY INSTRUCTIONS****BEFORE SWITCHING THE APPLIANCE ON FOR THE FIRST TIME****DO ...**

- ... Make sure that the transport bolt are removed.
- ... Use a separate earthed socket for the power supply.
- ... Make sure that the plug is accessible.
- ... Hold the plug and not the electric cable when unplugging the power supply.
- ... Make sure that the fuses in the power circuit are rated for 15A.
- ... Keep away from heat sources and direct sun light to prevent plastic and rubber components from aging.
- ... Make sure that the power cord is not caught under or in the appliance and avoid damage to the power cable.
- ... Check that hose joints and connections are firm and no water can leak. If joints are loose or there is leakage, turn off the water supply and refix. Do not use the washing machine until the hoses are properly fixed.

**DURING DAILY USE OF THE APPLIANCE****DO ...**

- ... Pull up zips and fix loose threads to prevent the items from being entangled. If necessary, put small items into a net bag or pillow.
- ... Turn off the machine after each wash program and switch it off at the mains to save electricity and for safety. Wipe clean the lower part of the porthole.
- ... Keep the door slightly open when the washing machine is not in use to prevent formation of odours.
- ... Let the power cord be replaced by the manufacturer, his service agent or other accordingly qualified persons, in case it is damaged.
- ... Ensure that the appliance is not used by persons with reduced physical, sensory or mental capabilities, lack of experience and knowledge without supervision or instruction by a person responsible for their safety.
- ... Supervise children to ensure that they do not play with the appliance.

**DO NOT ...**

- ... Touch or use the appliance when barefoot or with wet or damp hands or feet.
- ... Use flammable detergent or dry cleaning agent.
- ... Use any flammable sprays in close vicinity to the appliance.
- ... Remove or insert the plug in the presence of flammable gas.
- ... Allow children or infirm persons to play with the appliance or packing materials.
- ... Install the appliance outdoors in a damp place, or in an area which may be prone to water leaks such as under or near a sink unit. In the event of a water leak allow the machine to dry naturally.
- ... Place the washing machine directly on a carpet, or close to a wall or furniture.

**DO NOT ...**

- ... Touch the washer door during the washing process - it gets hot!
- ... Place heavy objects or sources of heat or damp on top of the appliance.
- ... Hot wash foam rubber or sponge-like materials.
- ... Open the detergent distribution drawer during the wash cycle.
- ... Force the washer door open. The door is fitted with a self-lock device and will open shortly after the washing procedure is ended.
- ... Open the washer door if the water level is visibly over the porthole.
- ... Cover the washing machine with plastic cover so that inside dampness cannot be kept in.

**INSTALLATION****DISMANTLE THE TRANSPORTATION BOLTS**

The transportation bolts are designed for clamping anti-vibration components inside of the washing machine during the transportation process.

1. Remove the back cover.
2. Remove the four bolts on the rear side and take out the synthetic stabilisers from within the machine.
3. Replace the back cover.
4. Fill the holes left by the bolts with blanking plugs.

**Note:**

**1. When you replace the back cover, the convexity must face to outside, and you have to insert the back cover from the two gaps as shown in fig.5.**

**2. Keep the transportation bolts and synthetic stabilisers in a safe place for later use.**

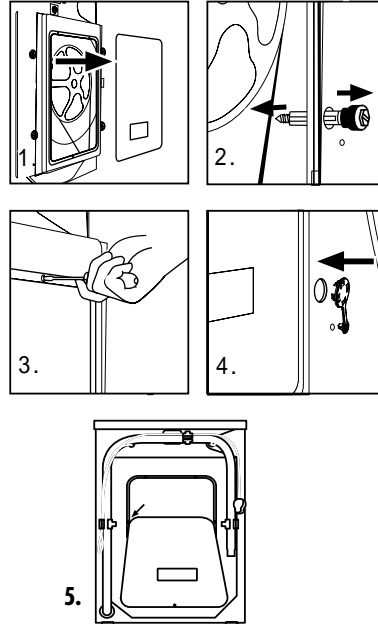
**ADJUSTING THE WASHING MACHINE**

There are adjustable feet under the bottom of the washing machine. Before use, they should be adjusted so that the machine is level. This will minimise vibrations and thus noise during use. It will also reduce wear and tear. We recommend using a spirit level to level the appliance. The floor should be as stable and flat as possible.

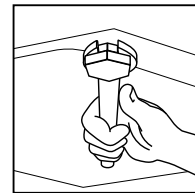

**INLET HOSE**

1. Connect the nut on the inlet hose to the connector on the water valve.
2. Apply inlet hose to a water tap with cold, fresh water.

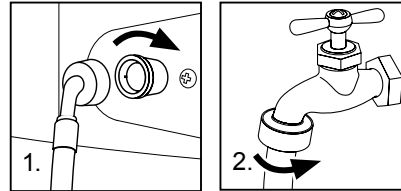

**Note: Use the hose-set supplied with the appliance. Old hose-sets should not be reused.**

**DRAIN HOSE**

1. Use the drain hose bracket to keep the end of the drain hose retained and prevent the outflow of water. Don't extend the length of the drain hose; if an extended hose is required, please consult a serviceman.
2. The height of the drainage outlet must be 80-100 cm. Fix the drain hose to the clip at the back of the washing machine to prevent it from dropping off.

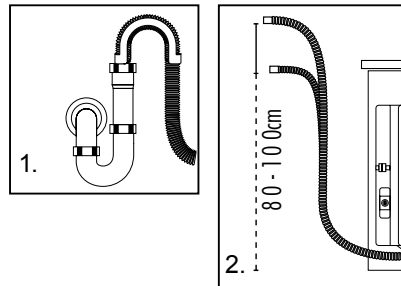

**Note: The drain hose should not be submerged in water and should be securely fixed and leak-free. If the drain hose is placed on the ground or if the pipe is at a height of less than 80cm, the washing machine will continuously drain while being filled (self-siphoning).**

**CONNECTING TO THE POWER SUPPLY**

Before connecting to the power supply, check:

- The socket is adequate for the maximum power of the washing machine (For safety, fuses in the power circuit should be rated for no less than 15A).
- The voltage should meet the requirement.
- The power outlet should be capable of accepting the washing machine plug.
- Connect the machine to an earthed socket outlet.

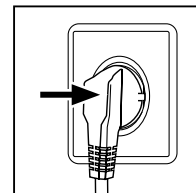

# 08 BEFORE USE

## CONTROL PANEL

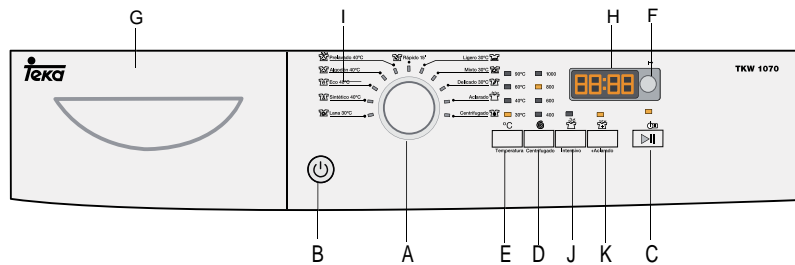

- |          |                               |          |                               |
|----------|-------------------------------|----------|-------------------------------|
| <b>A</b> | Program knob                  | <b>G</b> | Detergent distribution drawer |
| <b>B</b> | Power Switch                  | <b>H</b> | Display                       |
| <b>C</b> | Start/Pause button            | <b>I</b> | ECO                           |
| <b>D</b> | Spinning Speed Setting button | <b>J</b> | Intense button                |
| <b>E</b> | Washing temperature button    | <b>K</b> | Extra rinse button            |
| <b>F</b> | Delay Button                  |          |                               |

### OPERATIONAL FUNCTIONS

- |          |                                 |  |
|----------|---------------------------------|--|
| <b>A</b> | → Program knob                  | By turning the knob clockwise/counterclockwise, the required program can be selected. There are 11 programs available. After a program is selected, the corresponding light will go on.  |
| <b>B</b> | → Power Switch                  | Press this button to switch on the washing machine. Press it again to switch it off. Press On/Off button gently for 2 seconds to switch off the machine as buttons are soft touch sensitive.   |
| <b>C</b> | → Start/Pause Button            | When the washing machine is connected to the power socket and a program is selected, lightly touch this button to start operation. During a wash cycle, touch it lightly, operation will stop and the digits on the screen start blinking. Touch it again to resume operation. To cancel a wash program during a wash cycle, touch this button, when the digits on the screen start blinking, press the Power switch, the program will be cancelled. |
| <b>D</b> | → Spinning Speed Setting Button | Touch this button lightly to select the desired speed. When a speed is set, it will be displayed on the indicator. Note: If there is no indicator light displayed, it means no spinning.<br><b>Note: Different water temperatures and spinning speeds can be set for different laundries. Wash using the default settings if there is no special requirement.</b>  |
| <b>E</b> | → Washing temperature button    | Touch this button lightly, the washing temperature will be displayed on the indicator. Select a temperature according to the type of laundry. Note: If there is no indicator light displayed, it means cold wash.  |

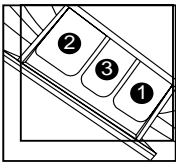

F	-Delay Button	<p>Touch this button lightly, the washing machine will start operation after a period of time and the corresponding indicator will go on. The range is 0.5-24 hours; each touch of this button increases a half hour. After the button is set, press the Start/Pause button to start countdown of the set time (the time is displayed on the screen until the program ends).</p> <p><b>Note: The delay time must be longer than the program time; otherwise, the washing machine will start the wash program directly.</b></p>
G	- Detergent distribution drawer	<p>_Open the drawer, three compartments can be seen:</p> <p>Compartment 1: Prewash detergent          Compartment 2: Detergent for programs 1 to 10.          Compartment 3: Softener, conditioning agent, perfume, etc.</p> 
H	-Display	<p>_Information as remaining wash time and error messages will be shown here.</p> <p><b>Note: After power is switched on, the display will go on and the remaining wash time decreases. As the water pressure and temperature may differ, the remaining time maybe adjusted accordingly. When the laundry is not balanced during spinning, the time may be automatically prolonged. These are normal phenomena.</b></p>
I	Eco	<p>Before a washing program, select this program to set the washing load (1/2 Full), the washing machine will automatically adjust the water consumption and washing time.</p>
J	Intense button	<p>If the laundry is heavily soiled, press this button before starting the program. When the button is pressed, the washing time increases.</p>
K	Extra rinse button	<p>Press this button, the washing machine will perform additional rinses. Press the button once to select one additional rinse. The display will show "P-1". Press the button repeatedly and the screen will display "P-2" or "P-3", indicating two or three additional selected rinses. The "extra rinse light" is activated and flashes during the performance. "P-1/2/3" is displayed alternating with the remaining time. The light turns off and the display disappears when the extra rinse ends.</p> <p><b>Note: Select this function when program 1-9 is selected.</b></p>

## PROGRAM SELECTION

## PROGRAM MODES

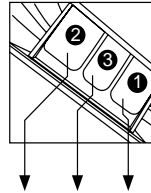

- 1 Detergent compartment for prewash mode
- 2 Detergent compartment
- 3 Compartment for softener and other additives

Program	Temperature	Maximum	Preset	Detergent compartments			Recommended Laundry	TKW 1070
				2	3	1		
1  Lana 30°C	-- to 40 °C	30°C	<input checked="" type="checkbox"/>	<input type="checkbox"/>	<input type="checkbox"/>	Woolen fabrics	400 rpm	
2  Sintético 40°C	-- to 60 °C	40°C	<input checked="" type="checkbox"/>	<input type="checkbox"/>	<input type="checkbox"/>	Fast colour synthetic	1000 rpm	
3  Eco 40°C	-- to 90 °C	40°C	<input checked="" type="checkbox"/>	<input type="checkbox"/>	<input type="checkbox"/>	Cotton fabrics	1000 rpm	
4  Algodón 40°C	-- to 90 °C	40°C	<input checked="" type="checkbox"/>	<input type="checkbox"/>	<input type="checkbox"/>	Cotton fabrics	1000rpm	
5  Prelavado 40°C	-- to 90 °C	40°C	<input checked="" type="checkbox"/>	<input type="checkbox"/>	<input type="checkbox"/>	Heavy soiling	1000rpm	
6  Rápido 15'	-- to 30 °C	30°C	<input checked="" type="checkbox"/>	<input type="checkbox"/>	<input type="checkbox"/>	Slight-soil cotton, linen and synthetic fabrics	800rpm	
7  Ligero 30°C	-- to 30 °C	30°C	<input checked="" type="checkbox"/>	<input type="checkbox"/>	<input type="checkbox"/>	Sports wear	1000 rpm	
8  Mixto 30°C	-- to 60 °C	40°C	<input checked="" type="checkbox"/>	<input type="checkbox"/>	<input type="checkbox"/>	Different materials	1000 rpm	
9  Delicado 30°C	-- to 40 °C	30°C	<input checked="" type="checkbox"/>	<input type="checkbox"/>	<input type="checkbox"/>	Cotton or synthetic	1000 rpm	
10  Aclarado	--	--	<input type="checkbox"/>	<input type="checkbox"/>	<input checked="" type="checkbox"/>	/	1000 rpm	
11  Centrifugado	--	--	<input checked="" type="checkbox"/>	<input checked="" type="checkbox"/>	<input checked="" type="checkbox"/>	/	1000rpm	

Yes     No     Optional









# USING THE APPLIANCE

## CONSUMPTION AND TECHNICAL DATA

11

### CONSUMPTION TABLE

The wash cycle times are intended as a guide only. The actual time used may vary due to different water pressure, initial water temperature, etc.

PROGRAM	MAX. LOAD	ENERGY CONSUMPTION	WATER CONSUMPTION	TEMPERATURE	WASHING TIME
 Lana 30°C	2 kg	0.34 kWh	55L	30°C	1:00 h
 Sintético 40°C	4 kg	0.71 kWh	50L	40°C	1:10 h
 Eco 40°C	4 kg	0.78 kWh	44L	40°C	1:18 h
 Algodón 40°C	7/8 kg	0.83 kWh	46.5L	40°C	1:38 h
 Prelavado 40°C	7/8 kg	1.08 kWh	68L	40°C	1:46 h
 Rápido 15'	4 kg	0.11 kWh	25L	30°C	0:15 h
 Ligero 30°C	4 kg	0.34 kWh	30L	30°C	0:25 h
 Mixto 30°C	7/8 kg	0.78 kWh	50L	40°C	1:15 h
 Delicado 30°C	4 kg	0.3 kWh	50L	30°C	1:01 h

**\*) EN 60456 test program / Energy label program with Standard 60°C and max. spin speed and Intense function.**

### TECHNICAL DATA

	TKW 1070
Power source	220 - 240V~/50Hz
Max. working current (A)	10
Water pressure (MPa)	0.03 ≤ P ≤ 1
Nominal load (kg)	7
Spinning speed (r/min)	1000
Washing programs	11
Max power (W)	2000
Dimensions (HxDxW mm)	850 x 600 x 595
Net weight (kg)	70

**WASHING METHODS**

This washing machine is for domestic use only. If the machine is used for commercial purpose the guarantee will not be valid anymore. Do not use it for purposes other than that for which it was designed. Follow the instructions given on the label of each garment and wash only machine-washable garments.

**POWER SUPPLY**

Connect the washing machine to the power supply (220V to 240V~/50Hz).

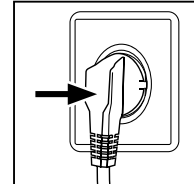
**WATER CONNECTION**

Turn on the tap. The water must be clean and clear.

**Note: Before use, check for leakage in the joints between the tap and the inlet hose by turning on the tap.**

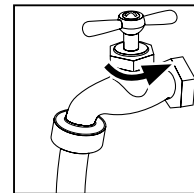
**PREPARING THE LAUNDRY**

- Sort out clothes according to fabric (cotton, synthetics, wool or silk) and to how dirty they are.
- Separate white clothes from coloured ones. Wash them first by hand to check if they fade or run.
- Empty pockets (keys, coins, etc.) and remove the harder decorative objects (e.g. brooches).

**Attention: Small parts (like buttons, etc) may lead to repair work which user has to pay by themselves and can cause damage in the machine.**

- Garments without hems, underwear, finely woven textile such as fine curtains are to be put into wash bag (it is better not to wash them in a washing machine).
- Close zippers and hooks, make sure the buttons are sewn on tightly and place small items such as socks, belts, bras, etc. in the wash bag.
- Unfold large pieces of fabric such as bed sheets, bedspreads, etc.
- Turn shirts inside out.

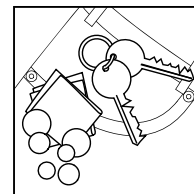
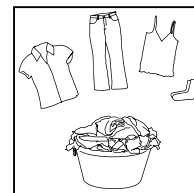

## **LOADING THE MACHINE**

Open the washer door, put in the laundry piece by piece. Close the door tightly.

→ When first using the washing machine, let it run unloaded for one program to prevent the laundry from being tainted by oil or dirty water from the washing machine. Before washing you should run the machine without laundry, but with detergent, with 60°C program.

→ Do not overload the washing machine.

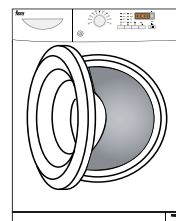

## **SELECTING DETERGENT**

The washing efficiency and the performance is determined by the quality of detergent used. Special non-foaming detergent produces good washing results. Use specific detergents for synthetic and woollen goods. Do not use dry cleaning agents such as trichloroethylene and similar products.

Note: Do not add more detergent than needed; otherwise, it may cause the situations as following and washing machine malfunction impacting washing machine's life.

1. Due to the increasing foam, the rinse time will be longer than normal;
2. The foam may overflow from the detergent drawer because of the increasing pressure of the foam;
3. It may remain foam without cleaning out after the final spinning cycle.

Recommendation:

1. Clean the detergent drawer once a week.
2. When using the prewashing program, please add half of the rating dosage.
3. Please follow the dosage recommendation on the powder or liquid detergent package.

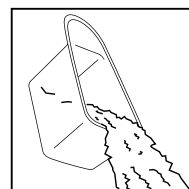

## **ADDING DETERGENT**

Slide out the detergent drawer and put the required detergent and softening agent into the corresponding compartments. Push back the drawer gently. (Refer to the instructions on the drawer)

### **Caution:**

- For prewashing program, detergent should be added to both compartments 1 and 2.
- For other programs, do not add detergent to compartment 1.**
- Use liquid detergent according to the instructions on its package. Do not use liquid detergent if the prewash mode or "Start delay" is selected.
- Do not overuse softener; otherwise, it will damage the artificial fibers.

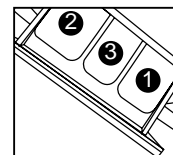

## **SELECTING PROGRAM**

To get the best washing results, an appropriate washing program should be selected according to the laundry type. Please turn the program knob to select the right program.

## **SELECTING FUNCTIONAL**

Select the required options. (Refer to the "Control panel" pages 08 and 09)

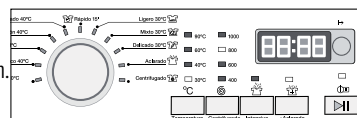

**SETTING WASHING TEMPERATURE**

Press and hold down the temperature button until the desired temperature is selected.

**SETTING SPIN SPEED**

Press and hold down the speed button until the desired speed is selected. See "Operational functions" on the "Control panel" pages (08 and 09) for selecting temperature and spin speed. It is advisable to select the recommended value.

**WASHING**

Press the Start/Pause button. The washing machine will operate according to the preset programs. The washing machine will stop operation automatically when a washing cycle ends. The "End" sign will appear on the display. Open the washer door and take out the laundry.

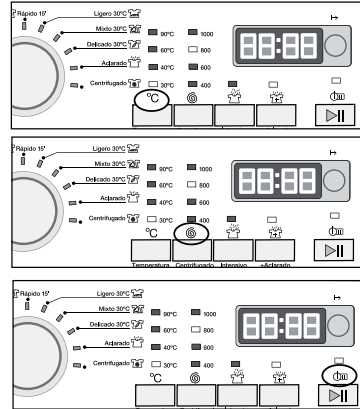



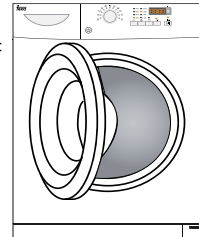























**AFTER WASHING**

Turn off the water supply and unplug the power cord. Open the washer door to prevent formation of moisture and odours. Let the door open while not used.

**TIPS FOR SAVING ENERGY**

1. Collect clothes for one full wash load.
2. Avoid overloading the washing machine.
3. Prewash only heavily soiled clothes.
4. Reduce the amount of detergent or choose standard or delicate wash programs for slightly soiled clothes.
5. Choose a proper washing temperature. Modern detergents can wash with very good result already in lower temperature than 60°C. Only use higher temperature than 60°C for heavily soiled laundry.
6. Follow the dosage recommendation on the detergent package to avoid using too much detergent.

## CARE CHART

	Resistant material		Bleachable in cold water		Don't dry clean	
	Delicate fabric		Do not bleach		Dry flat	
		Washable at 95 °C		Iron at 200 °C		Hung to dry
		Washable at 60 °C		Iron at 150 °C		Dry on clothes hanger
		Washable at 40 °C		Iron at 100 °C		Tumble dry, normal heat
		Washable at 30 °C		Don't iron		Tumble dry, reduced heat
	Hand wash		Dry cleaning with any solvent		Don't tumble dry	
	Dry clean only		Dry cleaning with perchloride			
	Wool Seal		Dry cleaning with aviation fuel			

## LOAD REFERENCE

Bed sheet (single)	Cotton	Approximately 800g
Blanket	Wool	Approximately 3000g
Blended fabric clothes	/	Approximately 800g
Jackets	Cotton	Approximately 800g
Jeans	/	Approximately 800g
Overalls	Cotton	Approximately 950g
Ladies Pyjamas	/	Approximately 200g
Shirts	/	Approximately 300g
Socks	Blended fabrics	Approximately 50g
T-Shirts	Cotton	Approximately 300g
Underwear	Blended fabrics	Approximately 70g

**CLEANING & CARE****AFTER WASHING**

Turn off the water supply and pull out electricity plug after each wash. Open the washer door to prevent formation of moisture and odours. If the washing machine is left idle for a long period, drain the water in the machine and replace the drain hose.

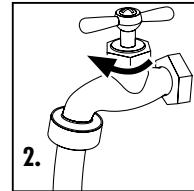
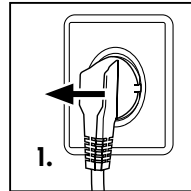
**CLEANING THE DETERGENT DRAWER**

Clean the detergent distribution drawer regularly.

Swing out the drawer, flush it clean with water and then replace it.

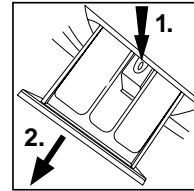
**CLEANING THE MACHINE**

Unplug the machine during cleaning and maintenance. Use a soft cloth dampened with soap liquid to clean the machine case and rubber components. Do not use organic chemicals or corrosive solvents.

**CLEANING THE FILTER**

Clean the filter once a month:

1. Open the bottom cover.
2. Remove the filter by turning counterclockwise.
3. Flush the filter clean with running water.
4. Replace the filter by turning clockwise and remount the cover.

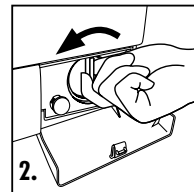
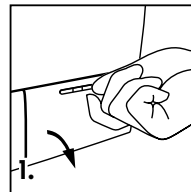
**Caution:**

**1. The filter must be in place, or it may lead to leakage.**

**2. Place a container under the drain pump filter, to collect any excess water that may come out of the drain pump when the filter is removed.**

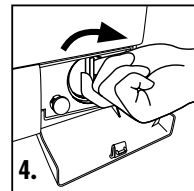
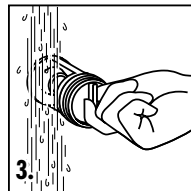



## **WATER INLET VALVE AND INLET VALVE FILTER**

To prevent blockage to the water supply by ingress of foreign substances, clean the water inlet valve and inlet valve filter regularly.

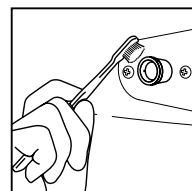

## **MOVING THE MACHINE**

If the machine is to be moved to a distant location, replace the transportation bolts removed before installation to prevent damage as shown below.

1. Remove the blanking plugs.
2. Remove the back cover
3. Insert the synthetic stabilisers and the transportation bolts.
4. Tighten the bolts with a spanner.
5. Replace the back cover.

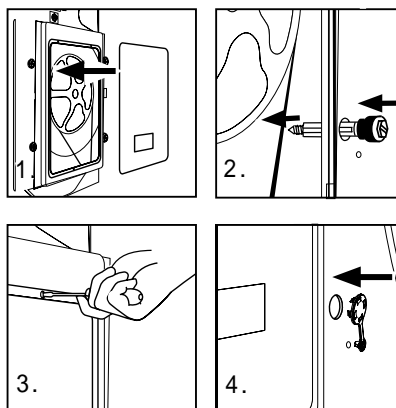

## **LONG PERIODS OF DISUSE**

If the washing machine is left idle for a long period, pull out the electrical plug and turn off the water supply. Open the washer door to prevent formation of moisture and odours. Let the door open while not used.

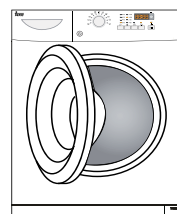

**DISPLAY CODES****DISPLAY CODES AND SPECIAL FUNCTIONS**

CODES	CAUSES	SOLUTIONS
Err1	→ Door is not properly shut.	_ Shut the door properly.
Err2	→ Drainage error, water not emptied within 6 minutes.	_ Clean the filter and check the drain hose for blockage. If error still exists, please contact the maintenance personnel.
Err3	→ Temperature sensor not properly connected or damaged.	_ Contact the maintenance personnel.
Err4	→ Heater error (Appears at the end of a cycle).	_ Contact the maintenance personnel.
Err5	→Water level not met in 8 minutes.	_ Make sure that tap is turned on, and water pressure is normal. If problem still exists, please contact the maintenance personnel.
	→The height of the drain hose is below 80 cm.	_ Install drain hose within 80-100 cm of height.
	→ The drain hose is in water.	_ Make sure the drain hose is not in water.
Err7	→ Motor error.	_ Contact the maintenance personnel.
Err8	→ Water exceeds protective level.	_ Contact the maintenance personnel.
End	→ End of wash cycle.	
1:25	→The remaining time is 1 hour 25 minutes.	
19:30	→Status information:Preset time for delayed operation.	
UNb	After the last rinsing cycle finishes,spinning fails completely due to unbalance of the laundry.	

→ Control panel lock function: Press the "Delay" and the "Start/Pause" buttons simultaneously for 3 seconds after starting a program. It can no longer be changed by operating buttons or knobs. To unlock press the "Delay" and "Start/Pause" buttons again for 3 seconds.

→ Power-off memory function: In case of abrupt power failure or the need to cut off the power during a program cycle, the present settings will be saved and the preset operation will resume when the power is on again.

→ To cancel a program

Press the "Start/Pause" button, then switch off the power and the program is automatically cancelled. Turn the program selector again to choose another program.

1. Alarm sound can be cancelled if it is needed. Please follow the instruction as below:

Switch on the washing machine and turn the program knob to spin cycle, then press the "Delay" and "Extra rinse" button, hold on for 3 seconds. The "bEEP OFF" will be displayed on the screen which indicates that alarm sound has been canceled. To operate the above steps again so the alarm sound can be recovered and the display will show "bEEP ON".

2. Note: During the spin process, if too much foam is inspected, in order to protect the motor, the washing machine will eliminate the foam automatically; the motor will stop and the drain pump will drain the water continuously for 90 seconds. If it happens more than 3 times, the motor will stop until the end of cycle without spinning.

## TROUBLESHOOTING

### TROUBLESHOOTING

The following circumstances do not constitute problems. Do not contact the Service Center until the problem has been confirmed.

PROBLEM	CAUSES	SOLUTIONS
Washing machine fails to operate.	<ul style="list-style-type: none"> <li>→ Poor connection to the power supply.</li> <li>→ Power failure.</li> <li>→ The washer door is not properly closed.</li> <li>→ Machine has not been switched on.</li> </ul>	<ul style="list-style-type: none"> <li>_ Check connection to the power supply.</li> <li>_ Check the power supply.</li> <li>_ Close the washer door properly.</li> <li>_ Make sure the machine is switched on.</li> </ul>
Washing machine cannot be filled with water.	<ul style="list-style-type: none"> <li>→ The "Start/Pause" button is not pressed.</li> <li>→ Water tap is not turned on.</li> <li>→ Water pressure is less than 0,03 Mpa.</li> <li>→ The inlet hose is kinked.</li> <li>→ Water supply failure.</li> <li>→ The program knob is not properly set.</li> <li>→ The washer door is not properly closed.</li> <li>→ The inlet hose filter is blocked.</li> </ul>	<ul style="list-style-type: none"> <li>_ press the "Start/Pause" button.</li> <li>_ Turn on the water tap.</li> <li>_ Check water pressure.</li> <li>_ Check the inlet hose.</li> <li>_ Ensure the water supply.</li> <li>_ Set the program knob properly.</li> <li>_ Close the washer door properly.</li> <li>_ Unblock the inlet hose filter.</li> </ul>
Machine is draining while being filled.	<ul style="list-style-type: none"> <li>→ The height of the drain hose is below 80 cm.</li> <li>→ The drain hose is in water.</li> </ul>	<ul style="list-style-type: none"> <li>_ Install drain hose within 80-100 cm of height.</li> <li>_ Make sure the drain hose is not in water.</li> </ul>
Drainage failure.	<ul style="list-style-type: none"> <li>→ Drain hose is blocked.</li> <li>→ Drain hose end is higher than 100 cm above the floor level.</li> <li>→ The filter is blocked.</li> </ul>	<ul style="list-style-type: none"> <li>_ Unblock the drain hose.</li> <li>_ Make sure the drain hose end is lower than 100 cm above floor level.</li> <li>_ Unblock the filter.</li> </ul>
Strong vibration while spinning.	<ul style="list-style-type: none"> <li>→ Not all transportation bolts have been removed.</li> <li>→ Washing machine is located on an uneven surface or is not level.</li> <li>→ Machine load is over 7 kg.</li> </ul>	<ul style="list-style-type: none"> <li>_ Remove all transportation bolts.</li> <li>_ Make sure the washing machine is on an even surface and levelled.</li> <li>_ Reduce amount of laundry in the drum.</li> </ul>
Operation stops before completing wash cycle.	<ul style="list-style-type: none"> <li>→ Water or electricity failure.</li> </ul>	<ul style="list-style-type: none"> <li>_ Check the power supply.</li> </ul>
Operation stops for a period of time.	<ul style="list-style-type: none"> <li>→ Washing machine gives an error message.</li> <li>→ Washing machine is in soaking cycle?</li> </ul>	<ul style="list-style-type: none"> <li>_ Check display codes.</li> <li>_ Press the rinse hood button or the Start/pause button again to cancel it.</li> </ul>
Excessive foam in the drum, which is spilled to the distribution drawer.	<ul style="list-style-type: none"> <li>→ The detergent is not a low-foaming type or for manual wash.</li> <li>→ Excessive use of detergent.</li> </ul>	<ul style="list-style-type: none"> <li>_ Check if your detergent is appropriate.</li> <li>_ Reduce amount of detergent in the distribution drawer.</li> </ul>
Automatic adjustment of the washing time.	<ul style="list-style-type: none"> <li>→ The washing program duration will be adjusted</li> </ul>	<ul style="list-style-type: none"> <li>_ This is normal and doesn't affect the functionality.</li> </ul>
Spinning fails	<ul style="list-style-type: none"> <li>→ Unbalance of the laundry</li> </ul>	<ul style="list-style-type: none"> <li>_ Add clothes or run a spinning program again.</li> </ul>

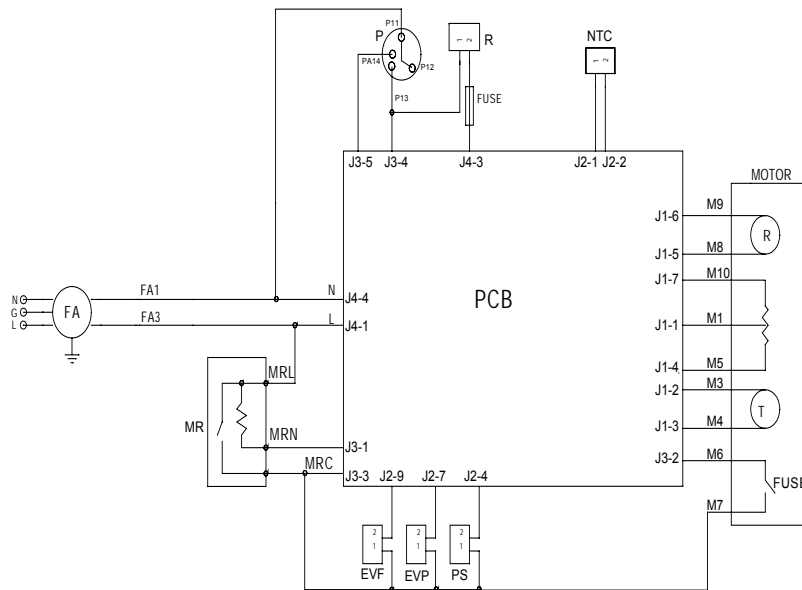
**WIRING CIRCUIT**

- Motor——Motor
- PCB——Printed Circuit Board
- MR——Door Lock
- R——Heating Element
- PS——Drainage Pump
- EVF,EVP——Water Inlet Magnetic Valve
- P——Pressure Switch
- FA——Interference Suppressor
- NTC——Temperature Sensor