

Panasonic®

Operating Instructions & Installation Instructions

Washing Machine
(Domestic use)

Model No.

NA - 140VG3

NA - 148VG3



Read Before Using	02
SAFETY PRECAUTIONS	04
Washing Instructions	12
Optional Functions	20
Maintenance	22
Troubleshooting	25
Installation Instructions	30

Thank you for purchasing this appliance.

- For optimum performance and safety, please read these instructions carefully.
- Before connecting, operating or adjusting this appliance, please read the instructions completely. Please keep this manual for future reference.

Consider the Environment

Disposing of packaging

The packaging used to protect the washing machine from damage during transportation is all recyclable. For information on recycling, contact your local authority.

Disposing of Waste Electrical & Electronic Equipment

Information on disposal for users of waste electrical & electronic equipment (private households)



This symbol on the products and/or accompanying documents means that used electrical and electronic products should not be mixed with general household waste.

For proper treatment, recovery and recycling, please take these products to designated collection points, where they will be accepted on a free of charge basis. Alternatively, in some countries you may be able to return your products to your local retailer upon the purchase of an equivalent new product.

Disposing of this product correctly will help to save valuable resources and prevent any potential negative effects on human health and the environment which could otherwise arise from inappropriate waste handling. Please contact your local authority for further details of your nearest designated disposable point.

Penalties may be applicable for incorrect disposal of this waste, in accordance with national legislation.

2 - Read Before Using

Information on disposal in other countries outside the European Union

This symbol is only valid in the European Union.

If you wish to discard this product, please contact your local authorities or dealer and ask for the correct method of disposal.

Eco-friendly Laundry

- Keep to the load limit of each programme.
- The washing machine automatically adjusts the operating time of each programme depending on the load.
- You only need to use a preliminary wash if your laundry is heavily soiled.
- Using the 60°C Cotton programme instead of the 90°C Cotton one will save energy, and will remove ordinary stains.
- For lightly soiled laundry, using the Cold Wash programme instead of the 40°C Quick 50 programme will save more energy.

Detergent amount

- Use the correct amount of detergent based on the detergent pack instructions and local water hardness.
- Adjust the amount of detergent depending on how soiled your laundry is.

When using a tumble dryer

To save energy, please select the correct spin-dry revolution speed according to the instruction of your tumble dryer.

This product complies with the directives 2006/95/EC and 2004/108/EC.

Contents

Read Before Using

Consider the Environment	2
SAFETY PRECAUTIONS	4
Checking Your Washing Machine	6
Your washing machine	6
Accessories	6
Before You Start Washing	7
Checking before use	7
Before initial use	7
Preparing the laundry	7
Using the Buttons	8
Unlocking the door	9
Adding Detergent and Other	
Chemicals	10
Detergent compartment	10
Softener compartment	11
Prewashing compartment	11

Washing Instructions

Washing	12
Setting washing	12
Required time	13
Setting the buzzer	13
Changing settings while washing	13
Selecting the Programme	14
Details of Programmes	16
Washing Delicates	18
Wool, Silk/Lingerie, and Delicates	
programmes	18
Delicate laundry loads	18
Tips for washing delicates	18
Washing Bedding and Outdoor	
Wear	19
Bedding programme	19
Putting bedding into the drum	19
Outdoor programme	19
Optional Functions	20
Individual washing functions	20
Additional functions	20
Preset timer	21
Child safety lock	21

Maintenance

Maintenance	22
Cleaning the outside of the	
appliance	22
Cleaning the drum	22
Cleaning the detergent drawer	22
Cleaning the door seal and window	23
Cleaning the drain filter	23
Cleaning the water-supply filter	24
Preventing a frozen water-supply	
hose	24

Troubleshooting

Fault Checklist	25
Error Display	29

Installation Instructions

Choosing the Right Location	30
Carrying the appliance	30
The right place for the appliance	30
Installing a built-in washing machine	31
Moving and Installing	32
Removing the anchor bolts	32
Moving the appliance	32
Levelling the appliance	33
Connecting Hoses and Power	
Supply	34
Hoses and cable lengths	34
Water-supply hose	34
Water-drain hose	35
Connecting to the power supply	35
Checking After Installation	36
Installation checklist	36
Test run after installation	37
Power and Water Consumption	38
Specifications	39

SAFETY PRECAUTIONS

Please read and follow these safety precautions.



WARNING

This describes issues which could cause death or serious injury.

General Use

- This appliance is not intended for use by persons (including children) with reduced physical, sensory or mental capabilities, or lack of experience and knowledge, unless they have been given supervision or instruction concerning use of the appliance by a person responsible for their safety.
- Children should be supervised to ensure that they do not play with the appliance.
- Do NOT place a stand or a chair close to the appliance.
Children may be able to reach the control panel or climb onto or into the appliance.
- Turn off the water supply to the appliance if it is not going to be used for a prolonged period, such as during a holiday. This is especially important if there is no drainage around the appliance.
If the water supply is left on, the water pressure may unnecessarily increase and result in a leak.
- Do NOT install the appliance in a damp location or in a location exposed to the weather.
This may result in malfunction, deterioration, electric shock, or fire.
- Do NOT pour or spill water directly onto any part of the appliance.
This may result in malfunction, electric shock, or fire.

- Keep sources of ignition, such as candles or cigarettes, away from the appliance.
They may cause a fire or damage to the appliance.
- Keep flammable materials away from the appliance, for example, gasoline, thinner, alcohol, or clothing soaked with these materials.
They may cause an explosion or a fire.

Power source and cable

- Unplug the mains lead when cleaning the appliance.
- Check the mains lead and mains plug for any damage.
If the mains lead is damaged, it must be replaced by the manufacturer, its service agent or similarly qualified person to avoid a hazard.
- Do NOT use a mains plug adaptor or extension cable. There is a possibility of overheating which may cause a fire. Use an unused household mains socket, fully rated at AC 220 V to 240 V. If you are not sure, contact a qualified electrician.
- ENSURE the mains plug is fully inserted into the household mains socket. If the mains plug is not fully pushed in, a loose connection may overheat and cause an electric shock or fire.
- Do NOT touch the mains lead or mains plug with wet hands.
Possibility of an electric shock.
- Do NOT pull the mains lead but hold the mains plug to unplug the appliance.
Otherwise, there is possibility of damage to the mains lead, which may lead to an electric shock or fire.

4 - Read Before Using

SAFETY PRECAUTIONS

To Prevent Injury

- The installation of the appliance should be done by the manufacturer's dealer or service agent.
If the installation, test run and inspection of the appliance are not carried out following the installation method outlined in these instructions, the manufacturer will not be liable for any accident or damage caused.
- Do NOT dismantle, repair or modify the appliance.
There is a possibility the appliance may malfunction which may result in a fire or an injury. If repairs are needed, contact your local Customer Service Centre.
- Do NOT touch the laundry inside the drum until it has completely stopped, as there is a possibility of injury. Keep children away from the rotating laundry.



CAUTION

This describes issues which could cause injury or damage your belongings.

General Use

- Prior to use, turn on the tap and check the hose and connections for any leaks. Improper connection could cause leaks.
- The new hose-sets supplied with the appliance are to be used and that old hose-sets should not be reused.
- This appliance is only suitable for textiles labelled washing machine washable.
- Do NOT connect to the hot water supply. This appliance works ONLY with cold water.
- Do NOT apply pesticide, hair spray or deodorant to the appliance.
- Do NOT put any electrical equipment, for example, TVs, radios or battery chargers, on or near the appliance.
- Do NOT put too much laundry or detergent into the appliance. This may cause damage to the appliance.
- REMOVE the anchor bolts before installing the appliance using a spanner supplied or similar tool. The anchor bolts are used to transport the appliance. If the anchor bolts are not removed, the appliance will strongly vibrate during use.
- If this appliance is supplied from a cord extension set or electrical portable outlet device, the cord extension set or electrical portable outlet device must be positioned so that it is not subject to splashing or ingress of moisture.

To Prevent Injury

- Do NOT climb onto the appliance. This may cause injury or damage to the appliance.
- Keep fingers away from the door hinge when opening and closing the door.
- Do NOT slide your hand (or unprotected foot) underneath the appliance when in use.
- Check all washing and remove all objects such as nails, pins, coins, clips, metal wires, etc.
They may cause damage to other laundry or the appliance.
- Do NOT use the appliance to wash waterproof sheets or clothing. There is a possibility of excessive vibration or failure during the spin-drying cycle that may result in an injury, damage to the appliance or a water leak.
- BE CAREFUL when draining hot water or any detergent out of the drum.
- BE CAREFUL not to get laundry caught in the door seal when it is closed. This may result in a water leak or damage to the laundry during the wash cycle.

Read Before Using - 5

Checking Your Washing Machine

Your washing machine

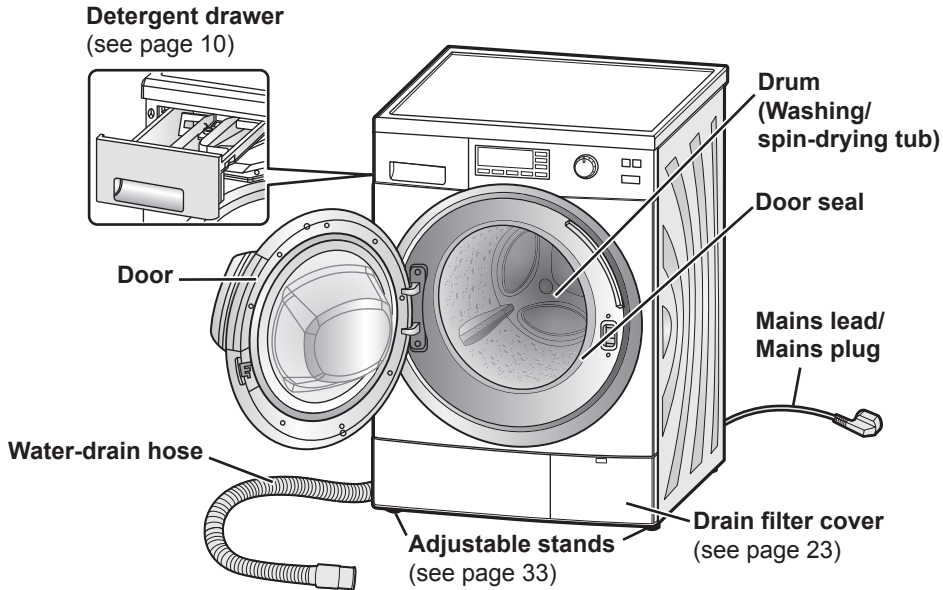

Caution

Do NOT bend the mains lead when the appliance is running.

Accessories

Make sure that all the accessories are supplied with the appliance.

Elbow (see page 35)

For fixing the water-drain hose



Spanner (see pages 32-33)

End A is for adjusting the stand. End B is for the anchor bolts.



Cover cap (x4) (see pages 32-33)

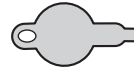

Water-supply hose (see page 34)

Either one of these hoses is supplied with the appliance.

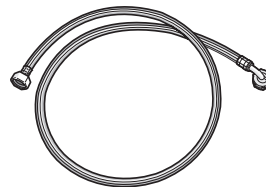

Standard
Hose

Hose with
water-supply valve

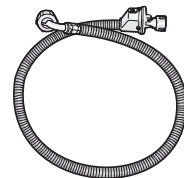

6 - Read Before Using

Before You Start Washing

Checking before use

For the appliance's initial operation or after a prolonged period of non-operation, perform the following procedures:

1. **Secure the water-supply hose.**
2. **Open the tap.**
3. **Connect the power.**
4. **Make sure that the water-drain hose is positioned towards a drain.**

For more details, see page 35.

Before initial use

The default setting is the 40°C Cotton programme. For the appliance's initial operation, operate it **WITHOUT** any detergent or clothing to rinse out residue or moisture.

Note

There may be drops of water or condensation in the appliance due to the factory inspection prior to shipment. This is not a malfunction.

Preparing the laundry

Sorting clothing

- Read clothing washing labels to help you sort them into different loads.
- Sort the laundry by colour, by type of fabric, and by how soiled it is. Doing so will help you choose the correct programme and temperature for each wash.
- Clothes that are not colour fast should be washed separately. Wash denim separately.



- You should put bras with metal wires, tights, lace clothing and small items of clothing into a laundry net to prevent them or the appliance from getting damaged.



Treating stains

Apply stain remover to stained portions. For dirt and solid stains, wash lightly by hand first.

Checking clothing

- Check that pockets on clothing do not contain any objects that may damage the clothes or the appliance.

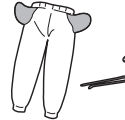

- Tie up any loose strings on the clothing and close zippers. Turn clothing with raised fabrics and zippers inside out. Otherwise, the clothes may be damaged.

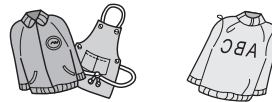

- Remove any hair, animal fur, sand, and other materials with a brush before washing.



Using the Buttons

Model NA-148VG3

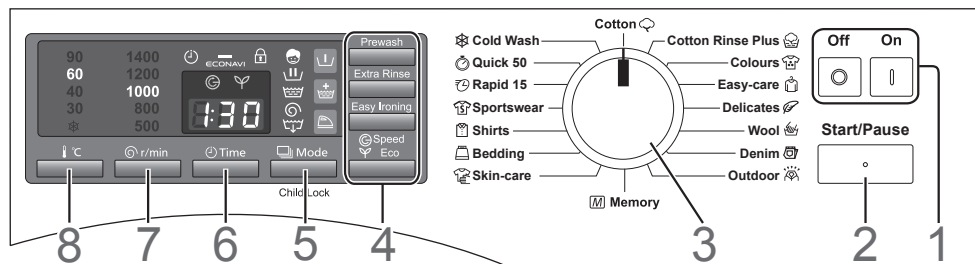

1. Power buttons

- If you do not press the Start button within 10 minutes after the appliance has been switched on, the appliance automatically switches itself off.
- The display below appears for 3 seconds after the appliance has been switched off. You cannot turn the appliance on until this display disappears.



2. Start/Pause button

Press this button to start or pause the wash programme.

3. Programme selection dial

Use this dial to choose the best programme for the laundry. (See pages 14-15.)

4. Additional function buttons

Press these buttons to add functions to the programme to suit the laundry. (See pages 20-21.)

5. Mode/Child Lock button

- Press this button to select the function of processes, for example, the Rinse and Spin function or the Drain only function. (See page 20.)
- Press and hold this button to set the child safety lock. The door and the controls will be locked. (See page 21.)

6. Time button

Press this button to preset the time for when the washing finishes. (See page 21.)

7. Spin speed button

Press this button to see the spin speed (r/min) or to choose the spin speed for the programme you have selected. (The maximum spin speeds of model NA-140VG3 and NA-148VG3 are 1400 r/min.)

8. Temperature button



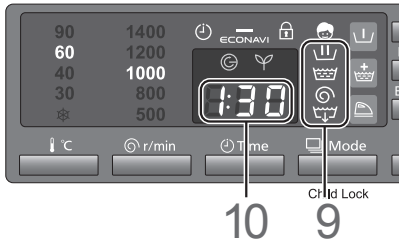

Press this button to choose water temperatures ranging from cold to 90°C. You can choose hotter temperatures for whites, cottons, or soiled laundry.

Using the Buttons

Display on NA-148VG3



9. Process indicator

- This indicator shows the current process of the programme. The process consists of wash , rinse , spin , and drain .
- The light goes off when the wash is finished.

10. Remaining time indicator

- This indicator shows the approximate time until the washing finishes. For example, '1:18' means 1 hour and 18 minutes.
- The time is acquired from the weight of the laundry measured when washing starts.

Unlocking the door

The door automatically locks while in use, and the  symbol is shown while the door is locked. A click will be heard when the door locks or unlocks.

Note

- While the door is locked, if the appliance is switched off, or if there is a power interruption, the door stays locked until the switch is turned on again.
- This is different from the child safety lock. (See page 21.)

Press the Start button to unlock the door during operation.

After about 1 minute, the drum stops spinning, and the door will automatically unlock.

If the door doesn't open, see page 25.

Caution

If you have to unlock the door mid-programme, make sure that water from the drum does not overflow onto the floor.

Water and soap suds might come out of the door and the door opening. You may need a towel to soak them up.

Adding Detergent and Other Chemicals

Pull out the detergent drawer and add detergent or softener to the correct compartment. Check the packages for the appropriate recommended amounts.

Caution

Do NOT use the appliance when the detergent drawer is removed.

This may result in a water leak.

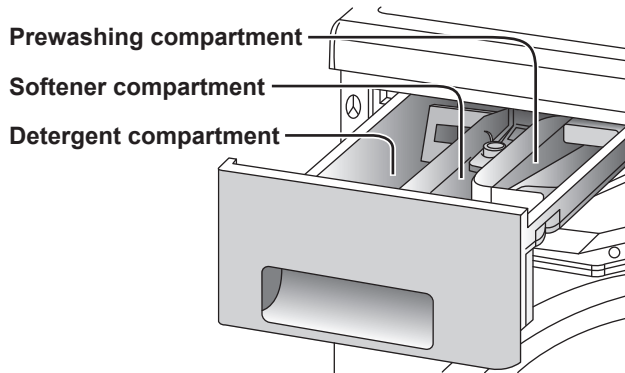

Detergent compartment

The following detergents and additives may be added to this compartment:

- Detergent
- Water softening agent
- Stain remover
- Tub cleaning detergent or bleach

If you use multiple chemicals in this compartment for washing, add them in the following order:

1. Detergent
2. Water softening agent
3. Stain remover

Detergent

Use only detergents that are recommended for fully-automated washing machines. Please use low suds detergents.

Caution

If the instructions on the package indicate that detergent should be placed in the drum, do NOT put it into the detergent drawer.

These detergents may not flow well and remain in the detergent drawer.

1. Liquid detergent

Note

Do NOT use liquid detergent with the Prewash function. It may flow away during the prewash.

For the Wool programme, use mild liquid detergent.

2. Powdered detergent

Detergent reaches the drum only when water flushes through the detergent drawer. Thus, if you forget to add detergent, run the Drain only function using the Mode button.

Adding Detergent and Other Chemicals

Then, add detergent and start washing again.

To prevent powdered detergent from remaining in the drawer, perform the following:

- Dry the inside of the drawer with a cloth.
- Make sure that the detergent is not lumpy when you add it as this may cause a blockage over time.

Amount of Detergent

The amount of detergent you should use depends on the following factors:

- How soiled the laundry is
- The amount of the laundry
- Water hardness

The amount of foam varies according to the amount and type of detergent, how soiled the laundry is, and the hardness and temperature of the water.

Water softening agent

If you live in a hard water area (total hardness of 1.3 mmol/L or higher), we recommend the usage of a water softening agent. For more details on water hardness, contact your local water authority.

Use of a water softening agent can help reduce the amount of detergent that is required for each wash and help prevent the formation of limescale deposits, which may damage the appliance.

Softener compartment

The following additives may be added to this compartment:

- Fabric softener
- Laundry starch

Fabric Softener

To prevent static, add softener before you start washing. It will be automatically added in the final rinse cycle.

Dilute concentrated softeners before you add them. Add up to only 130 ml to the compartment to avoid overflowing.



Rinse out the remaining softener with a splash of water or a damp cloth after washing. If it sticks to the compartment, pull out the drawer and clean it out. (See page 22.)

Laundry starch

Simply add laundry starch to the softener compartment. It will be automatically added to the clothing as part of the final rinsing process. Make sure that you do not fill the compartment over the MAX level.

If it is hard to pour, you can dilute the starch slightly with water before adding it.

Note

After using starch, clean the detergent drawer, especially the softener cover (see page 22). Then, run the Rapid 15 programme WITHOUT detergent to remove any excess starch in the drum.

Prewashing compartment

Detergent for prewashing

Whenever you use any programmes with the Prewash function, always put detergent for the prewash in this compartment.

Washing

Setting washing

Model NA-148VG3

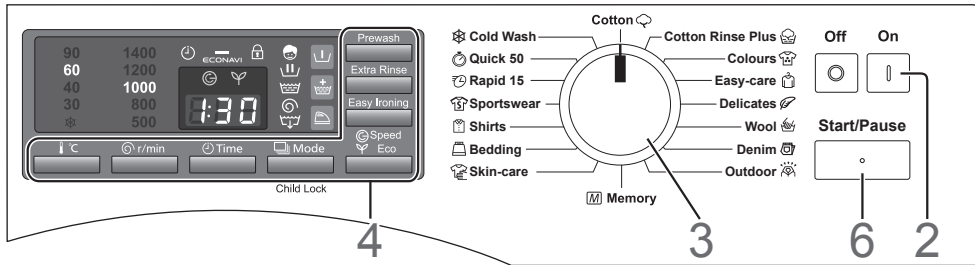

1. Open the door and put the laundry into the drum.

For details about preparing and sorting the laundry, see pages 7, 14, and 15.

Caution

- Make sure that no laundry gets caught in the door.
- Do NOT overload the drum. This may cause excessive vibration or damage to the appliance.

2. Close the door and press the On button.

3. Turn the programme selection dial either way to select the programme.

A wash time will be displayed.

Memory programme

You can design your own programme based on the default settings of the Cotton programme. Select Memory programme and set other settings, then run the programme. Later, this preset programme can be run by simply accessing Memory programme.

Cold Wash programme

This programme detects the amount of clothes and water temperature, and then selects the best suited wash time and water amount to save energy and conserve water.

The less the amount of clothes and the higher the water temperature, the shorter

the wash time and smaller amount of water will be used. The ECONAVI mark flashes while clothes are checked and lights when the ECONAVI function starts working.

Cotton Rinse Plus programme

This programme has rinse performance better than the cotton programme.

4. Select optional functions.

- Process selection (See page 20.)
 - Additional functions (See page 20-21.)
 - Temperature (See page 8.)
 - Spin speed (See page 8.)
- For more details about available functions and settings for each programme, see pages 16-17.

5. Add detergent to the detergent drawer.

(See pages 10-11.)

6. Press the Start button.

The appliance starts supplying water. After the appliance has started, the laundry is weighed. After about 5 seconds, a new wash time will be displayed. If you select the Wool/Silk, Bedding, Sportswear, Rapid 15, or Shirt programmes, the laundry is not weighed.



The buzzer will sound when the programme has finished, and the door will unlock immediately.

12 - Washing Instructions

Caution

After a high temperature wash, be careful to not burn yourself when handling the laundry or touching the inside of the drum.

Note

- If the detergent is not completely removed from the laundry by using the basic programme, use the Extra Rinse function.
- With the Eco and the Speed functions, if the load is big, the laundry may stick to the inside of the drum. This is normal.

- Remove the laundry and rearrange where necessary. Do not leave it in the drum too long after the programme ends, because colours may run.

Required time

Times depend on the programmes and temperature settings that have been selected.

- Actual times may differ slightly from those shown.
- The displayed times include the time needed for the water to fill up and to drain out, thus they vary depending on water pressure, drainage and amount of laundry.
- If you change the functions while washing, the displayed times may change.
- If the laundry in the drum needs to be balanced, times will be extended.

Setting the buzzer

The buzzer that sounds when a programme finishes can be turned off.









- 1. Press the Start and On buttons at the same time.**
- 2. Release the On button and keep pressing the Start button for 3 seconds. The buzzer setting will be turned off after a beep is heard.**
If you wish to reset the setting, perform the same steps 1 and 2. The buzzer setting will be turned on after two beeps are heard.

Changing settings while washing

After washing has started, the programme, temperature, and preset time cannot be changed.











- To change the programme or temperature settings, turn the appliance off and then on again.
- To change the rinse or spin settings while washing, press the Pause button once the appliance is full of water.
- You can change the Spin-dry revolution, Extra Rinse and Easy Ironing function during the washing process.
- No settings can be changed after the washing process has finished.

Selecting the Programme





















Programme	Description	140VG3 Max load	148VG3 Max load
 Cotton	Daily washing for cotton, linen and cotton blend items (For examples, T-shirts, underwear, towels, tablecloths)	10 kg	8 kg
 Cotton Rinse Plus	Washing takes longer overall but rinsing is more thorough than the Cotton programme.	10 kg	8 kg
 Easy-care	Gentle washing for cotton, linen, and synthetics.	5 kg	4 kg
 Delicates	Gentle washing for synthetic fibres, textiles, satin, lace, etc.	5 kg	4 kg
 Wool	Gentle washing for hand wash only wool, machine washable wool, and wool blends	2 kg	2 kg
 Silk/Lingerie	For lingerie and washable silk items. Washes gentler than the Wool programme.	2 kg	—
 Quick 50	Washes lightly soiled items in 50 minutes.	5 kg	4 kg
 Rapid 15	Washes a few lightly soiled items in 15 minutes.	2 kg	2 kg
 Colours	For washing coloured cottons or coloured cotton blend items separately	5 kg	4 kg

14 - Washing Instructions

Selecting the Programme

Programme	Description	140VG3 Max load	148VG3 Max load
 Mixed	For items with mixed fabrics, for example, cotton, linen and synthetic fibres	10 kg	—
 Cold Wash	For lightly soiled cottons, and linen blends.	10 kg	8 kg
 Memory	Programme based on the Cotton programme featuring selected optional functions and settings.	10 kg	8 kg
 Baby-care	For babywear	5 kg	—
 Skin-care	For items that need to be gentle to the skin, for example, underwear, sheets, towels, and baby clothes. Items are spray washed and thoroughly rinsed.	—	4 kg
 Shirts	For shirts and blouses	2 kg	2 kg
 Sportswear	For synthetic sportswear	3 kg	3 kg
 Bedding	For large items, for example, blankets, curtains, and bedspreads	3 kg	3 kg
 Outdoor	For synthetic fabric outdoor wear and water-repellent clothing	—	3 kg
 Denim	The spray washing is used to prevent jeans from fading.	—	2 kg

Details of Programmes

Programme	Available programme		Auto setting				
	140VG3	148VG3	Temperature	Number of rinses	Spin-dry revolutions	Approximate	
						140VG3	
 Cotton	✓	✓	40°C	2	1200	1:09 - 2:04	
 Cotton Rinse Plus	✓	✓	40°C	2	1200	1:22 - 2:12	
 Easy-care	✓	✓	40°C	2	800	1:01 - 1:31	
 Delicates	✓	✓	40°C	2	800	0:55 - 1:00	
 Wool	✓	✓	30°C	3	500	0:40	
 Silk/Lingerie	✓	—	30°C	3	500	0:40	
 Quick 50	✓	✓	40°C	2	1200	0:46 - 0:49	
 Rapid 15	✓	✓	30°C	1	800	0:15	
 Colours	✓	✓	40°C	2	1200	0:58 - 1:23	
 Mixed	✓	—	40°C	2	1200	1:09 - 1:44	
 Cold Wash	✓	✓		2	1200	0:54 - 2:19	
 Memory	✓	✓	—	—	—	—	
 Baby-care	✓	—	40°C	3	1200	1:29 - 2:04	
 Skin-care	—	✓	40°C	3	1200	—	
 Shirts	✓	✓	40°C	2	500	1:08	
 Sportswear	✓	✓	40°C	2	800	1:30	
 Bedding	✓	✓	30°C	2	800	1:02	
 Outdoor	—	✓	30°C	3	800	—	
 Denim	—	✓	30°C	2	800	—	

16 - Washing Instructions

Details of Programmes

time	Manual setting		Additional functions			
	Temperature	Spin-dry revolutions	Eco Speed	Extra Rinse	Prewash	Easy Ironing
140VG3 148VG3						
1:09 - 1:49	Cold - 90°C	500 - 1400	✓	✓	✓	✓
1:22 - 1:57	Cold - 90°C	500 - 1400	✓	✓	✓	✓
1:01 - 1:21	Cold - 60°C	500 - 1200	✓	✓	✓	✓
0:55 - 1:00	Cold - 40°C	500 - 800	—	✓	✓	✓
0:40	Cold - 40°C	500	—	✓	—	—
—	Cold - 40°C	500	—	✓	—	—
0:46 - 0:49	Cold - 60°C	500 - 1400	—	✓	✓	✓
0:15	Cold - 30°C	500 - 800	—	—	—	—
0:58 - 1:13	Cold - 40°C	500 - 1400	✓	✓	✓	✓
—	Cold - 40°C	500 - 1400	✓	✓	✓	✓
0:54 - 2:04	Cold	500 - 1400	—	✓	✓	✓
—	Cold - 90°C	500 - 1400	✓	✓	✓	✓
—	Cold - 90°C	500 - 1200	✓	✓	✓	✓
1:29 - 1:49	Cold - 90°C	500 - 1200	✓	✓	✓	✓
1:08	Cold - 60°C	500 - 800	✓	✓	✓	✓
1:30	Cold - 40°C	500 - 1200	✓	✓	✓	✓
1:02	Cold - 40°C	500 - 800	—	✓	—	✓
1:48	Cold - 40°C	800	✓	✓	✓	—
0:55	Cold - 40°C	500 - 1200	✓	✓	✓	✓

Washing Instructions - 17

Washing Delicates

Wool, Silk/Lingerie, and Delicates programmes

The drum spins gently in these programmes.

For details about washing instructions, see pages 12-13.

Delicate laundry loads

- Wool programme: 2 kg or less
- Delicates programme: 5 kg or less (140VG3), 4 kg or less (148VG3)
- Silk/Lingerie programme: 2 kg or less

Approximate weights

- Wool sweater: 400 g



- Silk blouse: 200 g



- Trousers: 400 g

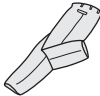

Tips for washing delicates

Putting laundry in the drum

Pile them one on top of each other.

Detergents

- For wool items, use a mild liquid detergent. Other detergents may damage the clothes.
- With Wool, Delicates, and Silk/Lingerie programmes, you may need to use the Extra Rinse function to remove excess detergent from the laundry. (See page 20.)

Hanging the laundry

- Hang out white or light-coloured wool and nylon items away from direct heat or sunlight.
- After washing, lay out wool and nylon clothes, and return them to their normal shape before hanging in the shade. This saves on ironing too.
- Hang wool items without folds or creases, or spread them out to dry.

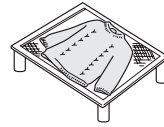
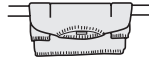

- Use hangers for shirts, blouses and trousers.
You may wrap a towel around the hanger to approximate the clothing's shoulder width so that it will retain its shape as it dries.



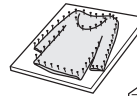

If clothing shrinks in the wash

Spread the item out to its original size on an ironing board. Use dress pins to hold the size and shape. Then, use an iron to steam it and leave it to dry.



Washing Bedding and Outdoor Wear

Bedding programme

- Make sure that the label of each item to be washed shows either the wash or handwash symbol (, ).
- Wash only one blanket at a time.

Washable

- 100% synthetic fibre blankets – up to 3 kg
- 100% synthetic fibre futons and 100% cotton blankets – up to 1.5 kg (single bed size)
- Sheets
- Bedspreads
- 100% synthetic fibre undersheets

Non-washable

- 100% wool blankets
- Long-piled blankets
- Electric blankets (including cover)

Putting bedding into the drum

1. Fold down blankets or bedspreads into a quarter of their original size.

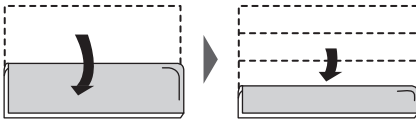

2. Put the blanket or bedspread to the drum.

Fold it while putting it into the drum.

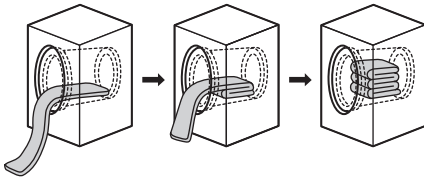

Both ends of blanket should be directed inward the drum.

Caution



Do NOT roll blankets or bedspreads into balls, nor haphazardly fold them.

This may cause excessive vibration and damage the laundry or the appliance.

Note

Avoid using blanket nets. They prevent the laundry from spinning properly.

Outdoor programme

Make sure that the label of each item to be washed shows either the wash, handwash, or no dry cleaning symbol (, , ).

Washable

Synthetic fabric outdoor wear, for example, rainwear, outerwear jackets and trousers – up to 3 kg

Non-washable

- Clothing with cotton lining or padding, or down feathers
- Sleeping bags and synthetic fabric covers

Note

- Before washing, close any zippers and button up the clothing.
- Do not wash clothing in laundry nets by itself because the load will be unbalanced and not be smoothly washed.
- Water repellent finishes might be washed out over time. To restore water repellency, iron the garment with a low temperature setting, dry it in a dryer, or re-apply a commercially available water repellent treatment. If a treatment is used, follow the product's instructions, or the instructions in the garment.
- We recommend laying down towels in front of the appliance when taking out water-repellent clothing after the spin cycle because water may drip from the clothing.

Optional Functions

Individual washing functions





(Process selection)

You can select a single process, or combine several processes by selecting individual washing functions.

Note

You cannot select individual washing functions in the Rapid 15 programme.

Press the Mode button  to select a function.

Function	Description
Rinse only 	Rinse washed laundry (Rinse water remains)
Spin only 	Spin-dry washed laundry
Wash - Rinse 	Wash and rinse laundry (Rinse water remains)
Rinse - Spin 	Rinse and spin-dry washed laundry
Drain only 	Drain water from the drum

- Whenever you start washing, the process display flashes to show which function is in progress.
- With the Spin only or Rinse - Spin function, if there is any water in the drum operation starts from the drain process.

Additional functions





Depending on the programme, you can combine different additional functions.

Note

Some additional functions cannot be used with certain programmes. (See pages 16-17.)

If you select an unavailable function, an error alarm will sound.

Press one or more of the function buttons  you wish to combine.

Function	Description
Eco 	Washing consumes less energy and water but takes longer.
Speed 	Washing times will be shorter than those of the basic programmes, suitable for lightly soiled laundry.
Extra Rinse 	Rinse your laundry more thoroughly with an extra rinsing process.
Prewash 	Prewash cycle for heavily soiled laundry
Easy Ironing 	<ul style="list-style-type: none"> - Make ironing easier by spin-drying your laundry more gently (at 800 r/min or less). - After washing has finished, the laundry is rotated intermittently for up to 30 minutes or until the door is opened. - Reduces wrinkles and helps to unravel tangled laundry.

Optional Functions

You can activate or deactivate the Extra Rinse and Easy Ironing functions during a washing process but not after it has finished.

Some additional functions cannot be used with certain programmes. (See pages 16-17.)

Preset timer

You can use the timer to preset the time for when the washing finishes.

- You cannot preset the Wool and Silk/Lingerie programmes.
- The wash might finish before or after preset times depending on the kind of laundry, the temperature, and the conditions of water supply and drainage.

Note

Do NOT use detergent which does not dissolve thoroughly with the preset function, because the detergent might cake up before the wash starts and not flow out.

Setting a preset time

Continuously press the Time button until the desired preset time is displayed.

Changing a preset time

1. Press the Off button, and then press the On button.
2. Choose the desired programme and optional functions.
3. Set a preset time.

Cancelling a preset time

Press the Off button. (All settings will be cancelled.)

Checking a preset time

Press the Time button.

Child safety lock

The child safety lock prevents children from climbing into the drum and getting trapped. This function keeps the door closed and locked even when the appliance is not in use. It also disables the control buttons.

Activating/deactivating child safety lock

1. Switch on the appliance.
2. Press and hold the Mode button for at least 5 seconds.
The  symbol light up to show that the child safety lock is activated.
3. To deactivate, hold down the mode button again for 5 seconds (please ignore three beeps heard, keep mode button pressed until it unlocks)

Maintenance

Cleaning the outside of the appliance

Clean the outside of the appliance with a soft cloth and mild detergent, for example, kitchen detergent, and soapy water.

Warning

- Do NOT splash water over the appliance.
- Do NOT use cream cleansers, thinners, nor products containing alcohol or paraffin oil.

Cleaning the drum

If you keep using cold water in the appliance, bacteria may build up inside the drum and give off an odour. You can avoid this by running the 90°C Cotton programme once a month. (If you use a scale remover, follow the manufacturer's instructions.)

Caution

Viruses and bacteria are not killed in water temperature of 40°C. Pathogens can spread via the commingling of clothes and thus transmit diseases.

Pathogens die at 60°C or higher. However, using water temperatures up to 90°C is unnecessary.

Note

Do NOT put laundry nor laundry detergent into the appliance while it is being cleaned.

If you use tub cleaning detergent or bleach, put it into the detergent drawer before starting the wash. The appropriate amount to be used is about 30 ml. (See pages 10-11.)

Cleaning the detergent drawer

Detergent residue soon builds up if the detergent drawer is not cleaned regularly. Detergent build up may develop mould.

1. Pull out the detergent drawer.

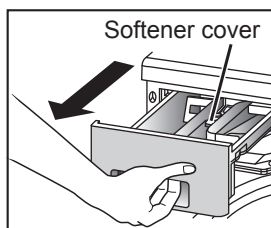

2. Remove the detergent drawer by simultaneously lifting and pulling it.

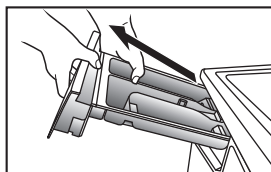

3. Pull your finger on the tab near the front of the softener cover then pull it up to remove it from the detergent drawer.

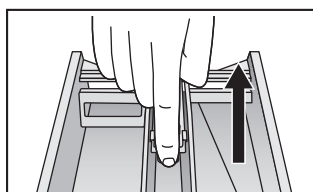

4. Wash out the old detergent with water.

Use a cloth to wipe the water from the appliance.

5. The softener cover press it down to move to original point of detergent drawer. Then move the detergent drawer by inserting.

Cleaning the door seal and window

After each wash, perform the following:

- Remove any objects from the door seal.
- Wipe the window and seal to remove lint and stains.

Cleaning the drain filter

We recommend cleaning the drain filter every 1 month. Filter will have lint buildup, reduces the water from the shower.

1. Switch off and unplug the appliance.
2. Open and remove the drain filter cover. Remove the cover and place a container to receive the drain water.

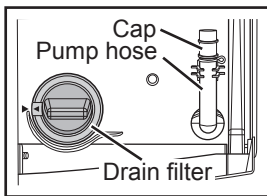

3. Pull out the pump hose and remove the cap to drain the water.

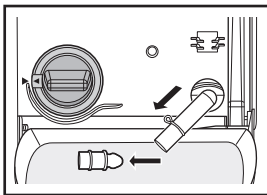

4. After all the water has drained away, loosen the drain filter.
5. Carefully loosen the drain filter. More water may drain out. This is normal.
6. Turn the drain filter anticlockwise to unscrew it. Then, remove it.

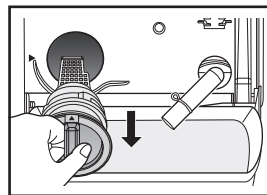
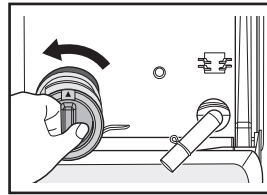

7. Remove any lint and debris.
8. Replace the drain filter.
9. Replace the cap and pump hose to the original position.

Caution

BE CAREFUL when draining hot water.

Maintenance

Cleaning the water-supply filter

Clean the filter if water is not supplied properly.

1. Turn the tap off.
2. Switch on the appliance.
3. Select the Cotton programme, and then press the Start button.
4. After 1 minute, switch off the appliance. Water has drained out of the water-supply hose.
5. Disconnect the water-supply hose from the appliance.
6. Clean the filter, which is on the rear of the appliance.
Use a small brush, for example, a toothbrush.

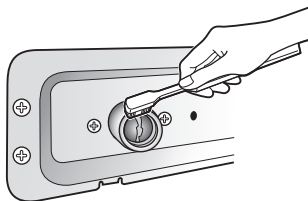

7. If the unit is supplied with the hose fitted with a water-supply valve turn off the tap supplying the appliance, disconnect the hose from the tap, and then clean the filter on hose in the same way.

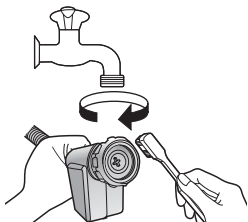

8. Reconnect the water-supply hose.
Tighten the plastic joint firmly.

9. Turn on the tap, then check for leaks.

Preventing a frozen water-supply hose

If the appliance is delivered in freezing weather conditions, after setting up, leave it at room temperature for 24 hours before using. This will ensure that the water-supply hose does not get clogged up with ice.

If your water-supply hose freezes, perform the following procedures:

1. Wrap warm towels around the joints of the water-supply hose.

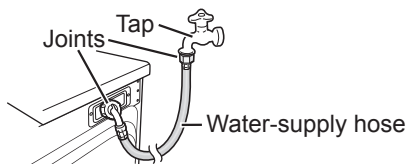

2. Add 2 to 3 litres of warm water to the drum.

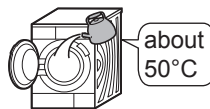

3. Start washing with the Drain only function, using the Mode button. (See page 20.)

Fault Checklist

Problem		Cause
Washing machine	Buttons do not work.	<ul style="list-style-type: none"> - The programme, temperature and process settings cannot be changed while washing is in progress (the rinse or spin settings can be changed). - Child safety lock may be activated. (See page 21.)
	Door does not open.	<ul style="list-style-type: none"> - Door lock may be activated. (See page 9.) - Child safety lock may be activated. (See page 21.) - The water temperature or level may be too high.
	Unusual odour	<ul style="list-style-type: none"> - Rubber parts may give off a smell when you start using the appliance, but the smell will go away over time. You can wash the drum by running the 90°C programme. (See page 22.)
Wash	No water going into the appliance.	<ul style="list-style-type: none"> - The water tap might be turned off. - The water-supply hose may be frozen. (See page 24.) - The water supply may be disrupted. - The water-supply filter may be clogged. (See page 24.)
	There is only a small amount of water.	<ul style="list-style-type: none"> - If you have paused the washing and then restart it, the appliance may drain out some water. Do NOT pour water in through the door.
	Water builds up during the washing.	<ul style="list-style-type: none"> - This is normal; water is automatically supplied if the amount of water has decreased. For heavy loads, the water may fill up repeatedly.
	Water drains out during the washing.	<ul style="list-style-type: none"> - This is normal; the water frequently drains out and builds up in order to wash away excess foam. This feature is called foam detection.

Fault Checklist

Problem		Cause
Rinse/Spin	No water flows into the appliance during the rinsing process.	- Before rinsing, the appliance spins to drain out remaining water. The water will fill up after that.
	Rinsing begins before the spin process finishes.	- The appliance may have detected an unbalanced load, which is caused by the laundry shifting to one side of the drum, so rinsing started automatically to correct the imbalance. - After washing, excess foam may remain, so the water is drained out and refilled to wash it away. This feature is called foam detection.
	During spin-dry, the drum stops and rotates several times.	- This is normal; the appliance has detected an unbalanced load and is trying to correct it.
	Foam and water remain in the door or door seal.	- Although some foam and water might remain depending upon the state of the laundry and the amount of detergent used, the performance of the rinse cycle is unaffected.
	Spin cycle repeatedly starts and stops.	- This is normal; intermittent spinning of the tub helps the spin process to operate quietly. - The laundry may be too light. If so, add one or two bath towels.
Time	The displayed remaining time changes.	- The remaining time is estimated and corrected continually. Thus, the time displayed may change. - The remaining time increases if an extra rinsing and spinning are required to correct an unbalanced load, which is caused by the laundry shifting to one side of the drum.

Fault Checklist

Problem		Cause
Detergent and foam	There is no foam or hardly any foam.	<ul style="list-style-type: none"> - The amount of foam varies, depending on the temperature, level and softness of the water. - You may have put powdered detergent directly into the drum; you must put it in the detergent drawer. - You may not be using enough detergent. - You may be using a reduced-foam type of detergent. - Heavily soiled laundry and larger loads of laundry may reduce the amount of foam.
	There is a lot of foam.	<ul style="list-style-type: none"> - The amount of foam varies, depending on the temperature, level and softness of the water. - You may have used too much detergent. - The type of detergent you are using may cause excess foam.
	Fabric softener overflows.	<ul style="list-style-type: none"> - The softener may have exceeded the MAX level for the detergent drawer. (See page 11.) - You may have spilt the liquid by closing the detergent drawer too strongly.
	After the wash has finished, powdered detergent residue remains.	<ul style="list-style-type: none"> - You may have put powdered detergent directly into the drum; you must put it in the detergent drawer.
Noise	There is an unusual noise or vibration.	<ul style="list-style-type: none"> - There may be metal items in the drum. - The anchor bolts may not have been removed. (See page 32.) - The appliance may be on a sloping or unstable surface. <p>If none of the above is the cause, contact your local Customer Service Centre.</p>
	There is noise when the water drains out.	<ul style="list-style-type: none"> - This is normal; it is noise created by the operation of the drain pump.
	The fan makes noise.	<ul style="list-style-type: none"> - This is normal; the fan is cooling off the electric parts.

Fault Checklist

Problem		Cause
Others	The electricity supply cuts out while the appliance is on.	- The appliance will stop, and will not start by itself when the power comes back on. You have to select a programme and start it again.
	A circuit breaker trips the electricity supply.	- The appliance stops, and will not start by itself when you reset the breaker. You have to find out what caused the breaker to trip and solve it. Then, reset the breaker to turn the electricity supply back on, and switch on the appliance again.
	The water supply is disrupted.	- When the water is supplied again, it may be impure at first. You have to disconnect the water-supply hose and drain away the impure water through the tap. Make sure that the water-supply hose has been reconnected before using the appliance.
	The display is not clear.	- The appliance may be in a brightly lit or sunlit area.

Error Display

<p style="text-align: center;">U 11</p> <p style="text-align: center;">Unable to drain</p>	<p>What to do</p> <p>Check the drain hose for any of following problems.</p> <ul style="list-style-type: none"> - It clogs up. - Its tip is immersed in water. - It extends further than 3 m. - The water is frozen. <p>Clean the drain filter if it clogs up. (See page 23.)</p> <p>After correcting the problem, open the door, close it, and then start the wash again.</p>
<p style="text-align: center;">U 12</p> <p style="text-align: center;">Door is open</p>	<p>What to do</p> <p>Make sure that the door is shut properly.</p>
<p style="text-align: center;">U 13</p> <p style="text-align: center;">Unable to spin-dry</p>	<p>The appliance has been designed to detect unbalanced loads, especially small loads, in order to ensure quiet operation and achieve the best results.</p> <p>This is not a malfunction. Perform any one of the following solutions.</p> <p>What to do</p> <ul style="list-style-type: none"> - If the laundry is too heavy, untangle clumps of clothing. - If the laundry is too heavy because items, such as blankets, are too large, reduce the load. - If the laundry is too light, add one or two bath towels. - If the appliance is on an unstable or uneven surface, change the setting location. <p>After correcting the problem, open the door, close it, and then start the wash again.</p>
<p style="text-align: center;">U 14</p> <p style="text-align: center;">Unable to supply water</p>	<p>What to do</p> <p>Check for any of following problems.</p> <ul style="list-style-type: none"> - The tap is closed. - The water pipe or hose is frozen. - The water supply has been disrupted. - The water-supply filter is clogged. (See page 24.) <p>After correcting the problem, open the door, close it, and then start the wash again.</p> <p>If the red mark appears in the hose with water-supply valve, it have been stop the water supply.</p> <p>You should replace with a new hose.</p> <p>Hose with water-supply valve (No.AXW12C-7SR0)</p>
<p style="text-align: center;">H 01</p>	<p>An error display starting with H.</p> <p>What to do</p> <p>Press the Off button. If the display stays on, or if it reappears when you press the Start button, unplug the appliance and contact your local Customer Service Centre.</p>

Choosing the Right Location

Carrying the appliance

The appliance must be carried by 2 or more people.



Start by tilting the appliance backwards. One person should stand behind it, holding the rear of the top panel. The other person should grip the bottom stands in the front.

The right place for the appliance

Make sure that there is enough space for the appliance and that openings on the base are not obstructed by a carpet.

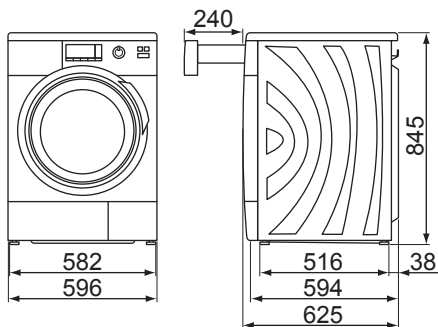

Dimension in millimetres

Caution

- Install the appliance on a flat, stable surface to avoid excessive vibration and noise. If the floor is not flat and stable, contact your local Customer Service Centre.
- Do NOT install the appliance in direct sunlight or in a place where temperatures reach freezing.
- Do NOT let metallic portions of the appliance come into contact with metal sinks or other appliances.

The installation shall be in accordance with the requirements of AS/NZS 3500.1.

Choosing the Right Location

Installing a built-in washing machine

- You need a space at least 60 cm wide.
At least 2 mm of clearance on the sides, and 3 mm of clearance above and behind the appliance are required.
- The counter above the appliance must be firmly fixed to the adjoining cupboards.
- Instead of the standard cover panel, have a technician install a metal cover.

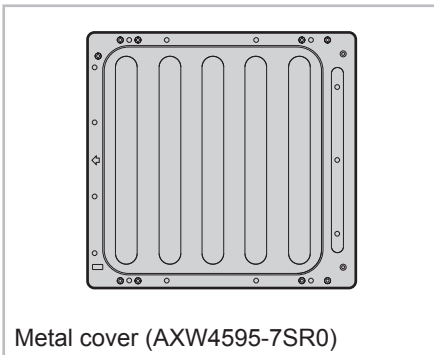
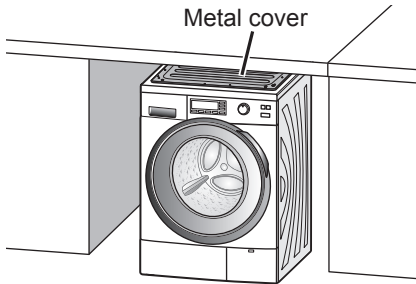

Moving and Installing

Removing the anchor bolts

Four anchor bolts keep the interior of the appliance in place while the appliance is being moved. Remove them before installation, using the spanner that is supplied with the appliance. Follow the following instructions.

Note

The anchor bolts must be removed before the appliance is operated. They may cause excessive vibration.

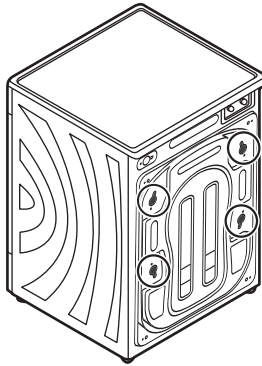

1. Use the 'B' end of the spanner to loosen the four bolts.

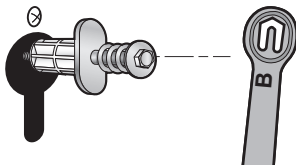

2. Pull the bolts out horizontally.

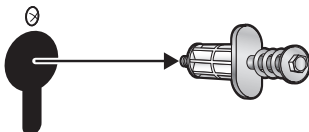

32 - Installation Instructions

3. Remove the screws, which are next to the bolt holes.



4. Push each cover cap (included with the accessories) over each bolt hole, and then secure them with the screws you removed in step 3.

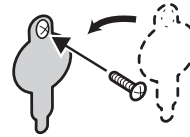

Note

Make sure that you store the anchor bolts, because they are used when transporting the appliance. If the appliance is passed on to another person, make sure to give the anchor bolts to that person.

Moving the appliance

Note

Make sure to install the anchor bolts in the appliance.

Before you move the appliance

- Shut the tap and run the appliance to drain the water. Drain any remaining water from the pump hose. (See page 23.)
- Depressurize the water-supply hose and remove it.
- Disconnect the power cable.
- Install the anchor bolts. (See page 33.)

Moving and Installing

Installing the anchor bolts

1. Unscrew and remove the cover caps.

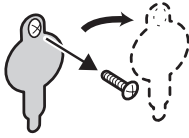

2. Pull the bolts out until their tips are level with the tips of the sleeves.

Have someone else hold the top of the drum and pull it forward.

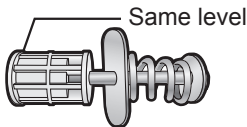

3. Insert the transportation guards.

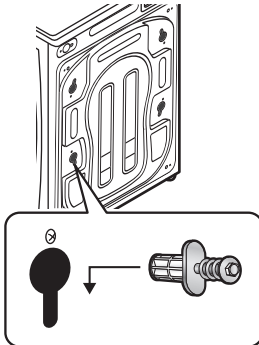

4. Tighten each bolt so that spring extends out by 26 mm.

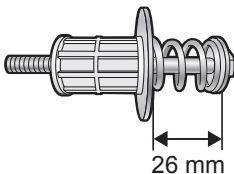
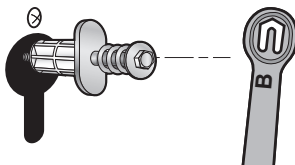

Levelling the appliance

Using a level facilitates the making of adjustments.

To adjust the stands, use the 'A' end of the spanner.

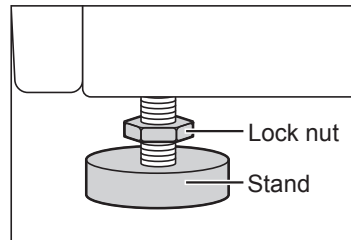
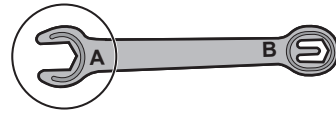

1. On each stand, loosen the lock nut by turning it clockwise.
2. Adjust each stand by turning it clockwise or anticlockwise.
3. Use a spirit level to make sure that the appliance is properly levelled.
4. Tighten each lock nut by turning it anticlockwise.

Caution

Make sure that all lock nuts are tightened securely and the stands are still bolted to the appliance.

If they are unbolted, the appliance will move around.

Connecting Hoses and Power Supply

Follow the instructions in this section to prevent water leaks. If you are unsure, ask a service agent to connect the hoses.

Hoses and cable lengths

Left side connections

Right side connections

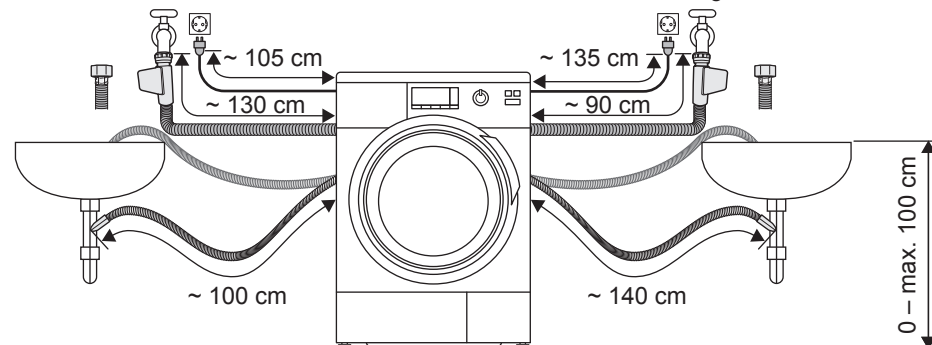

Water-supply hose

Caution

- Do NOT connect the water-supply hose to a combination tap.
- Do NOT twist, squash, modify, or cut the hose.

- Optimum mains water pressure is 0.03 - 1.0 MPa. If the water pressure exceeds this value, install a pressure reducing valve.
- Water-flow from the tap should be more than 5 L/min.

Connecting the water-supply hose

1. Attach one end of the hose to the water inlet on the back of the appliance and tighten the joint by hand.

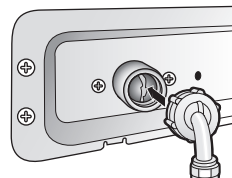

2. Attach the other end of the hose to the tap and tighten it the same way.



Hose with water-supply valve

Standard hose

3. Open the tap slowly and make sure that there are no leaks around the joints.

The joints are subject to water pressure.

Connecting Hoses and Power Supply

Leak-proof System

The appliance is installed with the system that is designed to prevent water leaks. The system includes the following components.

1) Leak sensor

This sensor will cease operation of the appliance if it detects any leaks. It is located on the base plate of the appliance. If a leak has been detected, an error display starting with H, for example, H 01, will appear. In that case, contact your local Customer Service Centre.

2) Overflow detection

If water in the appliance increases to a certain level, this function stops the water supply and activates the drain pump.

Water-drain hose

Caution

Do NOT twist, pull out, or bend the drain hose.

Draining to a sink or wash-basin

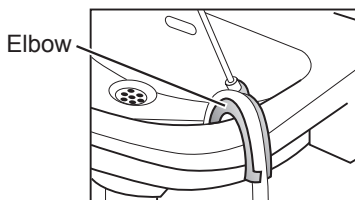

Caution

- Secure the water-drain hose so that it will not come out of the basin.

Caution

- Do NOT block the basin, where the drain outlet is. Make sure that drainage into the drain is sufficient.

- Do NOT let the tip of the water- drain hose dip into the drained water.

This can cause water to flow back into the appliance.

Draining to a drain hose

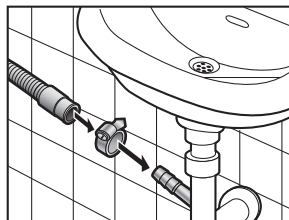

Connecting to the power supply

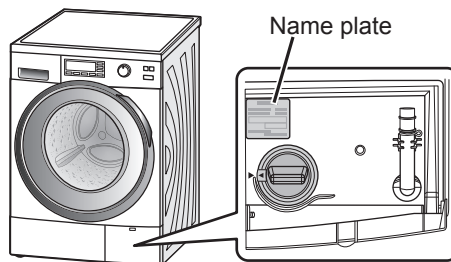

Caution

The name plate indicates the rated power that the appliance needs. Make sure that the power supply specifications in your residence match the information mentioned here.

Checking After Installation

Installation checklist

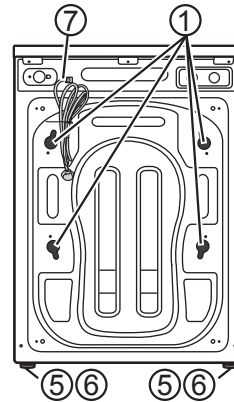
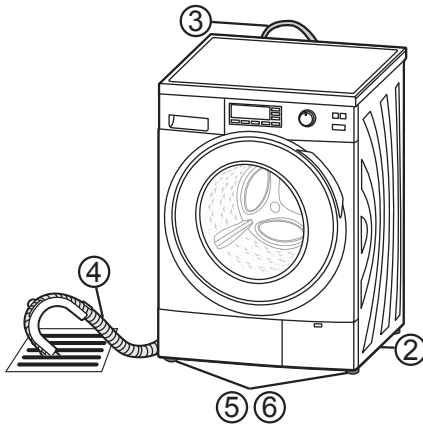

- 1) Anchor bolts
Have you removed them and attached the cover caps properly?
- 2) Location
Is the appliance on a flat, stable surface?
Does it run without vibrating?
- 3) Water-supply hose
Is it free from leaks?
Is the water supply normal?
- 4) Water-drain hose
Is it free from leaks?
Does it drain normally?
- 5) Adjustable stands
Are they bolted securely to the appliance?
- 6) Stand cushions
Are they standing flat?
If the appliance is not level, there may be abnormal sounds when water is drained out.
- 7) Power supply
Is the household dedicated mains socket, fully rated at AC 220 V to 240 V?

Checking After Installation

Test run after installation

Check for water leakage, abnormal noise, and proper drainage.

Perform the following procedures WITHOUT laundry in the drum.

1. Turn on the tap.
2. Close the door.
3. Please spin after moved this washing machine.
Press the On button. You have to select "Quick 50" course and "Spin" mode. Then press the "Start" button. After the water is drained, start a test run.
4. While holding down the Speed/Eco and Easy Ironing buttons, press the On button.



5. When the display appears as below (3 seconds), press the Speed/Eco button.



The remaining time is displayed as below.

0:03

The test is run for about 3 minutes.

Check the following:

- Is there any abnormal noise?
If so, make sure that the appliance is level.
- Is there any water leakage?
If so, make sure that the hoses are properly connected.

You may get the following errors:

U 11











- Are the hoses properly connected?
Is the drain clogged?

U 14

- Have you properly connected the water-supply hose and turned on the tap?

After recovering from an error, reopen and reclose the door to resume the test.

Power and Water Consumption

Programme	Temperature	Additional function	Load	Power consumption	Water consumption	Time (mins)
 Cotton	40°C	—	10 kg	1.05 kWh	80 L	2:04
			8 kg	0.84 kWh	63 L	1:49
	40°C ¹⁾	Eco	5 kg	0.71 kWh	50 L	2:45
			4 kg	0.62 kWh	40 L	2:30
	60°C ¹⁾	Eco	10 kg	0.95 kWh	63 L	3:45
			8 kg	0.68 kWh	50 L	3:30
			5 kg	0.84 kWh	50 L	3:05
			4 kg	0.71 kWh	40 L	2:55
 Cotton Rinse Plus	60°C	—	10 kg	1.55 kWh	87 L	3:02
			8 kg	1.48 kWh	74 L	2:22
	40°C	—	10 kg	0.87 kWh	87 L	2:12
			8 kg	0.85 kWh	74 L	1:57
	40°C	Eco ³⁾	10 kg	0.83 kWh	80 L	3:23
			8 kg	0.67 kWh	68 L	2:53
 Easy-care	40°C ¹⁾	—	5 kg	0.70 kWh	55 L	1:31
			4 kg	0.56 kWh	45 L	1:21
 Wool	30°C	—	2 kg	0.20 kWh	50 L	0:40
 Silk/Lingerie	30°C	—	2 kg	0.22 kWh	60 L	0:40
 Quick 50	40°C ¹⁾	—	5 kg	0.48 kWh	50 L	0:49
			4 kg	0.45 kWh	40 L	0:49
 Rapid 15	30°C	—	2 kg	0.15 kWh	23 L	0:15
 Shirts	40°C	—	2 kg	0.42 kWh	35 L	1:08
 Sportswear	40°C	—	3 kg	0.65 kWh	45 L	1:30
 Outdoor	30°C	—	3 kg	0.27 kWh	58 L	1:48
 Denim	30°C	—	2 kg	0.24 kWh	40 L	0:55

1) Results calculated regarding the Eco function and the maximum spin-dry revolution comply with EN 60456.

2) The power, water consumption, and times indicated in the table may vary depending on variations in pressures, water hardness and temperatures, room temperatures, types and amounts of laundry, voltage fluctuations, and which optional functions are used.

3) Cotton Rinse Plus, 40 deg, Eco, 1400 r/min is for normally cotton soiled load.

Specifications

	NA - 140VG3	NA - 148VG3
Rated voltage	220 - 240 V	
Rated frequency	50 Hz	
Maximum energy rated power input	2000 - 2350 W	
Heating energy rated power input	2000 W (230 V)	
Product weight	74 kg	
Maximum mass of dry cloth	10 kg	8 kg
Product dimensions	596 mm (W) × 625 mm (D) × 845 mm (H)	
Water consumption	Refer to "Power and Water Consumption".	
Pressure of tap water	0.03 - 1 MPa	

Panasonic Corporation
Web Site: <http://panasonic.net>

© Panasonic Corporation 2011



0 0 1 8 2 2

Printed in China

February 2011

W9901-7ZT00