

# Panasonic<sup>®</sup>

## Operating Instructions

### Washing Machine (Household use)

Model No. **NA-16VX1**  
**NA-16VG1**  
**NA-14VA1**



Thank you for buying a Panasonic washing machine.

- These Operating Instructions will help you use it properly and safely.
- In particular, make sure you read the Safety Precautions on pages 4 and 5 before you use your washing machine.
- Complete the guarantee card, including the purchase date and dealer's name, and keep it safely.

# Consider the environment

## ■ Disposing of packaging

The packaging we use to protect the washing machine from damage during transportation is all recyclable. For information on recycling, contact your local authority.

## ■ Disposing of Waste Electrical & Electronic Equipment

### Information on Disposal for Users of Waste Electrical & Electronic Equipment (private households)



This symbol on the products and/or accompanying documents means that used electrical and electronic products should not be mixed with general household waste.

For proper treatment, recovery and recycling, please take these products to designated collection points, where they will be accepted on a free of charge basis. Alternatively, in some countries you may be able to return your products to your local retailer upon the purchase of an equivalent new product.

Disposing of this product correctly will help to save valuable resources and prevent any potential negative effects on human health and the environment which could otherwise arise from inappropriate waste handling. Please contact your local authority for further details of your nearest designated collection point.

Penalties may be applicable for incorrect disposal of this waste, in accordance with national legislation.

### Information on Disposal in other Countries outside the European Union

This symbol is only valid in the European Union.

If you wish to discard this product, please contact your local authorities or dealer and ask for the correct method of disposal.

## ■ Keeping your laundry eco-friendly

- Keep to the load limit of each programme.
- The washing machine automatically adjusts the operating time of each programme depending on the load.
- You only need to use a preliminary wash if your laundry is heavily soiled.
- Using the 60°C Cotton Eco programme instead of the 90°C Cotton one will save energy, and will remove ordinary stains.

## ■ Amount of detergent

- Use the correct amount of detergent based on the detergent pack instructions and local water hardness.
- Adjust the amount of detergent depending on how soiled your laundry is.

## ■ When using a tumble dryer

- To save energy, please select the correct spin-dry revolution speed according to the instruction of your tumble dryer.
- This product complies with the directives 2006/95/EC and 2004/108/EC.

# Contents

## Read before using

Consider the environment .....	2
Safety precautions (Please observe these fully.) .....	4
Know your washing machine .....	6
Before you start washing .....	7
Using the buttons .....	8
How to lock or unlock the door .....	9
How to add detergent and softener ...	10
Selecting the programme .....	12
Power and water consumption .....	13
Details of programmes .....	14

## Using your washing machine

<b>Washing .....</b>	<b>16</b>
<b>Washing delicates .....</b>	<b>18</b>
<b>Washing blankets or bedspreads .....</b>	<b>20</b>

## Various usage

Cleaning the drum .....	22
Preset timer .....	23
Individual washing functions .....	24
Optional functions .....	25
Using your washing machine .....	26
How to set and reset the child safety lock .....	26
How to turn the 'end of programme' buzzer on or off .....	26
How to use laundry starch .....	27
How to use water softening agent .....	27

## Maintenance

Maintenance .....	28
Cleaning your washing machine, detergent drawer, the filter net of the water supply valve, washing machine door seal and window .....	28
Preventing a frozen water supply hose/ Cleaning the drain filter .....	29

## Read when the need arises

Troubleshooting .....	30
Error display .....	32

## How to install

Choosing the right location .....	33
Moving and installing .....	34
Hose and cable lengths .....	36
Levelling the washing machine .....	36
Water-supply hose .....	37
Water-drain hose .....	38
Connecting to the power supply .....	38
Installation checklist .....	39
Checking your washing machine runs properly .....	39
Specifications .....	Back cover

# Safety precautions (Please observe these fully.)

Please read the following instructions to avoid danger to you or your property.

## ■ We have split our safety precautions into two degrees of danger.



**WARNING** This describes issues which could cause death or serious injury.



**CAUTION** This describes issues which could cause injury or damage your belongings.



**WARNING**

- **If you will not be using the washing machine for a while, such as when you go on holiday, turn off the water supply to the washing machine. This is particularly important if there is no drainage around the washing machine.**

If the water supply is left on, water pressure may build up and cause a leak.

## ■ General Use

- **Do not install your washing machine anywhere that is damp or exposed to the weather.**

If you do, it may cause an electric shock, fire, failure or deterioration.

- **Do not pour water directly onto any part of the washing machine.**

It may cause a short circuit or electric shock.

- **Keep burning objects such as candles or cigarettes, away from the washing machine.**

They may cause a fire or damage.

- **Keep flammable substances well away from the washing machine – for example kerosene, gasoline, benzene, paint thinner and alcohol, or clothing soaked with these.**

They may cause an explosion or a fire.

## ■ Power source and cable

- **Use an independent household dedicated mains socket, fully rated at AC 220V to 240V.**

If the washing machine is plugged in with other appliances, it may overheat and cause a fire.

- **Make sure the mains plug is pushed firmly in the socket.**

A loose connection may overheat and cause electrical shock or a fire.

- **Check the mains lead and mains plug for any damage.**

If the supply cord is damaged, it must be replaced by the manufacturer, its service agent or similarly qualified persons in order to avoid a hazard.

- **Unplug the mains lead when cleaning the washing machine.**

- **Do not touch the mains lead or mains plug with wet hands.**

It may cause an electric shock.

- **Check the mains plug regularly for dirt.**

If dirt accumulates on the mains plug, it could cause a fire. To prevent this, unplug the cable and clean the mains plug with a dry rag.

## ■ To Prevent Injury

- **Do not dismantle, repair or modify the washing machine.**

The washing machine could malfunction and cause a fire or injury. If repairs are needed, contact our dealer.

## **WARNING**

- **This appliance is not intended for use by persons (including children) with reduced physical, sensory or mental capabilities, or lack of experience and knowledge, unless they have been given supervision or instruction concerning use of the appliance by a person responsible for their safety.**
- **Children should be supervised to ensure that they do not play with the appliance.**
- **Do not touch the laundry inside the washing machine, until the drum has completely stopped.**

Even if the drum is spinning at low speed it can cause an injury. Take particular care of children in this respect.

## **CAUTION**

### ■ **General Use**

- **This washing machine is only suitable for washing textiles labelled washing machine-washable.**
- **Anchor bolts are used to transport the washing machine. You should remove these using a spanner or similar tool before you install the washing machine.**  
If you do not, it will cause strong vibrations when the washing machine is spinning.
- **Do not connect the washing machine to hot water.**  
The washing machine works with cold water.
- **Before you start using the washing machine, turn the tap on to check that the hose is properly connected.**  
If it's not, there may be a water leak.
- **Do not apply pesticide, hair spray or deodorant to the washing machine.**
- **Do not put any electrical equipment near the washing machine – for example a TV, radio or battery charger.**
- **Do not put too much laundry or detergent into the washing machine.**  
It may cause washing machine troubles.
- **Be careful not to get your laundry caught in the door when you close it.**  
This could cause a water leak or damage to laundry.

### ■ **Power source, Mains lead**

- **If you disconnect the mains plug, hold onto the mains plug not the cable.**  
Pulling the cable may cause an electric shock or a fire.
- **Do not use a mains plug adaptor or extension cable.**  
It may overheat and cause a fire.
- **Make sure your home voltage matches the voltage displayed on the washing machine. If you are not sure, contact an electrician.**

### ■ **To Prevent Injury**

- **Do not climb on the washing machine.**  
You may hurt yourself or damage the washing machine.
- **When opening and closing the door ensure you keep fingers away from the door hinge, or this could lead to injury.**
- **Check your washing for objects such as nails, pins, coins, clips etc.**  
They could damage your laundry or the washing machine.
- **Do not wash, rinse or spin water-proof sheets or clothing.**  
These may cause vibration or washing machine failure during spin-drying, which could lead to injury, damage to the washing machine or damage due to water leaking.
- **Be careful when draining hot water or any detergent from the drum.**  
To prevent an injury.

# Know your washing machine

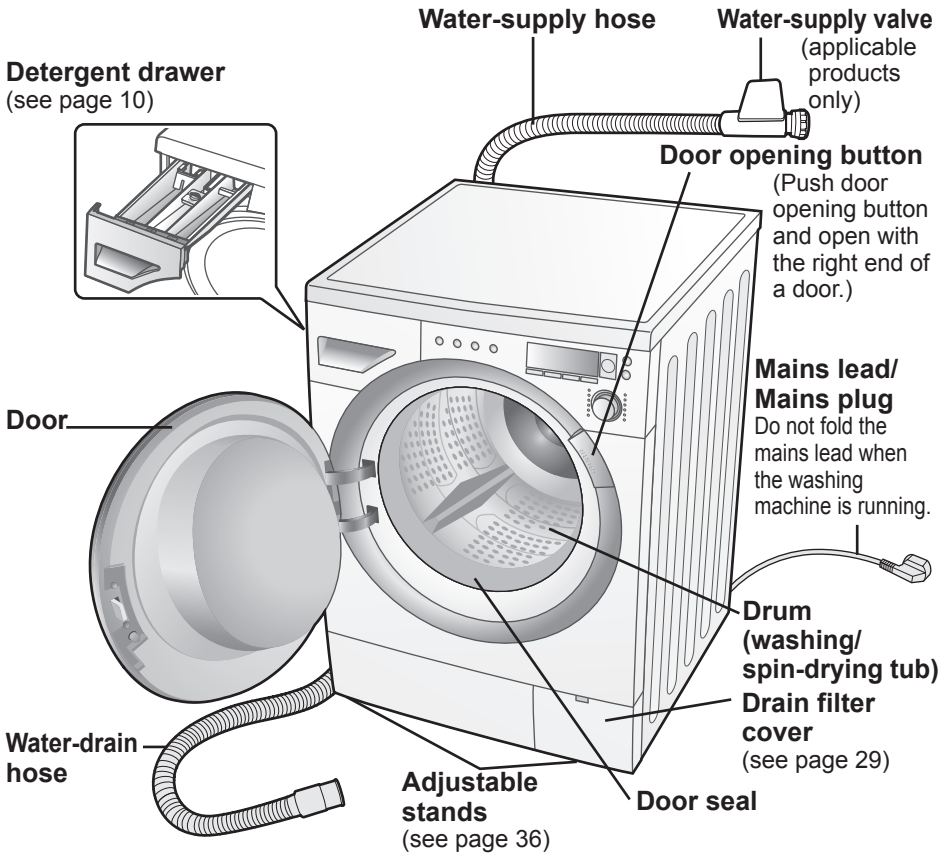

## Check before using

- 1 **Secure the Water-supply hose.**
- 2 **Open the tap.**

**Caution**  
After finishing, turn the tap off.

- 3 **Connect the power.**
- 4 **Make sure the drain hose flows to a drain.** (see page 39)

## Accessories

- **Cover cap (x4)** (see page 34)



- **Spanner** (see pages 34, 36)  
(End A is for adjusting the stand  
End B is for the anchor bolts)



- **Elbow** (see page 38)  
For fixing the Water-drain hose

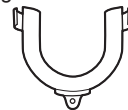

# Before you start washing

Water is poured into the Washing machine to perform an inspection at the time of shipment from the factory, so there may be drops of water or condensation in the Washing machine. This is not an indication of a malfunction.

## Before the first use

### Do not put anything into the washing machine.

Cotton 40 °C programme is the default setting. Run the washing machine for the first time without any detergent or clothing to rinse out any residue or moisture.

## Organizing laundry

- Read the washing label on each garment to help you sort your washing into different loads.
- Sort the laundry by colour, type of fabric and by how soiled it is. This will help you choose the correct programme and temperature for each wash.

## Preparing the laundry

### Treating stains before washing

#### • Collar and sleeve

Apply stain remover to the stained parts of collars and sleeves.



#### • Spots

Apply appropriate stain remover to spots.



#### • Dirt and solid stains

Apply stain remover or special soap to stains such as curry, tomato sauce and plant dye, then wash lightly by hand first.



### Items to be put into a cleaning net before going into the washing machine

- Bras with metal wires, tights and lace clothing should all be washed in a cleaning net to prevent damage.

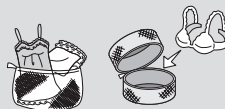

### Checking clothing

- Check that any pockets on clothing do not contain any objects which may damage your clothes and washing machine.



- Tie up any loose strings on laundry, close zippers and reverse clothing with the zip inside out.



They may cause damage to clothing.

- Clothes that are not colour fast should be washed separately.



Sort other clothes by colour, with denim kept separate.

- Remove any surplus hair, animal fur, sand, and other materials with a brush before washing.



- If clothes have raised fabrics turn them inside out.



- Apply softener before you start washing to prevent static.



Read before using

Know your washing machine  
Before you start washing

# Using the buttons

## Optional functions

- You can add functions to each basic programme to suit your laundry needs.
- Some functions don't apply to certain programmes. (see pages 14-15, 25)

## Temperature

- Lets you choose the wash temperature from cold to 90°C. For example, you may prefer a hotter wash for whites, cotton, or soiled laundry.
- Some temperatures can't be used for certain wash programmes. (see pages 14-15)

## Progress indicator

- Tells you how far through each cycle your washing is.  
\* on model NA-16VX1 only.



\*Example shows display when fully lit.



## Spin speed

- Shows the spin speed (in rpm) for the programme you've selected.
- You can choose your own spin speed for some programmes.
- Some spin speeds can't be used for certain programmes.

## Presets

- You can choose when your programme finishes. (see page 23)

## Process indicator



- Shows you the current stage of the programme, i.e. wash, rinse spin or drain.
- When the light is out, the programme has finished. (see page 24)

## Programme selection dial

- Use this to choose the best programme for your laundry. (see page 12)

Example) Display on NA-16VG1

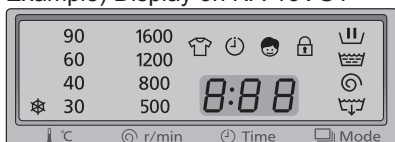

\*Example shows display when fully lit.

Example) Display on NA-14VA1

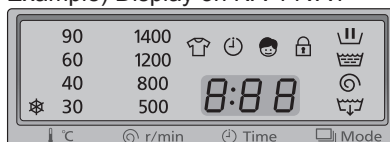

\*Example shows display when fully lit.

## Caution

- When a programme is running, you can't add optional functions to it or change the wash temperature.
- To change the programme, turn the washing machine off and on again.
- To change optional functions, such as rinse settings or spin speed, press the PAUSE button after water has been added to the drum.
- You'll hear the buzzer when you press the buttons, to help make sure you've chosen the right settings.



### Remaining time indicator

- Tells you roughly how long until the programme ends.
- Detects the weight of the laundry when the programme starts and gives an approximate time for your chosen programme to run. (≥ ≤ flashes during detection.)  
For example 1:18=1 hour and 18 minutes
- \*The time shown is only an estimate. How long the programme actually takes may differ according to the amount and type of laundry, the pressure of the water supply and drainage conditions.

### Start/Pause

- Press this button to start or pause your wash programme.

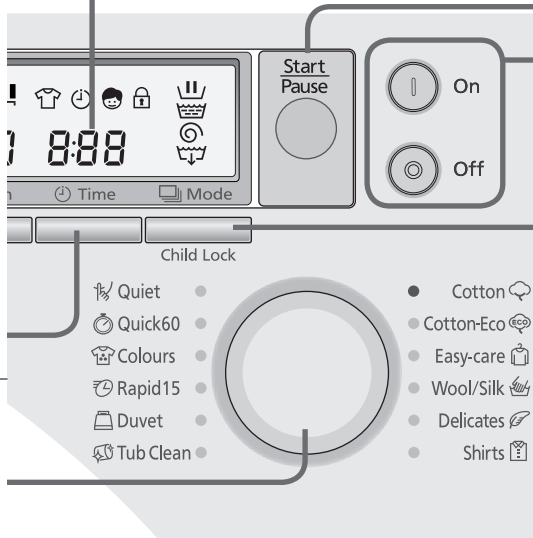

\* Example) Display on NA-16VX1

### Power buttons

- When the washing machine is switched on, if after ten minutes you haven't pressed the START button, the washing machine automatically switches itself off.
- If the washing machine is off, and you see this display, you can't turn the washing machine back on again until the display goes off.



### Mode selector

- Use this to select additional functions for each programme, such as rinsing and spin cycles, and for the Drain only function.

### Child safety lock

- Use this to lock the door and prevent children climbing into the drum.
- It also locks the controls to prevent children starting or stopping programmes accidentally. (see page 26)

## How to lock or unlock the door

The door is automatically locked while any programme is running.  sign is shown while the door is locked.

\*The door normally clicks when it locks or unlocks.

#### Caution

- Switching the washing machine off at the plug doesn't unlock the door.
- If the door is locked and you switch the washing machine off – or if there's a power cut – it will stay locked until you turn it back on again.
- \* This is different from the child safety lock. (see page 26)

To unlock the door while a programme is running

During operation

Press the START button.



After the drum stops spinning, the door will automatically unlock and will be signaled with a clicking sound. This can take about a minute.

\* If you have to unlock the door mid-programme, try to make sure you don't flood the floor with water from the drum.

# How to add detergent and softener

- Pull out the detergent drawer and add detergent or softener to the correct compartment.
- Only use detergents recommended for fully-automated washing machine. Refer to the instructions on the packaging for appropriate amounts to use for different wash programmes.

## Liquid detergent

Add detergent to the relevant compartment in the drawer:

- ① **Liquid detergent**
  - Don't use for Prewash programmes. (see page 25)
- ② **Liquid mild detergent**
  - Use for Wool wash programmes.

## Powdered detergent

- If you forget to add detergent, you can drain the washing machine by running a Drain only function, using the MODE button. Then you can add detergent and start the programme again. (Detergent only reaches the drum when water flushes through the detergent drawer).
- To prevent powdered detergent staying in the drawer:
  - Dry the inside of the drawer with a cloth.
  - Make sure the powder isn't lumpy when you add it.

## How much detergent do I use?

This can depend on:

### 1. How soiled your laundry is

- Light soil – no visible stains or marks
- Normal – light stains and marks visible
- Heavy soil – large or ground-in stains and marks

### 2. The amount of laundry

### 3. Water hardness

You can find out more about water hardness in your area by calling your local water authority.

- If the rinse cycle isn't removing all the detergent from your wash, use less detergent or try the Extra Rinse function.

Add tub cleaning detergent or bleach to this compartment.

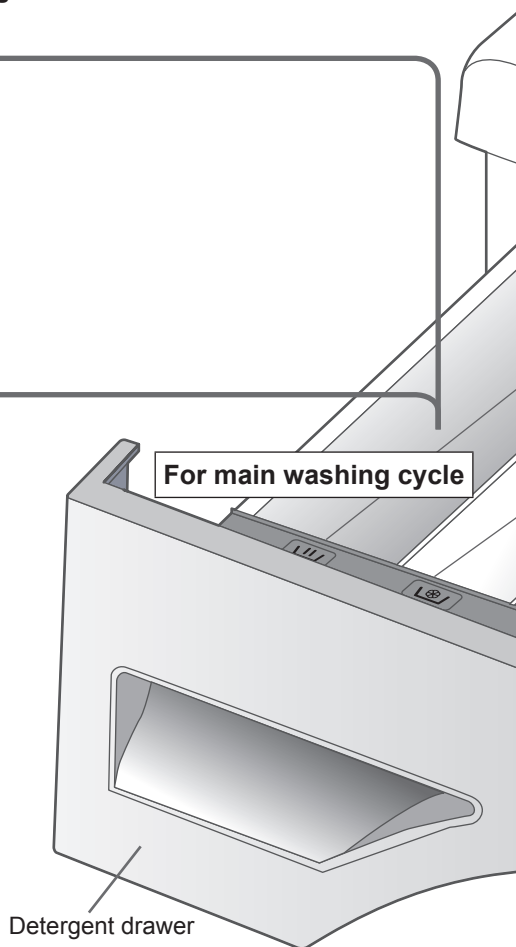

## Softener

**Add softener before you start the programme – the washing machine automatically adds it to the final rinse cycle.**

- Dilute concentrated softeners before you add them. Only add up to 130 ml to the compartment to avoid over-flowing.

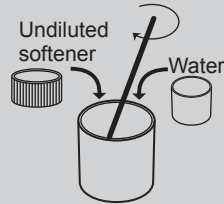

Softener should not exceed the MAX level in the compartment.

- \* Wash out unused softener with a splash of water or a damp cloth after the programme has finished. If it sticks in the compartment put out the drawer and clean it up. (see page 28)

## For prewash cycles

## Water softening agent

You can soften water in hard water areas by adding water softener. Always check the packaging for the appropriate amount to use. And always add your water softener after your detergent.













## Note

- Foaming varies according to the amount and type of detergent you use, as well as how soiled the laundry is, and the hardness and temperature of the water.
- When opening the door mid-operation, water and foams droplets may fall from the door and the door hole. In this case, you may require a towel to be used to catch any of them if necessary.









## Detergent for prewashing

- Always put prewash detergent in this compartment when you select programmes with prewash cycles.

# Selecting the programme

Programme	Description	Max load
 <b>Cotton</b>	Daily washing for cotton, linen and cotton blend. (e.g. T-shirts, underwear, towels, tablecloths)	<b>7 kg</b>
 <b>Cotton-Eco</b>	Cotton, linen and cotton blend - takes longer but uses less water and power than Cotton programme.	<b>7 kg</b>
 <b>Easy-Care</b>	Gentle on cotton, linen and man-made materials.	<b>3.5 kg</b>
 <b>Wool/Silk</b>	Gentle washing for hand and washing machine washable wool, silk and wool blend clothing.	<b>2 kg</b>
 <b>Delicates</b>	Gentle wash for synthetic fibre, textiles, satin, lace, etc.	<b>3.5 kg</b>
 <b>Shirts</b>	Shirts and blouses.	<b>2 kg</b>
 <b>Quiet</b>	May take longer than Cotton programme, but less noise.	<b>7 kg</b>
 <b>Quick 60</b>	Washes lightly soiled clothing quickly.	<b>3.5 kg</b>
 <b>Colours</b>	Separate wash for coloured cotton or cotton blend items. (e.g. T-shirts, pyjamas, trousers)	<b>3.5 kg</b>
 <b>Rapid 15</b>	Washes a few lightly soiled items in 15 minutes.	<b>2 kg</b>
 <b>Duvet</b>	Washes large items such as blankets, curtains and bedspreads.	<b>3 kg</b>
 <b>Tub Clean</b>	Cleans the drum.	<b>—</b>

# Power and water consumption













Programme	Temperature	Optional function	Max load	Power consumption <sup>2)</sup>	Water consumption <sup>2)</sup>	Time <sup>2)</sup>
 <b>Cotton</b>	40 °C <sup>1)</sup>	Intensive	7 kg	0.84 kWh	65.0 L	1:47
	40 °C	—	7 kg	0.80 kWh	65.0 L	1:27
	60 °C	—	7 kg	1.57 kWh	75.0 L	1:32
	90 °C	—	7 kg	2.09 kWh	85.0 L	1:52
 <b>Cotton-Eco</b>	60 °C <sup>1)</sup>	Intensive	7 kg	1.04 kWh	44.0 L	2:30
	60 °C	—	7 kg	1.00 kWh	44.0 L	2:20
 <b>Easy-Care</b>	40 °C <sup>1)</sup>	Intensive	3.5 kg	0.53 kWh	52.0 L	1:15
 <b>Wool/Silk</b>	30 °C	—	2 kg	0.25 kWh	50.0 L	0:40
 <b>Delicates</b>	40 °C	—	3.5 kg	0.60 kWh	62.0 L	1:00
 <b>Shirts</b>	40 °C	—	2 kg	0.60 kWh	55.0 L	0:50
 <b>Quiet</b>	40 °C	—	7 kg	0.70 kWh	65.0 L	1:38
 <b>Quick 60</b>	40 °C <sup>1)</sup>	—	3.5 kg	0.42 kWh	42.0 L	0:58
 <b>Rapid 15</b>	30 °C	—	2 kg	0.15 kWh	37.0 L	0:15

- 1) Results calculated regarding Intensive Wash and the maximum spin-dry revolution comply with EN 60456.
- 2) Power, water consumption and time shown here may differ due to variations in water pressure, hardness and temperature, room temperature, type and amount of laundry, voltage fluctuation and selection of additional functions.

Read before using

Selecting the programme  
Power and water consumption

# Details of programmes

Programme	Max load	Auto setting			
		Temperature	Number of rinses	Spin-dry revolutions	Approximate time
				16VX1, 16VG1, 14VA1	
 Cotton#	7 kg	40°C	2	1200	1:07 - 1:27
 Cotton-Eco#	7 kg	40°C	2	1200	1:10 - 1:30
 Easy-Care#	3.5 kg	40°C	2	800	0:56 - 1:00
 Wool/Silk	2 kg	30°C	3	500	0:40
 Delicates	3.5 kg	40°C	2	800	0:55 - 1:00
 Shirts#	2 kg	40°C	2	500	0:50
 Quiet	7 kg	40°C	2	500	1:18 - 1:38
 Quick 60	3.5 kg	40°C	2	1200	0:53 - 0:58
 Colours#	3.5 kg	40°C	2	1200	1:07 - 1:27
 Rapid 15	2 kg	30°C	1	800	0:15
 Duvet#	3 kg	30°C	2	800	1:00
 Tub Clean	—	40°C	3	800	3:31

## ■ For the best washing performance

\* When washing the maximum load for wash programmes marked with #, we recommend selecting the "intensive" option to ensure the best washing performance

## ■ Speed of spin-dry revolution

● Effective rinsing of clothes may not be possible at lower spin speeds depending on the amount of laundry or type of detergent used. If this is the case, please use the Extra Rinse function.

## ■ Time required

- The actual times may differ slightly from those shown.
- Time shown includes time needed for filling and draining water, and so depends on water pressure, drain condition and amount of laundry.
- Changing the functions during the programme may change time shown.

- Times depend on programme and temperature settings selected.
- Times may be longer if the laundry in the drum needs to be balanced.

Temperature	Switch setting			Optional functions			
	Spin-dry revolutions			Intensive	Extra Rinse	Prewash	Easy Ironing
	16VX1	16VG1	14VA1				
Cold - 90°C	400 - 1600	500 - 1600	500 - 1400	○	○	○	○
Cold - 60°C	400 - 1600	500 - 1600	500 - 1400	○	○	○	○
Cold - 60°C	400 - 1200	500 - 1200	500 - 1200	○	○	○	○
Cold - 40°C	400 - 500	500	500	○	○	—	—
Cold - 40°C	400 - 800	500 - 800	500 - 800	○	○	○	○
Cold - 60°C	400 - 800	500 - 800	500 - 800	○	○	○	○
Cold - 60°C	400 - 500	500	500	○	—	—	—
Cold - 60°C	400 - 1600	500 - 1600	500 - 1400	○	○	○	○
Cold - 40°C	400 - 1600	500 - 1600	500 - 1400	○	○	○	○
Cold - 30°C	400 - 800	500 - 800	500 - 800	—	—	—	—
Cold - 40°C	400 - 800	500 - 800	500 - 800	○	○	—	○
40°C	800	800	800	—	—	—	—

### ■ Changing programmes while operating

- To change the programme or temperature setting you will need to switch the washing machine off and then on again.
- If you want to change the rinse or spin options during washing, press the Pause button once the washing machine is full of water. You cannot change it after the Wash operation has finished.

### ■ It is not abnormal although clothing sticks to a drum easily depending on the kind of clothing, and programmes.

- Although Cotton-Eco course tends to stick to surface, it is not failure.

# Washing

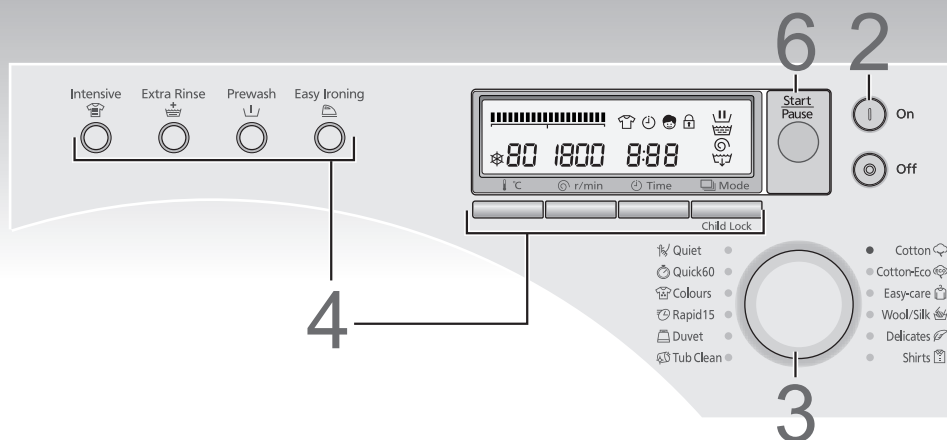

**1** Press the door opening button, and put the laundry in the drum.

■ See pages 7, 12 for sorting your laundry before it goes into the drum.

Make sure no washing gets caught in the door.

**2** Close the door and push the ON button.



**3** Turn the programme selection dial either way to select your wash programme.

■ A wash time will be displayed.

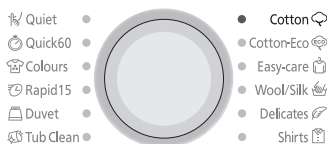

**4** Select any optional functions.

■ Process selection (see page 24)

■ Optional functions (see page 25)

■ Temperature (see page 8)

■ Spin speed (see page 8)



## 5 Add detergent into the detergent drawer.

(see pages 10-11)

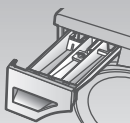

- The quantity of detergent will depend on the amount of laundry, the degree of soiling and the water hardness. Use the amount of detergent suggested on the packaging.

## 6 Press the START button.

- It starts water supplying.

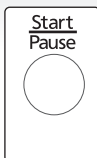

- Once you have started the washing machine, it weighs the laundry. After a delay of about five seconds it then displays a new wash time. While the laundry is being weighed the  mark flashes. If you select the Wool/Silk, Duvet, Rapid 15, Shirt or Tub Cleaning programme, the wash is not weighed.

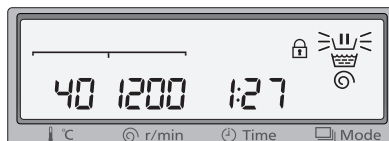

\* Example) NA-16VX1 Cotton programme display



**The buzzer will sound when the programme is complete.**

- With the Easy Ironing setting, the drum intermittently stirs laundry for up to 30 minutes or until the door is opened. (see page 25)

- **Once the wash has started, the programme, temperature and preset time cannot be changed.**

If you need to change a setting, turn the power off and then on again. Re-select the programme, process, temperature and preset time, and then press the START button.

- **Settings you can change mid wash**

You can change the Spin-dry Revolution, Extra Rinse and Easy Ironing function during the wash.

You cannot change the programme once the rinse cycle has started.

# Washing delicates

(Wool/Silk and Delicates programmes)

\*These programmes rock the drum gently for best results on delicate laundry.

## ■ Delicate laundry loads:

- Wool/silk – 2kg or less : Delicates – 3.5kg or less

## ■ Tips for Wool/Silk programme:

- Approximate weights:

Wool sweater  
400g



Silk blouse  
200g



Trousers  
400g



## <Adding delicate laundry items to the drum>

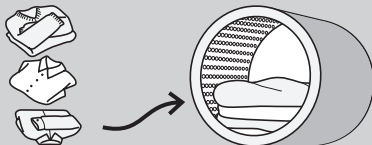

- Close zips and buttons.
  - Add items one by one on top of each other.
- \* Don't overload the drum – it may cause excessive vibration or damage to the washing machine.

## • Which detergent to use



- For wool items, use a mild liquid detergent. Other detergents may damage your clothes.
- With Wool/Silk and Delicates programmes, you may need to use the Extra Rinse cycle to remove excess detergent from your clothes. This depends on the amount of detergent you use, and the amount of foam that develops in the main wash cycle.
- To do this, once the programme has finished, select the Wool/Silk programme to rinse again. Then select Rinse using the MODE button and press START.

## ■ Tips for hanging delicate items to dry

- Hang white or light-colour clothes, wool and nylon away from direct heat or sunlight.
- After washing, smooth creases and folds out of wool and nylon clothes, and return them to their normal shape before hanging in the shade.  
(This saves ironing too.)

Hang wool items without folds or creases.



Use a hanger for shirts, blouses and trousers.



You can wrap a towel round the hanger to fit the shoulder width of your clothes, so they retain their shape as they dry.



Spread woollen items such as sweaters out to dry.

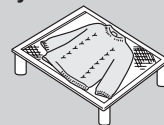

## • If clothing shrinks in the wash

Spread the item out to its original size on an ironing board, and use dress pins to hold the size and shape. Then use an iron to steam the item and leave it to dry.



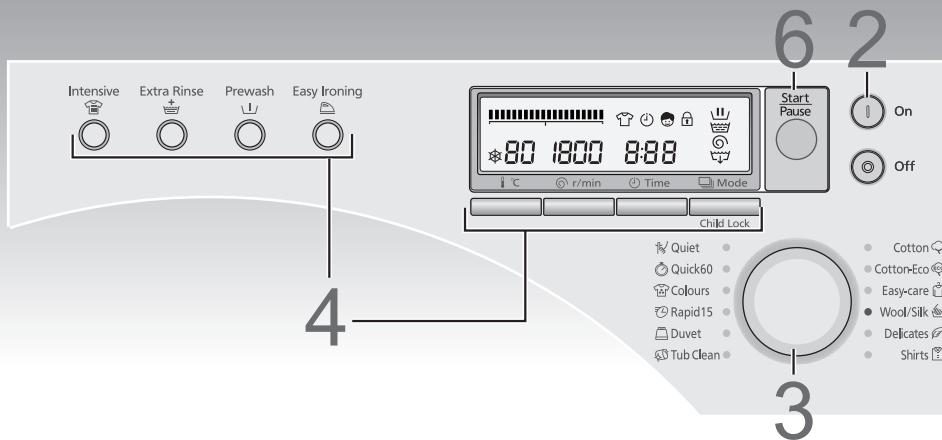

**1** Press the door opening button to open the door and add laundry to the drum.

**2** Close the door and press the power  On **ON** button.

**3** Turn the programme selection dial and select the **Wool/Silk** or **Delicates** programme.  
 ■ The display will tell you approximately how long the programme will take.

**4** Select any optional functions.

**5** Add detergent to the drawer.  
 (see pages 10-11)

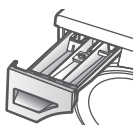

**6** Press the **START** button.  
 ■ It starts water supplying.

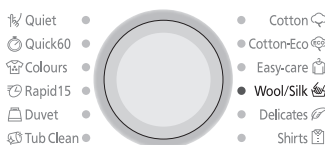
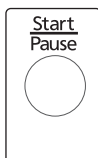

- Process selection (see page 24)
- Optional functions (see page 25)
- Temperature (see page 8)
- Spin speed (see page 8)

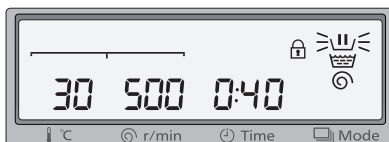

\* Example) Display on NA-16VX1



**The buzzer will sound when the programme is complete.**

- Remove your laundry and rearrange its shape where necessary.  
 Try not to leave it in the drum for long after the programme ends – colours may run.

**Caution**

- If your clothing floats in the Wool/Silk programme, press the PAUSE button to open the door. Press the floating items down lightly, and re-start the programme.

# Washing blankets or bedspreads

(Duvet programme)

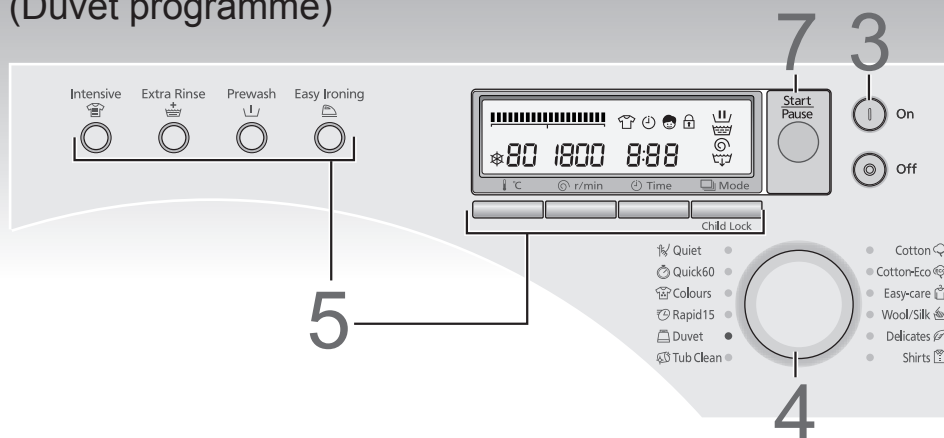

■ Make sure the label of each item to be washed shows either the wash or hand-wash symbol (☹, ☹☹).

Washable	<b>Blanket</b>
	<ul style="list-style-type: none"> <li>• 100% synthetic fibre blanket – up to 3kg</li> <li>• 100% cotton blanket – up to 1.5kg (single bed size)</li> </ul>
	<b>Other</b>
	<ul style="list-style-type: none"> <li>• Futon (100% synthetic fibre) – up to 1.5kg (single bed size)</li> <li>• Sheets</li> <li>• Bedspreads</li> <li>• Undersheets (100% synthetic fibre)</li> </ul>
Non-washable	<b>Blanket</b>
	<ul style="list-style-type: none"> <li>• 100% wool</li> <li>• Long-piled blanket</li> <li>• Electric blanket (including cover)</li> </ul>

### Caution

- Don't wash waterproof covers or clothes, or items without the correct symbols on the label.

## 1 Fold blanket or bedspread.

■ Fold into four, like so:

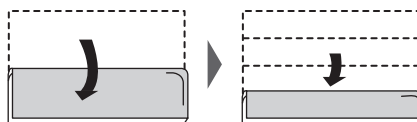

## 2 Put the blanket or bedspread to the drum.

Fold it into six and add to the drum:

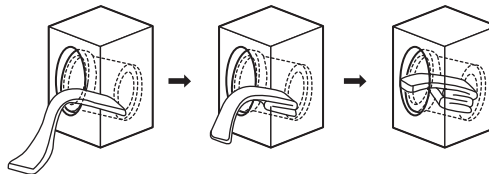

- Putting blankets or bedspreads like this protects your laundry.
- Avoid using 'blanket nets' – they prevent the laundry from spinning properly.
- Wash only one blanket at a time.

### Caution

- Avoid rolling the blanket or bedspread into a ball or folding it randomly. This can cause excessive vibration and damage your laundry or the washing machine.

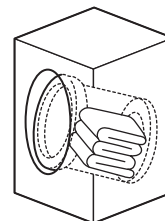

(Always fold and put the item to the drum as shown. Both ends of blanket should be directed inward the drum.)

**3** Close the door and **press the power ON button.**



**4** Turn the Programme Selection dial either way and **select the Duvet programme.**

■ The display will tell you approximately how long the programme will take.

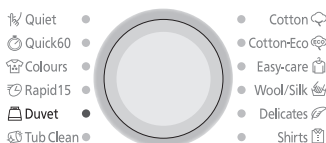

**5** Select any optional functions.

- Process selection (see page 24)
- Optional functions (see page 25)
- Temperature (see page 8)
- Spin speed (see page 8)

**6** Add detergent to the drawer.

(see pages 10-11)

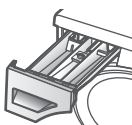

**7** Press the **START** button.

■ It starts water supplying.

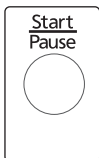

The buzzer will sound when the programme is complete.

# Cleaning the drum

(Tub Clean programme)

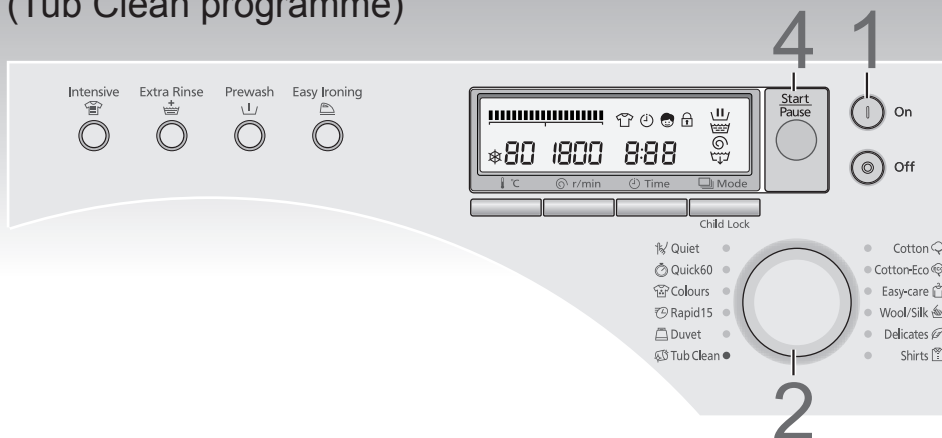

■ If you keep using cold water in your washing machine, this may cause a build-up of bacteria inside the drum, which can give off an odour. You can avoid this by running the Tub Clean programme once a month. (When you use a scale remover, follow the manufacturer's instructions.)

**Important: don't put laundry in the washing machine during 'Tub Clean'.**

**1** With no laundry in the drum, press the power ON button.



**2** Turn the programme selection dial either way to select Tub Clean. ■ The remaining time will be displayed.

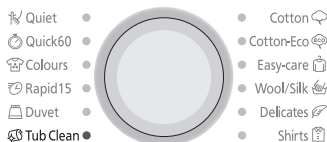

**3** Put tub cleaning detergent and bleach into the detergent drawer. (see pages 10-11)

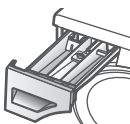

**4** Press the START button. ■ It starts water supplying.

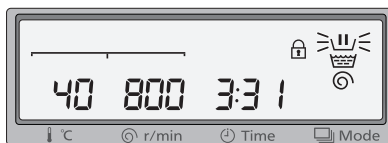
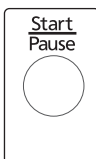

It starts water supplying



The buzzer will sound when the programme is complete.

# Preset timer

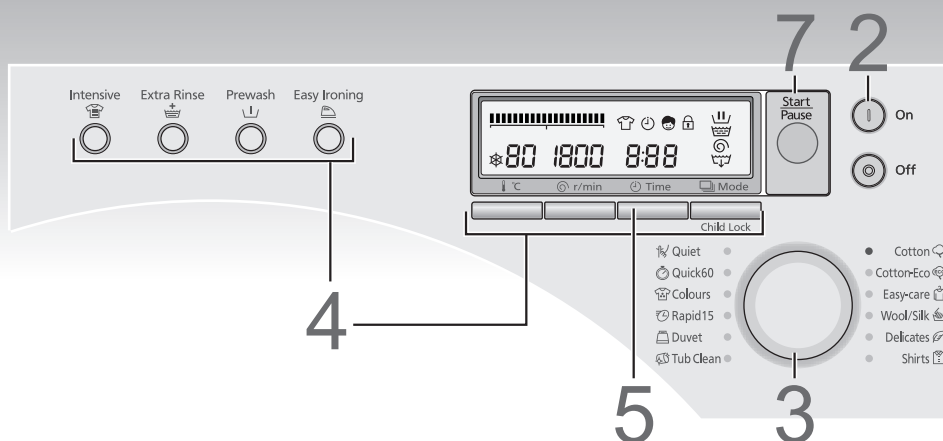

## Preset timer

You can use the timer to set the washing machine to finish running at a specific time.

### <Points to remember>

- You need to choose the programme first, and then preset the time.
- You can't preset the Wool/Silk, Tub Clean programme.
- The washing machine may finish earlier or later than the preset time, depending on the type of laundry and the conditions of temperature, water supply and drainage.
- Do not use hardly dissolvable detergent with the preset function, as other types may cake before the wash starts.

### ■ To change a preset time

- Press the power OFF button, then the ON button, and start again from step 3 above.

### ■ To cancel a preset time

- Press the power OFF button.

### ■ To check a preset time

- Press the TIME button.

- 1 Press the door opening button to open the door. Put your laundry in the drum.
- 2 Close the door, and press the power ON button.
- 3 Turn the programme selection dial either way to select a programme.
- 4 Select any other functions you want.
  - Process selection (see page 24)
  - Optional functions (see page 25)
  - Temperature (see page 8)
  - Spin speed (see page 8)
- 5 Set the time you want your washing to finish.
- 6 Put detergent and softener into the detergent drawer. (see pages 10-11)
- 7 Press the START button.



The buzzer will sound when the programme is complete.

# Individual washing functions

(Process selection)

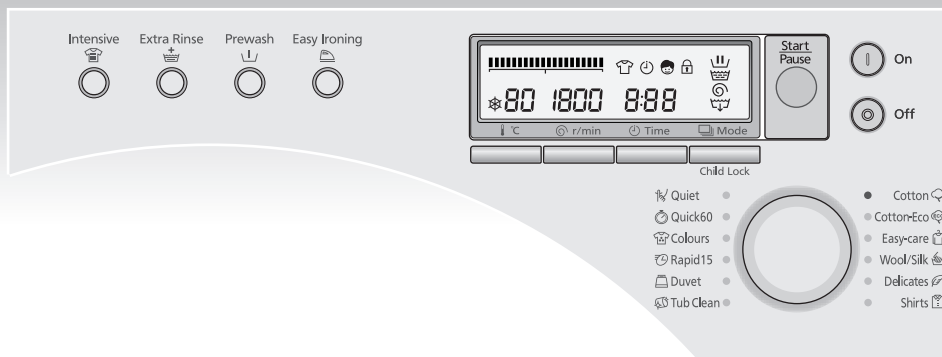

■ You can select either single function such as “Spin only,” “Rinse only” or “Drain only,” or more than one combined washing functions such as “Washing,” “Rinse” and “Spin.”

■ Please note: you can’t select individual functions on the Rapid 15 programme.

■ Press the **MODE** button to select a function.



Function	Display	When you want to:
Rinse only		<ul style="list-style-type: none"> <li>• Rinse washed laundry (Rinse water remains)</li> </ul>
Spin only		<ul style="list-style-type: none"> <li>• Spin-dry washed laundry</li> </ul>
Wash - Rinse		<ul style="list-style-type: none"> <li>• Wash and rinse laundry (Rinse water remains)</li> </ul>
Rinse - Spin		<ul style="list-style-type: none"> <li>• Rinse and spin-dry washed laundry</li> </ul>
Drain only		<ul style="list-style-type: none"> <li>• Drain water from the drum</li> </ul>

- When you start the washing machine, the display flashes to confirm the function is in progress.
- Once the washing machine has started, you can't change the programme.
- With the Rinse only or Spin operation, the washing machine start from Drain if water is in the drum, and starts from Spin if water is not in the drum.





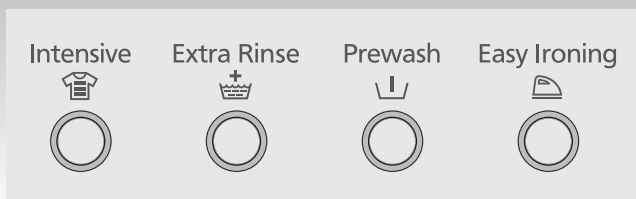

# Optional functions



■ Depending on the programme you select, you can combine different optional functions.

■ Press the function button(s)  you want.

Optional function	When you want to:	How it works
 <b>Intensive</b>	Wash heavily soiled laundry	It increases washing time for 10 to 20 minutes.
 <b>Extra Rinse</b>	Rinse your laundry more thoroughly	It adds an extra rinse cycle.
 <b>Prewash</b>	Prewash heavily soiled laundry	It adds a prewash cycle.
 <b>Easy Ironing</b>	Make ironing easier	<ul style="list-style-type: none"> <li>• It spin-dries your laundry more gently (at 800rpm or less).</li> <li>• This reduces wrinkles and helps unravel tangled laundry.</li> <li>• The drum also rotates the laundry intermittently for up to 30 minutes after the washing machine has finished.</li> </ul>

- The selected button(s)  start flashing – with Prewash and Easy Ironing, they keep flashing while the washing machine is running.
- You can turn the Extra Rinse and Easy Ironing functions on or off during the wash stage, but not once it has finished.

■ You can't select some optional functions with some programmes (see pages 14-15)

If you select an unavailable function, and error alarm will sound.

# Using your washing machine

## ■ How to set and reset the child safety lock

The child safety lock prevents children climbing into the washing machine drum and getting trapped. It keeps the door closed and locked even when the washing machine is not in use.

It also locks the control buttons.

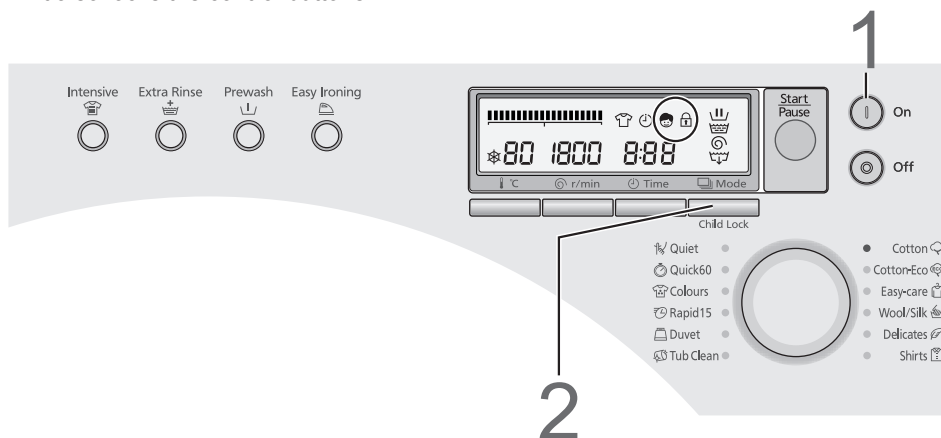

**1** Switch the washing machine on.

**2** Press and hold the **MODE** button for five seconds or more.  
(The sign   lights to confirm the child safety lock is active.)

• Press the button in the same way to unlock. (The sign goes off.)

## ■ How to turn the 'end of programme' buzzer on or off

**1** Press the **START** and power **ON** buttons at the same time,

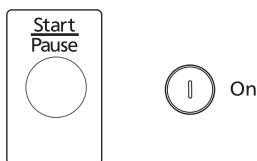

**2** and keep pressing the **START** button for at least three seconds.

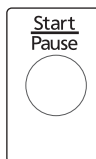

You'll hear the buzzer sound to confirm the buzzer is switched on or off.

• To enable the buzzer to sound, repeat step 1 and 2.

## ■ How to use laundry starch

Laundry starch makes your clothes crisp in texture.  
Synthetic laundry starch is a stiffening agent.

- To use laundry starch, simply add it to the softener compartment, next to where you add detergent. It will automatically be applied to your clothes as part of the final rinsing cycle. (see pages 10-11)
- If it's hard to pour, you can dilute the starch slightly with water before adding it to the softener compartment. Make sure you don't fill the compartment over the MAX level.

(Note)

- After using starch, clean the detergent drawer, especially the softener cover. (see page 28)
- After using starch, to remove any excess starch in the drum, run a Rapid 15 programme without detergent.

## ■ How to use water softening agent

- Hardness of water

Local hardness	Water quality	Total hardness (mmol/l)
I	Soft	0 - 1.3
II	Middle	1.3 - 1.5
III	Hard	2.5 <

- In areas II and III, you can save detergent by adding a water softener. For the correct dose, read the instructions on the packaging.
- Add water softener after detergent to the main wash compartment. If you use other treatments like fabric softener or stain remover, add them to your wash in the following order:  
1. Detergent 2. Water softener 3. Stain remover

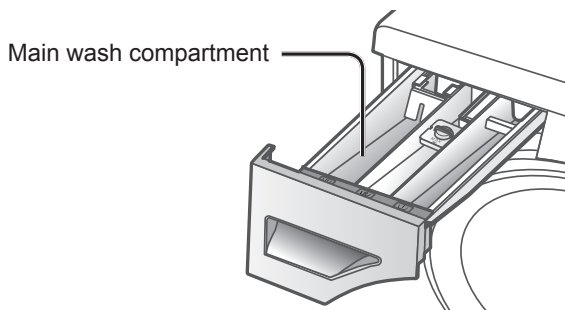

# Maintenance

## Cleaning your washing machine

- Clean the outside of your washing machine with a soft cloth and mild detergent such as kitchen detergent and soap water.

\* Don't splash water over the washing machine.

\* Do not use cream cleansers, thinners or products containing alcohol or kerosene.

## Cleaning your detergent drawer

First, remove the detergent drawer by lifting and pulling at the same time.

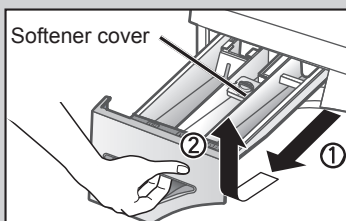

- Wash out old detergent from the drawer with water. (Use a cloth to clean the washing machine.)

\* Residue detergent soon builds up if you don't clean the drawer regularly, and can develop mould.

## Cleaning your washing machine door seal and window

(see also page 6)

- Wipe the window and seal after each wash to remove lint and stains. If lint builds up, it can cause leaks.
- The door opens at different angles if the drum seal is wet.
- Remove any coins, buttons and other objects from the door seal after each wash.

## Cleaning the filter net of the water supply valve

(applicable products only)

### ■ If water isn't draining properly

(Depressurize the water-supply hose.)

- 1 Turn the water supply off at the tap.
- 2 Switch the power on.
- 3 Close the washing machine door.
- 4 Select Tub Clean programme and press the START button.
- 5 After one minute, switch the power off.
- 6 Loosen the water supply valve and remove it from the tap.
- 7 Use a small brush, e.g. a toothbrush to clean the filter.
- 8 Re-connect the water supply valve to the tap and turn the tap back on, checking for leaks.

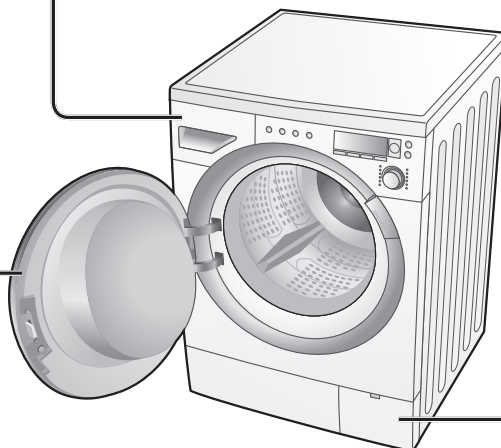
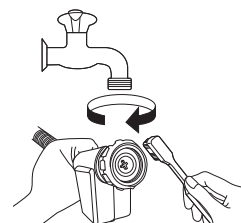

## Cleaning the drain filter



Take care not to burn yourself while handling your clothes or touching the inside of the drum after a high temperature wash.

Before cleaning the drain filter, switch off and unplug the washing machine.

- 1 Open and remove the drain filter cover.

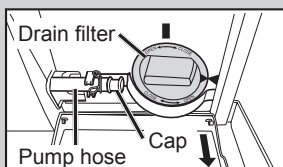

- 2 Take the pump hose out, remove the cap to drain the water, and put them back to the original position after all the water drains away. (Max 6L)

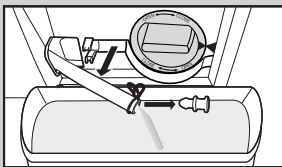

- 3 Carefully loosen the drain filter. More water may drain out - this is normal.
- 4 Turn it anticlockwise, unscrew the filter and remove it.

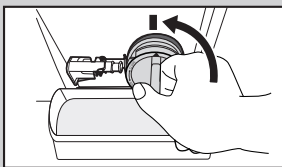

- 5 Remove any lint and debris before carefully replacing the filter.

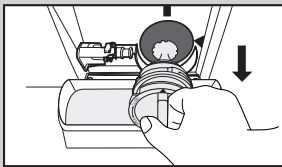

- 6 In order to return filter to where it was
  - 1) Set filter by joining mark ▲ of filter and mark ■ of washer body side.
  - 2) Turn right until reach to mark ▲ of washer body.

## Preventing a frozen water supply hose

\* If your washing machine is delivered in freezing weather conditions, leave it at room temperature for 24 hours after you've set it up before using it. This ensures there's no ice blocking the water supply hose.

### If your water supply hose freezes:

- 1 Wrap warm towels around the joints in the water supply hose.

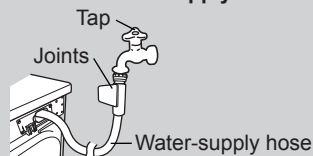

- 2 Add two or three litres of warm water to the drum.

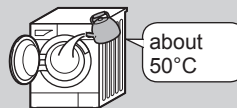

- 3 Run a Drain only programme, using the MODE button.

\* Make sure you replace the filter tightly. If it's still loose, you'll get an error message and may not be able to use the washing machine again until you tighten it securely. (see page 32)

# Troubleshooting

	Problem	Cause
<b>washing machine</b>	<b>Buttons don't work</b>	<ul style="list-style-type: none"> <li>• While the washing machine is washing, you cannot change the programme, temperature and process settings (but you can change the rinse or spin settings).</li> </ul>
	<b>Door doesn't open</b>	<ul style="list-style-type: none"> <li>• Door lock may be active. (see page 9)</li> <li>• Child safety lock may be active. (see page 26)</li> <li>• The water temperature or level could be too high.</li> <li>• Clothing may be caught in the door. If so, press the door opening button while pushing the door.</li> </ul>
	<b>Unusual odour</b>	<ul style="list-style-type: none"> <li>• Rubber parts may give off a smell when you first start using the washing machine, but this goes away over time.</li> <li>• You can wash the drum by running the Tub Clean programme (see page 22)</li> </ul>
<b>Wash</b>	<b>You can't see any water</b>	<ul style="list-style-type: none"> <li>• This is normal: the water level is below the window.</li> </ul>
	<b>There's no water going into the washing machine</b>	<ul style="list-style-type: none"> <li>• The water tap might be turned off.</li> <li>• The water hose or water-supply hose may be frozen.</li> <li>• Your water supply may be disrupted.</li> <li>• The water-supply valve filter, at the joint of the water-supply hose, may be clogged (see page 28)</li> </ul>
	<b>There's only a small amount of water</b>	<ul style="list-style-type: none"> <li>• If you have paused the programme and you restart, the washing machine may drain some water.</li> <li>• Don't pour water in through the door.</li> </ul>
	<b>Water adds up during washing</b>	<ul style="list-style-type: none"> <li>• This is normal: water is supplied automatically as the level lowers, and with heavy loads the water may fill up repeatedly.</li> </ul>
	<b>Water drains away during washing</b>	<ul style="list-style-type: none"> <li>• This is normal: water often drains and refills to wash off excess foam. (This is called foam detection.)</li> </ul>
<b>Rinse/Spin</b>	<b>There's no water going into the washing machine during rinse operation</b>	<ul style="list-style-type: none"> <li>• Before rinsing, the washing machine spins to drain water remaining from the wash. The water will fill up after that.</li> </ul>
	<b>Rinsing begins before the spinning finishes</b>	<ul style="list-style-type: none"> <li>• If your laundry has collected to one side of the drum, rinsing will start automatically to correct the imbalance.</li> <li>• If there's excess foam after washing, water may drain and refill to wash it off. (This is called foam detection.)</li> </ul>
	<b>During the spin-dry, the drum stops and rotates several times</b>	<ul style="list-style-type: none"> <li>• This is normal. The washing machine has detected an unbalanced load and is trying to correct it.</li> </ul>
	<b>A foam and water remain in a door or door seal</b>	<ul style="list-style-type: none"> <li>• Although a foam and water may remain with the state of clothing and the amount of detergent, it does not have influence on the performance of a rinse.</li> </ul>
	<b>Spin starting is repeated.</b>	<ul style="list-style-type: none"> <li>• This is normal. Although spin starting may be repeated, it is a function made to spin quietly.</li> </ul>
<b>Time</b>	<b>The displayed remaining time changes</b>	<ul style="list-style-type: none"> <li>• The remaining time is estimated and corrected continually, and this can change the time displayed. The displayed time is standard times, which may differ from the actual time required.</li> <li>• The remaining time will increase if an extra rinse and spin is required to correct the imbalance caused by laundry collecting to one side of the drum.</li> </ul>

	Problem	Cause
<b>Detergent and foam</b>	<b>There's not much foam</b>	<ul style="list-style-type: none"> <li>• This can happen if you've put powder detergent directly into the drum – you must put it in the detergent drawer.</li> <li>• The amount of foam can vary, depending on the temperature, level and softness of your water.</li> <li>• You may not be using enough detergent.</li> <li>• You may be using a reduced-foam type of detergent.</li> <li>• Heavily soiled laundry can reduce the amount of foam.</li> <li>• Larger loads of laundry can also reduce the amount of foam.</li> </ul>
	<b>There's a lot of foam</b>	<ul style="list-style-type: none"> <li>• The amount of foam can vary, depending on the temperature, level and softness of your water.</li> <li>• You may have used too much detergent.</li> <li>• The type of detergent you use could cause excess foam.</li> </ul>
	<b>There's no foam</b>	<ul style="list-style-type: none"> <li>• This can happen if you've put powder detergent directly into the drum – you must put it in the detergent drawer.</li> <li>• If your laundry has collected to one side of the drum, water will be supplied automatically to correct the imbalance – and this will prevent the foam wash.</li> <li>• The amount of foam can vary, depending on the temperature, level and softness of your water.</li> </ul>
	<b>Fabric softener overflows</b>	<ul style="list-style-type: none"> <li>• You may have exceeded the MAX level on the detergent drawer. (see page 11)</li> <li>• You may have spilt the liquid by closing the detergent drawer too sharply.</li> </ul>
	<b>There's a residue of powder detergent at the end of the wash</b>	<ul style="list-style-type: none"> <li>• This can happen if you've put powder detergent directly into the drum – you must put it in the detergent drawer.</li> </ul>
<b>Noise</b>	<b>There's an unusual noise or vibration</b>	<ul style="list-style-type: none"> <li>• Check there's nothing metal in the drum.</li> <li>• Make sure the anchor bolts used in transportation have been removed.</li> <li>• Check the washing machine is on a flat, stable surface.</li> <li>• If none of the above seem to be causing the problem, contact your nearest Customer Service Centre.</li> </ul>
	<b>There's a noise when the water drains away</b>	<ul style="list-style-type: none"> <li>• This is normal: it's the pump starting and stopping.</li> </ul>
	<b>There's a fan noise</b>	<ul style="list-style-type: none"> <li>• This is normal: it's the fan cooling electric parts.</li> </ul>
<b>Others</b>	<b>The electricity supply cuts out while the washing machine's on</b>	<ul style="list-style-type: none"> <li>• The washing machine will stop, and won't start by itself when the power comes back on. You'll need to select a programme and start it again.</li> </ul>
	<b>A circuit breaker trips the electricity supply</b>	<ul style="list-style-type: none"> <li>• The washing machine will stop, and won't start by itself when you reset the breaker.</li> <li>• You'll need to find out what caused the breaker to trip, and put this right. Then reset the breaker, turn your electricity supply back on, and start the washing machine again.</li> </ul>
	<b>The water supply is disrupted</b>	<ul style="list-style-type: none"> <li>• When the water comes back on, it may be impure at first. You'll need to disconnect the water-supply hose and drain any impure water through the tap before using your washing machine again. Remember to re-connect the water-supply hose first.</li> </ul>
	<b>The display isn't clear</b>	<ul style="list-style-type: none"> <li>• This is probably because your washing machine is in a brightly lit or sunny position.</li> </ul>

# Error display

(When the error display comes on, a buzzer sounds and U and a number appear alternatively.)

<p style="text-align: center;">U 11</p> <p style="text-align: center;">Unable to drain</p>	<p><b>What to do:</b></p> <p>Check the drain hose, making sure</p> <ul style="list-style-type: none"> <li>• it isn't clogged up</li> <li>• its tip isn't immersed in water</li> <li>• it doesn't extend further than 3 metres</li> <li>• the water isn't frozen.</li> <li>• Cleaning the drain filter (see page 29)</li> </ul> <p>Correct any of these problems, then open the door, shut it and start the washing machine again.</p>
<p style="text-align: center;">U 12</p> <p style="text-align: center;">Door is open</p>	<p><b>What to do:</b></p> <ul style="list-style-type: none"> <li>• Make sure the door is shut properly.</li> </ul>
<p style="text-align: center;">U 13</p> <p style="text-align: center;">Unable to spin-dry</p>	<p><b>What to do:</b></p> <ul style="list-style-type: none"> <li>• The laundry may be too heavy. If so, unravel a tangle of items.</li> <li>• The laundry may be too light. If so, add one or two bath towels.</li> <li>• One or more items may be too large, such as blankets. If so, reduce the load.</li> <li>• The washing machine may be on an unstable or uneven surface.</li> </ul> <p>Correct any of these problems, then open the door, shut it and start the washing machine again.</p>
<p style="text-align: center;">U 14</p> <p style="text-align: center;">Unable to supply water</p>	<p><b>What to do:</b></p> <ul style="list-style-type: none"> <li>• Check the tap is open.</li> <li>• Check the water pipe or hose isn't frozen.</li> <li>• Check the water supply hasn't been disrupted.</li> <li>• Check the water-supply valve filter isn't clogged. (see page 28)</li> </ul> <p>Correct any of these problems, then open the door, shut it and start the washing machine again.</p>
<p style="text-align: center;">U 18</p> <p style="text-align: center;">Drain filter is not set</p>	<p><b>What to do:</b></p> <ul style="list-style-type: none"> <li>• Make sure the drain filter is set properly. (see page 29)</li> </ul>
<p style="text-align: center;">H 01</p>	<ul style="list-style-type: none"> <li>• An error display starting with H doesn't sound the buzzer. Press the power OFF button. If the display stays on, or it reappears when you press the START button, unplug the washing machine and contact your nearest Customer Service Centre.</li> </ul>



# Choosing the right location

Entrust the installation of the product to our dealer or service agent.

## ■ The right place for your washing machine

- Make sure there's enough space for your washing machine – see the dimensions on the back cover.
- Install your washing machine on a flat, stable surface, to avoid excessive vibration and noise.
- If your floor isn't flat and stable, contact your Customer Service Centre.
- Don't install your washing machine in direct sunlight or in a place where temperatures reach freezing.

✗ Sloping surface



✗ Unstable surface

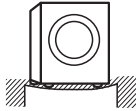

✗ Bumpy surface



Other things to avoid:

- That the openings of base must not be obstructed by a carpet.
- Don't let metallic part of the washing machine touch other metal surfaces of, sinks or other appliances.

## ■ Installing a built-in washing machine

- You need a space at least 60cm wide and extra 3mm space from the top and back of the washing machine.
- The counter above the washing machine must be firmly fixed to the adjoining cupboards.
- Be sure to connect the mains plug to an independent household dedicated mains socket, and also to the easily disconnectable position.
- Ask a sales dealer or service agent to install a metal cover on the washing machine (sold separately), instead of the standard cover panel, if the height of a space is 821-845mm.

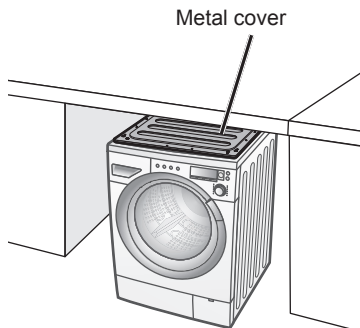

## ■ Separately sold accessories

If you need any accessories (such as the metal cover for built-in washing machine) contact your local Customer Service Centre.

- Metal cover (AXW4595-7FH0)

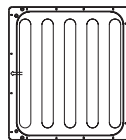

# Moving and installing

## ■ Removing the anchor bolts

Four anchor bolts keep the interior of the washing machine in place while it's being moved. They need to be removed before installation, using the spanner supplied and following the instructions below.

**Don't run the washing machine without removing the bolts, as this can cause excessive vibration.**

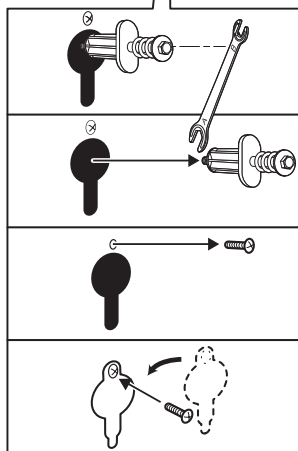
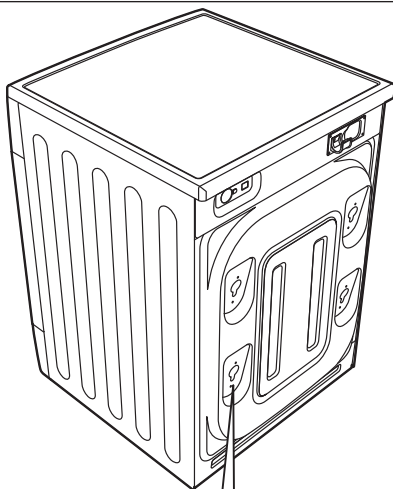

● To remove the anchor bolts:

- ① Use the 'B' end of the spanner to loosen the four bolts.
- ② Pull the bolts out horizontally.
- ③ Remove the screws which are alongside the bolt holes.
- ④ Push the four cover caps (included with your accessories) onto the respective bolt holes, and secure them with the screws you removed in step ③.

**You'll need the anchor bolts again if you move the washing machine, so make sure you keep them safe. And if the washing machine passes to someone else, make sure you give them the anchor bolts.**

# Moving and installing (continued)

## ■ Moving the washing machine from one location to another

**Make sure to fix the anchor bolts for transportation to the washing machine.**

### Before you move the washing machine

- Shut the tap and run the washing machine to drain the water. Drain any remaining water from the pump hose. (see page 29)
- Depressurise the water-supply hose and remove it.
- Disconnect the power cable.
- Attach the anchor bolts (see below).

## ■ Attaching the anchor bolts

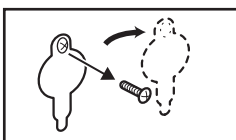

- ① Unscrew and remove the four cover caps.

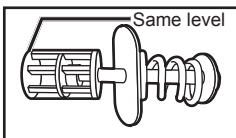

- ② Pull the bolts out, so their tips are level with the tips of the sleeves.  
(Ask someone else to hold the upper surface of the drum and pull it forward.)

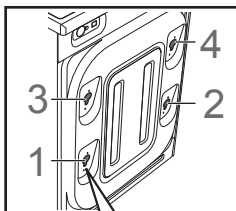

- ③ Insert the transportation guards 1, 2, 3 and 4.

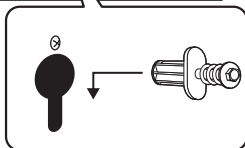

- ④ Tighten each bolt.

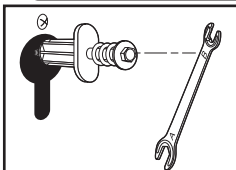

- ⑤ Tighten the bolt so that spring length becomes 26mm.

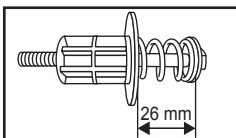

# Hose and cable lengths

How to connect for the left side

How to connect for the right side

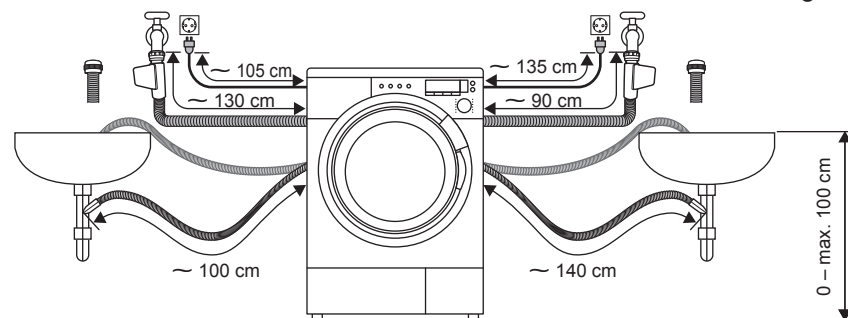

## Levelling the washing machine

- Using a level facilitates the adjustment.
- When adjusting the washing machine to make it level, ensure all four stands are supporting it:

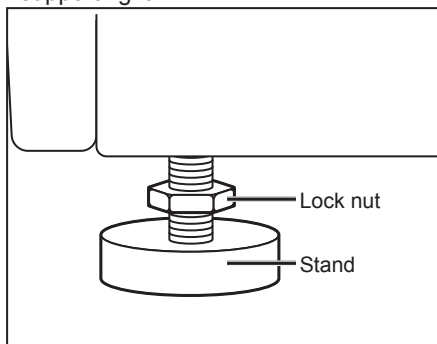

- 1** On each stand, loosen the lock nut by turning it clockwise using the A end of the spanner supplied.
- 2** Adjust all four stands in this way.
- 3** Use a spirit level to ensure the washing machine is standing correctly.
- 4** Tighten each lock nut by turning it anti-clockwise (towards the washing machine body), again using the A end of the spanner supplied.

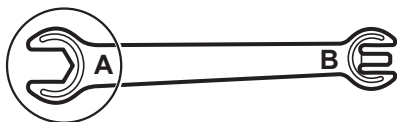

Ensure all four lock nuts are tightened securely. Check the stands are still bolted to the washing machine – if they're unbolted, the washing machine will move around.

- To adjust the stands, use A side of the included spanner.

# Water-supply hose



- Avoid the risk of electric shock. Do not put the security device for the water-supply valve in water, as it contains an electric valve.
- Follow the instructions in this section to avoid water leaks.
- Do not connect the hose to the combination tap.
- If you're unsure, ask a service agent to connect the hose.

## Points to remember:

- Don't twist, squash, modify or cut the hose.
- Optimum water pressure in the main pipe is **0.03 MPa - 1.0 MPa**.
- If your pressure is set higher than this, you'll need to install a depressurising valve.
- Water-flow from the tap should be more than 5 litres per minute.

## ■ Connecting the water-supply hose

- 1** Attach the hose to a tap, and tighten the plastic joint by hand.
- 2** Open the tap slowly and check there are no leaks around the joint.

Caution: the joint is subject to water pressure.

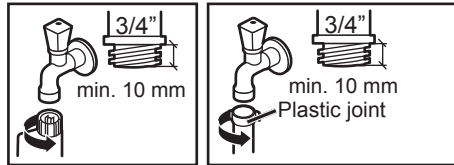

Hose with water-supply valve

Standard hose

## ■ Leak-proof System

This system is designed to prevent water leaks from the washing machine, and includes the following components:

### 1) Leak sensor

Located on the base plate of the washing machine, this sensor detects leaks and stops the washing machine. If this happens, an error display starting with H (e.g. H 01) will appear, and you should contact your Customer Service Centre.

### 2) Hose with water-supply valve (certain types of washing machine only)

If this type of hose becomes damaged and leaks, the valve closes automatically and stops the water supply.

### 3) Overflow detection

If water collects in the washing machine above a certain level, this function prevents the washing machine overflowing by stopping the water supply and activating the drain pump.

# Water-drain hose

## Points to remember:

Do not twist, pull out or bend the drain hose.

Your washing machine should be no more than 100cm from the drain outlet.

## Draining to a sink or wash-basin:



- Secure the drain hose in position, so it can't drop out of the basin.
- Don't block the basin's drain outlet, and make sure the drainage through it is sufficient.
- Don't let the tip of the drain hose dip into the drained water, as this can cause the water to flow back into the washing machine.

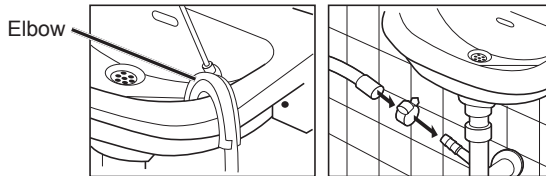

Draining to a wash-basin    Draining to a drain hose

# Connecting to the power supply



The name plate tells you the rated power your washing machine needs. Check that your power supply specifications match these.

## For your safety:

■ **Never plug your washing machine into an extension lead or power strip with multiple sockets.**

- If the mains lead or mains plug are damaged, stop using them and ask a service agent to replace them.

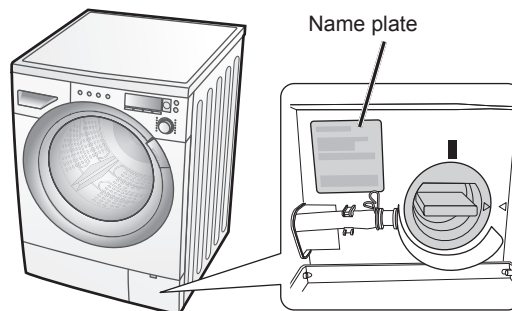



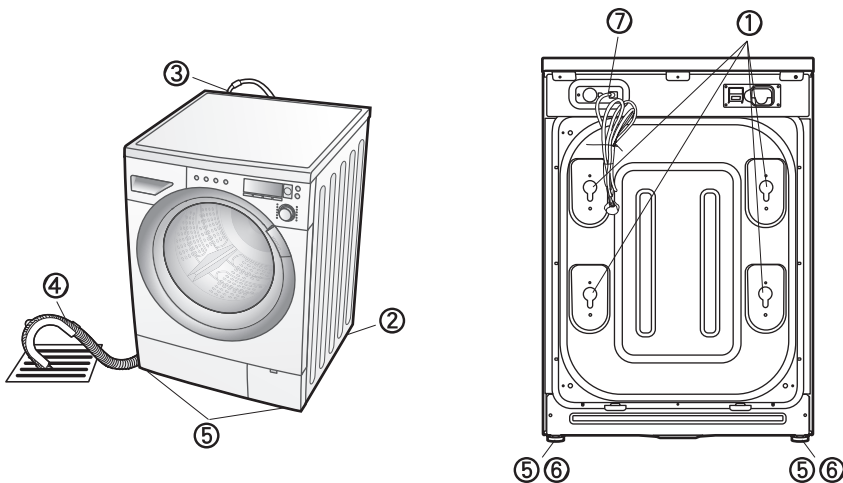

# Installation checklist

- ① Anchor bolts – have you removed them, and attached the cover caps properly?
- ② Location – is your washing machine on a flat, stable surface? Does it run without vibrating?
- ③ Water-supply hose – is it free from leaks, and is the water supply normal?
- ④ Water-drain hose – is it free from leaks, and does it drain normally?
- ⑤ Four adjustable stands – are they bolted securely to the washing machine?
- ⑥ Four stand cushions – are they standing flat?
- ⑦ Power supply – is the household dedicated mains socket, fully rated at AC 220V to 240V independently?



## Checking your washing machine runs properly

When your washing machine is running, follow the instructions below to check there are no water leaks, abnormal noise or vibration, and that the waste water drains properly.

Leak check		
① Press Power on.  On	② Press Pause/Start.  Start/Pause	③ Press Power off.  Off
Vibration and noise check		
① Press Power on.  On	② Select "Spin only" for process selection.	③ Press Pause/Start.  Start/Pause

# Specifications

	NA-16VX1	NA-16VG1	NA-14VA1
<b>Rated voltage</b>	220 - 240 V		
<b>Rated frequency</b>	50 Hz		
<b>Maximum energy rated power input</b>	2075 W - 2250 W		
<b>Heating energy rated power input</b>	2000 W (230 V)		
<b>Dimension of the product</b>	596 mm (W) x 625 mm (D) x 845 mm (H)		
<b>Weight of the product</b>	85 kg		
<b>Maximum mass of dry cloth</b>	7 kg		
<b>Water consumption</b>	Refer to "Power and water consumption".		
<b>Pressure of tap water</b>	0.03 MPa - 1 MPa		

## ■ Washing machine dimensions in millimetres

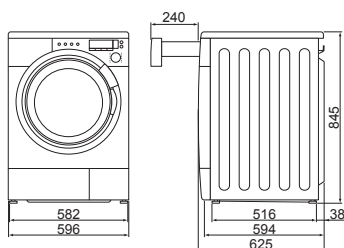

### Note

It's normal for a new washing machine to contain a small amount of water, remaining after factory inspection.

## ■ Carrying the washing machine

**Two or more people must carry the washing machine.**

Start by tilting the washing machine backwards.

One person should stand behind it, holding the rear of the top panel. The other person should grip the bottom stands at the front.

- Don't touch the door opening button while holding.
- Make sure of the needed accessories for installation. (see page 6)
- Entrust the installation of the product to our dealer or service agent.



Panasonic Corporation  
Web Site : <http://panasonic.net>

Pursuant to the directive 2004/108/EC, article 9(2)  
Panasonic Testing Centre  
Panasonic Marketing Europe GmbH  
Winsbergring 15, 22525 Hamburg, Germany

© Panasonic Corporation 2009



0 0 0 1 0 2

Printed in china  
February 2009  
W9901-7GX10