

# **VESTEL**

## **WASHING MACHINE**

### USER MANUAL

**WASH & DRY**

**CKA-XXL 9614 TE - CKA- XXL 9614 TKE - CKA-XXL 9614 TXE -  
CKA-XXL 9614 TGE**



**VESTEL**

# CONTENTS

<b>BEFORE USING YOUR MACHINE</b>	<b>5</b>
• Correct use	5
• General warnings	6
• Safety warnings	9
- Burn risk	9
- Electrocution risk	10
- Flooding risk	10
- Explosion risk	12
- Fire risk	12
- Fall and injury risk	14
- Child safety	15
<b>THE ENVIRONMENT</b>	<b>16</b>
• Disposing of packaging and your old machine responsibly	16
<b>SAVINGS &amp; EFFICIENCY INFORMATION</b>	<b>17</b>
<b>OVERVIEW OF YOUR DEVICE</b>	<b>18</b>
• General Appearance	18
• Technical specifications	20
<b>SETTING UP THE MACHINE</b>	<b>21</b>
• Removing the transportation safety screws	21
• Placing the machine and adjusting the adjustable foot	23
• Electrical connection	25
• Water inlet connection	26
• Water draining connection	27
<b>CONTROL PANEL</b>	<b>28</b>
• Detergent drawer general view	29

• Detergent drawer compartments	30
• Programme button	31
<b>ADJUSTING MACHINE SETTINGS</b>	<b>32</b>
• Language selection setting	32
• Eco time settings	36
• Current time setting	38
• Sound adjustment	40
• Screen brightness setting	41
• Screen contrast setting	41
• Revert to factory settings	42
<b>WASHING OPERATION</b>	<b>43</b>
• Sorting laundry	43
• Explanation of washing machine symbols	44
• Placing laundry into the machine	45
• Adding detergent and other chemicals	48
• Program selection	50
• If you want your laundry dried at the end of washing	51
• Cupboard dry	51
• Hanger dry	52
• Iron dry	53
• Drying with duration	54
• Additional functions	55
• Pre-wash additional function	56
• Extra rinse function	57
• Anti-allergic additional function	58
• Easy ironing additional function	59
• Economic time interval additional function	60
• Delay Time / Finish time adjustment additional function	63
• Memory record function button (memory)	65

• Start/Pause button	71
- Starting the a programme	71
- Pausing a programme / adding laundry	74
- Cancelling a programme	74
- Finishing programme	75
- Child lock	76
• Programme table	78
- Cotton	78
- Cotton Eco	78
- Eco 20°	79
- Synthetics	80
- Delicates	81
- Wools / Silk	81
- Duvet	82
- Extras	83
- Cotton dry	83
- Gentle dry	83
- Rinse / Spin	84
- Drain / Drum clean	85
- Super rapid 12 min	86
- Daily Fast 60° 60 min	86
- Refresh	87
- Wash & Dry 29 min	88
- Synthetics Wash & Dry	88
- Cotton 60° Wash & Dry	89
- Cotton 90° Wash & Dry	89
• Selecting sub-programmes (Synthetics)	90
• Selecting sub-programmes (Delicates)	92
• Selecting sub-programmes (Extras)	94
<b>MAINTENANCE AND CLEANING OF YOUR MACHINE</b>	<b>97</b>

• Water inlet filters	98
• Detergent drawer maintenance and cleaning	99
• Liquid detergent apparatus	99
• Siphon cover	100
• Drum cleaning	100
• Body cleaning	100
• Pump filter maintenance and cleaning	101
<b>TROUBLESHOOTING</b>	<b>103</b>
<b>AUTOMATIC FAULT WARNINGS AND WHAT NEEDS TO BE DONE</b>	<b>108</b>
<b>INDEX</b>	<b>113</b>

# BEFORE USING YOUR MACHINE

## Correct Use

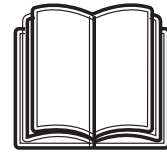

- **Read this user's manual.**
- **Your machine is designed to be used in domestic environments. Using it for commercial purposes shall cause your warranty to be void.**
- Do not let your pets near the machine.
- Please check the packaging of your machine before installation, and the outer surface of the machine after the packaging has been removed. Do not operate damaged machines or machines with opened packaging.
- Have your machine installed only by an authorised service company. Any interference to your machine by anyone other than authorized services shall cause your warranty to be void.
- This appliance is not intended for use by people (including children) with reduced physical, sensory or mental capabilities, or lack of experience or knowledge, unless they have been given supervision or instruction concerning use of the appliance by a person responsible for their safety.
- Please use your machine for laundry that is specified as washable and dryable after washing by their manufacturer on their label.

- **You must remove the transportation safety screws before your machine's first use. The machine will malfunction if it is operated with the transport safety screws still in place and this will void your warranty.**

- Your machine warranty does not cover damage caused by external factors (floods, fire, rodents etc.)
- Please do not throw away this user manual. Store it in a safe place. It might be needed by you or the next user.

## **General warnings**

- The necessary ambient temperature for your machine's ideal operation is 15-25°.
- Frozen hoses can tear and explode. In regions where the temperature is below zero, the electronic card may not operate safely.
- Please ensure that the clothes you will load into your machine do not have foreign substances (nails, needles, coins, lighters, matches, clips etc.) in their pockets. These foreign substances can damage your machine.
- Before starting to use your machine, you may call the nearest authorized service company and request help for installation, operation and use of your machine.

- **It is advised that the first washing operation is conducted by putting 1/2 scale detergent in compartment number 2 of the detergent drawer and run the machine without any clothes in on the “DRUM CLEANING” program. (Please see program table page 85)**
- As detergent or softener exposed to air for a long time may cause residues, only put your detergent or softener in the detergent drawer at the beginning of each wash.
- It is advised that you unplug your machine and close the water inlet tap if you will not use your machine for a long time. You should also leave the door of your machine open to prevent bad odours forming due to humidity.
- Some water might be left in your machine due to trials and tests conducted for Quality Control procedures during production. This causes no harm to your machine.
- Keep the document bag that came inside your machine that contains the user manual out of the reach of children and babies to prevent the risk of suffocation.
- Keep small parts found in the document part away from the reach of children and babies.
- Use pre-wash programs only for very dirty laundry.



- You should not load your machine with the amount of laundry that will exceed the maximum laundry amount specified in the washing or drying program you have chosen.
- In case of any malfunction, unplug the machine and close the tap first. Do not attempt to repair by yourself and consult the nearest authorized service company.
- Never open the detergent compartment when the appliance is running.
- Never force the door open when the machine is running.
- Please adhere to the manufacturers' advice regarding the use of fabric conditioner or similar products you will use in your machine.
- While your machine is in the drying process, please do not stop your machine before the program ends.

If you have to do this, remove all your laundry fast and spread them on an appropriate place immediately to allow them to cool down.

- Set up your machine in a place where its door can be completely opened. (Do not set up your machine in places where its door cannot be fully opened.)
- Set up your machine in locations that can be ventilated and might have constant air circulation.



## **Safety warnings**

**You must read these warnings. Ignoring these warnings may put you or your loved ones at risk of fatal injuries.**



### **Burn risk!**

- Do not touch the discharge hose or the water discharged during the discharging process as the appliance may reach high temperatures when running.
- Open the door of the machine all the way after the drying process. Do not touch the door glass. Burn hazard may occur due to high temperature.



## Electrocution risk!

- Do not use multiple plugs or extension cords.

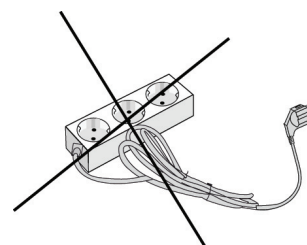

- Do not plug in damaged plugs or plugs with torn cables.
- Never pull from the cable when unplugging.
- Grab the plug when unplugging.
- Do not plug-in or out the plug from the receptacle with wet hands to prevent electric shock.
- Never touch the machine with a wet or damp hand or foot.
- Call the nearest authorized service company for assistance if the power cord malfunctions.



## **Flooding risk!**

- Check whether the water flows fast or not before hanging the discharge hose on the sink.
- Take necessary measures to prevent the hose you hung from slipping.
- The backfiring force of a hose that is not placed appropriately can move the hose from the place it is hung on the sink. Take measures to prevent the plug in your sink from plugging the sink hole.



## **Explosion risk!**

- As there is a drying function on your machine, make sure that materials like stain removing chemicals or washing gas that you might have applied on your laundry earlier are properly rinsed and purged. There might be a risk of explosion when you run your machine with the drying function otherwise.



## **Fire risk!**

- Unwashed dry laundry must not be dried in your machine.
- Do not keep flammable or explosive liquids near your machine.
- Materials stained with food oil, acetone, alcohol, petrol, kerosene, stain remover, turpentine, beeswax and beeswax remover must first be washed with an extra amount of detergent and hot water before being put through the drying process. There might be a risk of fire when you run your machine with the drying function otherwise.
- If you're going to choose a washing and drying program, do not place a detergent dose adjustment device/ball into your machine. They might pose a fire risk.

- Laundry **must not be dried in the machine** under the conditions specified below due to the risk of fire:
  - If laundry is not washed.
  - If oil stains and other stains on the laundry (food oils, balms and cosmetic remains, kitchen swab etc.) are not cleaned enough.
  - Laundry cleaned with industrial chemicals.
  - Laundry that has high amount of foam-sponge-rubber or rubber-like parts and accessories on.
  - Rubber, sponge(latex), shower bonnet, watertight textile products, rubber based objects and clothes or pillows filled with rubber sponge must not be dried in the washing machine with the drying function.
  - Stuffed and damaged parts (pillows or jackets).  
The sponge parts dangling outside these stuffings might catch fire during the drying process.
  - The sulphur in paint-removing materials might cause corrosion. Thus, never use paint-removing materials in your machine.
  - Please ensure that detergent cups are not left inside the laundry. These plastic cups might melt during drying and damage your machine and laundry.
  - Laundry that has had a stain removal process applied must be rinsed thoroughly before washing.

- Never use products that contain solvent material (like washing gas) in your machine.
- Remove all the objects in the pockets of your laundry (needles, paperclips, lighters, matches etc.) when loading your machine. **Fire and Explosion risk may occur.**



## **Fall and injury risk!**

- Do not climb on your machine. The upper table of your machine may break and you might get injured.
- Tidy the hose, cable and packaging of your machine during installation. You might trip over and fall.
- Do not turn your machine upside down, or on its side.
- Do not lift your machine by holding it from extruding parts (detergent drawer, door). These parts might break and cause you injury.
- There's a risk of tripping and injury if the materials like hoses and cables are not properly stored after your machine is installed.

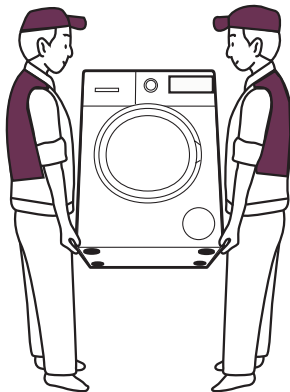

Machine must be carried by 2 people or more.



## Child safety!

- Do not allow your children to play with the machine. It is an electrically driven appliance.
- Do not leave children unattended near the machine. Children might lock themselves into the machine.
- The door glass and machine surface might be extremely hot during your machine's operation.
- It is therefore especially important that children do not touch the machine as it may damage their skin.
- Keep packaging material away from children.
- Poisoning might occur if the detergent and other washing aids are consumed, and eye or skin irritation might occur if they come into contact with the skin. Keep the cleaning materials where children cannot reach them.

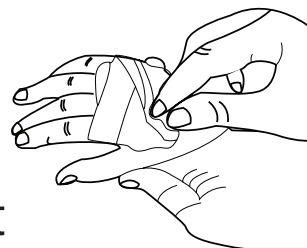



# PACKAGING AND THE ENVIRONMENT

## DISPOSING OF PACKAGING AND YOUR OLD MACHINE RESPONSIBLY

### Removal of packaging materials

Packaging materials protect your machine from the damage that might occur during transportation. Please recycle your packaging materials.

Recycled material provides both raw material savings and decreases waste production

### Removal of old machine

Old electrical devices might still contain salvageable parts. So, never throw your old devices that you do not use into the waste.



Ensure the parts of your old electronic or electrical devices are reused by giving them to your local recycling centre.

**Please ensure your old appliances are kept in an appropriate place for the safety of children until they are taken outside the house.**

# SAVINGS & EFFICIENCY INFORMATION

Some important information to get more efficiency out of your machine:

- The amount of laundry you put in your washing machine should not exceed the maximum amount indicated. By avoiding overloading, your machine shall run more efficiently.
- Not using pre-wash feature for normal and lightly soiled laundry shall save electricity and water.

# OVERVIEW OF YOUR DEVICE

## General Appearance

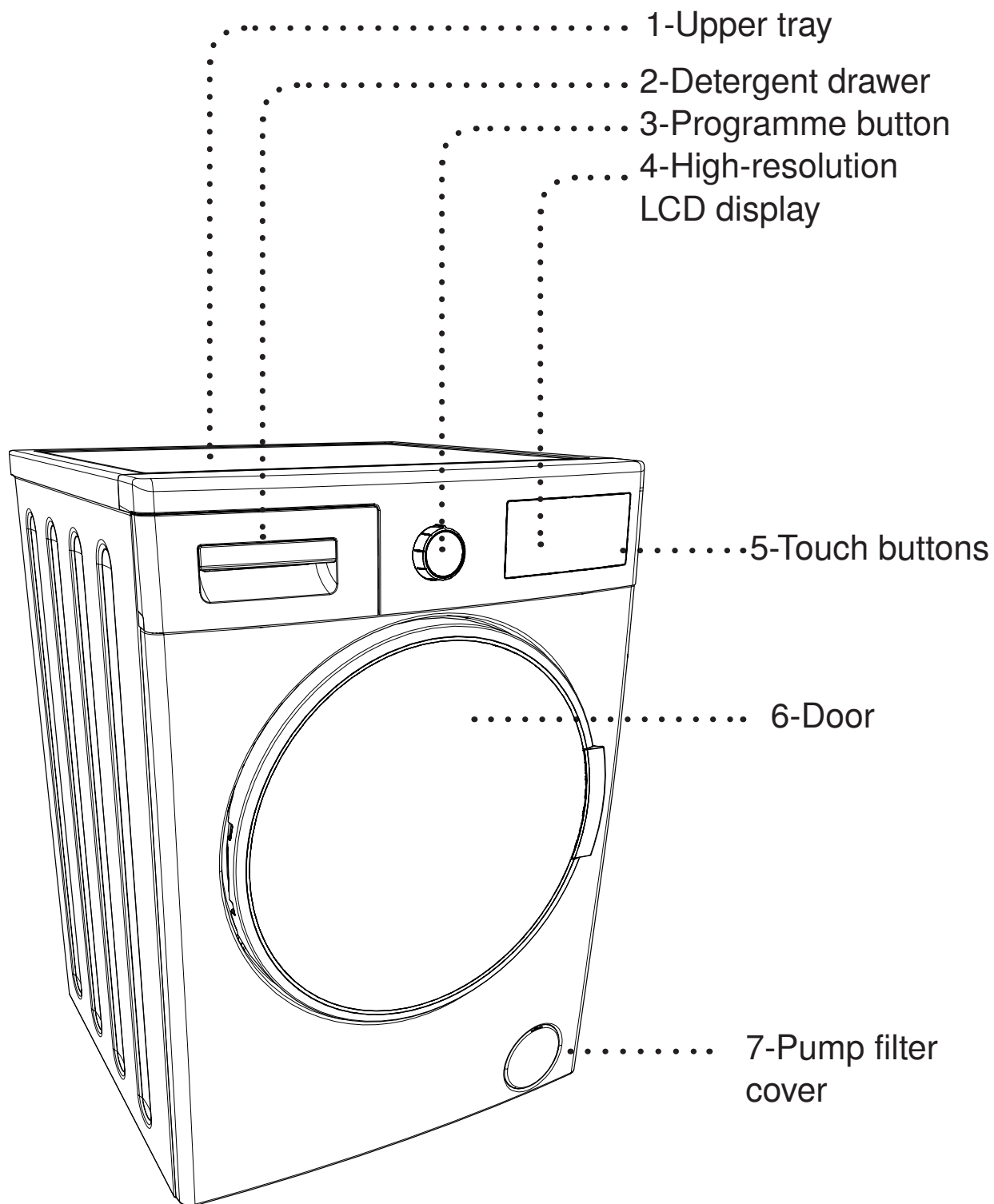

## General Appearance

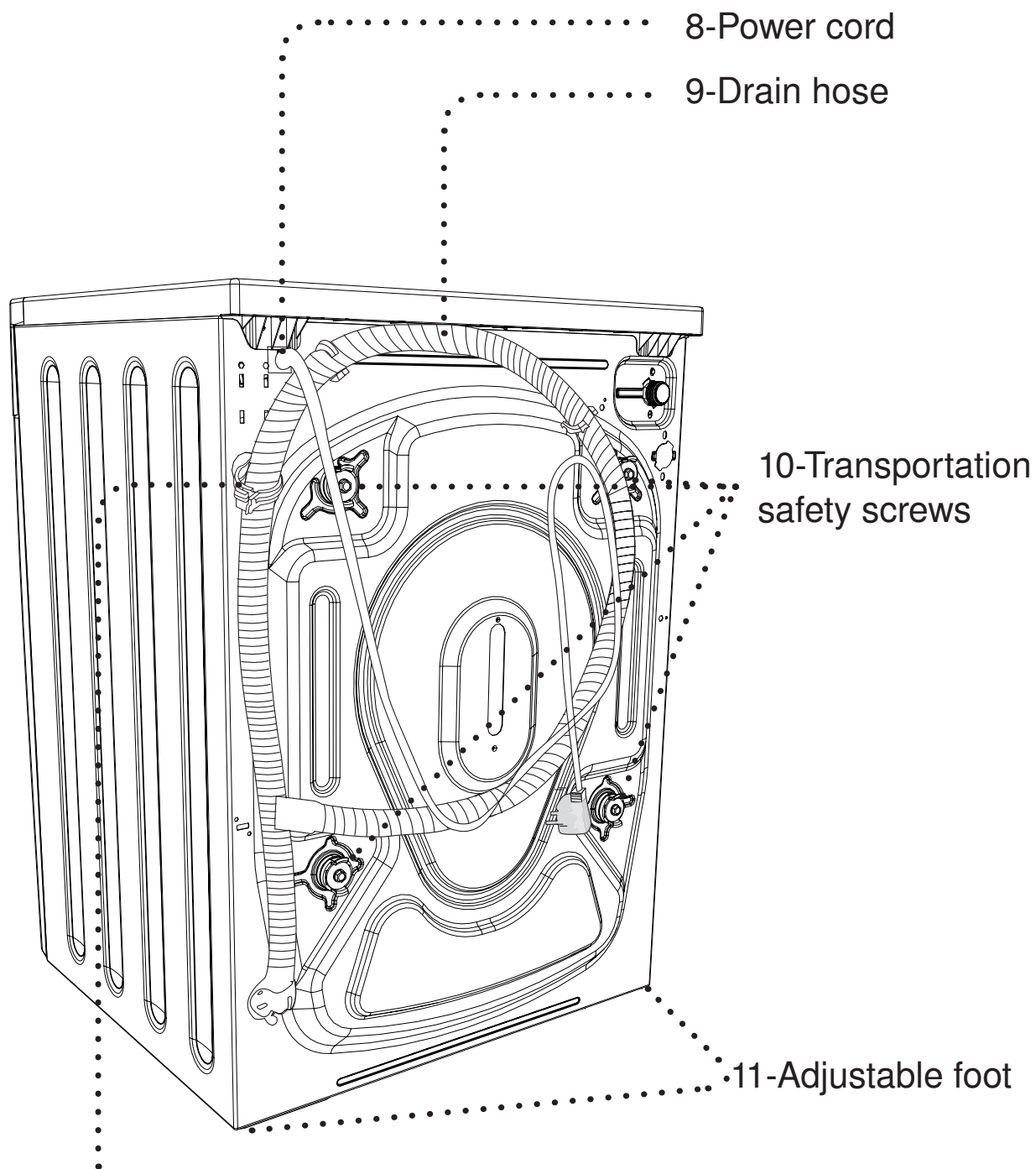

12-Drain hose holding plastic:  
(The operation of the machine will be affected if this plastic part is removed. So please don't remove this plastic part under any condition.)

# Technical Specifications

Maximum washing capacity (dry laundry) (kg)	9.0
* Maximum drying capacity (kg)	6.0
Spin speed (rev / min)	1400
Number of programs	15
Operating voltage / frequency (V/Hz)	220-240 / 50
Water pressure (Mpa)	Maximum:1 Minimum:0.1
Dimensions (hxwxl) (mm)	845x597x582
* Unwashed dry laundry must not be dried in your machine.	

Energy consumption (washing, spinning, drying) (kWh/cycle)	6,12
Energy consumption (washing and spinning only) (kWh/cycle)	0,90
Water consumption (washing, spinning, drying) (L/cycle)	112
Water consumption (washing and spinning only) (L/cycle)	48

Control programs in accordance with <b>EN 50229</b> standart
<b>Program will be used for Washing cycle :</b>
<i>Program: Cotton Eco, Load: 9 kg, Temperature: 60°C, Spin Speed: Max – 1400 rpm, Option: No option will be selected.</i>
<b>Programs will be used for Drying cycle:</b>
<b>Drying of 1st part:</b>
Program : 7th Program Extras sub-program “cotton dry”, Load: ~4.5 kg (1 sheet +16 pillowcases) Option: Dry: hanger (👉)
<b>Drying of 2nd part:</b>
Program : 7th Program Extras sub-program “cotton dry”, Load: ~4.5 kg (2 sheets + 2 pillowcases + all towels) Option: Dry: hanger (👉)

# SETTING UP THE MACHINE

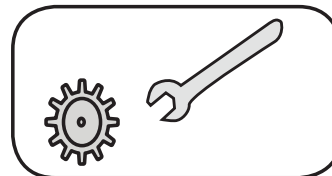

Have your machine installed only by an authorized service company.

## Removing transportation safety screws

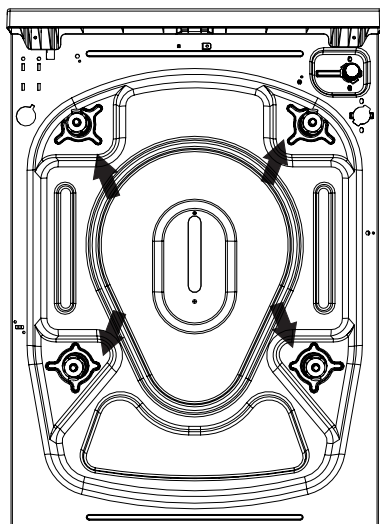

Before operating your machine, you must remove the transport safety screws on the backside of the machine.

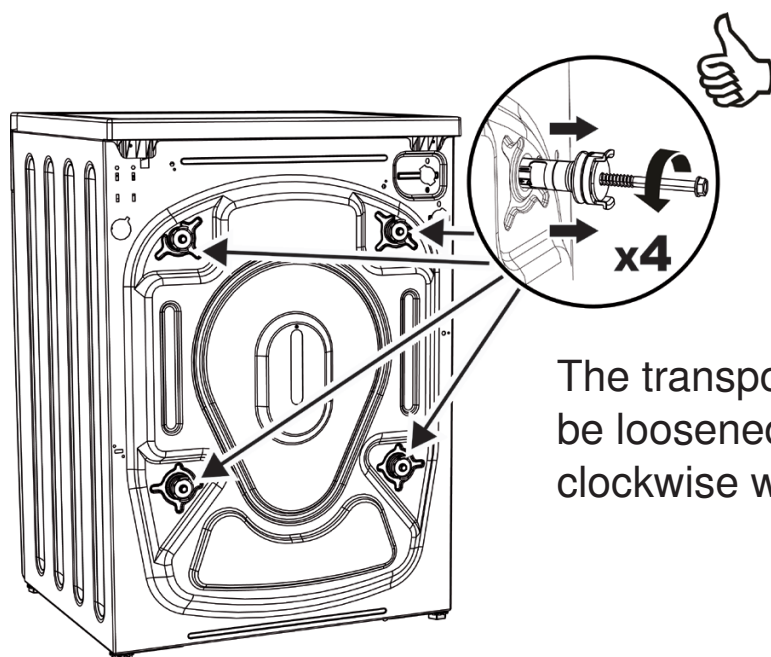

The transport safety screws should be loosened by rotating them counter clockwise with an appropriate wrench.

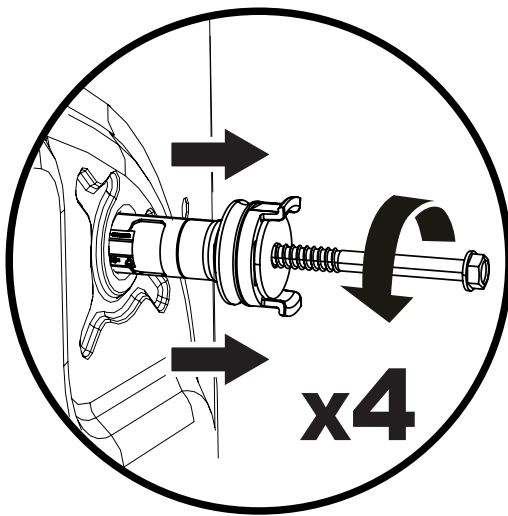

Transport screws should then be removed by pulling them out. The removed transport safety screws should be stored to be used again in case the machine needs to be transported again, e.g. if moving house.

**NOTE:** You must remove the transportation screws from your machine before first use. Faults occurring in machines operated with transport screws still fitted shall be out of the scope of the warranty.

Place the plastic transportation screw caps found in the accessory bag in the gaps left by the transportation screws.

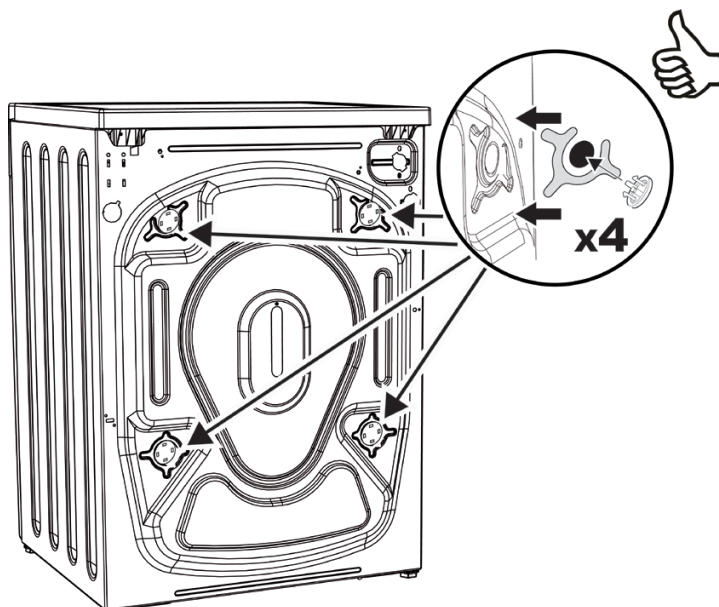

## Placing the machine and adjusting the adjustable foot

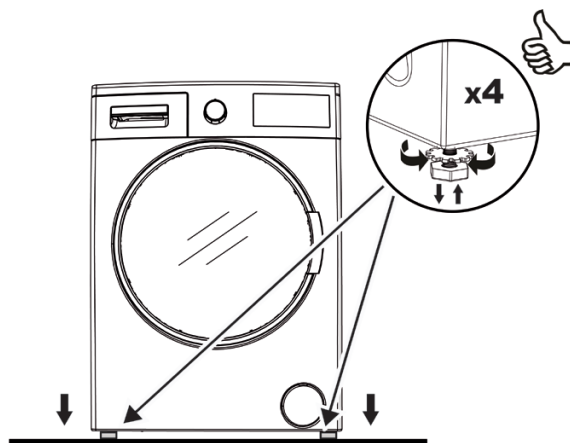

Do not install your machine on a carpet or such ground that will block ventilation from the base.

To ensure silent and vibration-free operation of your machine, it should be deployed on a non-sliding and firm ground.

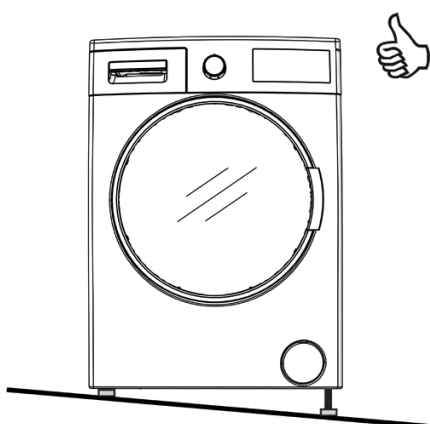

You can adjust the balance of your machine by a gauge from the top.

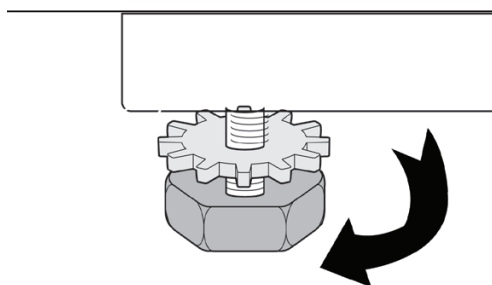

You can adjust the balance of your machine by the adjustable foot.

- Loosen the plastic adjustment nut.
- Adjust the feet upward and downward by rotating them.



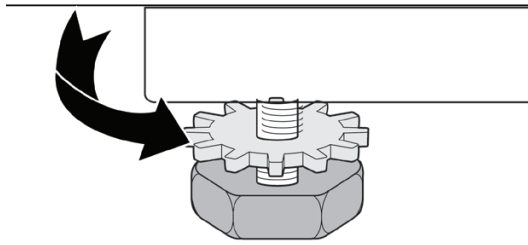

- Tighten the plastic adjustment nut after balance is achieved.



- Never put cardboard, wood or suchlike materials under your machine if you are intending to stabilize the distortions on the ground.
- When cleaning the ground, on which your machine rests, be careful not to disrupt the machine's stability.



## Electrical connection

- Your washer-dryer is adjusted for 220-240V and 50Hz.
- The mains cord of your machine is equipped with a specific grounded plug.
- The mains plug should always be inserted to a grounded receptacle of 10 amperes. The fuse current value of the power line connected to this plug should also be 10 amperes.
- If you don't have such a receptacle and fuse conforming with this, please have it done by a qualified electrician.
- We do not take responsibility for damages that occur due to ungrounded usage.

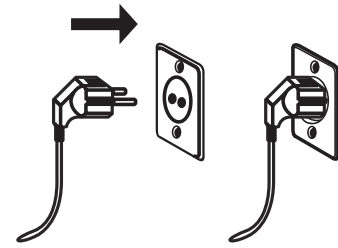

**Note:** Operating your machine under low voltage will cause the life cycle of your machine to be reduced and its performance to be restricted.

## Water inlet connection

- Operate your machine with cold water only.
- Use only the new water inlet hoses given with your machine or purchased through authorized dealers.

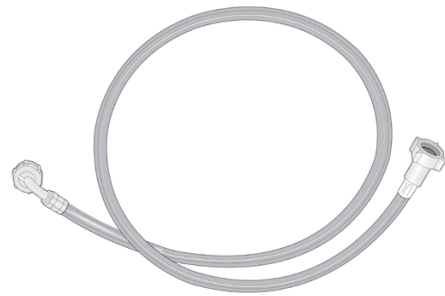

- 1 gasket is included in the hose packaging to prevent water leaks in connections. Fit this gasket to the end of new water inlet hose on the side of faucet.

- Connect the white end of the water inlet hose to the water entrance valve on the back of the machine. Tighten plastic parts on the hose using your hand.

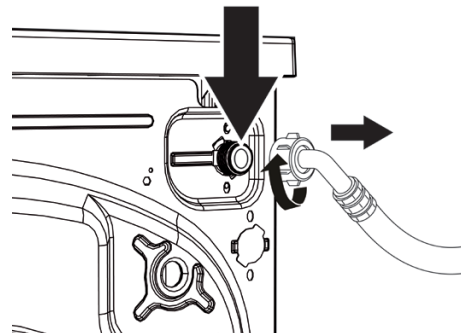

- Connect the other end of the water inlet hose to a 3/4" water tap with threads. Tighten plastic parts on the hose using your hand.

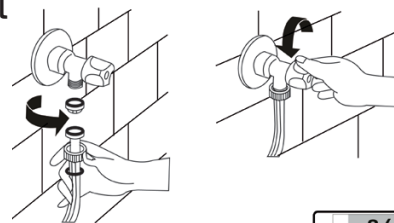

- In uncertain conditions, have the connection works done by a qualified plumber.

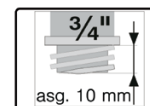

- Ensure that points of contact do not leak after you have made the connections.
- Flow of water with pressure of 0.1-1 Mpa will allow your machine to operate more efficiently (0.1 Mpa pressure means that more than 8 litres of water will flow through a fully-opened faucet per minute).
- Ensure that the new water inlet hoses are not bent, broken, crushed or resized.

**Note:** Use only the new water inlet hose coming with your machine when making the water inlet connections. Never use old, used or damaged water inlet hoses.

## Water draining connection

- Connect the water drain hose to a waste water drain hole or a special apparatus connected to the outlet elbow of the sink placed at a maximum height of 80 cm.

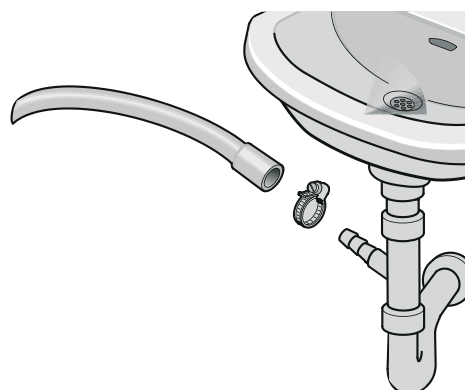

- Never attempt to extend the water discharge hose by jointing.
- Do not put your machine's water discharge hose into any container, bucket or bathtub.
- Make sure that the water discharge hose does not bend, buckle, get crushed or extended.

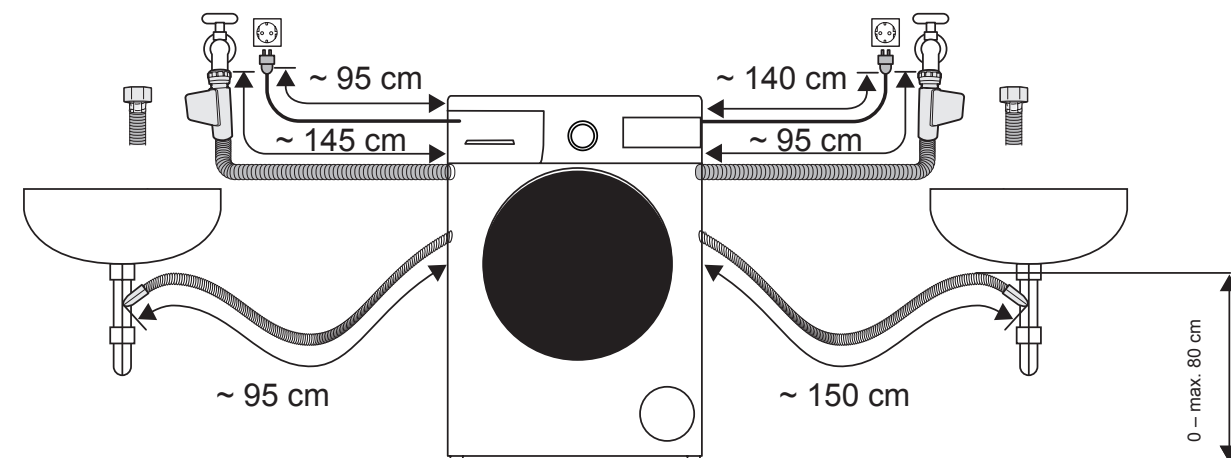

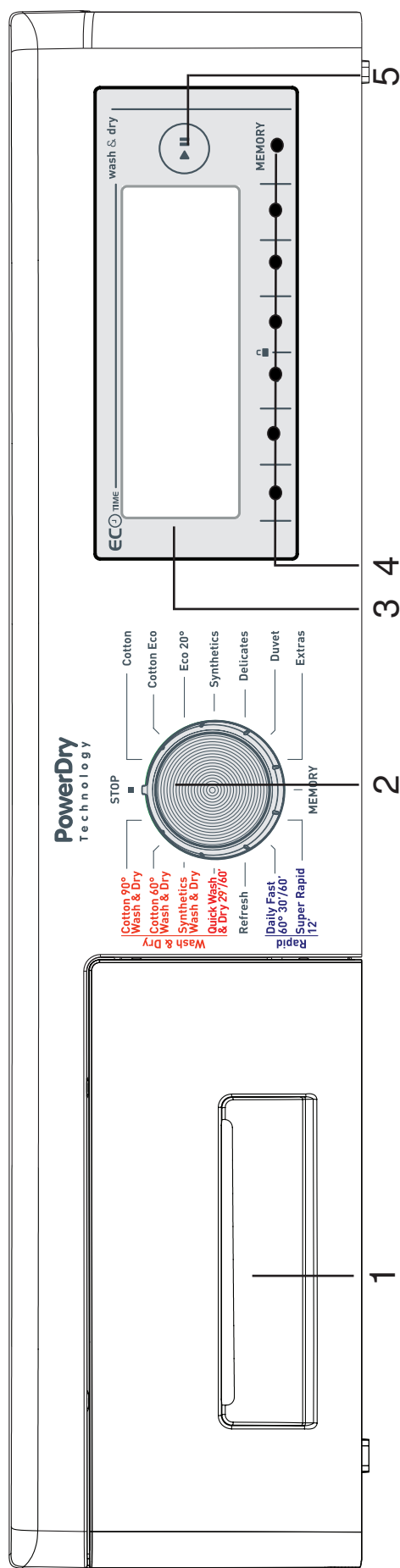

**1- Detergent drawer**

**2- Program knob:** You may select the programme you wish to use via the program knob. You may set the program selection operation by rotating the programme knob in both directions. Ensure that the programme knob is exactly on the programme you want to select.

**3- Info Screen:** In this screen, you can see the features of the washing or drying program you selected and also get information about the machine's status.

**4-Adjustment and additional function buttons:** The buttons on your machine are touch buttons. You only have to touch them lightly to make a selection.

**5-Start/Pause button:** You can start your machine and make it pause with this button.

## CONTROL PANEL

# Detergent drawer general view

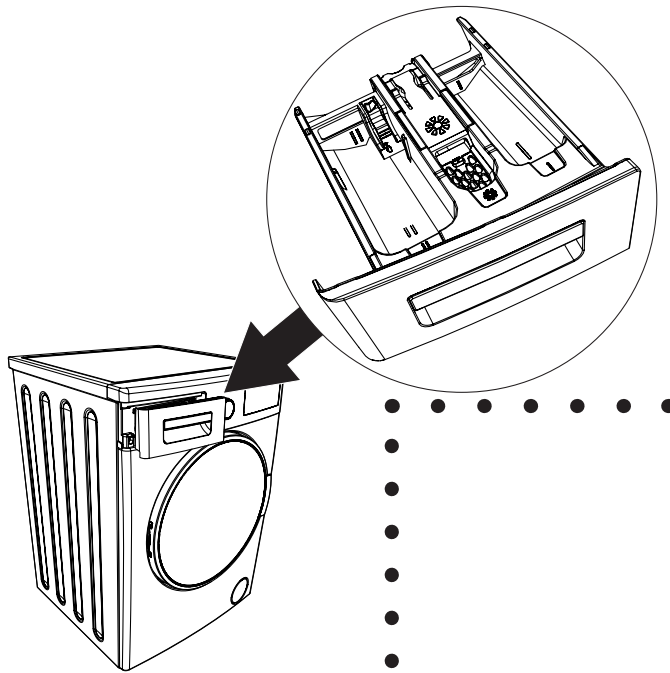

When you want to wash your laundry with liquid detergent, you can use the liquid detergent apparatus. You can use your liquid detergent in all programs without pre-wash. For this, plug the liquid detergent apparatus to second compartment of the detergent drawer (present in your machine) and adjust the liquid detergent amount (use liquid detergent in the amounts the detergent manufacturers foresee). Do not exceed the part that is labeled Max., use only for liquid detergent, remove this from its place during powder detergent use.)

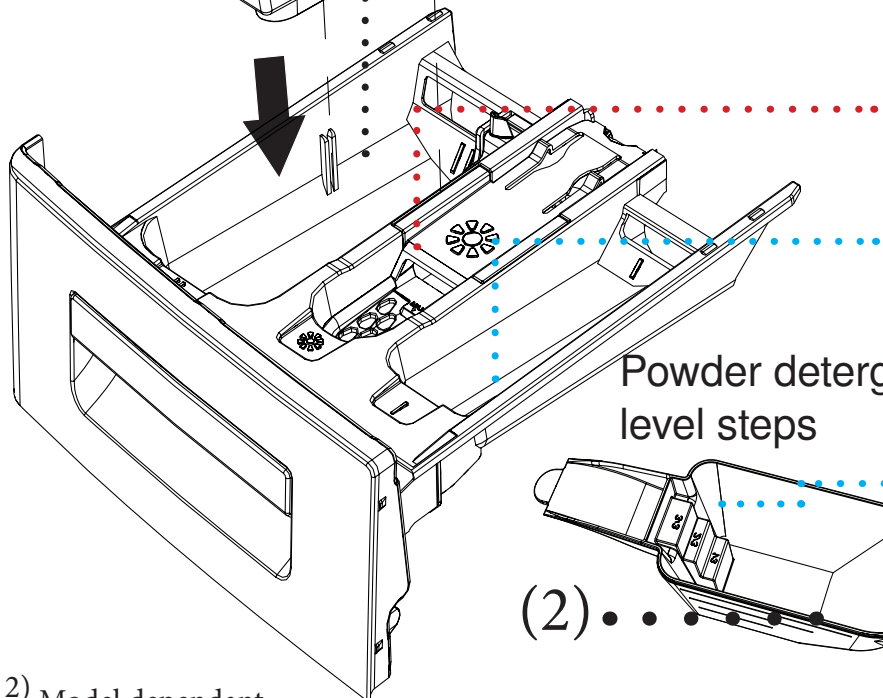
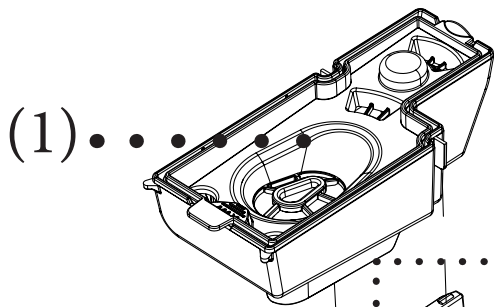

- Main Wash Detergent Compartment
- Softener Compartment
- Pre-Wash Detergent Compartment

Powder detergent level steps

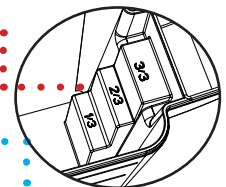

Powder detergent scoop

(2) . . . . .

(1\_2) Model dependant

# Detergent drawer compartments

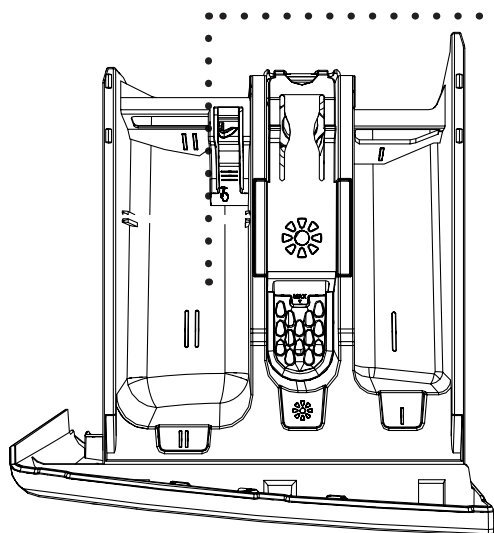

## Main wash detergent compartment:

In this compartment, only materials like detergent (liquid or powder) or anti-lime. You can find the liquid detergent apparatus for your liquid detergent inside your machine during the first set up. (\*)

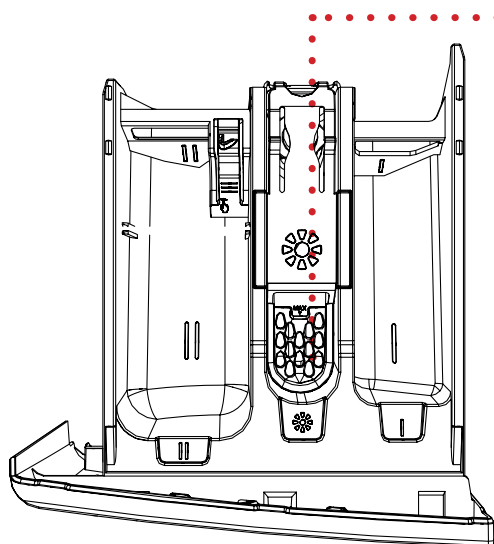

## Softener, starching, detergent compartment:

In this compartment, materials like softener for your laundry can be used (it is advised that you use the amount and type the manufacturer recommends). The softeners you use for your may sometimes remain in this compartment. The reason for this is that softener is not fluidal. To prevent this, it is recommended to use liquid softeners that are more fluidal or use the softener by diluting.

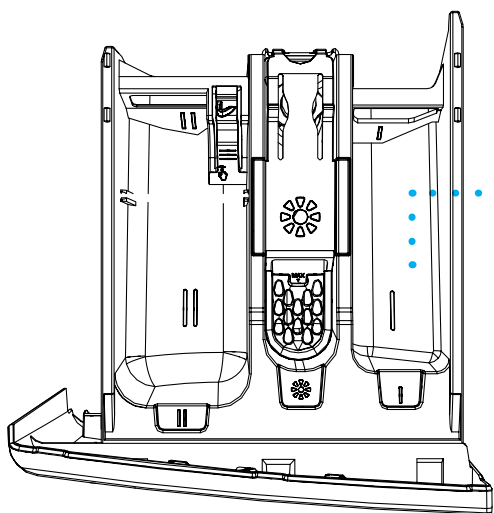

## Pre-Wash detergent compartment:

This compartment should be used only when pre-wash feature is selected. It is recommended that pre-wash feature used only for very dirty laundry. Please refer to page 99 for the maintenance of detergent drawer.

(\*) Model dependant

# Programme Knob

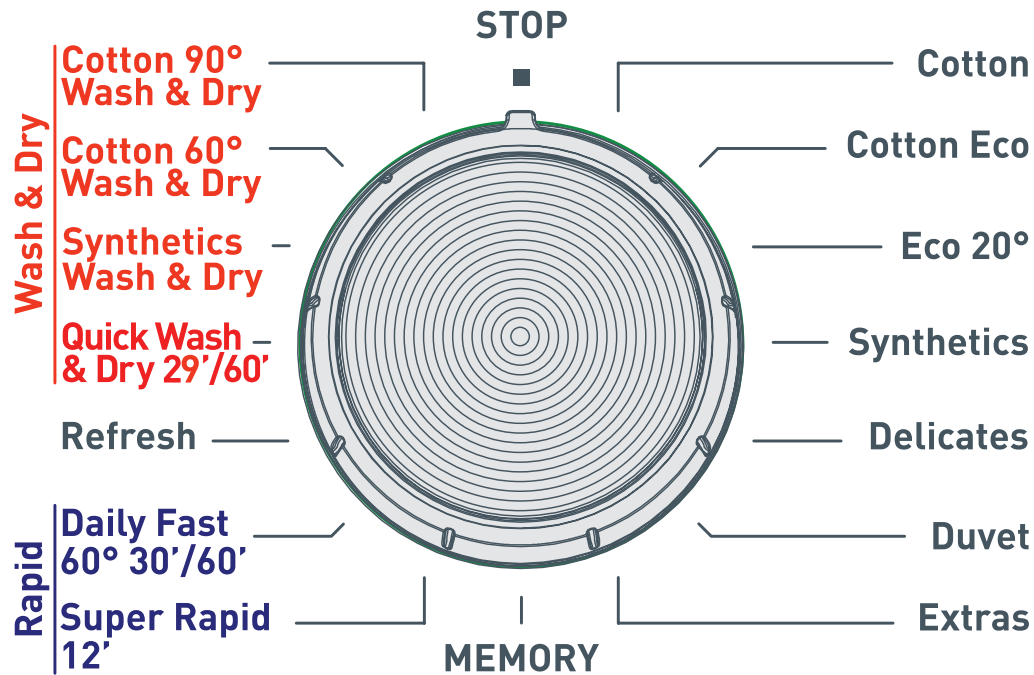

You can select the programme you want to wash your laundry in with the programme knob. You may set the programme selection operation by rotating the programme knob in both directions. Ensure that the programme button is exactly on the programme you want to select.

- You can see page (78) programme table for programme features.



# Adjusting machine settings



To make the first settings of your washer-dryer:

- Plug in your machine.
- Open the water tap.
- Turn the programme knob.

## Language selection setting

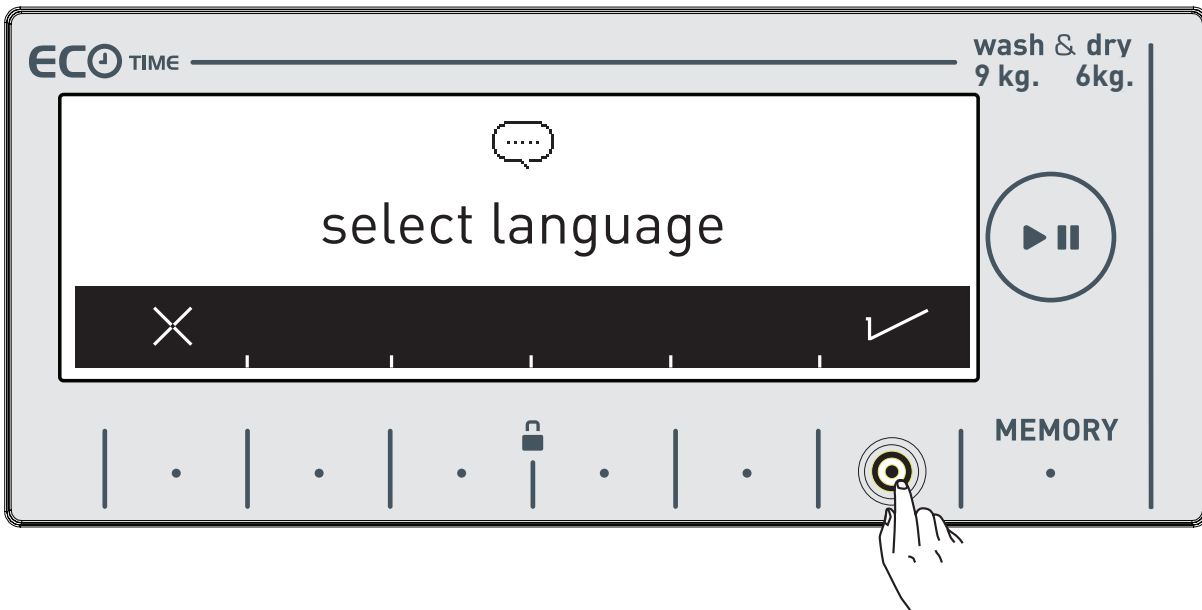
- The first thing that will be displayed on the main screen is the language selection setting.



- Go to the language you wish the use with the  symbol button.
- You can exit the language selection screen without making a selection with the  symbol button.

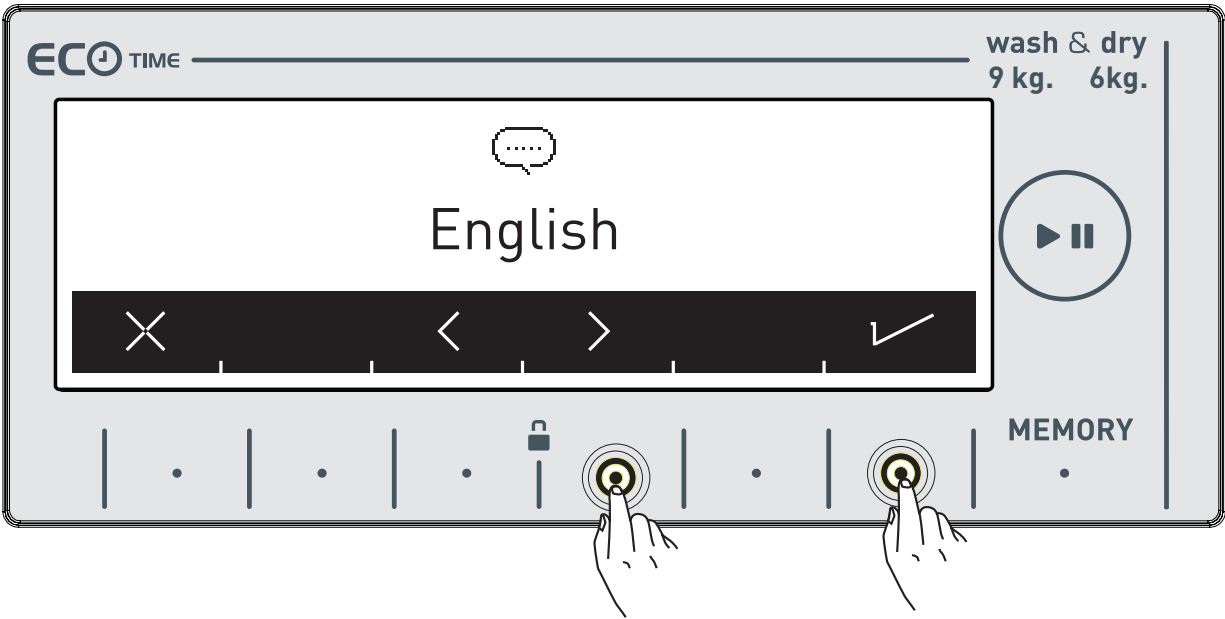

- Go to the language you wish the use with the < > symbol buttons.
- Approve your language selection with the ✓ symbol button.

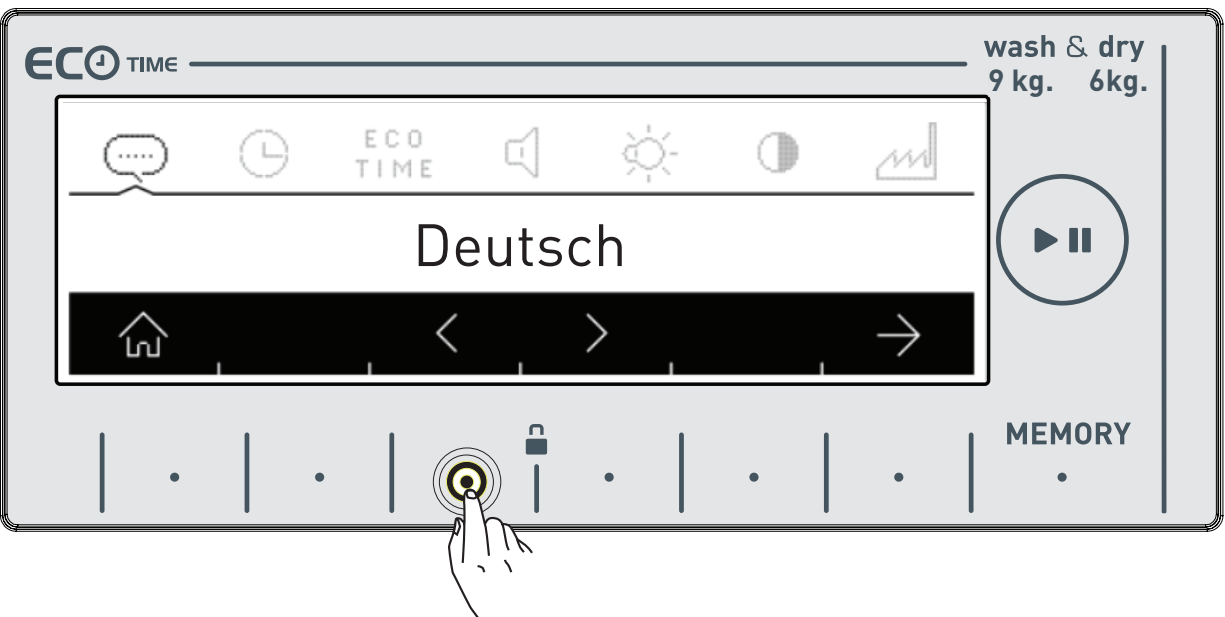

- When you want to change your language selection again, you can make the language selection by going into the language selection page and using the < > symbol buttons.

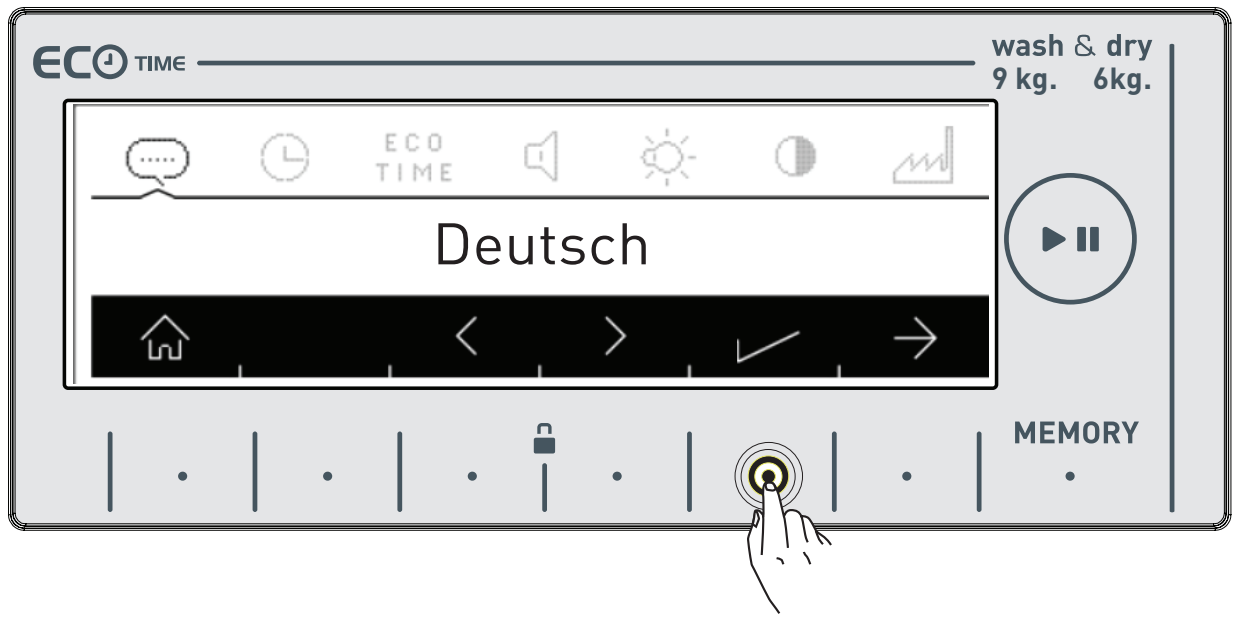

- Touch the ✓ button to save the language you selected.
- You will be asked to confirm the language selection on screen.

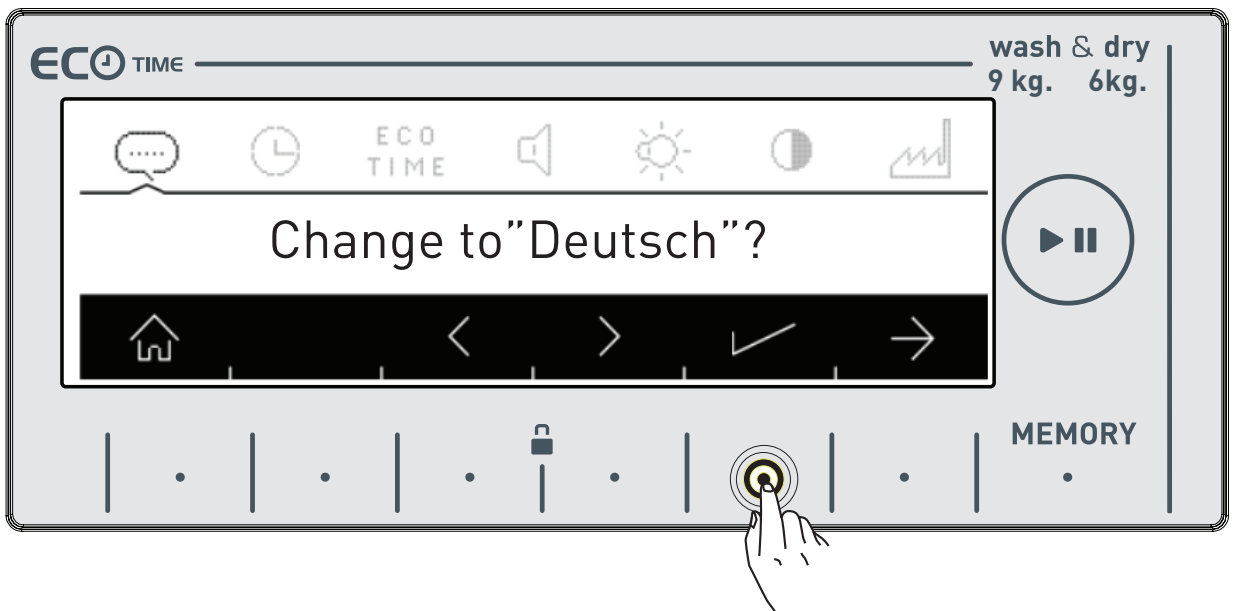

- Touch the ✓ button to approve the selection.

- If you believe you have selected the wrong language, touch the  button and re-make the language selection.
- When you approve the language change, the language you have selected will be active.

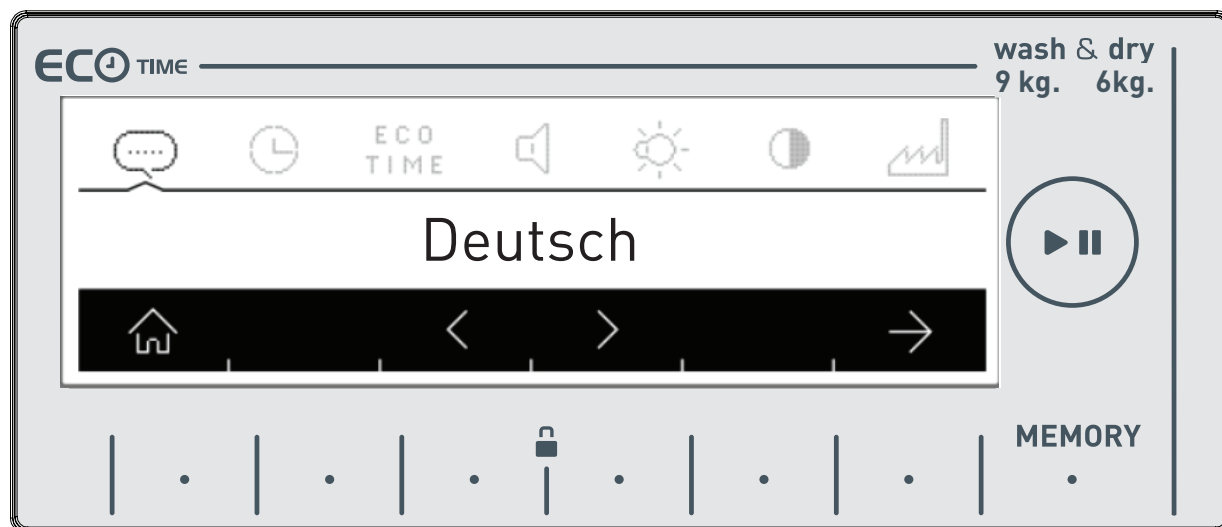

## ECO TIME **Eco Time Setting** (Economic time interval)

- The electrical energy consumption cost changes during the day according to the time intervals set by electricity providers. You can learn these intervals from electricity providers and set your eco time running hours, and have your machine run between these hours you determined.

**Note:** Your mains electricity must be connected to a counter with a smart-counter feature to be able to provide this energy saving.

- Touch the ✓ symbol button to make this adjustment.
- If you want to do it later, touch the ✕ symbol button.

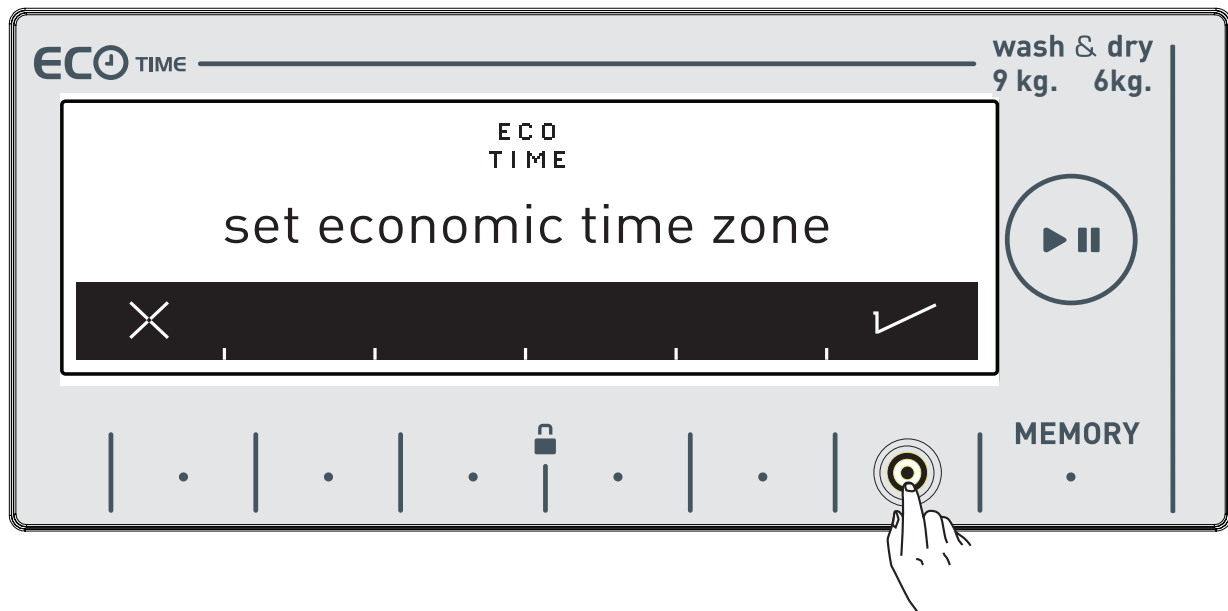

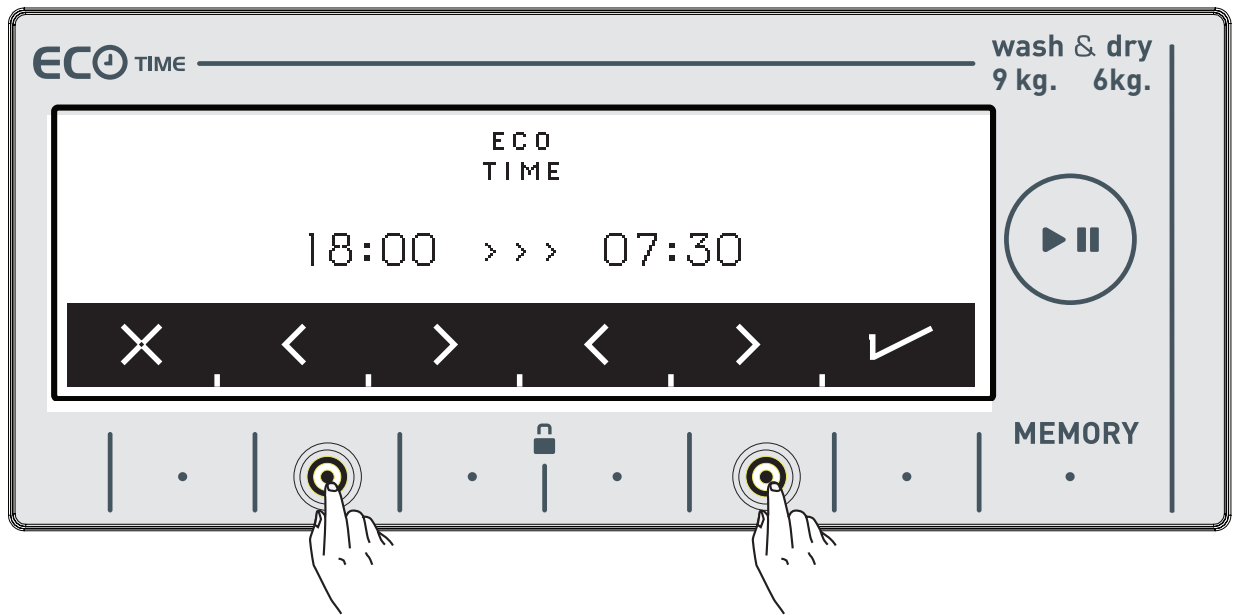

- You can adjust the Eco Time interval by touching the buttons of symbols < > See page 60 to activate the Eco Time interval additional function.

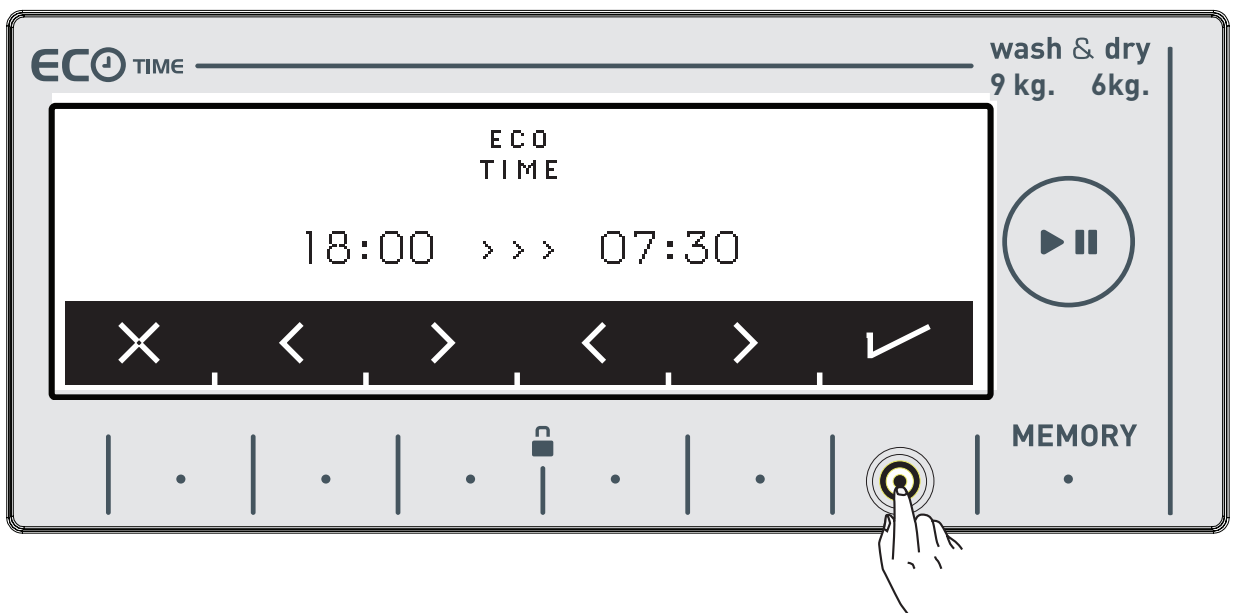

- Approve your selection by touching the ✓ symbol button.

## Current time setting

- We advise that you set the correct time at the point of installation.

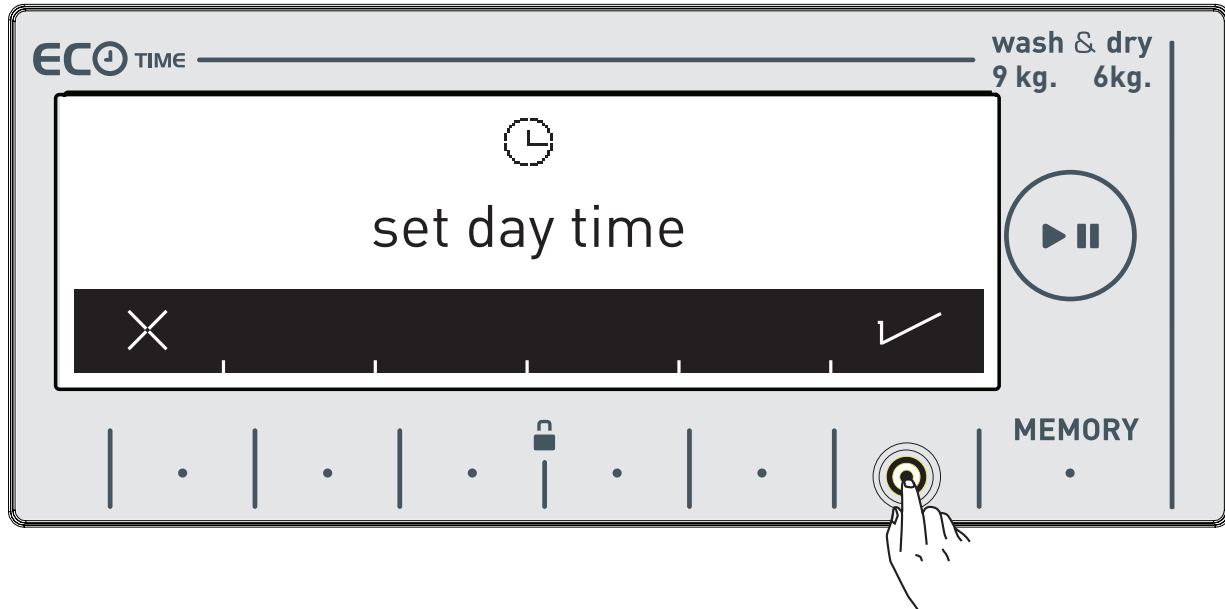

- Your machine will ask your approval for setting the current time. Go to the setting menu by touching the ✓ symbol button. ✕ symbol button allows you to exit without setting.

**Note:** You must set the current time correctly. Otherwise, operation of other related functions will be affected.

**Note:** Recorded time information will be reset if you keep your machine unplugged for longer than 15 days. In such a case your machine will ask you again for the time setting when you next turn it on.

- Please make the current hour and minute settings by touching the > > symbol buttons.

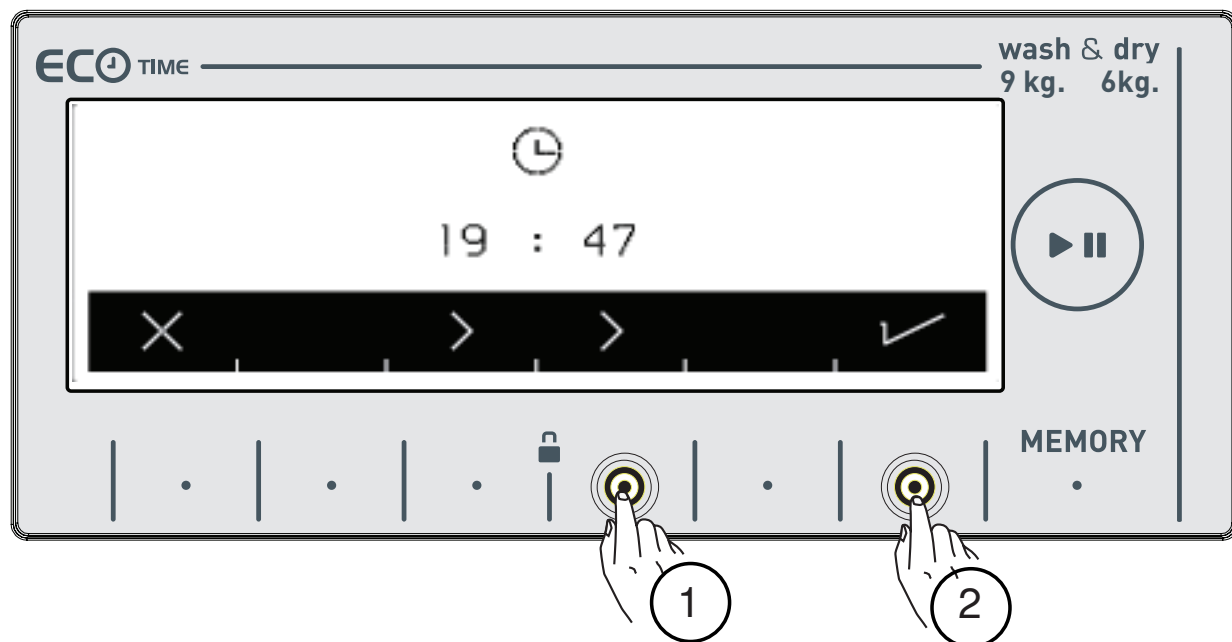

- After setting the current time, approve by pressing the ✓ symbol button.

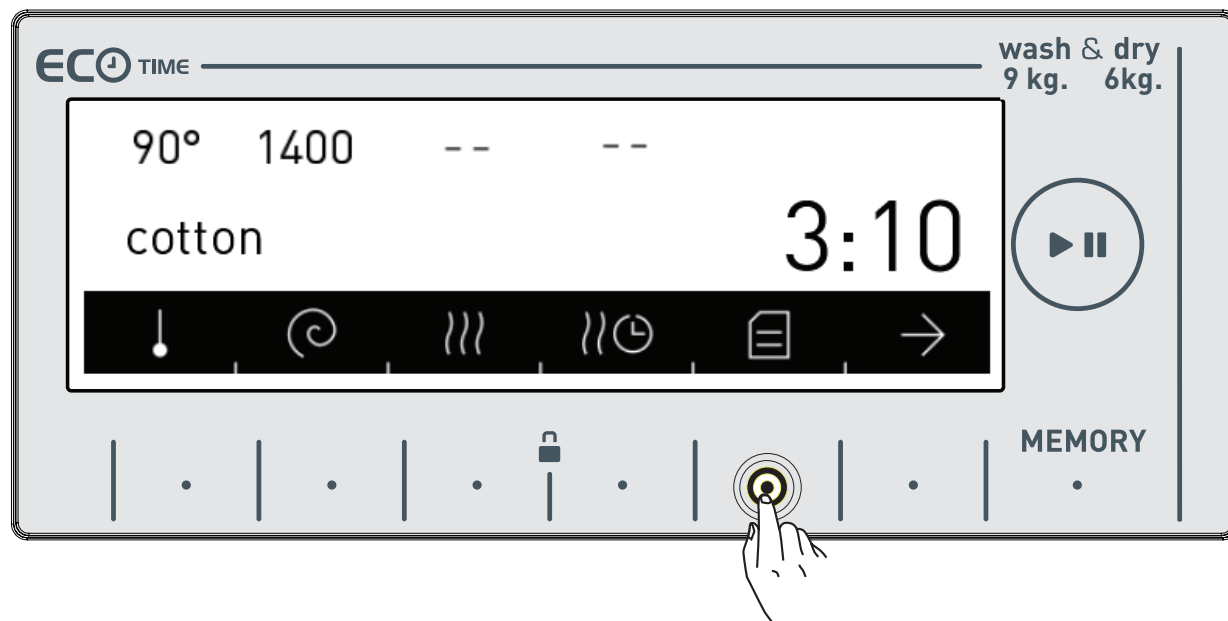



- Your machine will automatically go to the main screen of the programme you have selected. Go to the appliance settings menu by touching the button of  symbol on this screen.



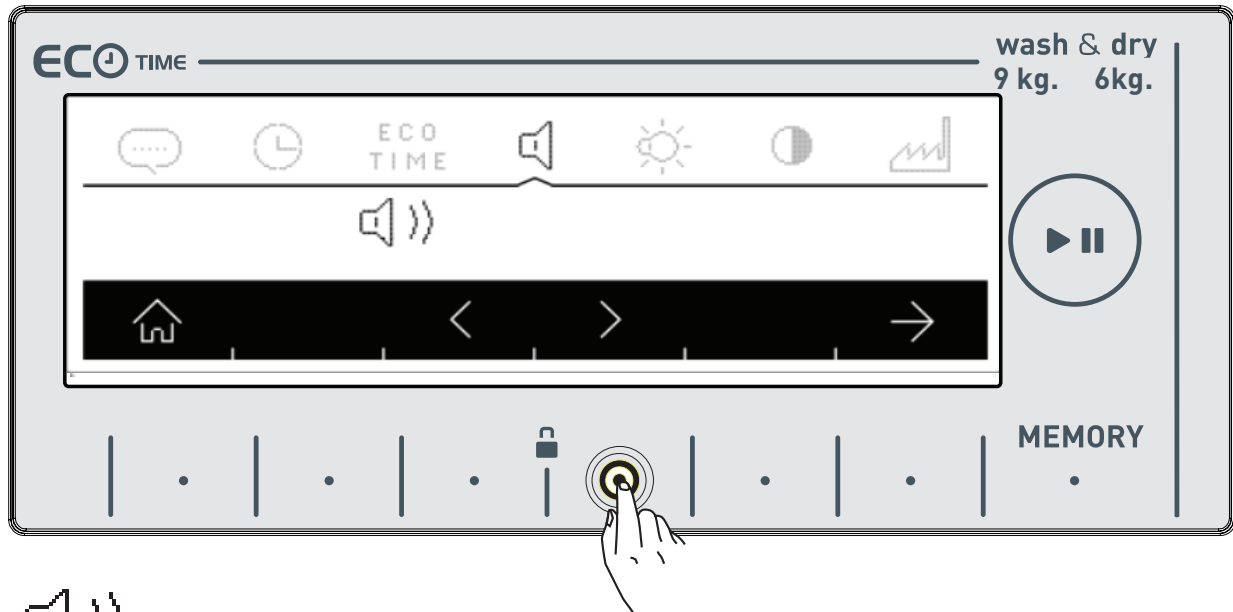

## Sound Adjustment

- You can make the sound adjustment of your appliance by pressing the < > symbol buttons.

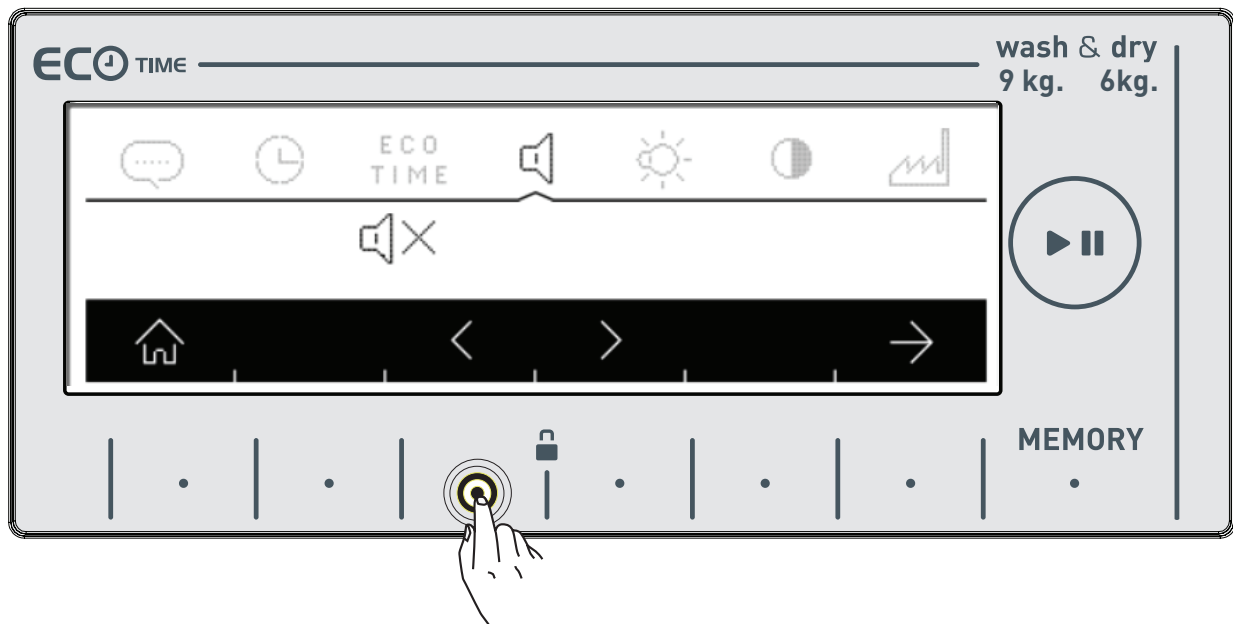

 symbol denotes that the warning sounds of your appliance is on.



 symbol denotes that the warning sounds of your appliance are off.

## Screen brightness setting

- You can adjust the screen brightness of your appliance by touching the < > symbols.

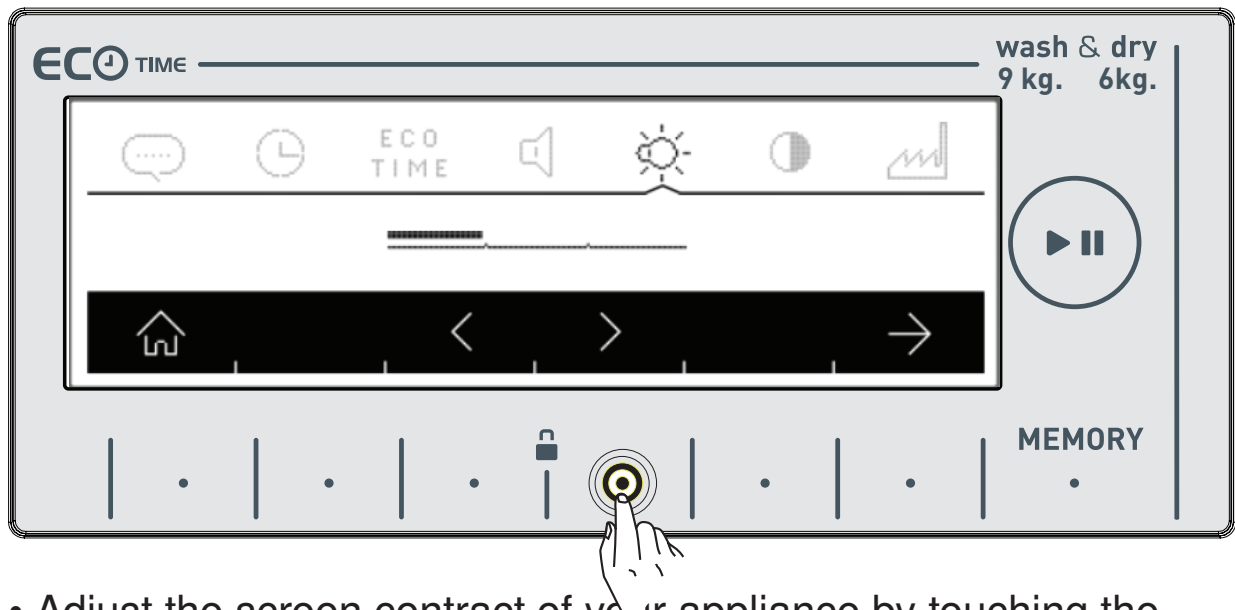

- Adjust the screen contract of your appliance by touching the  symbol button.

## Screen contrast setting

- You can adjust the screen contrast your appliance by touching the < > symbol buttons.

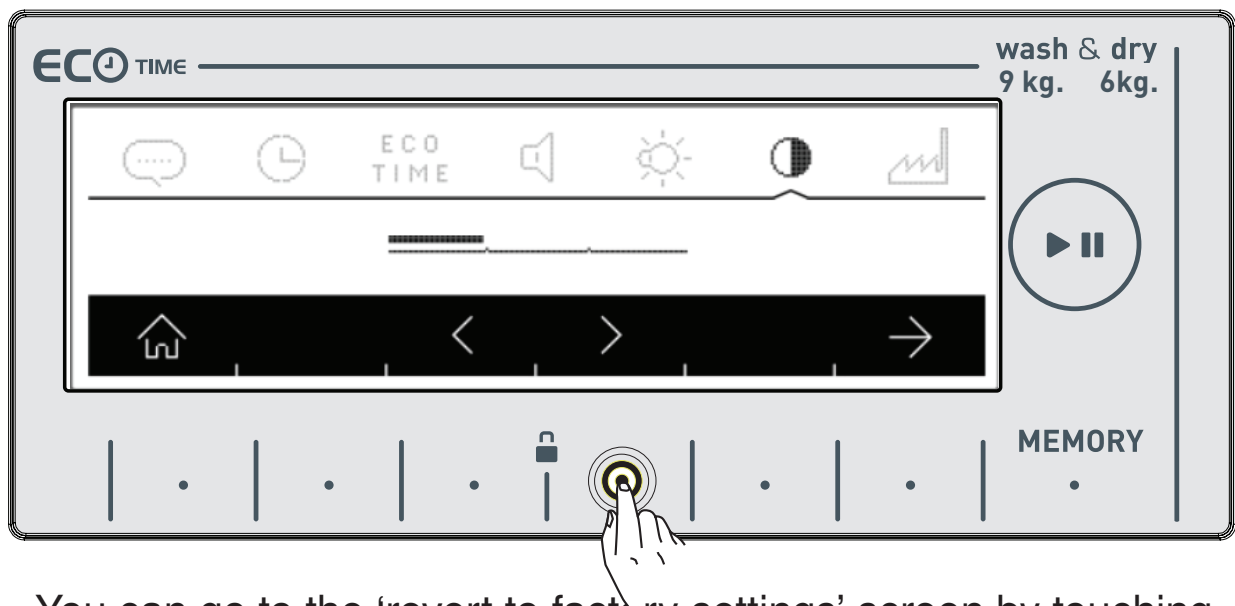

- You can go to the 'revert to factory settings' screen by touching the  symbol.

## Revert to factory settings



If you want to revert your appliance to the factory default settings:

- Touch the  symbol.



- You will be asked on screen if you want to reset to Factory Settings.



- Touch the  symbol to approve the selection.
- If you want to cancel the selection touch the  symbol.
- **You can return to the main screen by touching the  button.**

# WASHING OPERATION

- Open the tap.

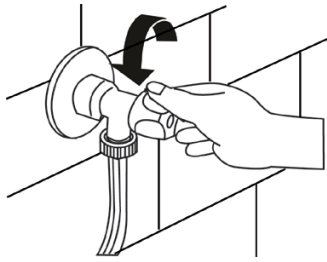

- Plug in your machine.

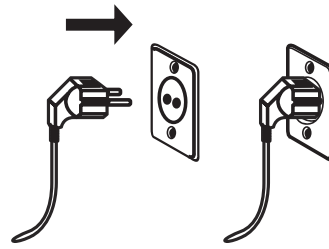

## Sorting laundry



Your laundry has product labels on them that specify their appropriate washing conditions. Wash or dry your laundry according to the specifications on the product label.

- Sort your laundry according to their type (cotton, synthetic, delicates, wool, etc.), washing temperature (cold, 30°C, 40°C, 60°C, 90°C), their level of dirtiness (less dirty, dirty, very dirty).
- Never wash your coloured and white laundry together.
- Wash your coloured laundries separately in the first washing as they may bleed.
- Ensure that there are no metallic materials on your laundries or in the pockets; if so, take them out.

**WARNING:** Any malfunctions occurring due to foreign materials getting in your machine are not covered by warranty.

- Zip up and button up your laundries.
- Remove the metallic or plastic hooks of curtains or place them in a washing net or bag and then muzzle them.
- Reverse textiles such as pants, knitwear, t-shirts and sweat suits.
- Wash socks, handkerchiefs and suchlike small laundries in a washing net.

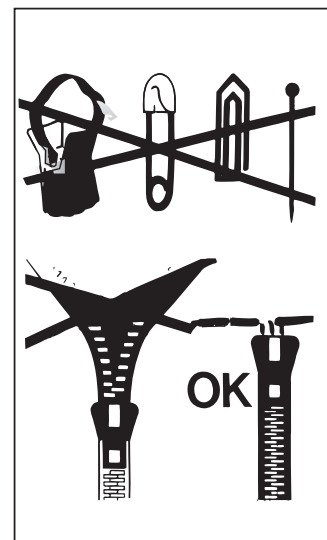

# Explanation of washing symbols

	Sturdy Material		Ironing temperature maximum 110 °C
	Delicates fabric		No ironing
	Maximum washing temperature is 95 °C		Can be dry cleaned with all kinds of solvents
	Maximum washing water temperature 60 °C		Can be cleaned only with perchloride, lighter gas, alcohol or R113.
	Maximum washing water temperature 40 °C		Can be cleaned only with perchloride, lighter gas, alcohol or R113.
	Maximum washing water temperature 30 °C		No dry cleaning
	Hand washing		Leave on flat surface
	Dry cleaning only		Hang when wet
	Can be bleached in cold water		Dry by hanging
	Do not use bleach.		Drying in normal temperature dryer
	Ironing temperature maximum 200 °C		Low temperature
	Ironing temperature maximum 150 °C		Do not dry in drying

## Placing laundry into the machine

 You must select a programme before loading your laundry into the machine. If you load laundry into the machine without selecting a programme, the load sensor will not be activated.

**Note:** The maximum load capacity of your machine may change according to the programme you select. Do not exceed the maximum dry loading capacity indicated in the programme table for washing programmes. If you exceed the load capacity of the programme you selected,  symbol will be displayed on the screen of your machine and your machine will warn you with sound. It is advised that you remove laundry from your machine until this symbol disappears.

- Open the loading door of your machine.

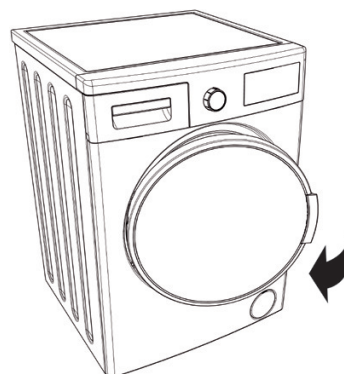

- Check inside the drum of your machine. There might be laundry left inside from previous washes. If there is, empty your machine before selecting your programme.

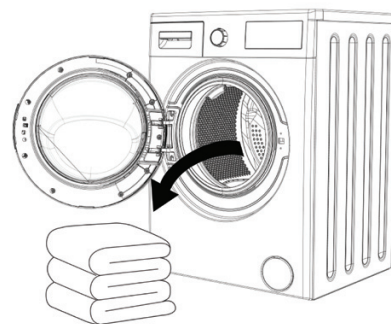

- Place your laundry into the machine by spreading them well. Fold objects like quilts and blankets that you will load into the machine as shown below.

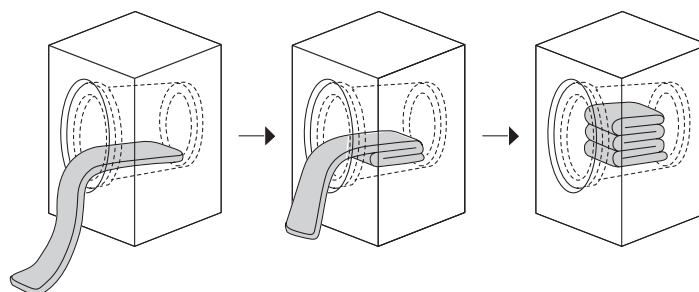

- There is a load detection system in your machine. The load detection system measures the weight of the laundry inside your machine and informs you by the moving sticks on the electronic screen and automatically adjusts the programme features (programme duration, energy consumption, water consumption etc.) according to the load amount.
- If you continue to operate your washing machine whilst overloaded, washing and drying performances will be affected. Additionally, your washing machine can be damaged and you may see your clothes get yellow after drying programs.

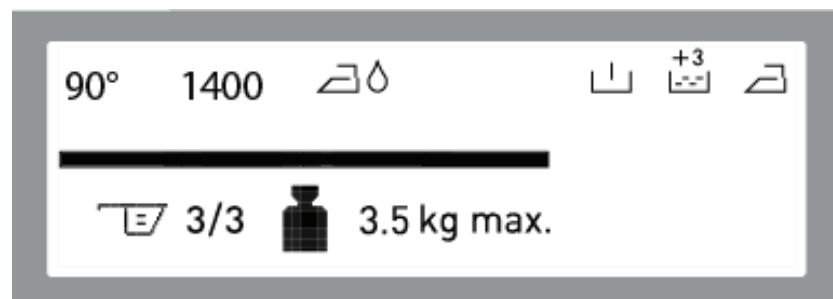
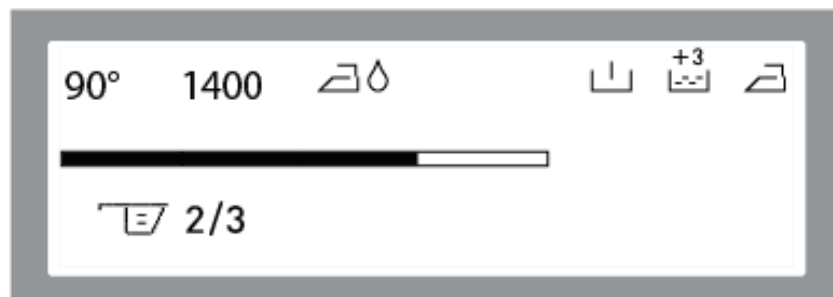
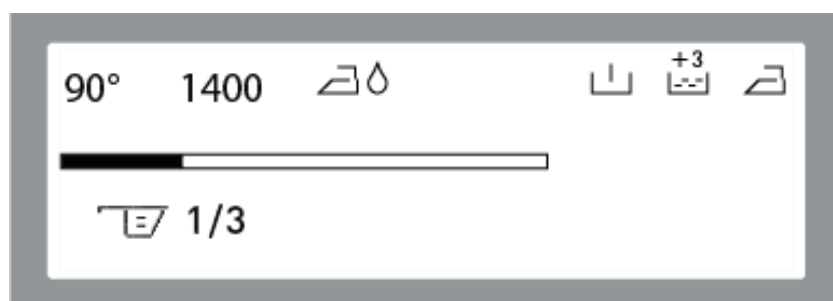

- Put each item of laundry separately.
- Ensure that no laundry is stuck between the cover and bellow seal when closing the door of your machine.
- Ensure that the machine door is completely closed.
- Tightly shut the door of your machine or the machine won't start the washing operation.

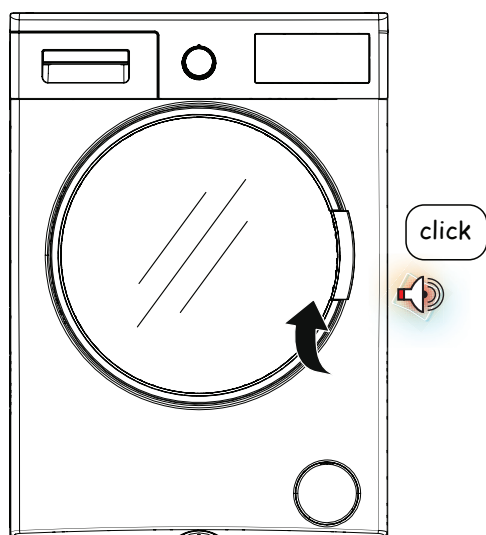



## Choice of detergent and placing into the machine

The amount of detergent you will put in your machine will depend on the following criteria:

- Your detergent utilization will be based on the degree of contamination of your laundries.
- Do not prewash your less stained laundries and put the correct amount of detergent in the 2nd compartment of the detergent drawer.
- The Pre-wash feature might be used for your very dirty laundry. If you are going to do a pre-wash, place 1/4 of the detergent you would normally put in the detergent compartment into the compartment numbered 1, and put the remaining 3/4 to the compartment numbered 2.
- Use detergents produced for automatic washing machine in your machine. Adhere to the advice of detergent manufacturers while determining the amount of detergent you should use with your laundry.
- The higher the degree of hardness of the water the more detergent you will use.
- The amount of the detergent you will use will increase as the amount of your laundry increases.
- Put the softener in the softener compartment in the detergent drawer. Do not exceed the MAX level. Otherwise, softener will flow into washing water through flushing.
- Softeners with high density are required to be thinned to a degree before being put in the drawer. Because high-density softener will clog the flush and block the flow of the softener.
- You can use your liquid detergent in all programs without pre-wash. For this, plug the liquid detergent apparatus to second compartment of the detergent drawer (present in your machine) and adjust the liquid detergent amount (use liquid detergent in the amounts the detergent manufacturers foresee). Do not exceed the part that is labeled Max, use only for liquid detergent, remove this from its place during powder detergent use.)

For positioning detergent apparatus in the detergent box, see the page 29.(\*)

(\* )Model dependant

- Your machine has a system that advises the detergent amount (dose) according to the laundry amount you will load. This system is shown by the  symbol found on the electronic screen.

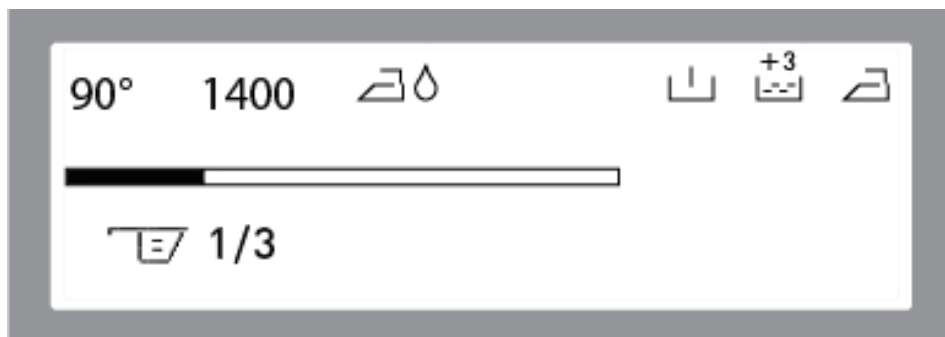

**Note:** 3/3 means a completely full detergent drawer. The amount of the detergent on the screen should be appropriate with the same amount that you put into your washing machine by detergent shovel.

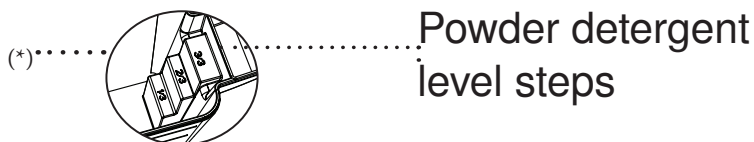

**If you are going to select a washing or drying programme, do not place a detergent dosage adjustment device/ball in your machine. They might pose a fire risk.**

(\*)Model dependant

## Program selection

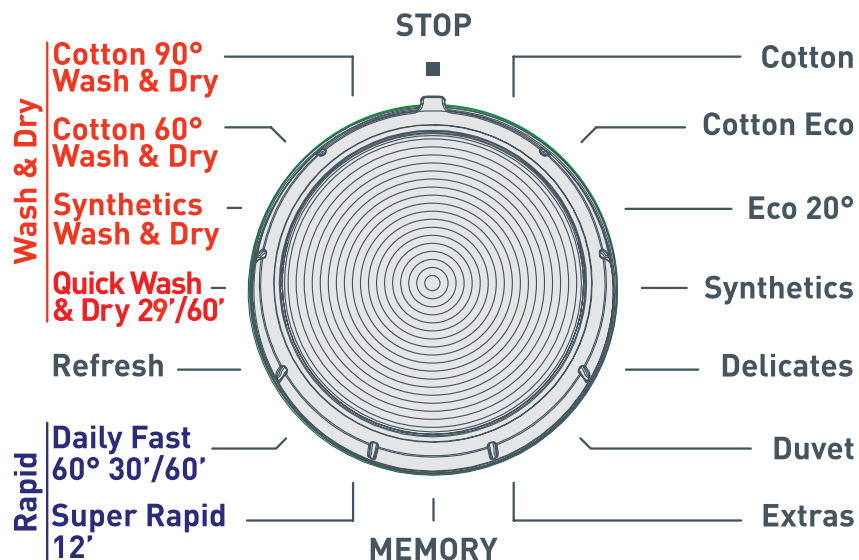

- Select the washing programme you desire by the programme knob.

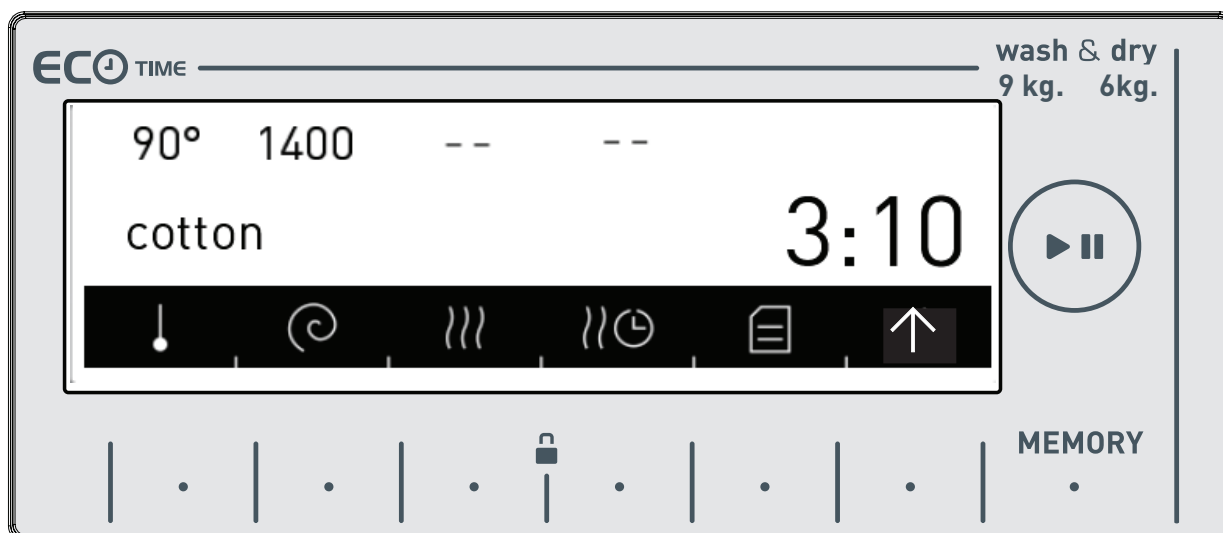

- The programme name and features will be shown on the screen.



- You can make the temperature adjustment (\*, 20°, 30°, 40°, 60°, 90°) by touching the  symbol button.

- You can make the spinning adjustment (, 400, 600, 800, 1000, 1200, 1400) by touching the  symbol buttons.



**Note:** After setting the spin speed, if you select a drying programme, your machine shall set the spin speed automatically to enhance drying performance.

- You can see page (78) of the programme table for programme features.

## If you want your laundry dried at the end of washing

- You can select the drying setting you wish to use by touching the  symbol button.



### **Cupboard dry**

- Recommended for laundry that you will put in the cupboard directly.
- If you want to select the cupboard dry feature, touch the  symbol button until you see the  symbol on the screen.

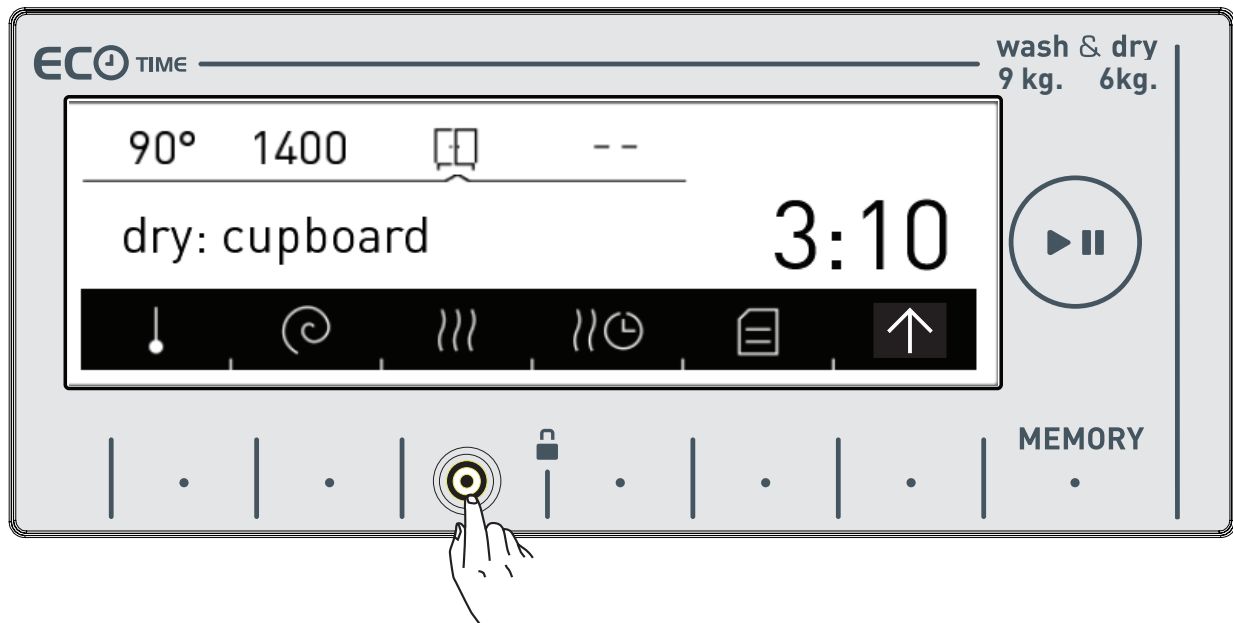
**Note:** If the  symbol does not appear on the screen when you want to select the cupboard dry function, it means this drying feature is not used in the washing programme you selected.





## Hanger dry

- Recommended for laundry that requires hanger drying.
- If you want to select the hanger dry feature, touch the symbol  button until you see the  symbol on the screen.

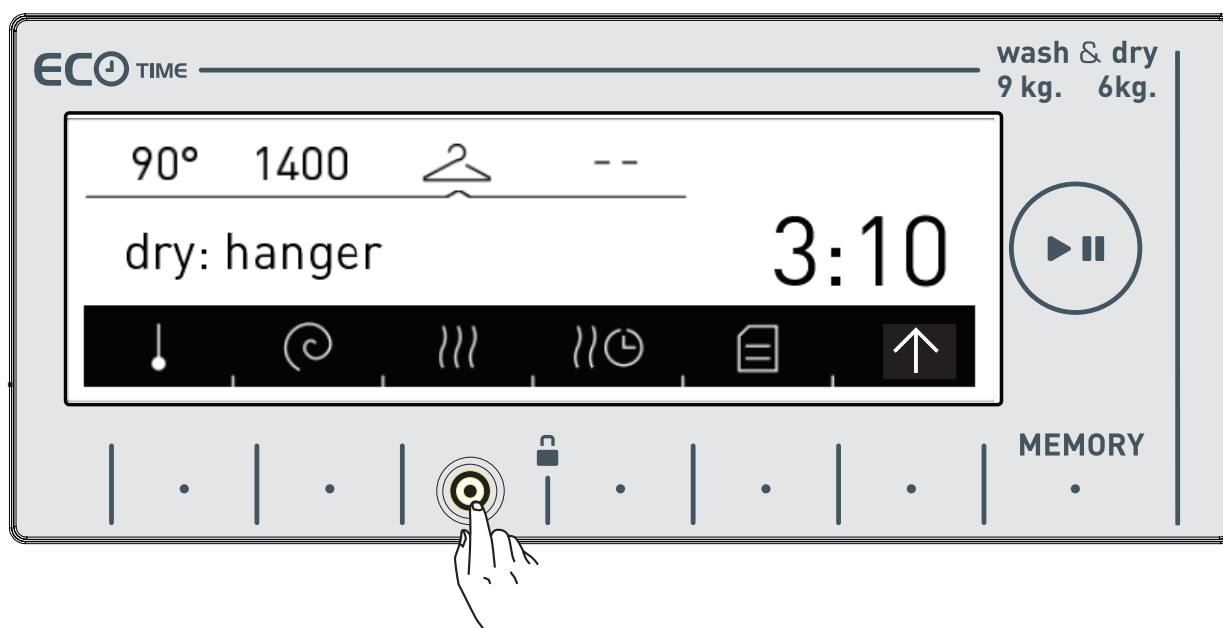
**Note:** If the  symbol does not appear on the screen when you want to select the hanger dry feature, it means that the washing programme you selected does not use this drying feature.



## Iron dry

- Recommended for laundry that you will iron before use.
- If you want to select the iron dry feature, touch the  symbol button until you see the  symbol on the screen.

**Note:** If the  symbol does not appear on the screen when you want to select the iron dry feature, it means that the washing programme you selected does not use this drying feature.

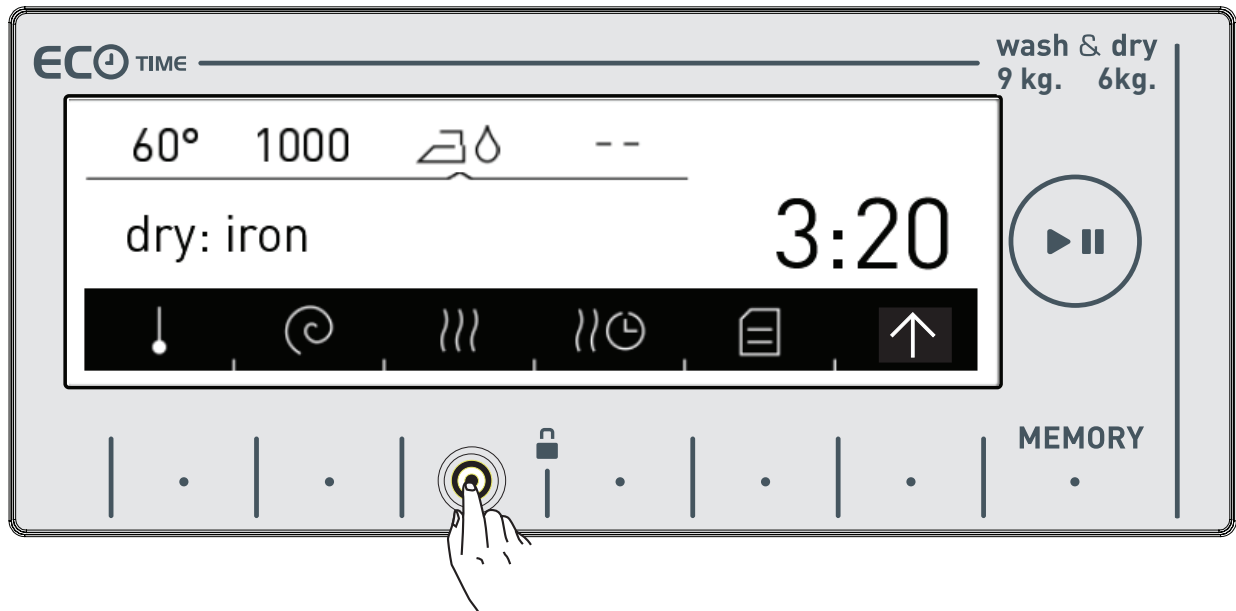

## ☰🕒 Drying with duration

If you want to use a time-set drying programme;

- Touch the ☰🕒 symbol on the screen.
- Drying selections will be displayed on your machine screen as 30, 60 and 120 minutes.

**Note:** If one of the 30<sup>min</sup> 60<sup>min</sup> 120<sup>min</sup> symbols are not displayed on the screen when you wish to select the duration drying feature, it means this drying feature cannot be used in the programme you selected or the load amount in the machine is not appropriate for that duration of drying.

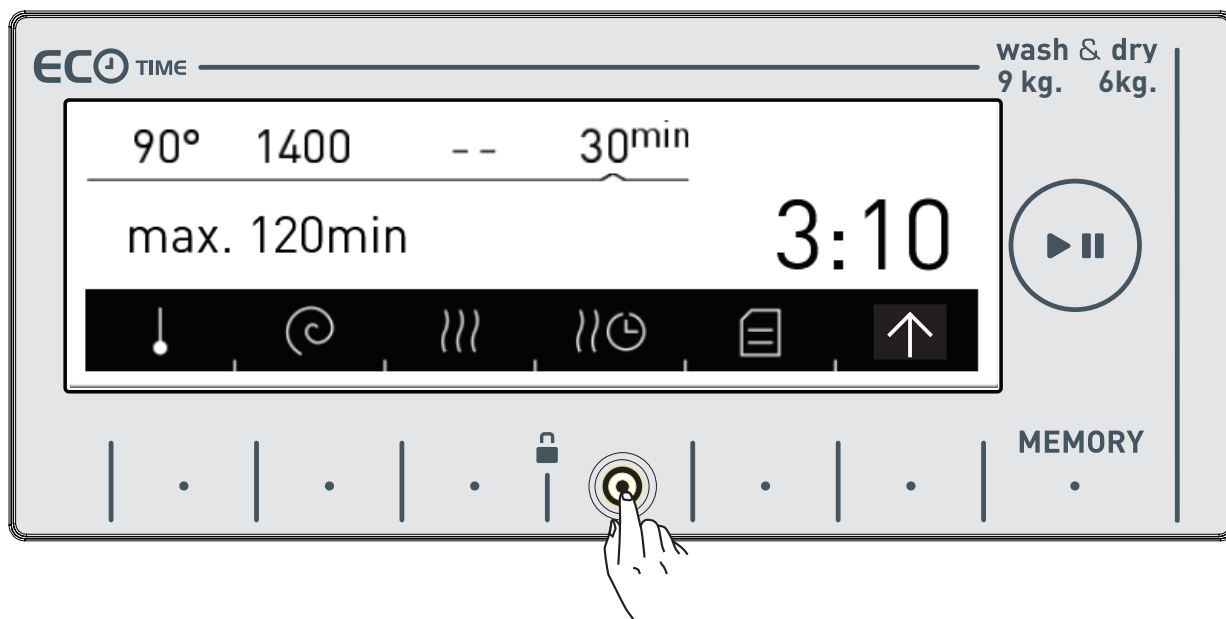

### Duration Drying Programs

Amount of laundry to dry	Recommended drying time
1 kg	30 minutes
2 kg	60 minutes
3,5 kg	120 minutes

If the amount of laundry to be dried is above 3,5kg, it is advised that one of the options of Cupboard, Hanger or iron drying is selected.

## Additional Functions

Before starting the programme, you can optionally select an additional function.

- Press the button of an additional function you would like to select.

Additional functions may not be available due to the programme you selected or the amount of laundry you put in your machine.

Why an additional function may not be available:

- It is not compatible with a function you have selected previously.
- There may not be enough time left on the current programme to carry out the additional function you wish to select

- You can see the programme table in pages between 78-89 for the additional functions used in programmes.





- Touch the  symbol button to arrive on the additional function view.



## Pre-wash additional function

You can give your heavily soiled laundry a pre-wash before the main wash using this function. When using this function, you should put detergent in the front washing compartment of the detergent drawer.

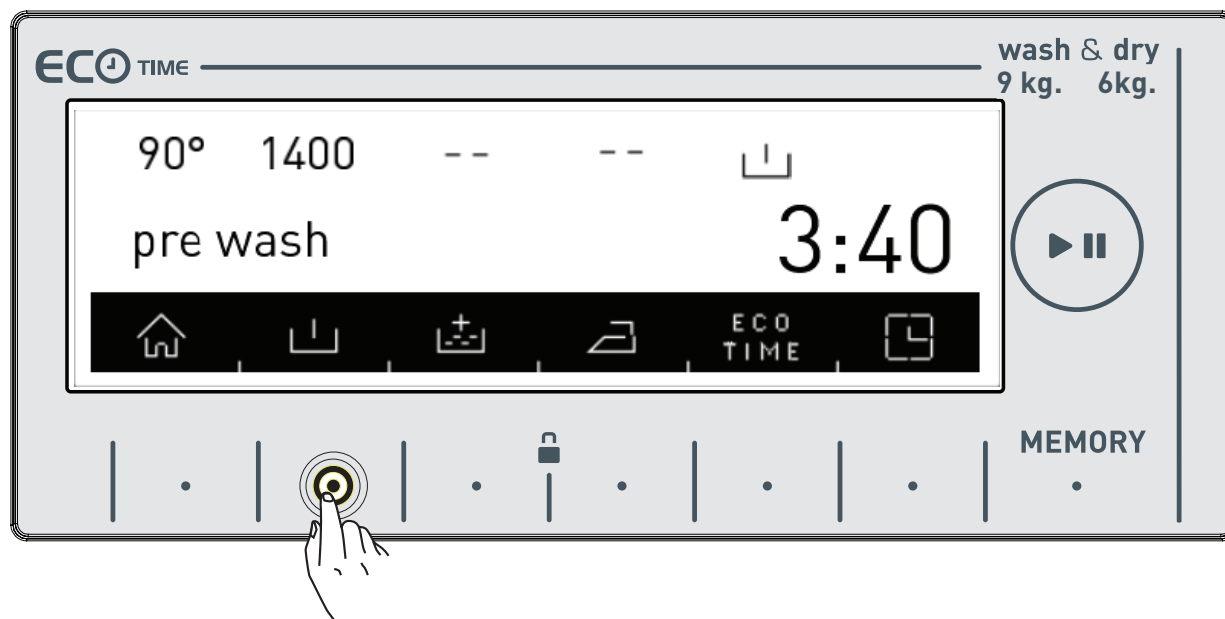

- Touch the  symbol button to activate the pre-wash additional function.

**Note:** If the  symbol is not displayed on the screen when you want to choose the pre-wash additional function, it means that this feature can not be used in the washing programme you selected.



## Extra rinse function

You can add an additional rinse or rinses to your laundry by using this function. Your machine offers you 3 rinsing options for this additional feature.

-  : One additional rinse is made at the end of washing.
-  : Two additional rinses are made at the end of washing.
-  : Three additional rinses are made at the end of washing.

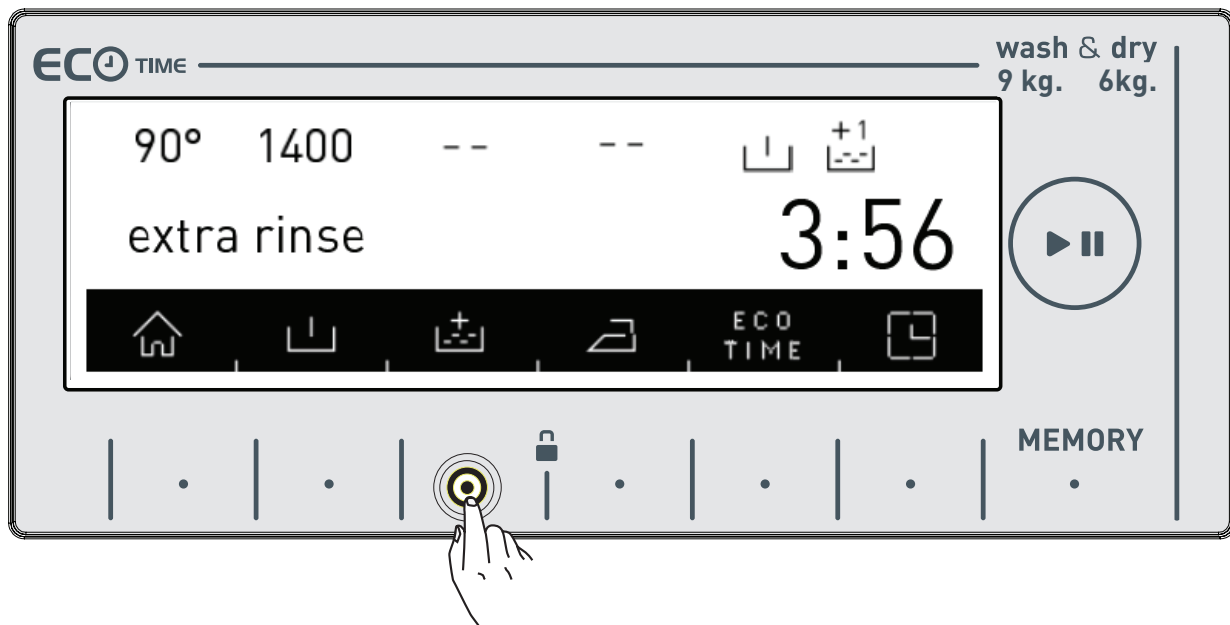

- If you want to make more than one rinsing, touch the  symbol button until you see the number of rinses you wish.

**Note:** If the  symbol is not displayed on the screen when you want to choose the additional rinsing function, it means that this feature is not used in the washing programme you selected.



## + A Anti-allergic additional function

You can add this additional rinse operation to your laundry by using this function. Your machine will carry out all rinsing steps with hot water (it is recommended for laundry worn on delicate skin, baby clothes, underwear)

- Touch the  symbol button until you see the  symbol to activate the anti-allergic additional function.

**Note:** If the  symbol is not displayed on the screen when you want to select the anti-allergic additional function, it means that the washing programme you selected does not use this feature.

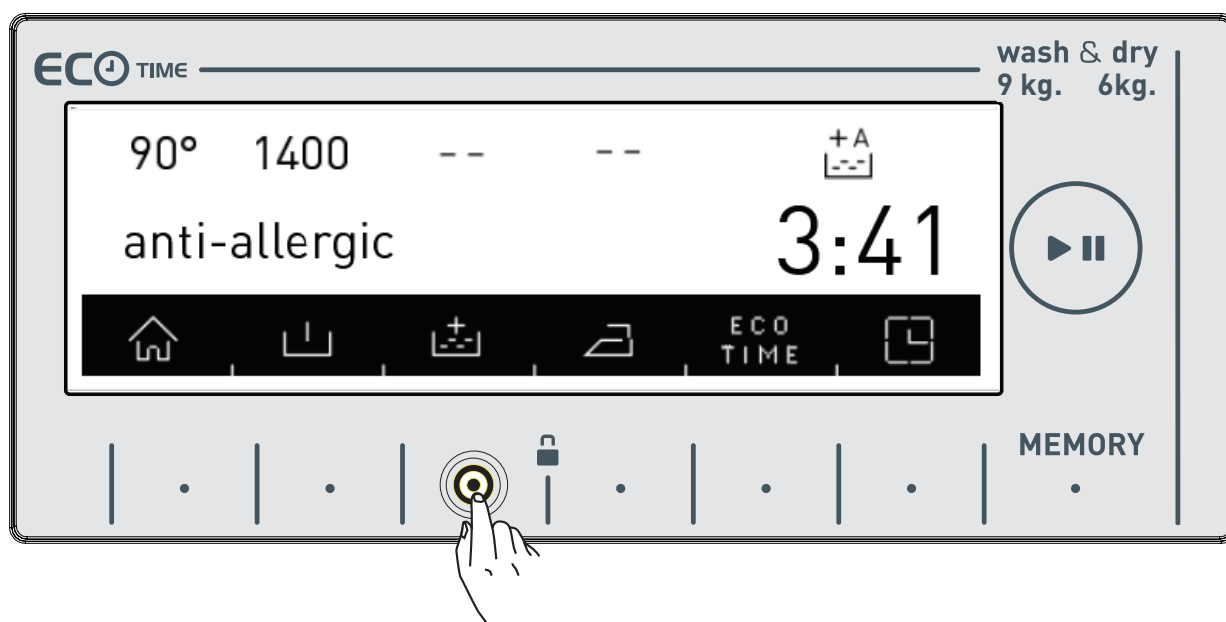

## Easy ironing additional function

- You can make your laundry be less wrinkled at the end of the wash by using this additional function.
- Touch the  symbol button to activate the easy ironing additional function.

**Note:** If the  symbol is not displayed on the screen when you want to select the easy ironing additional function, it means that the washing programme you selected does not use this feature.

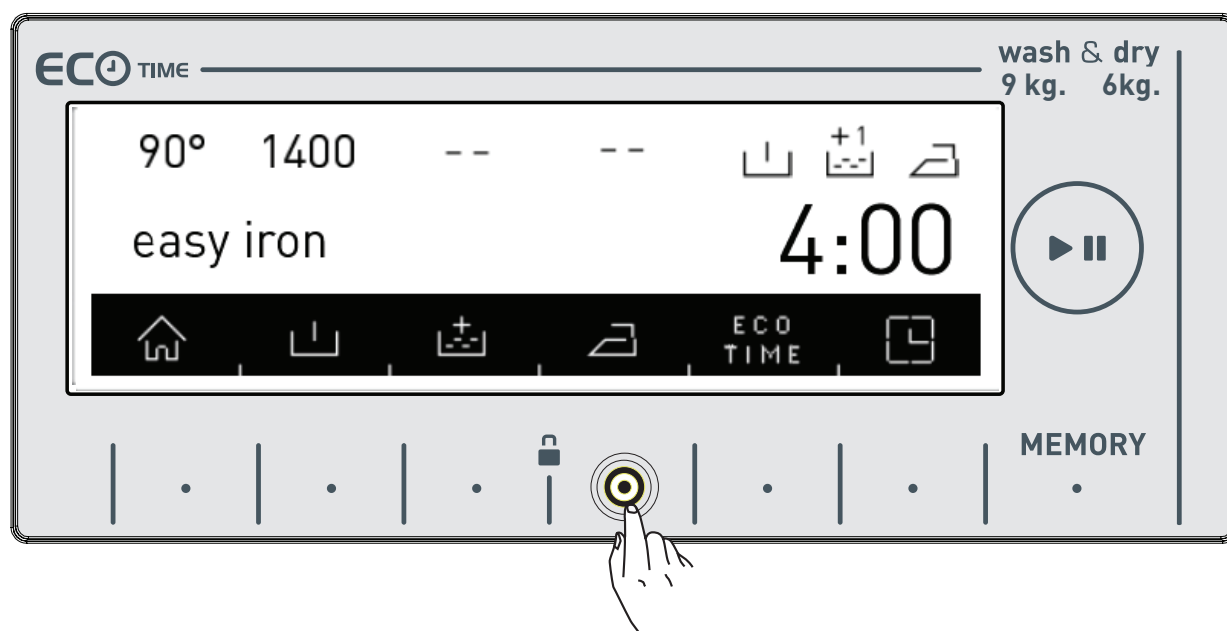

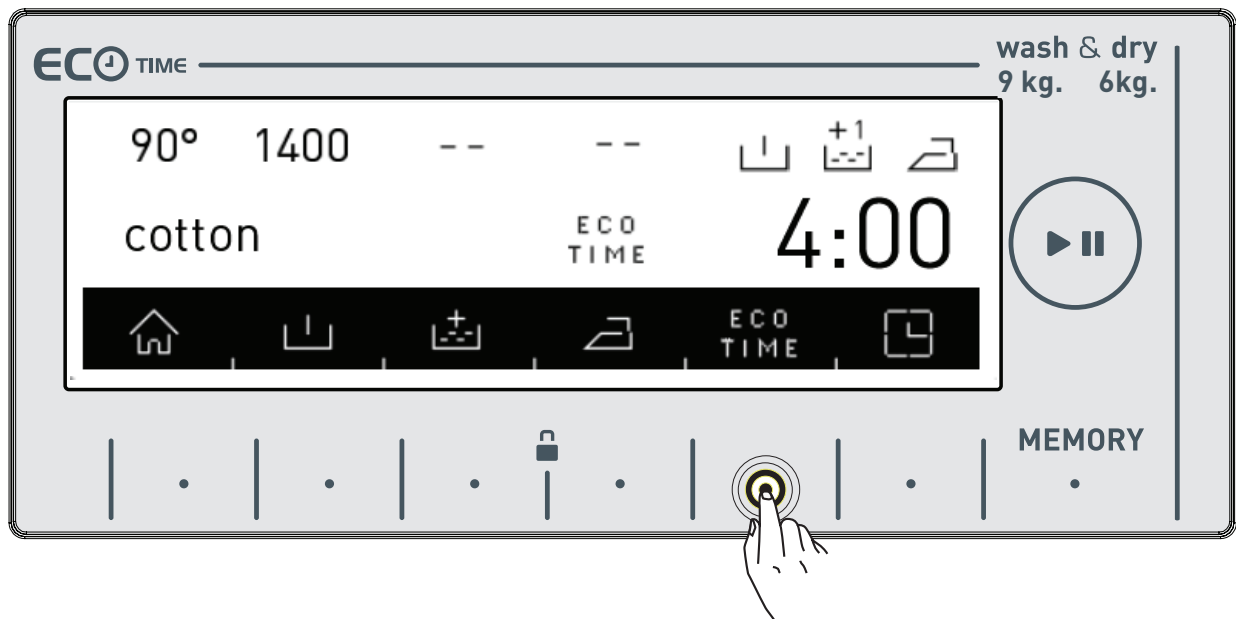

## **ECO TIME** Economic time interval additional function

- You must make the Eco Time setting from the settings section for this function to work efficiently (see page 36).
- If you want to activate the Eco Time function touch the button of **ECO TIME** symbol.
- You will see **ECO TIME** symbol is activated on the screen.

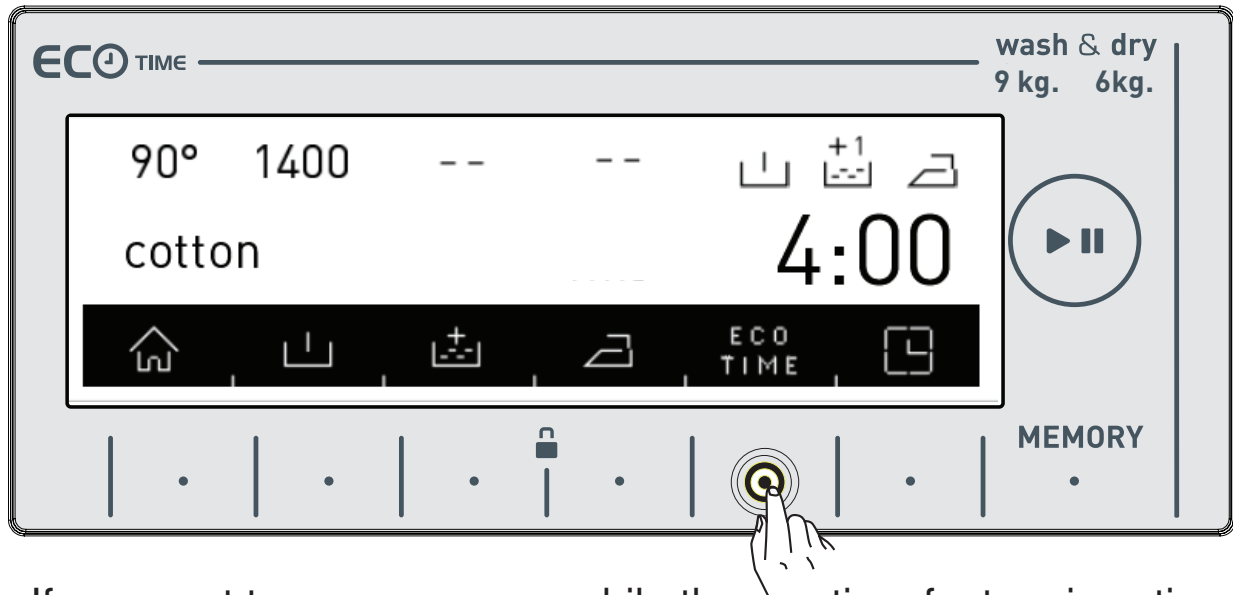

- The Eco Time feature will be constantly displayed on the screen until it is shut off. To shut off, the eco time additional function button must be pressed.



- If you want to run a program while the eco time feature is active, touch the button of  symbol. The starting time of the programme will automatically be delayed until the economic time interval. The programme “starting time” and the programme duration will be shown on the display with certain intervals.



- If you don't want to run the programme you have selected between the eco time hours, touch the  button again. "eco time cancelled" text will be displayed on the screen.



- Your machine will return to the main screen of the programme you have selected in 3 seconds. To start the programme, run the programme you selected by touching the start/pause button.

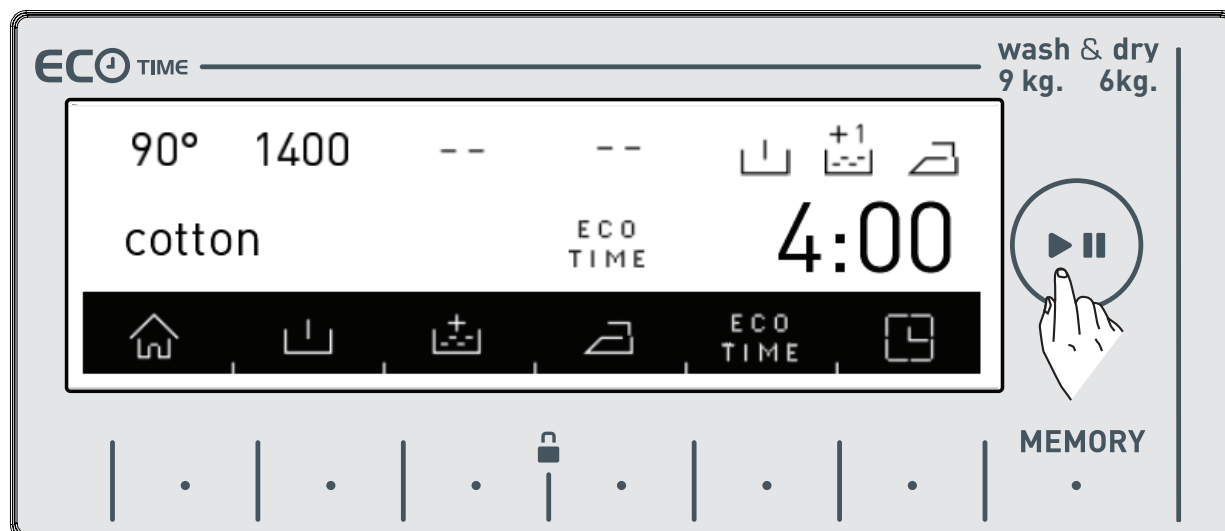

## Delay Time / Finish time adjustment additional function

- By using this function, you can delay your machine starting the washing operation by 10 minutes up to 23 hours 50 minutes or you can set the wash to finish at a certain time.
- To activate this additional function, touch the  symbol.

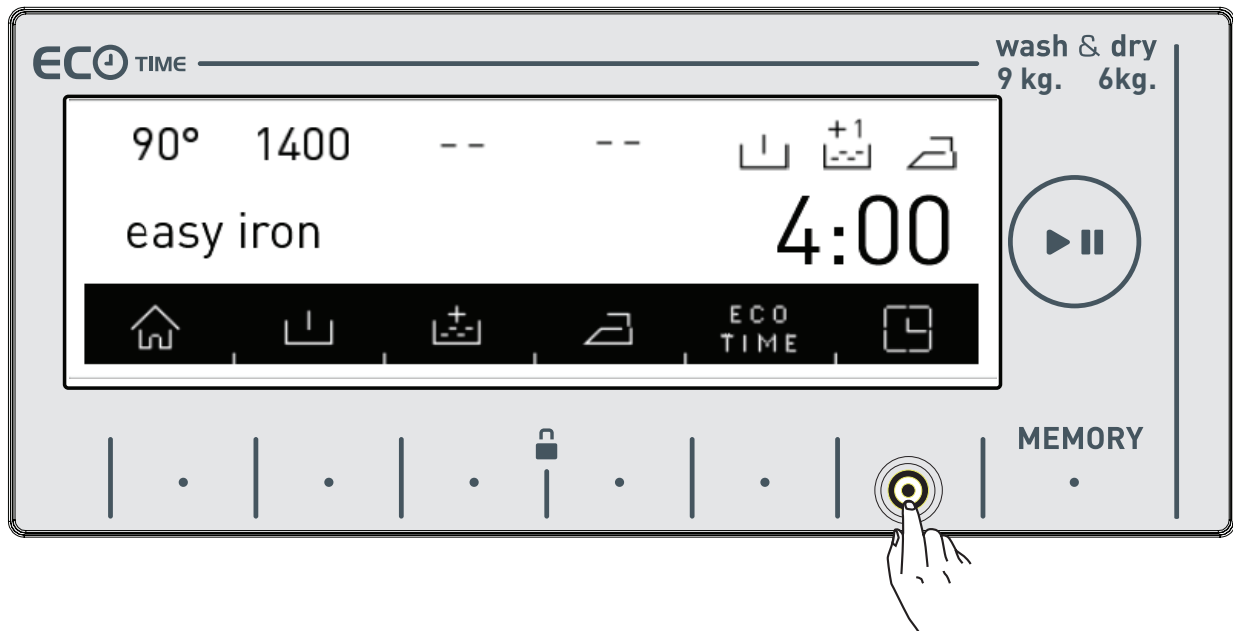

- The current time shall be displayed on the screen for a short duration.

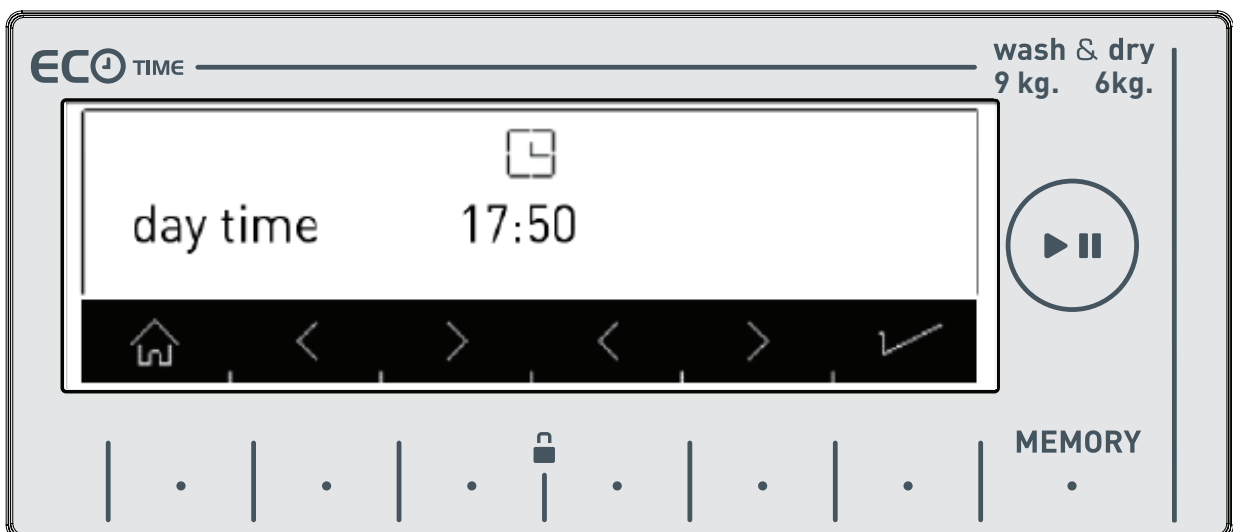



- The screen displaying the current time will automatically return to the screen that displays the delay time / finish time.
- On this screen, you can delay the washing time, or make the washing operation end at a time you wish by touching the < > symbol buttons.

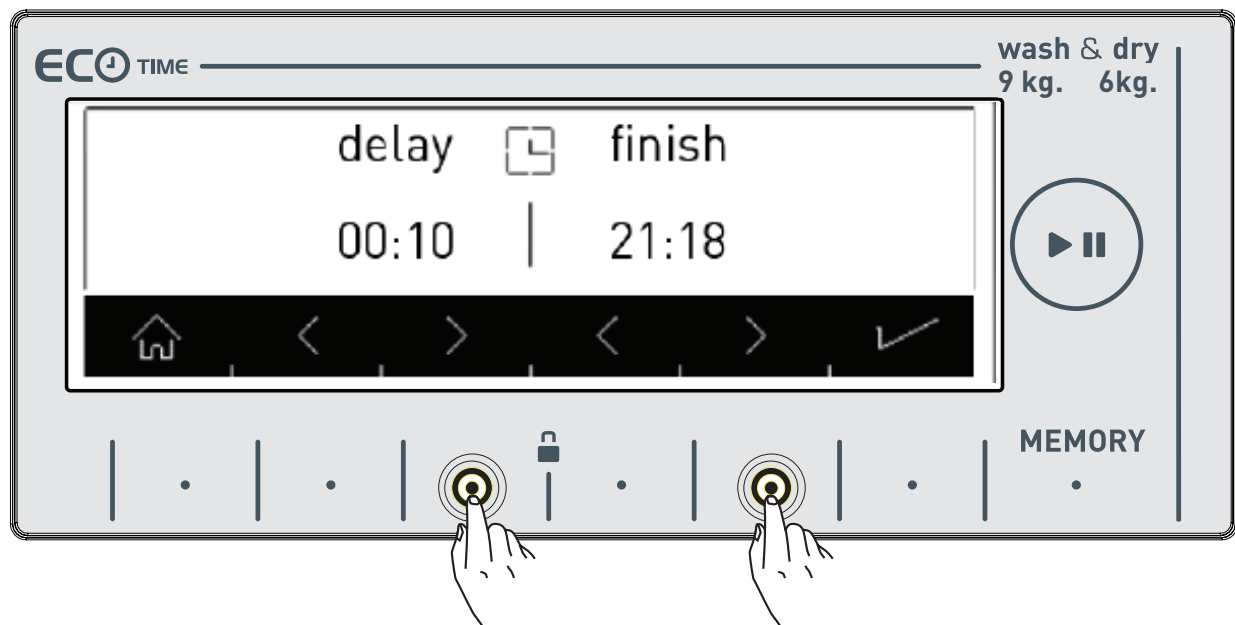

**Note:** The current time setting must be accurate to be able to use this function correctly. See page 38 to change the current time setting.

## Memory record function button (MEMORY)

With this feature of your machine, you can store the washing and drying programme you have used before or programme settings you have performed before by simply touching a button without taking your time with this memory option. Thus, you can wash and dry your laundry without performing these settings again. Select the settings you would like to store in the memory on the display and touch the favorite record button.

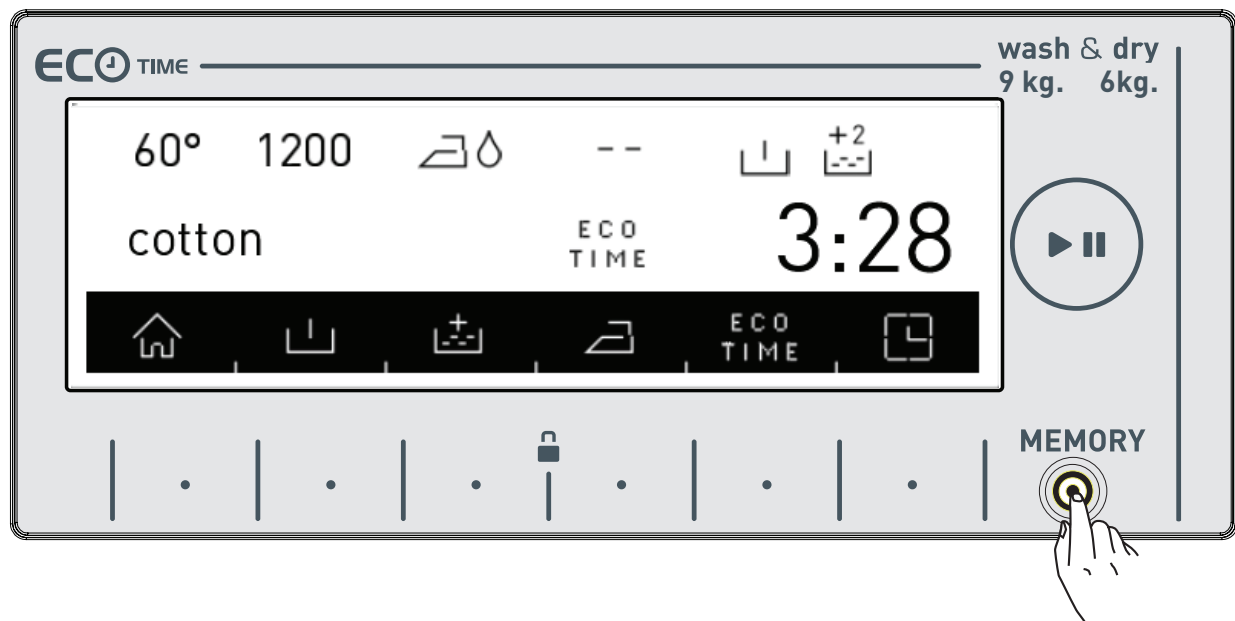

- If you would like to make changes on the washing and drying programme before storing, you can return to the programme menu by pressing **X** button.



You can touch the favorite button again when you have performed the change you desire.

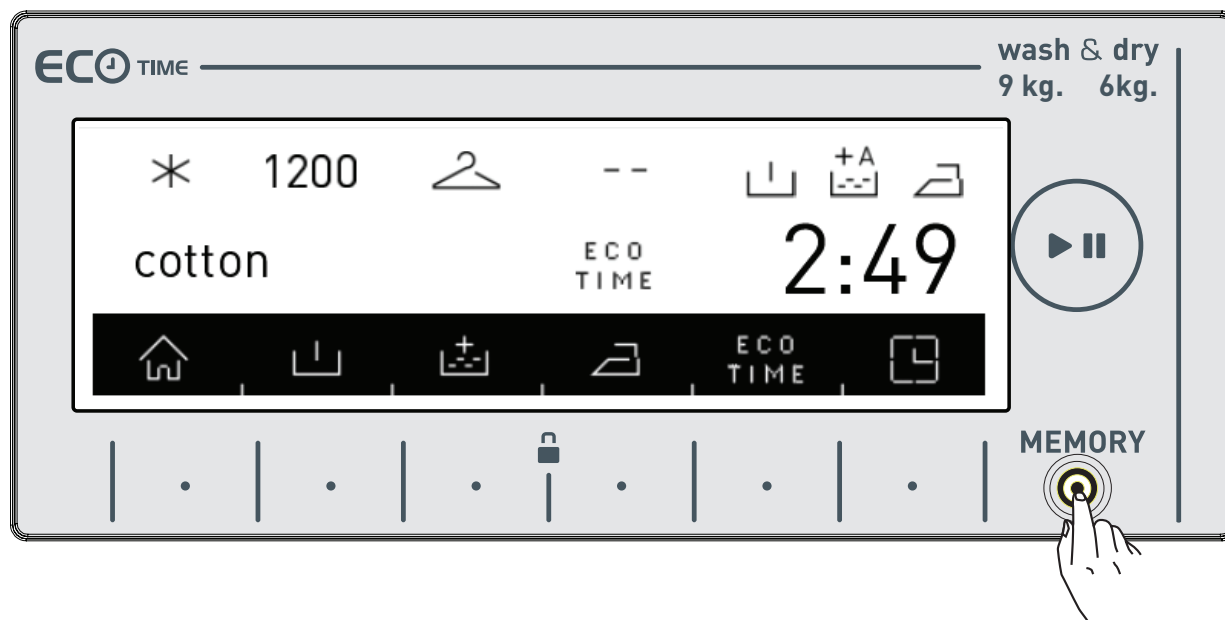

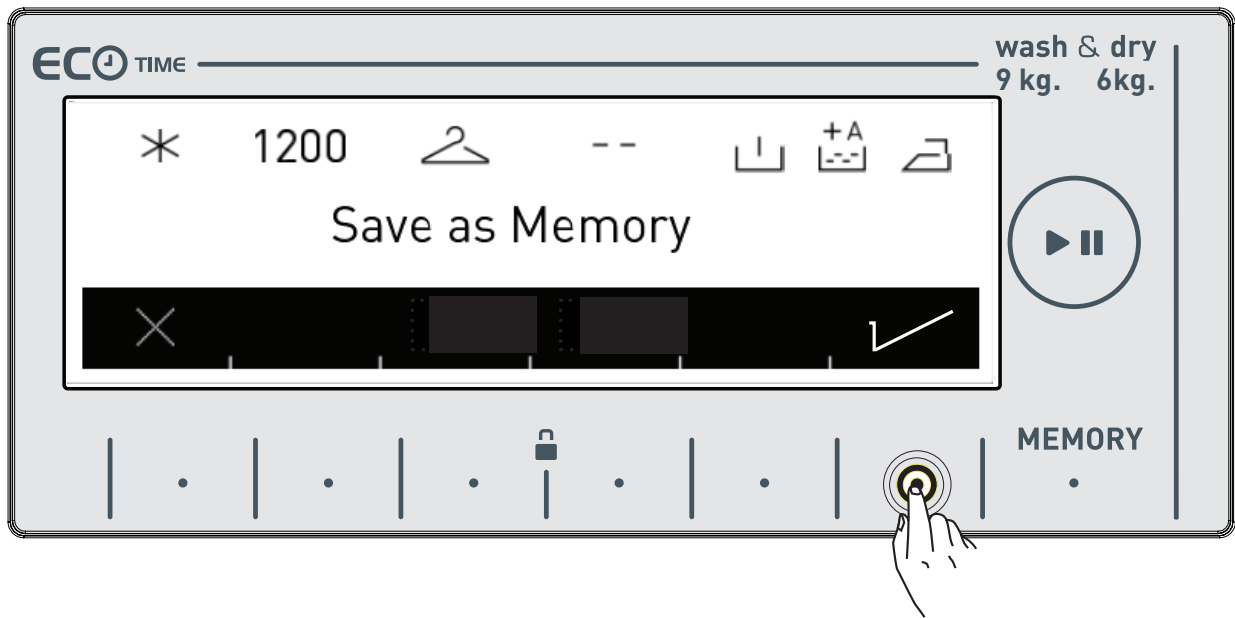

- You can store it by pressing ✓ symbol button.



- A screen as shown above shall be displayed when the storing is complete and your machine shall automatically return to the main screen of the washing or drying programme where you performed the setting operation.

- You can wash your laundry or select other programme by pressing start/hold button to perform washing.

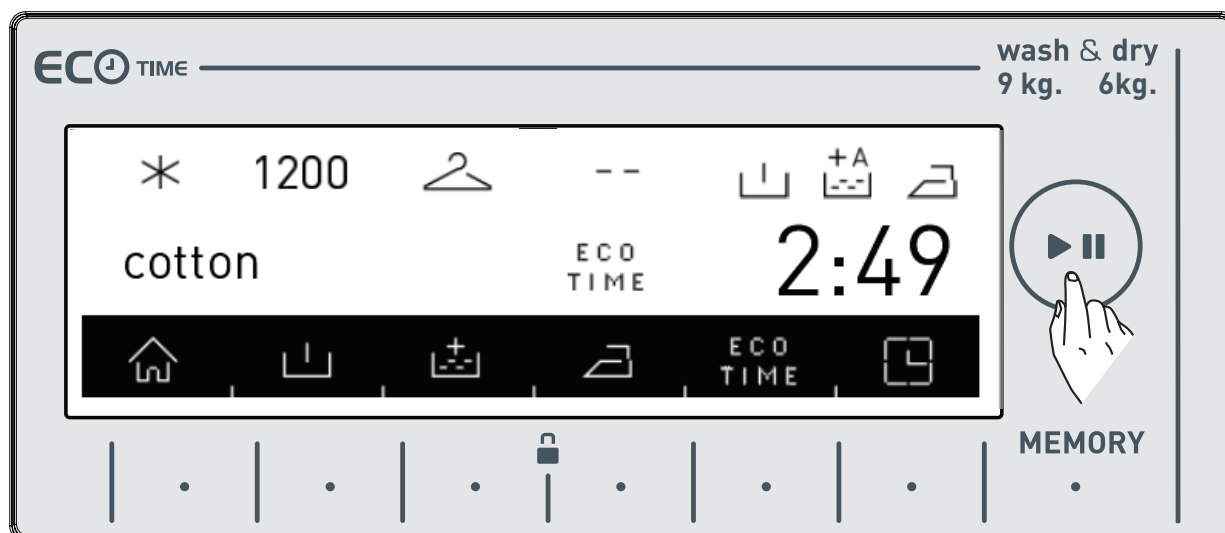

- If you would like to use the programme you have stored in the memory, you can rotate the programme selection button to memory step and perform your selection as shown in the figure below.

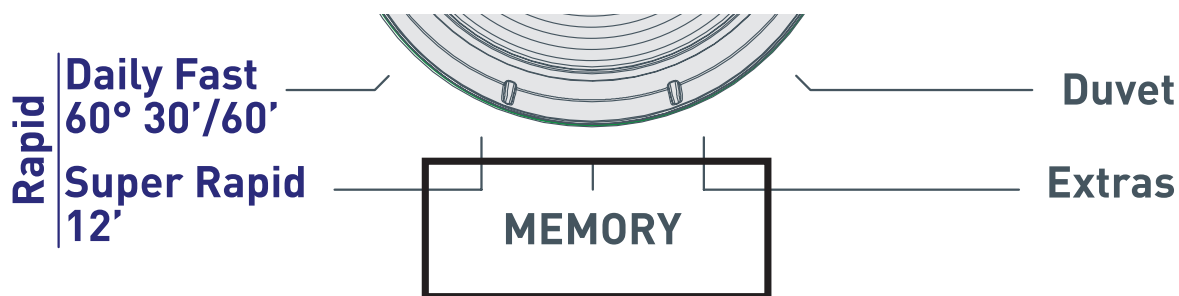

- If you would like to change the settings you have stored in the memory, select the memory option or perform the programme combination setting on any programme and touch the (MEMORY) button.

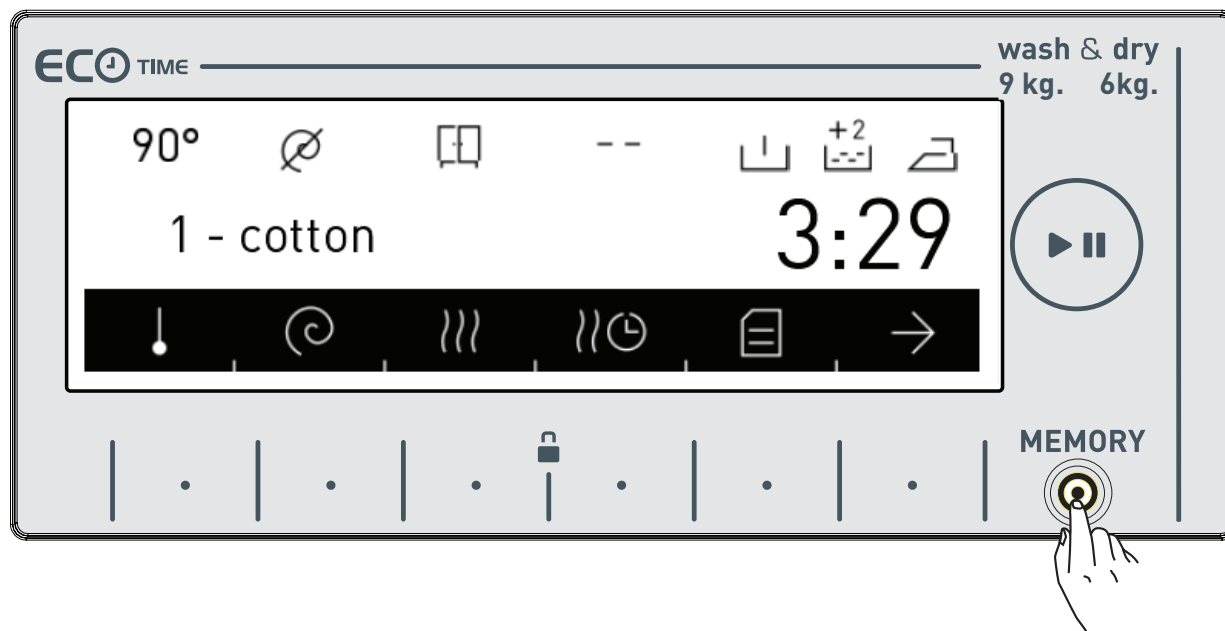

- If you would store a new programme on a previously stored programme, a confirmation dialog to confirm your selection shall be displayed on the screen, you can confirm your selection by pressing ✓ symbol button.

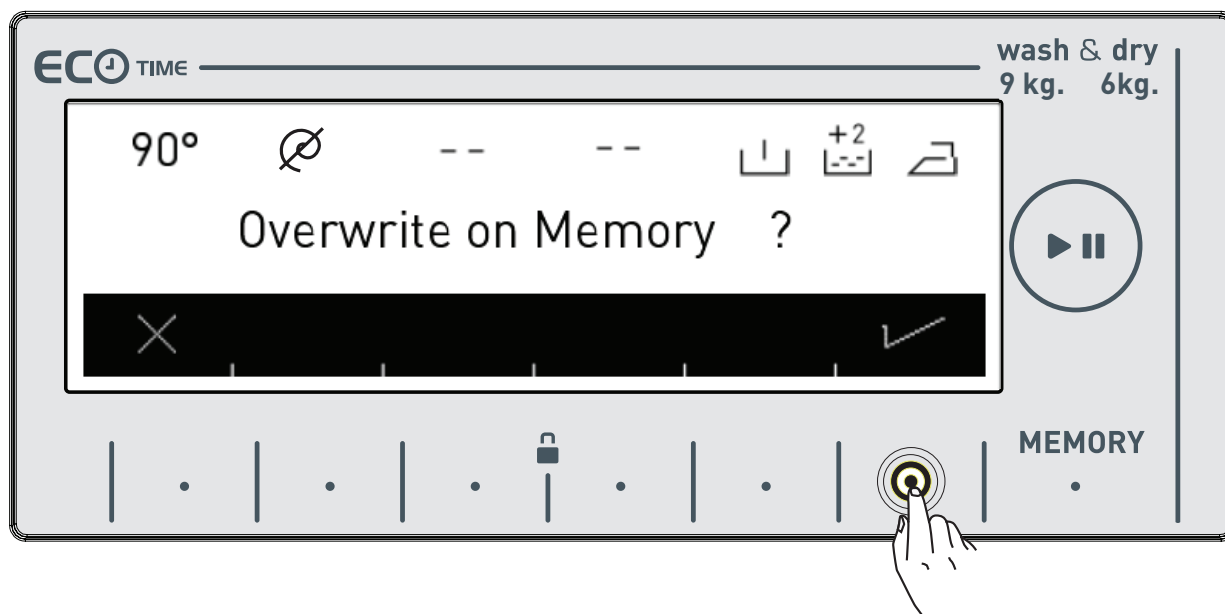

- This would allow you to store a new memory programme.





## Start/Pause button

### Starting the programme

- You can start the programme you have selected by touching the Start/Pause button
- When you turn your machine on, the programme you have selected will be active on the screen. The screens below are an example of what is displayed on screen during washing operations.



- Washing programme is ready.



- Washing programme is active.





• Washing step.

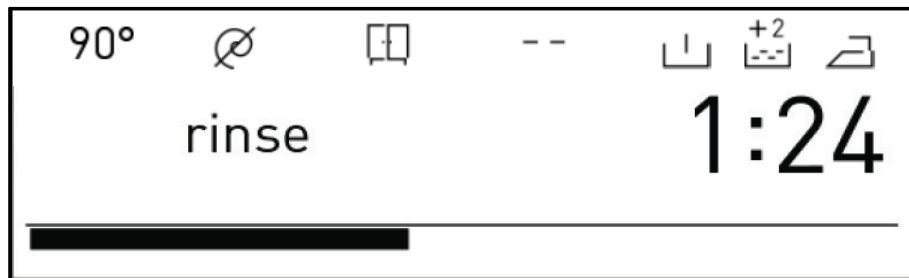

• Rinsing step.

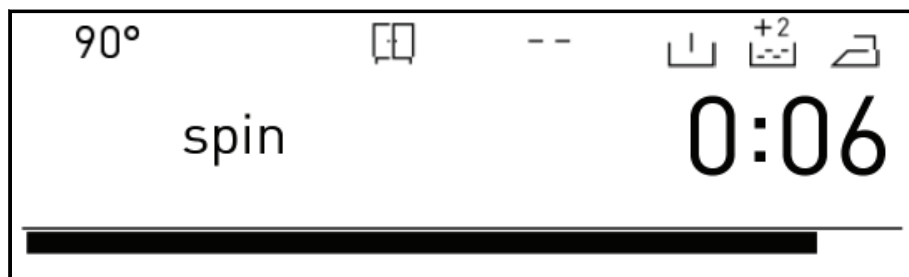

• Spinning step.



• Drying programme ready.

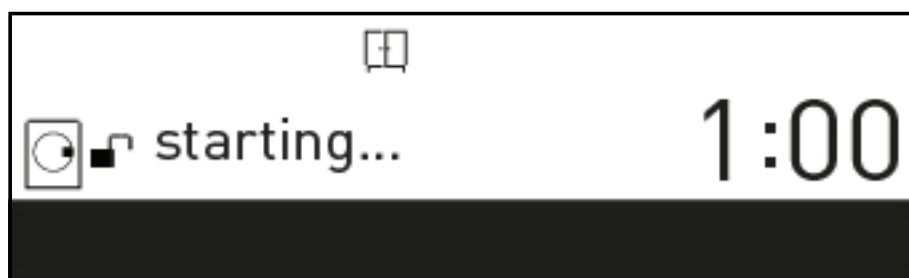

• Drying programme selected.



• Drying programme active.

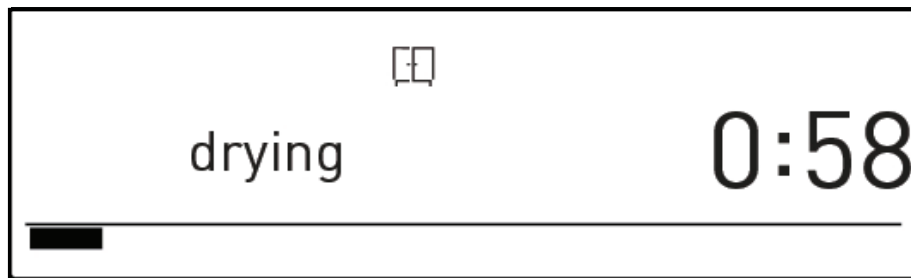

- Drying step.

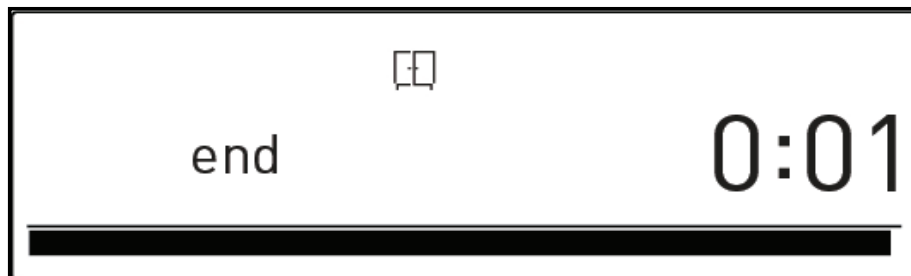

- Programme end.

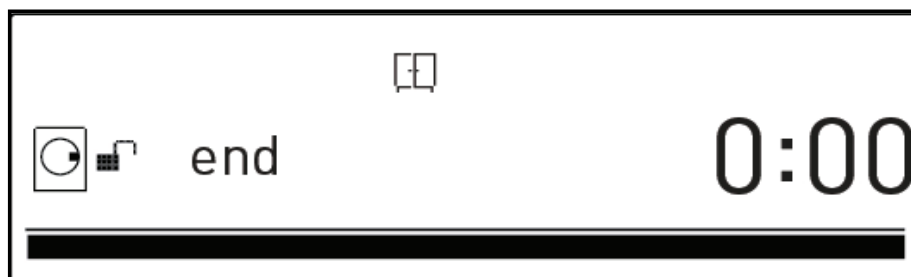



- Programme end door unlocked.

## Pausing a programme / Adding laundry

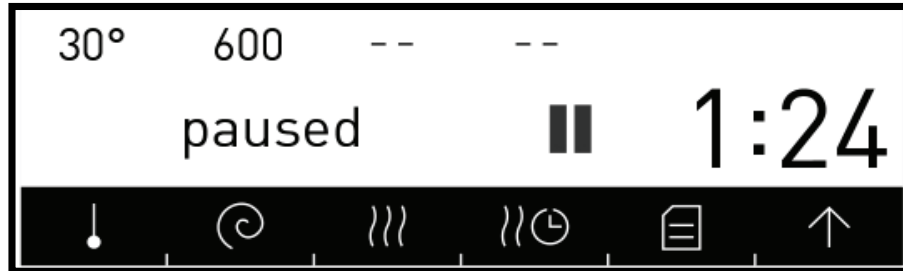
• You can pause or restart the programme you have selected with the  button. You can use this function when you want to add laundry to your machine.



• Washing stopped.

- If  symbol is displayed on the screen, you can open the door of your machine and add laundry.
- If  symbol is displayed on the screen you machine has passed the laundry adding step.

## Cancelling a programme

If you want to cancel a programme that is running:

- Switch the programme button to the the CANCEL position.
- Your machine will stop the washing operation and the programme will be cancelled.
- To get rid of the water accumulated in the machine switch the programme button to any programme.
- Your machine will perform the necessary discharge operation and cancel the programme.
- You can run your machine by selecting a new programme.

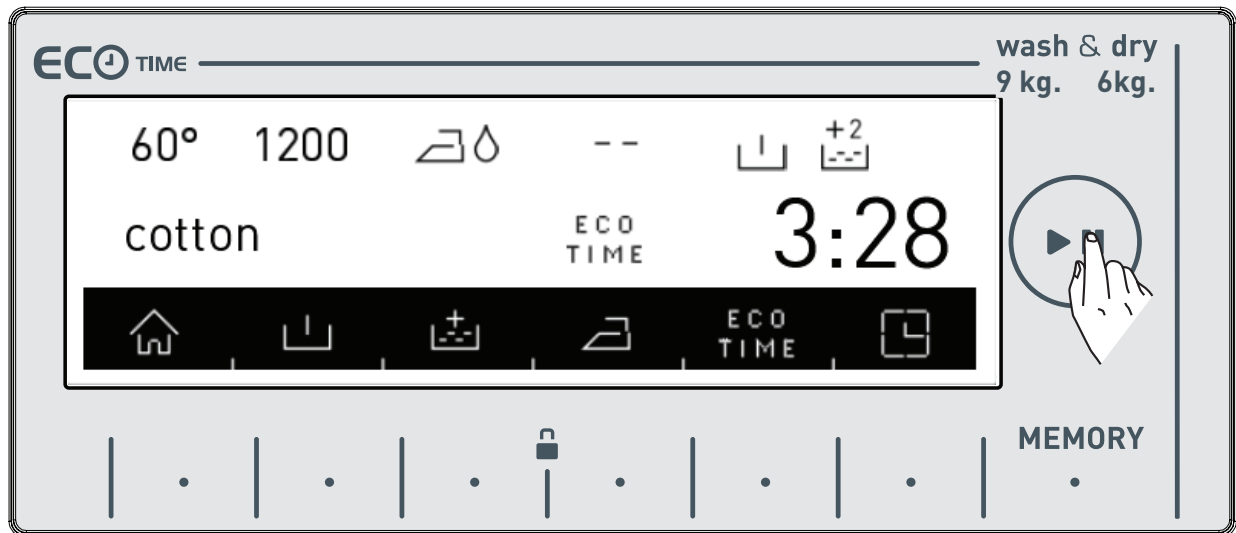

- See Page 78 for the Program Table

## Finishing a programme

Your machine will stop by itself as soon as the programme you have selected finishes.

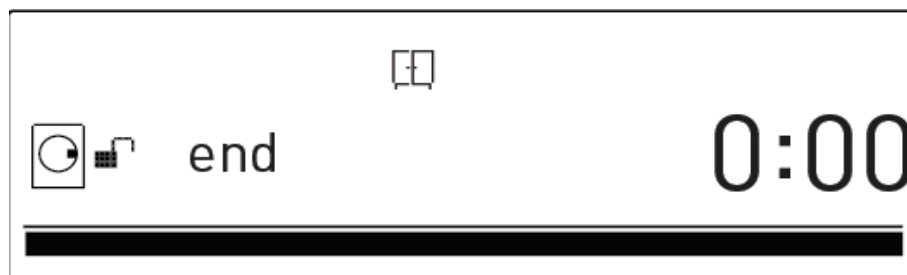

- "end" is displayed on the screen.

- You can open the machine's door and remove the laundry.
- Leave the door of your machine open after removing the laundry so that the machine can dry out.
- Switch the programme button to the CANCEL position.
- Unplug your machine.
- Turn the water faucet off.

**If you are not satisfied with the drying level of your laundry, select the best drying programme for your laundry and dry your laundry again.**

**Note:** Your machine has a cooling stage that cools down your laundry at the end of the drying operation. This cooling stage is designed to prevent users from being harmed as they remove the



## Child Lock

Your machine has a child lock so that the programme flow is not affected if the function buttons are pressed or the programme knob is turned while the machine is washing or drying.

Child lock engages after both of the  buttons next to the | . | . | symbol are pressed for more than 3 seconds.

The following warning text will be displayed after the child lock engages.

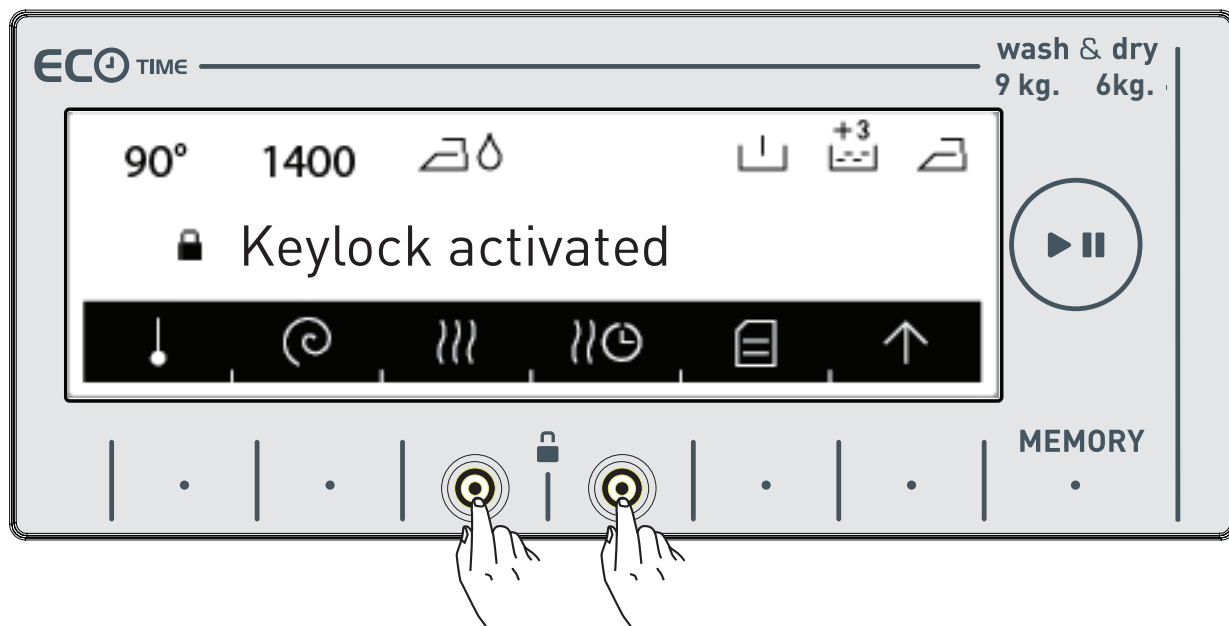

The following text will be displayed if any buttons are pressed while the child lock is engaged.

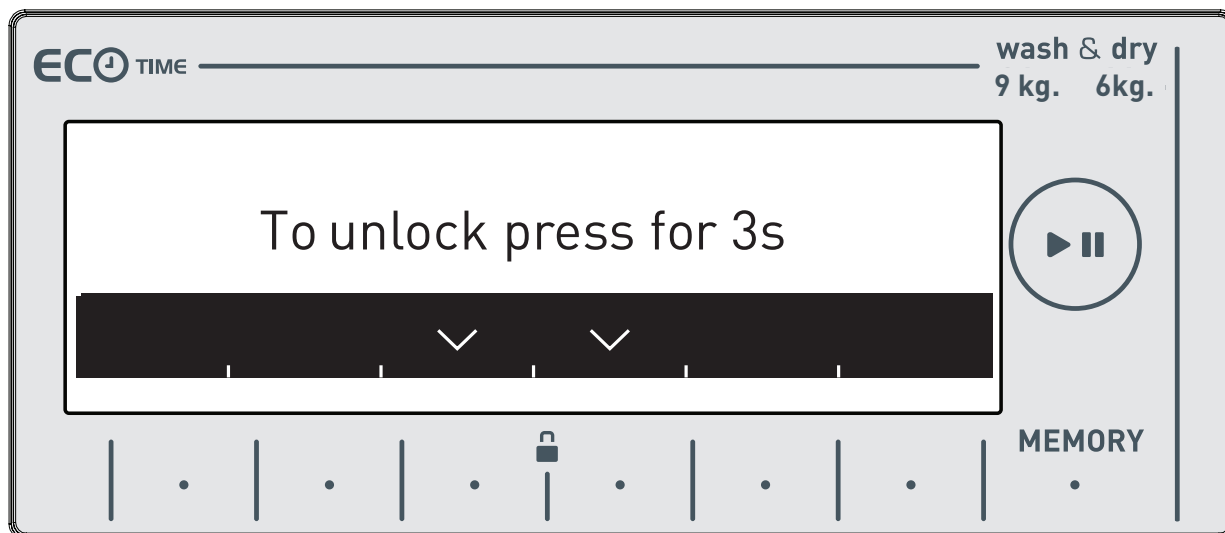

If the child lock is engaged while any programme is running and the programme knob is switched to the CANCEL position and another programme is selected, the programme previously selected continues from where it left. No change will occur.

To disengage the child lock, you need to press the | · | buttons for more than 3 seconds. The following warning text will be displayed after the child lock disengages.

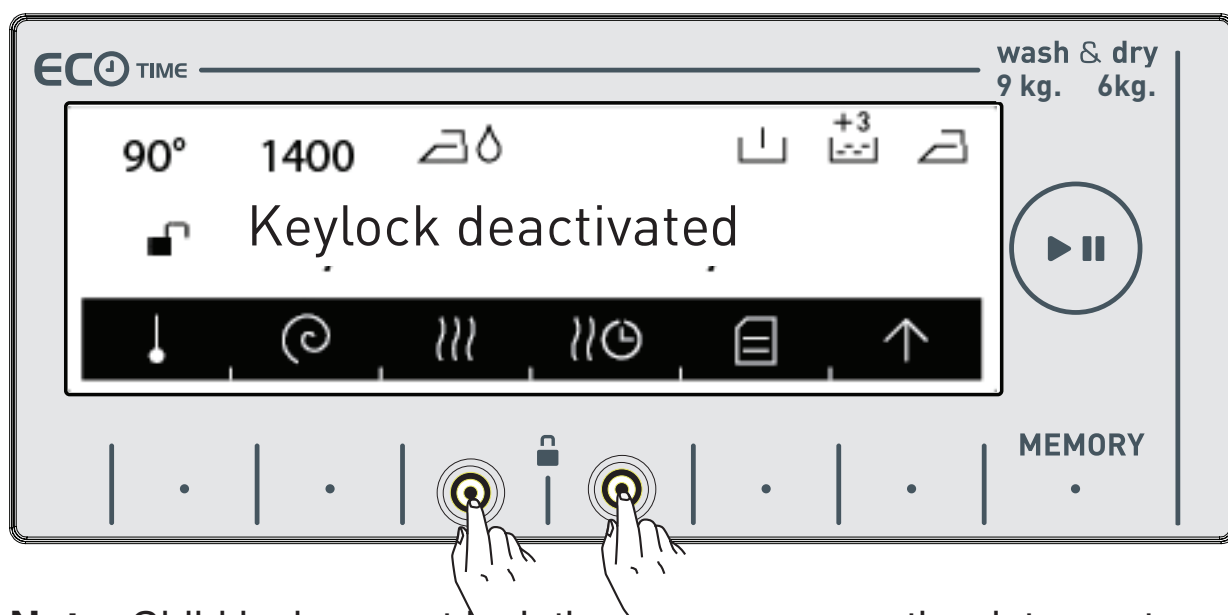

**Note:** Child lock cannot lock the pump cover or the detergent drawer of your machine.

## Program Table

### Cotton

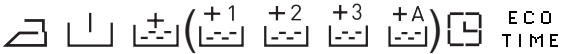
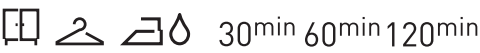
Selectable washing temperatures (°C)	* (Cold water), 30°, 40°, 60°, 90°*
Maximum washing/drying capacity (kg)	9,0 / 6,0
Selectable spin speed (rev / min)	∅ (No spin), 400, 600, 800, 1000, 1200, <b>1400*</b>
Laundry type / Descriptions	Heat resistant, cotton and linen textile.. (Underwear, bed sheet, tablecloth, towel (max. 4.0 kg))
Selectable additional functions **	
Selectable drying functions **	

### Cotton Eco

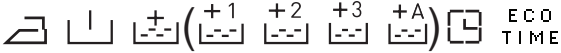
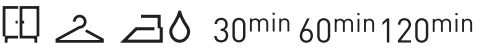
Selectable washing temperatures (°C)	* (Cold wash), 30°, 40°, 60°*
Maximum washing/drying capacity (kg)	9,0 / 6,0
Selectable spin speed (rev / min)	∅ (No spin), 400, 600, 800, 1000, 1200, <b>1400*</b>
Laundry type / Descriptions	Cotton and linen textiles (underwear, bed sheet, tablecloth, towel (max. 4.0 kg))
Selectable additional functions **	
Selectable drying functions **	

(\*) Programme factory default settings.

(\*\*) When you want to select more than one additional function, the additional functions you wish to select may not comply with each other.







Do not dry towels, cotton and linens, and synthetic and sythetic mix clothes together.

For drying select the most appropriate drying program for the clothes.

**NOTE: THE PROGRAM DURATION MIGHT CHANGE ACCORDING TO THE AMOUNT OF LAUNDRY, TAP WATER, AMBIENT TEMPERATURE AND SELECTED ADDITIONAL FUNCTIONS.**

## Program Table

### Eco 20°

Selectable washing temperatures (°C)	20°*
Maximum washing/drying capacity (kg)	4,0 / 4,0
Selectable spin speed (rev / min)	∅ (No spin), 400, 600, 800, 1000, 1200, 1400*
Laundry type / Descriptions	Less dirty, cotton and linen textiles. (bed sheet, tablecloth, towel (max. 2.0 kg))
Selectable additional functions **	  (+1 +2 +3)  ECO TIME
Selectable drying functions **	   30min 60min 120min

(\*) Programme factory default settings.

(\*\*) When you want to select more than one additional function, the additional functions you wish to select may not comply with each other.

Do not dry towels, cotton and linens, and synthetic and sythetic mix clothes together.

For drying select the most appropriate drying program for the clothes.

**NOTE: THE PROGRAM DURATION MIGHT CHANGE ACCORDING TO THE AMOUNT OF LAUNDRY, TAP WATER, AMBIENT TEMPERATURE AND SELECTED ADDITIONAL FUNCTIONS.**



# Program Table

## Synthetics

Synthetic\*\*\*

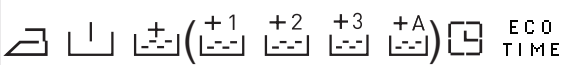
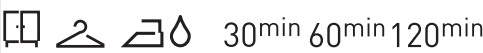
Selectable washing temperatures (°C)	* (Cold wash), 30°, 40°, <b>60°*</b>
Maximum washing/drying capacity (kg)	3,5 / 3,5
Selectable spin speed (rev / min)	∅ (No spin), 400, 600, <b>800*</b>
Laundry type / Descriptions	Synthetic and synthetic mix textiles. (synthetic content shirt, blouse, socks etc.)
Selectable additional functions **	
Selectable drying functions **	

Curtain\*\*\*

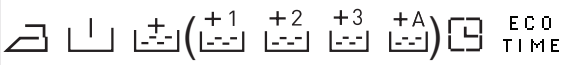
Selectable washing temperatures (°C)	* (Cold wash), 30°, <b>40°*</b>
Maximum washing/drying capacity (kg)	2,5
Selectable spin speed (rev / min)	∅ (No spin), 400, <b>600*</b>
Laundry type / Descriptions	Wash your <b>curtains</b> only with this programme.
Selectable additional functions **	
Selectable drying functions **	-

(\* ) Programme factory default settings.

(\*\* ) When you want to select more than one additional function, the additional functions you wish to select may not comply with each other.

(\*\*\* ) These are sub-programmes. Refer to page 90 for programme selection.

! Curtain is a program with a pre-wash programme. Do not forget to add detergent to the pre-wash compartment of the detergent drawer when you use this programme

Do not dry towels, cotton and linens, and sythetic and sythetic mix clothes together.

For drying select the most appropriate drying program for the clothes.

**NOTE: THE PROGRAM DURATION MIGHT CHANGE ACCORDING TO THE AMOUNT OF LAUNDRY, TAP WATER, AMBIENT TEMPERATURE AND SELECTED ADDITIONAL FUNCTIONS.**

# Program Table

## Delicates

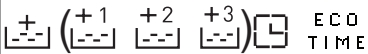
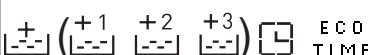
Wool ***	Selectable washing temperatures (°C)	* (Cold wash), 30°, 40°*
	Maximum washing capacity (kg)	2,5
	Selectable spin speed (rev / min)	∅ (No spin), 400, 600*
	Laundry type / Descriptions	Woollen and wool mix laundry with machine wash labels.
	Selectable additional functions **	
	Selectable drying functions **	-
Silk ***	Selectable washing temperatures (°C)	* (Cold wash), 30°*
	Maximum washing capacity (kg)	2,5
	Selectable spin speed (rev / min)	∅ (No spin), 400, 600*
	Laundry type / Descriptions	Silk mixture laundry with machine wash labels.
	Selectable additional functions **	
	Selectable drying functions **	-

(\* ) Programme factory default settings.

(\*\* ) When you want to select more than one additional function, the additional functions you wish to select may not comply with each other.

(\*\*\* ) These are sub-programmes. Refer to page 92 for programme selection.



Do not dry towels, cotton and linens, and synthetic and sythetic mix clothes together.

For drying select the most appropriate drying program for the clothes.

**NOTE: THE PROGRAM DURATION MIGHT CHANGE ACCORDING TO THE AMOUNT OF LAUNDRY, TAP WATER, AMBIENT TEMPERATURE AND SELECTED ADDITIONAL FUNCTIONS.**

## Program Table

### Duvet

Selectable washing temperatures (°C)	* (Cold wash), 30°, 40°*
Maximum washing capacity (kg)	2,5
Selectable spin speed (rev / min)	∅ (No spin), 400, 600, 800*
Laundry type / Descriptions	You can wash your fibre duvet that have machine washable label with this programme. (max. 2.5 kg)
Selectable additional functions **	 (+) (+1) (+2) (+3) (+A)  ECO TIME
Selectable drying functions **	-

(\*) Programme factory default settings.

(\*\*) When you want to select more than one additional function, the additional functions you wish to select may not comply with each other.

Do not dry towels, cotton and linens, and synthetic and sythetic mix clothes together.





For drying select the most appropriate drying program for the clothes.

**NOTE: THE PROGRAM DURATION MIGHT CHANGE ACCORDING TO THE AMOUNT OF LAUNDRY, TAP WATER, AMBIENT TEMPERATURE AND SELECTED ADDITIONAL FUNCTIONS.**





# Program Table

## Extras

### Cotton Dry \*\*\*

Selectable washing temperatures (°C)	-
Maximum drying capacity (kg)	6,0 kg
Selectable spin speed (rev / min)	-
Laundry type / Descriptions	Cotton laundry with machine dryable label.
Selectable additional functions **	 ECO TIME
Selectable drying functions **	 *    30 <sup>dk.</sup> 60 <sup>dk.</sup> 120 <sup>dk.</sup>

### Gentle Dry \*\*\*

Selectable washing temperatures (°C)	-
Maximum drying capacity (kg)	3,5
Selectable spin speed (rev / min)	-
Laundry type / Descriptions	Cotton laundry with machine dryable label.
Selectable additional functions **	 ECO TIME
Selectable drying functions **	 *    30 <sup>dk.</sup> 60 <sup>dk.</sup> 120 <sup>dk.</sup>

(\*) Programme factory default settings.

(\*\*) When you want to select more than one additional function, the additional functions you wish to select may not comply with each other.

(\*\*\*) These are sub-programmes. Refer to page 94 for programme selection.

Do not dry towels, cotton and linens, and synthetic and sythetic mix clothes together.

For drying select the most appropriate drying program for the clothes.

**NOTE: THE PROGRAM DURATION MIGHT CHANGE ACCORDING TO THE AMOUNT OF LAUNDRY, TAP WATER, AMBIENT TEMPERATURE AND SELECTED ADDITIONAL FUNCTIONS.**

# Program Table

## Extras

Rinse \*\*\*

Selectable washing temperatures (°C)	-
Maximum washing/drying capacity (kg)	9,0 / 6,0
Selectable spin speed (rev / min)	∅ (No spin), 400, 600, 800, 1000, 1200, <b>1400*</b>
Laundry type / Descriptions	If you want to additionally rinse your laundries upon completion of washing operation, you may use this programme for any kind of laundries.
Selectable additional functions **	( +1 +2 +3 +A ) ECO TIME
Selectable drying functions **	30min 60min 120min

Spin \*\*\*

Selectable washing temperatures (°C)	-
Maximum washing/drying capacity (kg)	9,0 / 6,0
Selectable spin speed (rev / min)	400, 600, 800, 1000, 1200, <b>1400*</b>
Laundry type / Descriptions	When you want to make an additional spinning to your laundry after the washing step, you can use this programme for all kinds of laundry.
Selectable additional functions **	ECO TIME
Selectable drying functions **	30min 60min 120min

(\*) Programme factory default settings.

(\*\*) When you want to select more than one additional function, the additional functions you wish to select may not comply with each other.

(\*\*\*) These are sub-programmes. Refer to page 94 for programme selection.

Do not dry towels, cotton and linens, and synthetic and sythetic mix clothes together.

For drying select the most appropriate drying program for the clothes.

**NOTE: THE PROGRAM DURATION MIGHT CHANGE ACCORDING TO THE AMOUNT OF LAUNDRY, TAP WATER, AMBIENT TEMPERATURE AND SELECTED ADDITIONAL FUNCTIONS.**

## Program Table

### Extras

Drain ***	Selectable washing temperatures (°C)	-
	Maximum washing/drying capacity (kg)	-
	Selectable spin speed (rev / min)	-
	Laundry type / Descriptions	<i>It makes the water inside the machine to be draining.</i>
	Selectable additional functions **	ECO TIME
	Selectable drying functions **	-
Drum clean ***	Selectable washing temperatures (°C)	-
	Maximum washing/drying capacity (kg)	-
	Selectable spin speed (rev / min)	-
	Laundry type / Descriptions	<i>It is washing drum cleaning programme. It must be used without laundry.</i>
	Selectable additional functions **	ECO TIME
	Selectable drying functions **	-

(\*) Programme factory default settings.

(\*\*) When you want to select more than one additional function, the additional functions you wish to select may not comply with each other.

(\*\*\*) These are sub-programmes. Refer to page 94 for programme selection.





Do not dry towels, cotton and linens, and synthetic and sythetic mix clothes together.

For drying select the most appropriate drying program for the clothes.





**NOTE: THE PROGRAM DURATION MIGHT CHANGE ACCORDING TO THE AMOUNT OF LAUNDRY, TAP WATER, AMBIENT TEMPERATURE AND SELECTED ADDITIONAL FUNCTIONS.**

## Program Table

### Super rapid 12 min

Selectable washing temperatures (°C)	* (Cold wash), <b>30°*</b>
Maximum washing/drying capacity (kg)	2,0 / 2,0
Selectable spin speed (rev / min)	∅ (No spin), 400, 600, <b>800*</b>
Laundry type / Descriptions	You can wash your less dirty, cotton, coloured and linen textiles in a short time as 12 minutes. <b>Note:</b> As the washing period is short, less amount of detergent is required to be used compared to other programmes. The programme period will increase if your machine detects instable loading.
Selectable additional functions **	  ECO TIME
Selectable drying functions **	   30min 60min 120min

### Daily Fast 60° 60 min.

Selectable washing temperatures (°C)	* (Cold wash), 30°, 40°, <b>60°*</b>
Maximum washing/drying capacity (kg)	4,0 / 4,0
Selectable spin speed (rev / min)	∅ (No spin), 400, 600, 800, 1000, 1200 <b>1400*</b>
Laundry type / Descriptions	Dirty, cotton, coloured and linen textiles. (The washing duration for loads of 2kg and under is 30 minutes)
Selectable additional functions **	  ECO TIME
Selectable drying functions **	   30min 60min 120min

(\*) Programme factory default settings.

(\*\*) When you want to select more than one additional function, the additional functions you wish to select may not comply with each other.

Do not dry towels, cotton and linens, and synthetic and sythetic mix clothes together.

For drying select the most appropriate drying program for the clothes.

**NOTE: THE PROGRAM DURATION MIGHT CHANGE ACCORDING TO THE AMOUNT OF LAUNDRY, TAP WATER, AMBIENT TEMPERATURE AND SELECTED ADDITIONAL FUNCTIONS.**

## Program Table

### Refresh

Selectable washing temperatures (°C)	-
Maximum laundry capacity (kg)	1,0
Selectable spin speed (rev / min)	-
Laundry type / Descriptions	Laundry that is not dirty and has odours on. <b>Note:</b> This programme is not a washing programme. It only breathes hot air onto your laundry and refreshes them.
Selectable additional functions **	 ECO TIME
Selectable drying functions **	-

(\*) Programme factory default settings.

(\*\*) When you want to select more than one additional function, the additional functions you wish to select may not comply with each other.

Do not dry towels, cotton and linens, and synthetic and sythetic mix clothes together.



For drying select the most appropriate drying program for the clothes.

**NOTE: THE PROGRAM DURATION MIGHT CHANGE ACCORDING TO THE AMOUNT OF LAUNDRY, TAP WATER, AMBIENT TEMPERATURE AND SELECTED ADDITIONAL FUNCTIONS.**





## Program Table

### Quick Wash & Dry 29 min.

Selectable washing temperatures (°C)	* (Cold wash), 30°**
Maximum washing/drying capacity (kg)	0,5 kg (3 shirts) (29 minutes) 1.5 kg (9 shirts) (60 minutes)
Selectable spin speed (rev / min)	800*
Laundry type / Descriptions	Cotton, coloured and linen laundry with machine dryable label. <b>Note:</b> It determines the duration of the programme itself according to the amount of laundry you will load into the machine.
Selectable additional functions **	 ECO TIME
Selectable drying functions **	 *

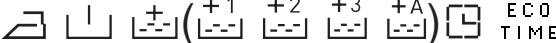
### Synthetics Wash & Dry

Selectable washing temperatures (°C)	* (Cold wash), 30°, 40°, 60°*
Maximum drying capacity (kg)	3,5
Selectable spin speed (rev / min)	800*
Laundry type / Descriptions	Synthetic and synthetic mix textiles. (synthetic content shirt, blouse, socks etc.)
Selectable additional functions **	  ECO TIME
Selectable drying functions **	 30 <sup>min</sup> 60 <sup>min</sup> 120 <sup>min</sup>

(\*) Programme factory default settings.

(\*\*) When you want to select more than one additional function, the additional functions you wish to select may not comply with each other.



Do not dry towels, cotton and linens, and synthetic and sythetic mix clothes together.

For drying select the most appropriate drying program for the clothes.

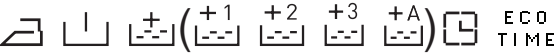

**NOTE: THE PROGRAM DURATION MIGHT CHANGE ACCORDING TO THE AMOUNT OF LAUNDRY, TAP WATER, AMBIENT TEMPERATURE AND SELECTED ADDITIONAL FUNCTIONS.**

## Program Table

### Cotton 60 Wash & Dry

Selectable washing temperatures (°C)	* (Cold wash), 30°, 40°, 60°*
Maximum washing/drying capacity (kg)	6,0
Selectable spin speed (rev / min)	1400*
Laundry type / Descriptions	Cotton and linen textiles (underwear, bed sheet, tablecloth, towel (max. 4.0 kg)
Selectable additional functions **	
Selectable drying functions **	

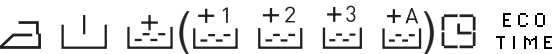
### Cotton 90 Wash & Dry

Selectable washing temperatures (°C)	* (Cold water), 30°, 40°, 60°, 90°*
Maximum washing/drying capacity (kg)	6,0
Selectable spin speed (rev / min)	1400*
Laundry type / Descriptions	Heat resistant, cotton and linen textile.. (Underwear, bed sheet, tablecloth, towel (max. 4.0 kg)
Selectable additional functions **	
Selectable drying functions **	

(\*) Programme factory default settings.

(\*\*) When you want to select more than one additional function, the additional functions you wish to select may not comply with each other.

Do not dry towels, cotton and linens, and synthetic and synthetic mix clothes together.

For drying select the most appropriate drying program for the clothes.

**NOTE: THE PROGRAM DURATION MIGHT CHANGE ACCORDING TO THE AMOUNT OF LAUNDRY, TAP WATER, AMBIENT TEMPERATURE AND SELECTED ADDITIONAL FUNCTIONS.**

## Selecting sub-programmes (Synthetics)

When you select the Synthetics programme from the programme knob, you will see two sub-program options.

1-Synthetics

2-Curtain

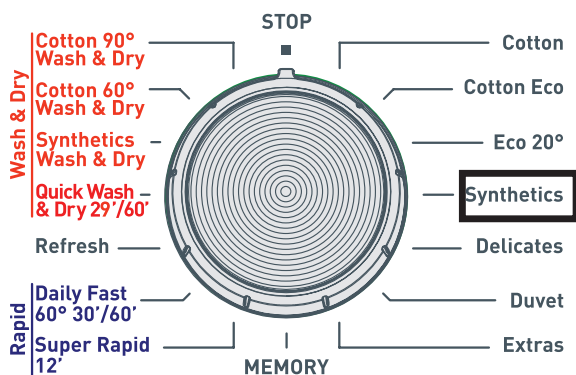

• You can make sub-programme < > selections by touching the symbol buttons.

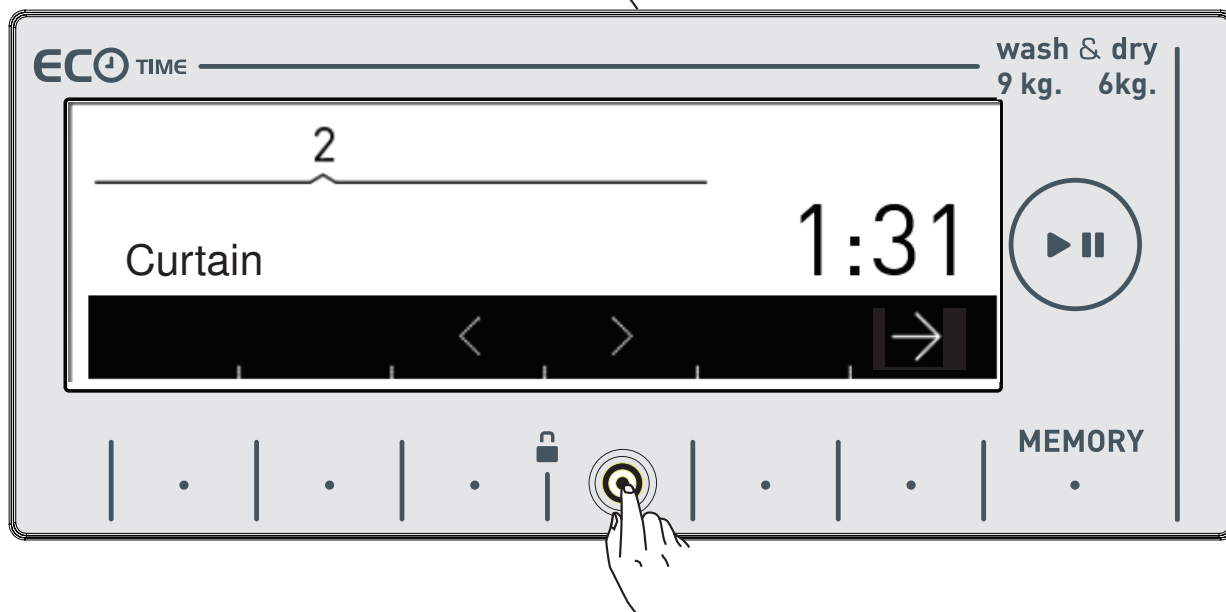
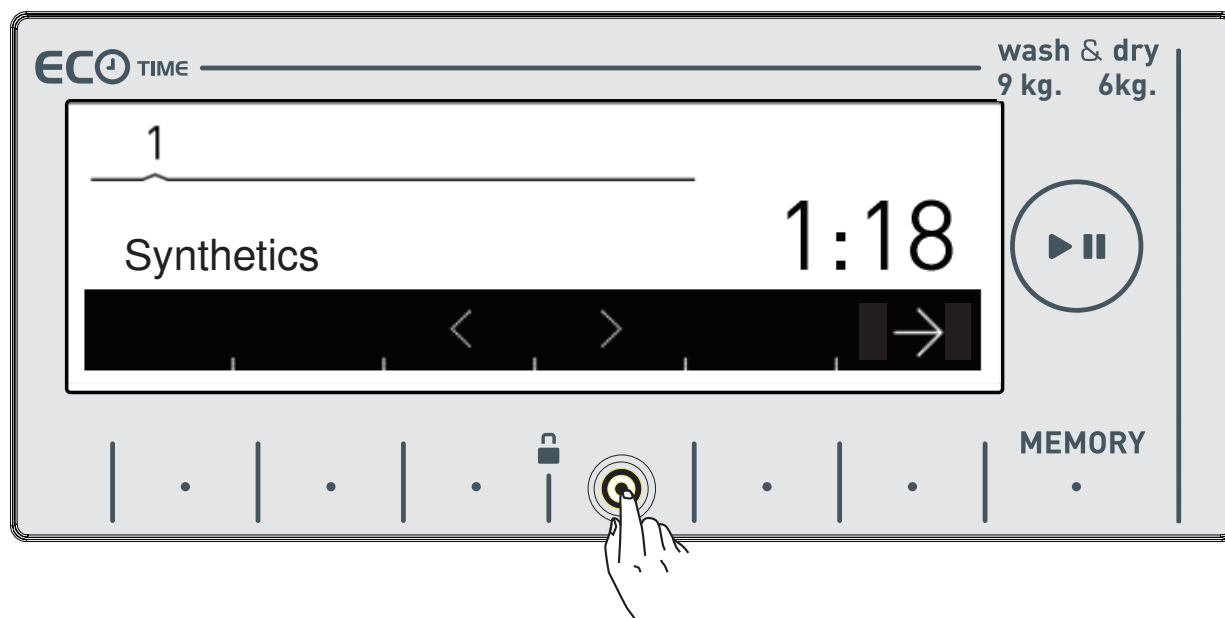

- You can activate the programme you want to select by touching the → symbol button.

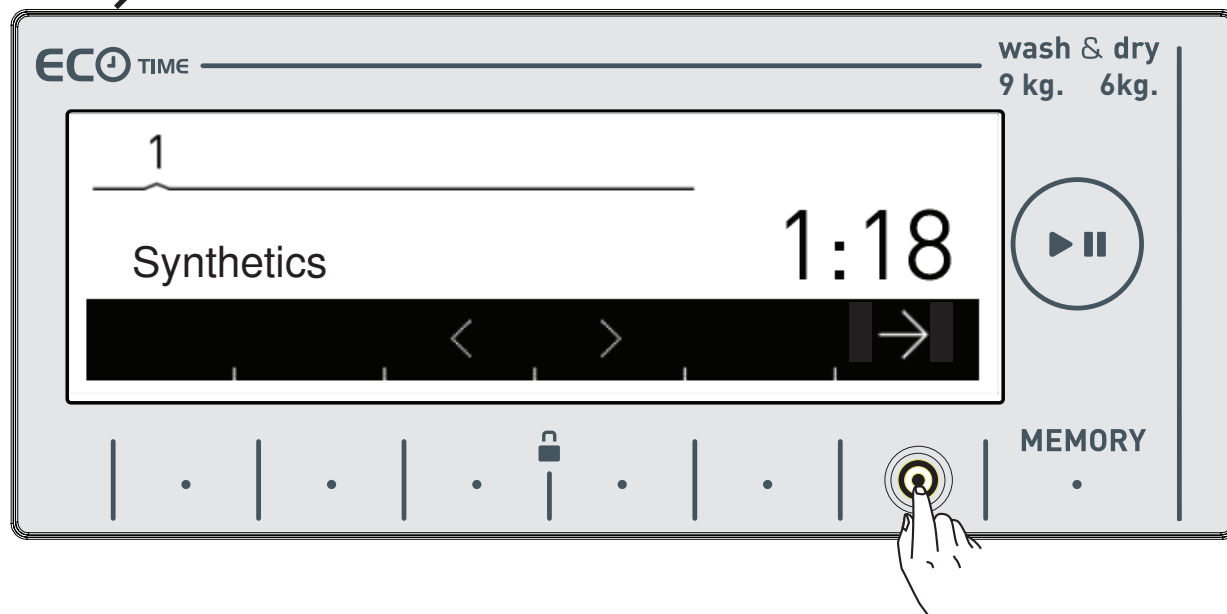

- After the the selection has been activated, the electronic display will return to the main screen of the programme you have selected automatically. You can select other features you want to select on this screen and run the machine by pressing the Start/ Pause button.

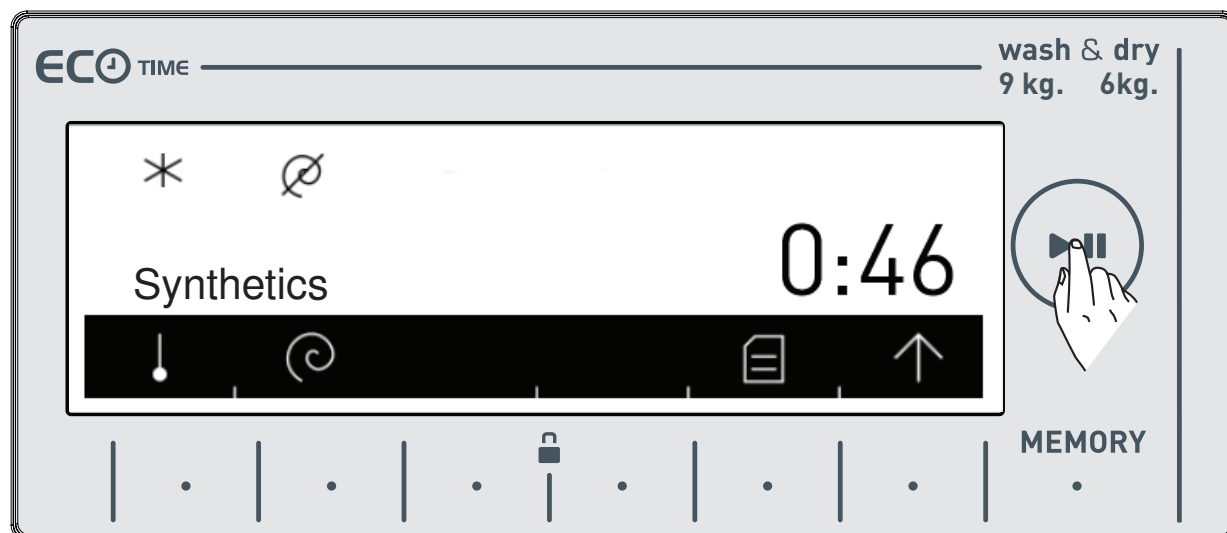

# Selecting sub-programmes (Delicates)

When you select the delicates programme from the programme knob, you will see two sub-program options.

- 1- Wool
- 2-Silk

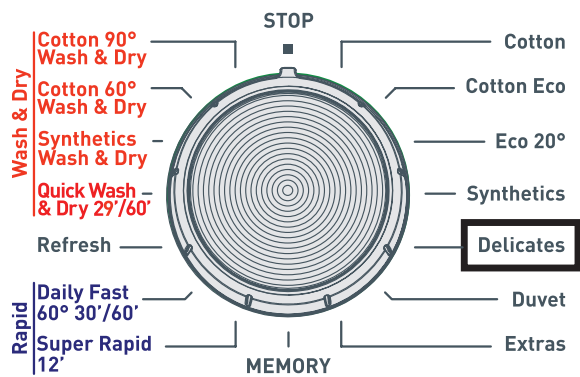

- You can make sub-programme < > selections by touching the symbol buttons.

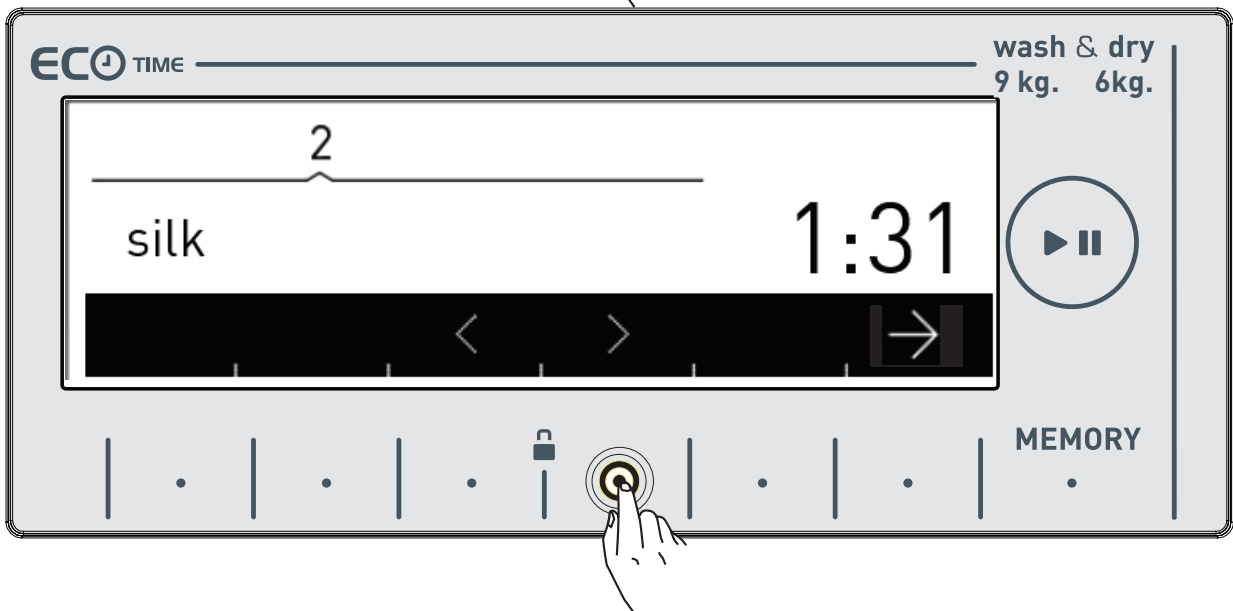
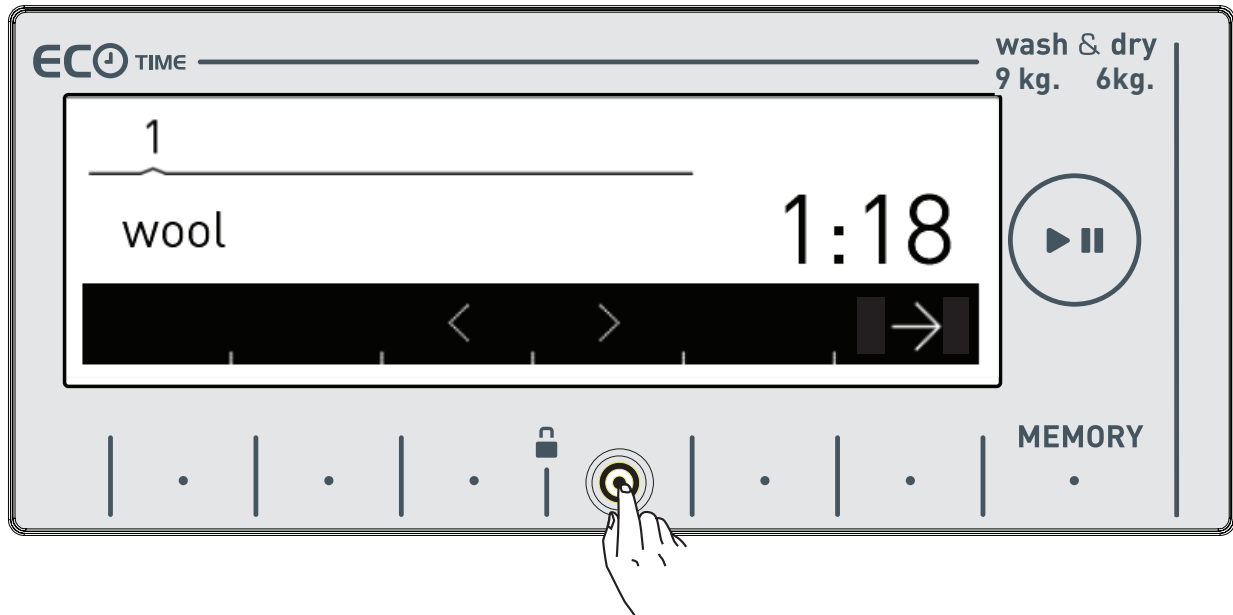

- You can activate the programme you want to select by touching the → symbol button.

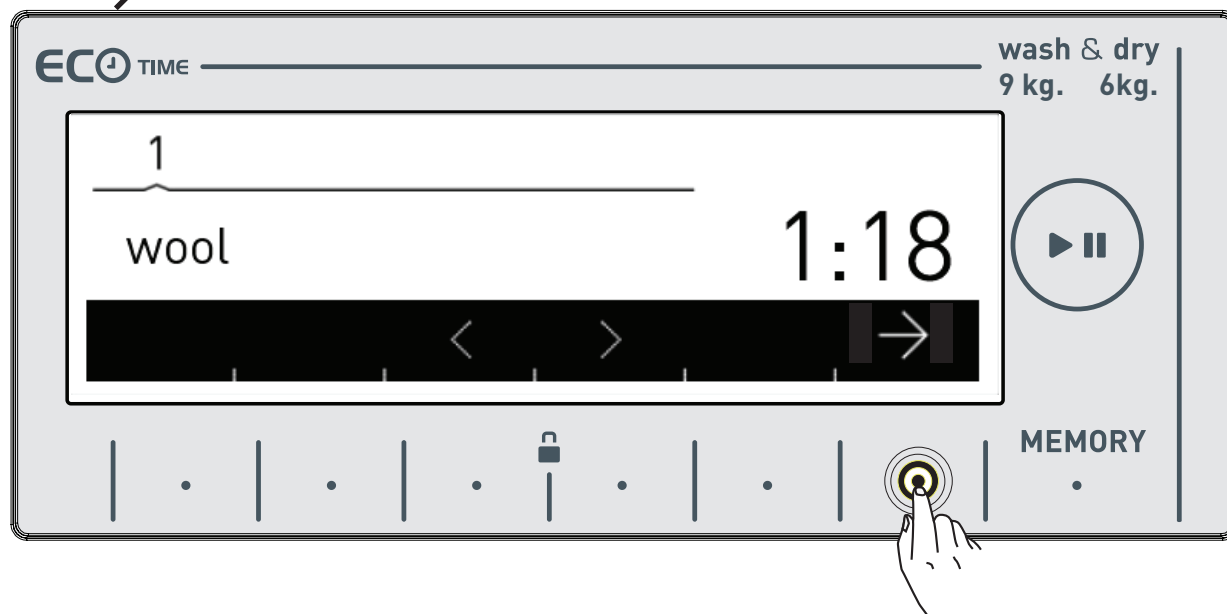

- After the the selection has been activated, the electronic display will return to the main screen of the programme you have selected automatically. You can select other features you want to select on this screen and run the machine by pressing the Start/ Pause button.

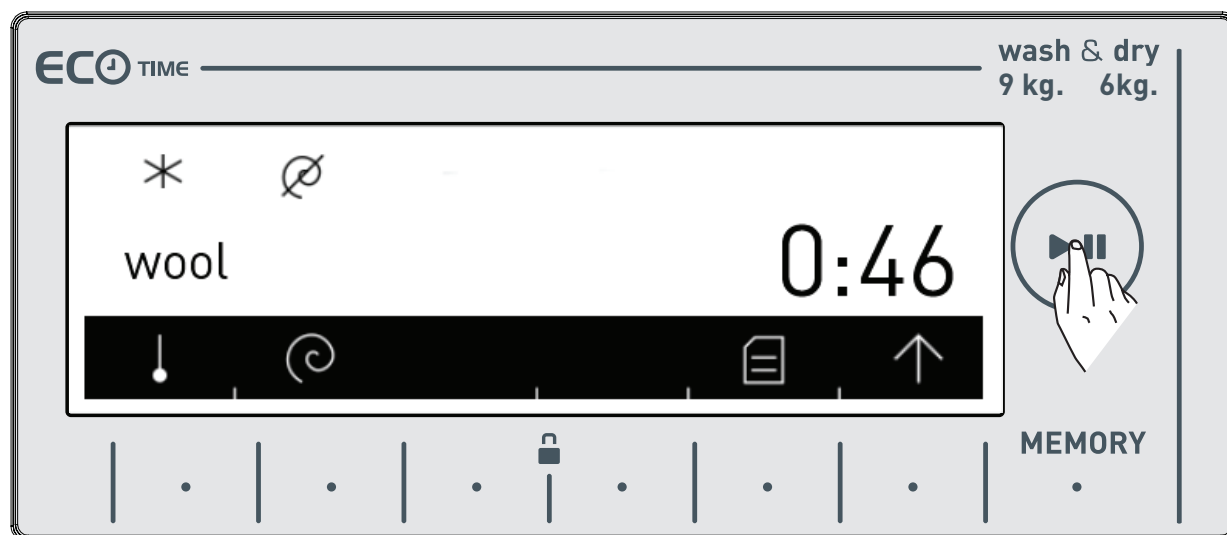

## Selecting sub-programmes (Extras)

When you select the **extras** programme from the programme knob, you will see 6 sub-program options.

- 1- Cotton Dry
- 2- Gentle Dry
- 3- Rinse
- 4- Spin
- 5- Drain
- 6- Drum clean

- You can make the sub-programme selections by touching the < > symbol buttons.

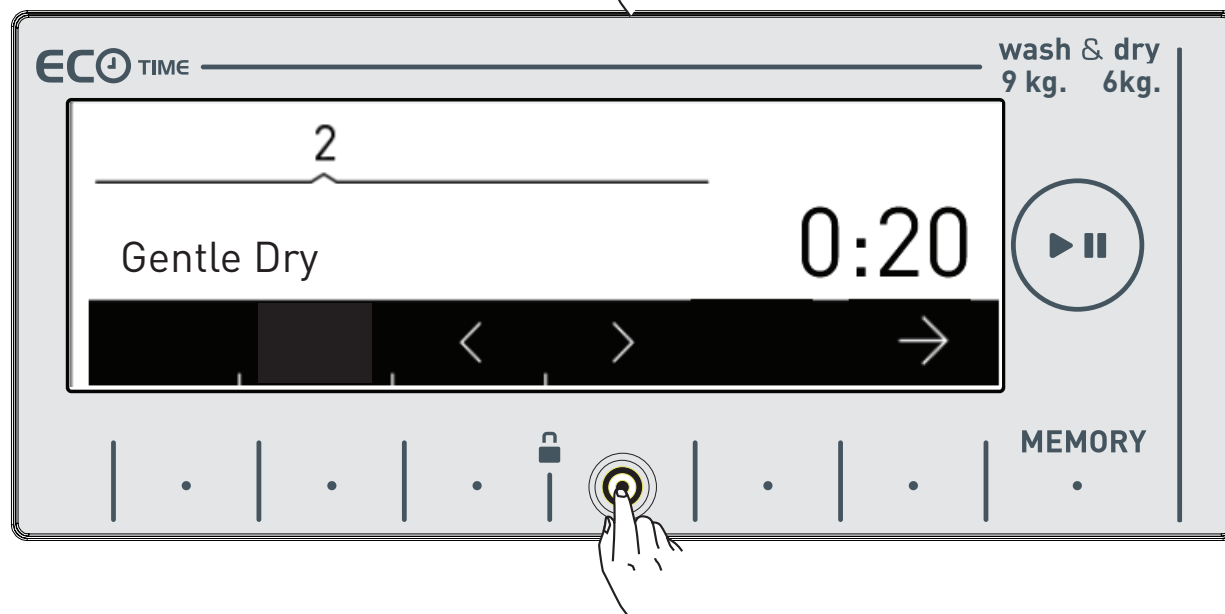
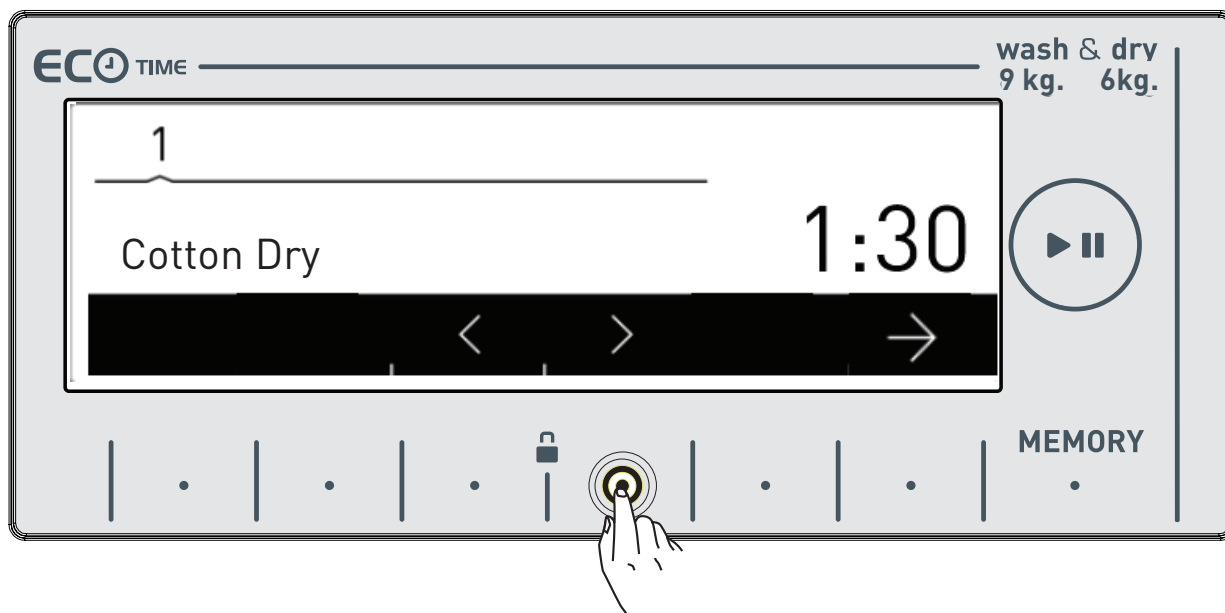
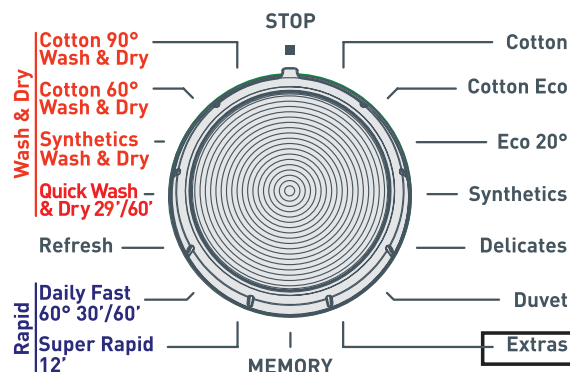

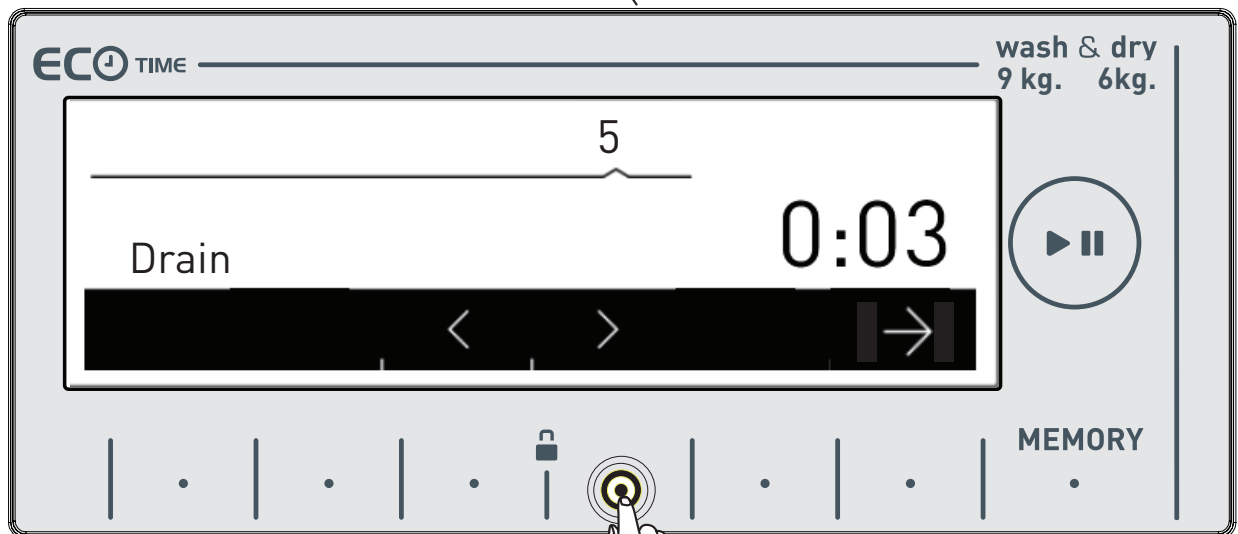





- You can activate the programme you want to select by touching the → symbol button.
- After the the selection has been activated, the electronic display will return to the main screen of the programme you have selected automatically. You can select other features you want to select on this screen and run the machine by pressing the Start/ Pause button.

# MAINTENANCE AND CLEANING OF YOUR MACHINE



## Notice !

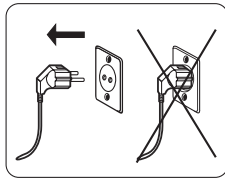

Unplug your machine before starting the maintenance and cleaning of your machine.

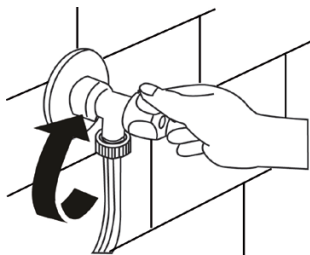

Turn off the water inlet before starting the maintenance and cleaning of your machine.



## Notice !

Your machine's parts might be damaged if cleaners with solvent agents are used. Do not use cleaning materials with solvent agents.

## Water inlet filters

Filters are in place to prevent foreign substances entering the machine and can be found both on the faucet side of the inlet hose and on the ends of water valves along the water inlet hose of your machine. If your machine cannot intake a sufficient amount of water despite the water faucet being open, these filters should be cleaned.

- Disconnect the ends of the water inlet hose from the tap and the machine.

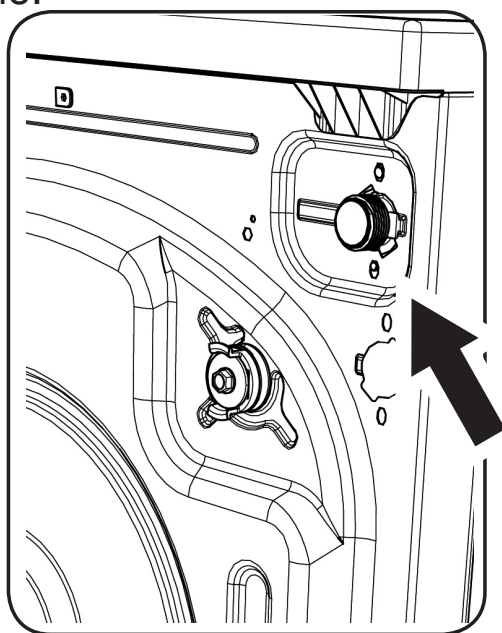

- Remove the filter of the water inlet valve on your machine with a pair of pliers. Clean thoroughly using water and a brush.

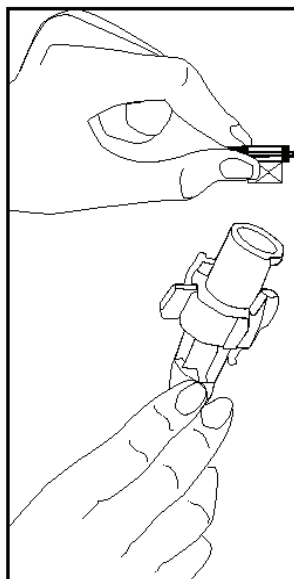

- Disassemble the filter on the faucet side of the water inlet hose manually and clean it.
- Once the filters are cleaned, put them correctly back in place.

## Detergent drawer maintenance and cleaning

- Your detergents may form residue in the detergent drawer and detergent drawer slot. Remove the detergent drawer in regular intervals to clean the formed residue. In order to remove the detergent drawer from its place:

- \* Pull the detergent drawing all the way back.

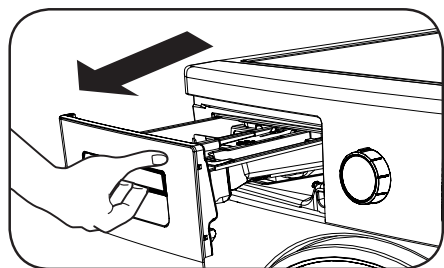

- Press the region shown below inside the detergent drawer you have pulled all the way back, and continue pulling and remove the detergent drawer from its place.

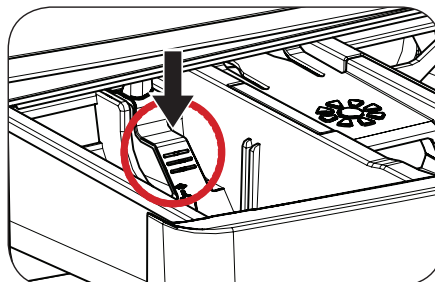
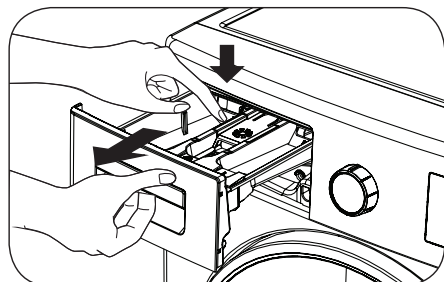

- Rinse with a brush and lots of water.
- Collect the residues inside the detergent drawer slot so that they don't fall inside your machine.
- Dry the detergent drawer with a towel or dry cloth and place it back.

- **Do not wash your detergent drawer in a dishwasher.**

### Liquid detergent apparatus(\*)

For the cleaning and maintenance of the liquid level detergent apparatus, remove the apparatus from its location as shown in the picture below, and thoroughly clean the remaining detergent residues. Replace the apparatus. Make sure that no residual material remains inside the siphon.

(\*) Model dependant

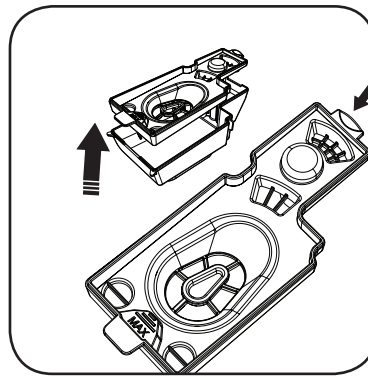
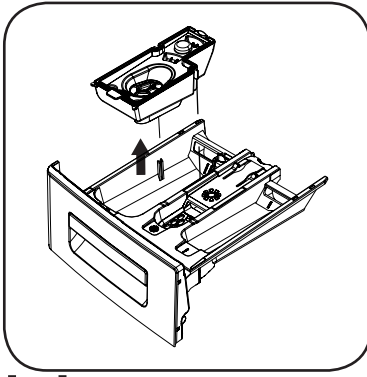

## Siphon cover

Remove the detergent drawer from its place (see page 99).  
Remove the siphon plug as shown in the picture and clean the softener residues thoroughly. Replace the cleaned siphon plug.  
Check whether the it completely fits.

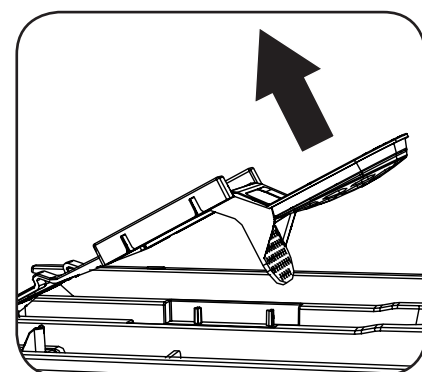
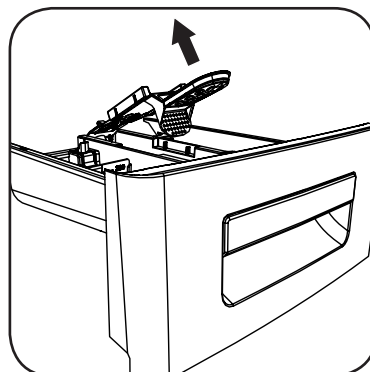
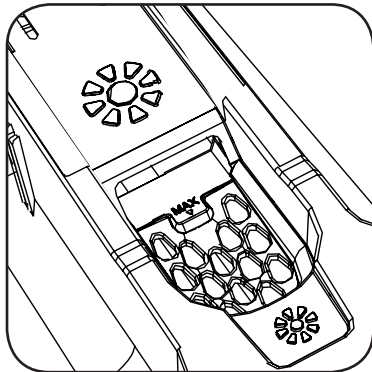

## Drum Cleaning

Do not leave metal parts like needle, paper clip, coins inside your machine. This machines cause rust to form inside the drum.  
Use a non-chloride cleaning agent to clean these rust stains and comply with the warnings of the cleaning agent manufacturer. For the cleaning of the rust stains, denitely do not use wire wool or similar hard objects.

## Body Cleaning

Clean the outer body of your machine with a non-corrosive, inam-mable cleaning agent. After rinsing the body of the machine you cleaned with some clean water, dry with a soft and dry cloth.

## Pump filter maintenance and cleaning

This machine contains a filter system that prevents threads left over from your laundry and other small materials from entering the pump during the discharge operation after a completed wash cycle. This is to protect and prolong the life of the pump. It is recommended that you clean your pump filter once every 2 months.

To clean the pump filter:

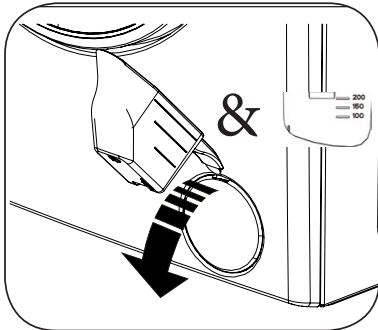

- You may use the washing powder spade supplied with your machine or liquid detergent level plate to open the pump cover.

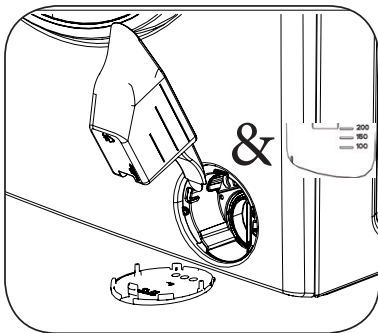

- Lodge the end part of the plastic part to the opening of the cover and press backwards. The cover will be opened.

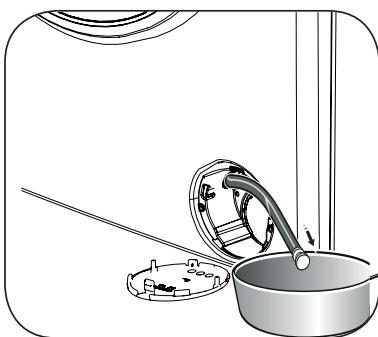

- Pull the black rubber hose and detach it from its clamp, place a container under it and remove its plug.

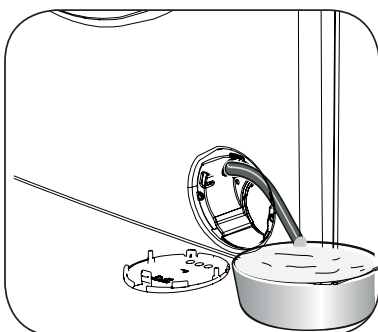

- Collect the discharged water in the container.

Note: According to the amount of water inside the machine, you may have you empty the water collection container a few times.

- Put back the plug of the black rubber hose after discharging the water.
- Mount the black rubber hose back to its clamp.

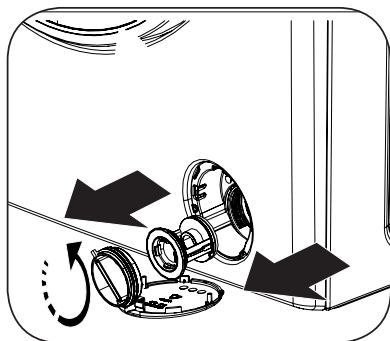

- Loosen the filter cover by turning it counter-clockwise, and remove by pulling.

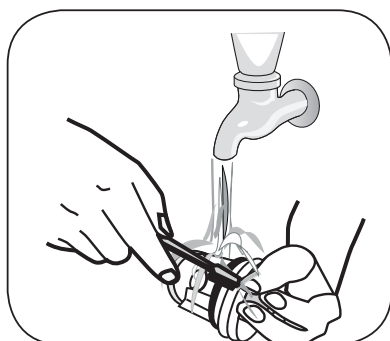

- Clean the foreign materials inside the filter with the help of a brush.

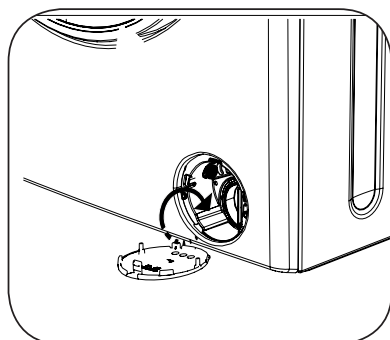

- After cleaning the filter replace the filter cover and tighten by turning clockwise.
- Please note that filter cover will leak water unless properly placed back.

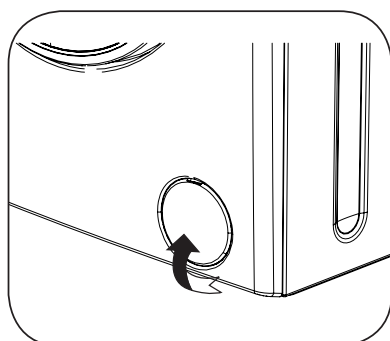

- You can close the pump cover reverse of how you opened it.
- While closing the pump cover, ensure that the parts inside the cover meet the holes on the front panel side.

# Troubleshooting

All repairing operations required for your machine should be carried out by an authorised service company. If your machine requires a repair or if you cannot solve an issue with the information provided below, then you should:

- Unplug the machine.
- Close the water tap.
- Contact the nearest authorised service company.

FAULT	POSSIBLE CAUSE	REMOVING METHODS
Your machine will not start.	It is not plugged in.	Insert the plug into the socket.
	Your fuse is defective.	Change your fuse.
	Mains supply is cut off.	Check the mains supply.
	Start/Pause button is not pressed.	Press the start/pause button.
	The program knob is in stop (off) position.	Bring the program knob on the desired position.
	The door of your machine is not closed properly.	Close the door of your machine.
No water is entering the machine.	Your tap is closed.	Open the tap.
	Check the water inlet hose.	Water inlet hose may be twisted.
	Water inlet hose may be blocked.	Clean the water inlet hose filters. (*)
	Valve inlet filter is blocked.	Clean the valve inlet filters. (*)
	The door of your machine is not closed properly.	Close the door of your machine.

(\*) See page 98



FAULT	POSSIBLE CAUSE	REMOVING METHODS
Your machine does not discharge	Discharging hose clogged or twisted.	Check the discharging hose.
	Pump filter clogged.	Clean the pump (**)filter.
Your machine vibrates.	Your machine's feet are not adjusted.	Adjust the feet of your machine. (***)
	Transportation Safety screws are not removed.	Remove the transportation safety screws from your machine (****)
	Your machine only has a small amount of laundry inside.	This will not prevent the operation of your machine.
	Your machine is overloaded with laundry or the laundry is not distributed evenly.	Do not put more laundry in than the amount recommended and make sure it is loaded evenly.
	Your machine rests on a hard surface.	Avoid installing your machine on hard surfaces. When settling your machine, leave 2 cm space between it and walls or hard surfaces.

(\*\*) See page 101



(\*\*\*) See page 23

(\*\*\*\*) See page 21

FAULT	POSSIBLE CAUSE	REMOVING METHODS
Excessive foam is formed in the detergent drawer.	Excessive amount of detergent used.	Press the Start/Pause button. To eliminate foam formation, mix a spoon of softener with half a litre of water, and pour the mixture in the detergent drawer. After 5-10 minutes, press the Start/Pause button again. In your next washing operation, adjust the detergent dose accordingly.
	Wrong detergent used.	Use detergents produced only for automatic washing machines in your machine.
Unsatisfactory washing result.	The contamination degree of your laundry does not match the programme you have chosen.	Select programmes appropriate for your laundry's level of dirtiness. (See page 78 programme table)
	Amount of detergent used insufficient.	Adjust the level of detergent according to the amount and level of dirtiness of your laundry.
	Your machine has more than the maximum capacity laundry inside the machine.	Load your machine with an amount of laundry that does not exceed the maximum laundry capacity.

FAULT	POSSIBLE CAUSE	REMOVING METHODS
As soon as the machine is loaded with water, water discharges.	The end of the water drain hose is too low for the machine.	Set the water drain hose to an appropriate height. (*****)
No water appears in the drum during washing.	No fault. Water is in the unseen part of the drum.	-
Laundry has detergent residues on them.	Non-dissolving particles of some detergents may adhere to your laundries as white spots.	Perform an extra rinsing by setting your machine to "Rinsing" programme, or clean the spots using a brush after your laundry dries.
Laundry have detergent residues on them.	The reason for these spots may be oil, cream or ointment.	Apply the maximum amount of detergent instructed by the detergent manufacturer in the next washing operation.
Spinning operation is not performed or runs late.	No fault. Unbalanced load control system has been activated.	The unbalanced load control system will try to spread your laundry evenly. The spinning operation will begin after your laundry is spread. Place the laundry in the machine in a balanced fashion next time.

(\*\*\*\*\*) See page 27.

FAULT	POSSIBLE CAUSE	REMOVING METHODS
<p>The load detection system on the screen does not work while loading the machine.</p>	<p>Laundry is placed into the machine without choosing a washing or drying programme.</p>	<p>Remove the laundry in your machine. Switch the programme knob to CANCEL position, reselect the programme you want to select. Load the laundry in the machine and run.</p>
<p> symbol is displayed On screen and machine does not run.</p>	<p>There is more laundry in the machine than the maximum laundry amount for the washing or drying programme you selected.</p>	<p> Remove laundry from your machine until the symbol disappears</p>
<p>Laundry remains damp after the drying operation.</p>	<p>Appropriate drying programme is not selected. The maximum load capacity for the selected programme might be exceeded.</p>	<p>Select a drying programme appropriate for your laundry (see page 78 for the programme table)</p>

# Automatic fault warnings and what needs to be done

Your machine is equipped with systems which are capable of both taking necessary precautions and warning you in case of any breakdown by means of continuous self-checking during washing operations.

## ERROR CODE



Check the door

## POSSIBLE FAULT

The door of your machine is left open.

## WHAT TO DO

Close the machine door.  
If your machine persists to indicate fault, turn off your machine, unplug it and contact the nearest authorised service company immediately.

## ERROR CODE



NO WATER

Check water supply.



## POSSIBLE FAULT

Water cut-off or low mains water pressure.

## WHAT TO DO

- Water tap may be closed. Check.
  - Mains water may be cut-off. Check.
  - If so, switch the programme knob to CANCEL position. You can select a programme and run your machine after the mains water is supplied.
  - Mains water pressure may be low. Check.
  - Water inlet hose may be twisted. Check.
  - Water inlet hose may be clogged.
  - Clean water inlet hose and valve inlet filters.(\*)
- If the problem persists, unplug your machine, turn off your tap and contact the nearest authorised service company.

(\* ) See page 98.

## ERROR CODE



### PUMP

Unplug the machine.

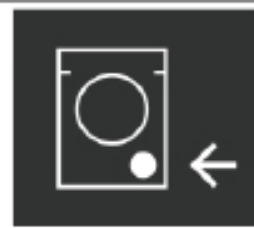

## POSSIBLE FAULT

Pump is damaged, pump filter is clogged or pump electrical connection is malfunctioning.

## WHAT TO DO

Clean the pump(\*\*)filter.  
If the problem persists, contact the nearest authorised service company.

## ERROR CODE



### FILTER

Check filter.

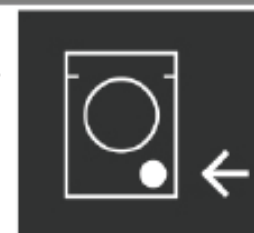

## POSSIBLE FAULT

Pump is damaged or pump filter is clogged or pump electrical connection is malfunctioning.

## WHAT TO DO

- Pump filter may be clogged.
- Clean the pump filter. (\*\*)
- Drain hose may be clogged or twisted.
  - Check the Drain hose.
- If the problem persists, contact the nearest authorised service company.

(\*\*) See page 101.

## ERROR CODE



OVERFLOW

Close tap.



## POSSIBLE FAULT

Your machine has excessive amount of water.

## WHAT TO DO

Your machine will drain water by itself. Pursuant to draining operation, turn off your machine and unplug it. Turn off your faucet and contact the nearest authorised service company.



## ERROR CODE



VOLTAGE

Out of range.



## POSSIBLE FAULT

Mains voltage is high or low.

## WHAT TO DO

There might be a fluctuation on the energy fed to your machine, check if the socket you have your machine plugged into is grounded. Have an electrician measure the amount of voltage coming to your house. If there is no problem in the electricity, unplug your machine and inform the nearest service company.

## **INDEX (page no)**

- A**
  - Adding laundry (74)
  - Additional functions (55)
  - Adjustable foot (19)
  - Adjusting machine settings (32)
  - Adjusting the adjustable foot (23)
  - Adjustment and additional function buttons (28)
  - Anti-allergic additional function (58)
- B**
  - Before using your machine (5)
  - Body cleaning (100)
  - Burn risk (9)
- C**
  - Cancelling a programme (74)
  - Child lock (76)
  - Control panel (28)
  - Correct use (5)
  - Cotton (78)
  - Cotton dry (83)
  - Current time setting (38)
  - Cupboard dry (51)
- D**
  - Death risk (10)
  - Delay Time (63)
  - Detergent drawer compartments (30)
  - Detergent drawer general view (29)
  - Detergent drawer maintenance and cleaning (99)
  - Choice of detergent and placing into the machine (48)
  - Drum cleaning (100)
  - Drying with duration (54)
  - Delicates (81)
  - Duvet (82)
  - Disposing of packaging and your old machine responsibly (16)

## **INDEX (page no)**

- E** Easy ironing additional function (59)
- Eco Time setting (economic time interval) (36)
- Economic time interval additional function (60)
- Electrical connection (25)
- Explanations of washing symbols (44)
- Explosion risk (12)
- Extras (83-85)
- Extra rinse function (57)
- Eco 20° (79)
- Error code (104-105-106-107-108)
- F** Fall and injury risk (14)
- Fault (104)
- Fire risk (12)
- Flooding risk (11)
- Frozen hoses (6)
- Fast 60° 60 mins (86)
- G** General appearance (18-19)
- General warnings (6)
- Gentle dry (83)
- H** Hanger dry (52)
- I** Index (113,114,115,116,117)
- Info screen (28)
- Iron dry (53)

## **INDEX**      **(page no)**

- L**      Language selection setting (32)
- M**      Maintenance and cleaning (97,98,99,100)
  - Max dry laundry capacity kg (20)
  - Max drying capacity kg (20)
  - Memory record function button (65)
  
- P**      Packaging and environment (16)
  - Pausing the programme (74)
  - Placing laundry into the machine (45)
  - Placing the machine ad adjusting the adjustable foot (23)
  - Pre-wash additional function (56)
  - Pre-wash detergent compartment (30)
  - Program selection (50)
  - Programme knob (31)
  - Programme table (78-79-80-81-82-83-84-85-86-87-88-89)
  - Pump 110

## **INDEX (page no)**

- R**
  - Removal of old machine (16)
  - Removal of packaging materials (16)
  - Removing transport safety screws (21)
  - Rinse (84)
  - Refresh (87)
- S**
  - Safety warnings (9)
  - Screen brightness setting (41)
  - Screen contrast setting (41)
  - Selecting sub-programme(Synthetics) (90)
  - Selecting sub-programmes (extras) (94)
  - Selecting sub-programmes (delicates) (92)
  - Sorting laundry (43)
  - Spin (84)
  - Spin speed (20)
  - Start/Pause button (71-28)
  - Starting the programme (71)
  - Super rapid 12 mins (84)
  - Synthetics (80)
  - Sound adjustment (40)
  - Siphon cover (100)

## **INDEX (page no)**

- T**      Technical specifications (20)
- Troubleshooting (103)
- W**      Wash & Dry 29 min (88)
- Water draining connection (27)
- Water inlet connection (26)
- Water inlet filters (98)
- Water pressure (20)
- Wool (81)



**CALL CENTER**

**44 44 123**

**www.vestel.com.tr**



The lifetime of your product (the period during which the spare parts will be provided for its proper functioning) evaluated and announced by the Ministry of Customs and Trade is 10 years



**Producer Company:**

Vestel Beyaz Eşya Sanayi ve Ticaret A.Ş.  
Organize Sanayi Bölgesi 45030 Manisa - Türkiye  
Phone: 44 44 123 Fax: (0212) 321 17 90

**VESTEL**