



SiUS25 - 501

Service Manual

Split System Air Conditioners SkyAir Inverter

R-410A Heat Pump 60Hz
M Series

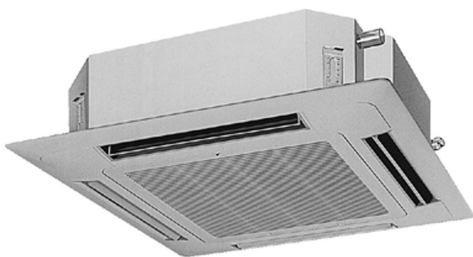

SkyAir Inverter M Series R-410A Heat Pump 60Hz

1. Introduction	V
1.1 Safety Cautions.....	V
Part 1 General Information.....	1
1. Model Names and Power Supply.....	2
2. External Appearance	3
2.1 Indoor Units.....	3
2.2 Outdoor Units.....	3
Part 2 Specifications	5
1. Specifications.....	6
1.1 FCQ	6
1.2 FHQ	8
Part 3 List of Electrical and Functional Parts	11
1. List of Electrical and Functional Parts.....	12
1.1 Outdoor Units.....	12
1.2 Indoor Units.....	13
Part 4 Refrigerant Circuit.....	15
1. Refrigerant Circuit	16
1.1 RZQ24-30-36-42MVJU.....	16
2. Functional Parts Layout	18
2.1 RZQ24-30-36-42MVJU.....	18
Part 5 Function	19
1. Operation Mode	20
2. Basic Control.....	21
2.1 Normal Operation.....	21
2.2 Compressor PI Control	22
2.3 Electronic Expansion Valve PI Control	23
2.4 Cooling Operation Fan Control	24
3. Special Control.....	25
3.1 Startup Control.....	25
3.2 Oil Return Operation	26
3.3 Defrosting Operation.....	28
3.4 Pump-down Residual Operation	29
3.5 Restart Standby	30
3.6 Stopping Operation	31

3.7	Pressure Equalization Prior to Startup	32
4.	Protection Control	33
4.1	High Pressure Protection Control	33
4.2	Low Pressure Protection Control	34
4.3	Discharge Pipe Protection Control	35
4.4	Inverter Protection Control	36
5.	Other Control	37
5.1	Heating Operation Prohibition	37
6.	Outline of Control (Indoor Unit)	38
6.1	Drain Pump Control	38
6.2	Louver Control for Preventing Ceiling Dirt	40
6.3	Thermostat Sensor in Remote Controller	41
6.4	Freeze Prevention.....	43
6.5	View of Operations of Swing Flaps	44

Part 6 Test Operation 45

1.	Test Operation	46
1.1	Procedure and Outline	46
1.2	Operation When Power is Turned On.....	49
2.	Outdoor Unit PC Board Layout	50
3.	Field Setting	51
3.1	Field Setting from Remote Controller.....	51
3.2	Field Setting from Outdoor Unit	62
3.3	Detail of Setting Mode.....	68

Part 7 Troubleshooting 79

1.	Troubleshooting by Remote Controller	82
1.1	The INSPECTION / TEST Button	82
1.2	Self-Diagnosis by Wired Remote Controller.....	83
1.3	Self-Diagnosis by Wireless Remote Controller	84
1.4	Operation of the Remote Controller's Inspection / Test Operation Button.....	86
1.5	Remote Controller Service Mode	87
2.	List of Malfunction Code	89
3.	Malfunction Code Indication by Outdoor Unit PCB	92
4.	Troubleshooting by Indication on the Remote Controller	94
4.1	"R0" Indoor Unit: Error of External Protection Device	94
4.2	"R1" Indoor Unit: PC Board Defect	95
4.3	"R3" Indoor Unit: Malfunction of Drain Level Control System (S1L).....	96
4.4	"R5" Indoor Unit: Fan Motor (M1F) Lock, Overload	98
4.5	"R7" Indoor Unit: Malfunction of Swing Flap Motor (MA).....	99
4.6	"R9" Indoor Unit: Malfunction of Moving Part of Electronic Expansion Valve (20E).....	101
4.7	"RF" Indoor Unit: Drain Level above Limit	103
4.8	"RJ" Indoor Unit: Malfunction of Capacity Determination Device.....	104

4.9	“C4” Indoor Unit: Malfunction of Thermistor (R2T) for Heat Exchanger	105
4.10	“C5” Indoor Unit: Malfunction of Thermistor (R3T) for Gas Pipes	106
4.11	“C9” Indoor Unit: Malfunction of Thermistor (R1T) for Suction Air	107
4.12	“CJ” Indoor Unit: Malfunction of Thermostat Sensor in Remote Controller	108
4.13	“E1” Outdoor Unit: PC Board Defect	109
4.14	“E3” Outdoor Unit: Actuation of High Pressure Switch	110
4.15	“E4” Outdoor Unit: Actuation of Low Pressure Switch	111
4.16	“E5” Outdoor Unit: Compressor Motor Lock	113
4.17	“E7” Outdoor Unit: Malfunction of Outdoor Unit Fan Motor	114
4.18	“E9” Outdoor Unit: Malfunction of Moving Part of Electronic Expansion Valve	116
4.19	“F3” Outdoor Unit: Abnormal Discharge Pipe Temperature	118
4.20	“H9” Outdoor Unit: Malfunction of Thermistor (R1T) for Outdoor Air	119
4.21	“J3” Outdoor Unit: Malfunction of Discharge Pipe Thermistor (R3T)	120
4.22	“J5” Outdoor Unit: Malfunction of Thermistor (R2T) for Suction Pipe...	121
4.23	“J6” Outdoor Unit: Malfunction of Thermistor (R4T) for Outdoor Unit Heat Exchanger Deicer	122
4.24	“J9” Outdoor Unit: Malfunction of Subcooling Heat Exchanger Gas Pipe Thermistor (R5T)	123
4.25	“JR” Outdoor Unit: Malfunction of High Pressure Sensor	124
4.26	“JC” Outdoor Unit: Malfunction of Low Pressure Sensor	126
4.27	“L4” Outdoor Unit: Malfunction of Inverter Radiating Fin Temperature Rise	127
4.28	“L5” Outdoor Unit: Inverter Compressor Abnormal	128
4.29	“L8” Outdoor Unit: Inverter Current Abnormal	129
4.30	“L9” Outdoor Unit: Inverter Start up Error	131
4.31	“LC” Outdoor Unit: Malfunction of Transmission between Inverter and Control PC Board	132
4.32	“P4” Outdoor Unit: Malfunction of Inverter Radiating Fin Temperature Rise Sensor	134
4.33	“PJ” Outdoor Unit: Faulty Combination of Inverter and Fan Driver	135
4.34	“U0” Outdoor Unit: Low Pressure Drop Due to Refrigerant Shortage or Electronic Expansion Valve Failure	136
4.35	“U2” Outdoor Unit: Power Supply Insufficient or Instantaneous Failure	137
4.36	“U3” Outdoor Unit: Check Operation not Executed	139
4.37	“U4” Malfunction of Transmission between Indoor Units and Outdoor Units	140
4.38	“U5” Indoor Unit: Malfunction of Transmission between Remote Controller and Indoor Unit	142
4.39	“U8” Indoor Unit: Malfunction of Transmission between Main and Sub Remote Controllers	143
4.40	“U9” Indoor Unit: Malfunction of Transmission between Indoor Units and Outdoor Units in the Same System	144
4.41	“UR” Improper Combination of Indoor Units and Outdoor Units, Indoor Units and Remote Controller	146
4.42	“UC” Address Duplication of Centralized Controller	147

- 4.43 “UE” Malfunction of Transmission between Centralized Controller and Indoor Unit..... 148
- 4.44 “UF” System is not Set yet..... 150
- 4.45 “UH” Malfunction of System, Refrigerant System Address Undefined..... 151
- 5. Troubleshooting by Indication on the Central Remote Controller 152
 - 5.1 “PI” PC Board Defect..... 152
 - 5.2 “PB” Malfunction of Transmission between Optional Controllers for Centralized Control 153
 - 5.3 “PR” Improper Combination of Optional Controllers for Centralized Control 154
 - 5.4 “PL” Address Duplication, Improper Setting..... 156
- 6. Troubleshooting by Indication on the Unified ON/OFF Controller..... 157
 - 6.1 Operation Lamp Blinks..... 157
 - 6.2 Display “Under Centralized Control” Blinks (Repeats Single Blink) 159
 - 6.3 Display “Under Centralized Control” Blinks (Repeats Double Blink).... 162
- 7. Troubleshooting (OP: Schedule Timer) 163
 - 7.1 “UE” Malfunction of Transmission between Centralized Controller and Indoor Unit..... 163
 - 7.2 “PI” PC Board Defect..... 165
 - 7.3 “PB” Malfunction of Transmission between Optional Controllers for Centralized Control 166
 - 7.4 “PR” Improper Combination of Optional Controllers for Centralized Control 167
 - 7.5 “PL” Address Duplication, Improper Setting..... 169
- 8. Check..... 170

Part 8 Appendix 173

- 1. Piping Diagrams..... 174
 - 1.1 Outdoor Unit..... 174
 - 1.2 Indoor Unit 175
- 2. Wiring Diagrams for Reference..... 176
 - 2.1 Outdoor Unit..... 176
 - 2.2 Indoor Unit 177
- 3. Thermistor Resistance / Temperature Characteristics..... 179
- 4. Pressure Sensor 181

Part 9 Precautions for New Refrigerant (R-410A) 183

- 1. Precautions for New Refrigerant (R-410A) 184
 - 1.1 Outline..... 184
 - 1.2 Service Tools 186





Index i

Drawings & Flow Chartsv







1. Introduction







1.1 Safety Cautions

Cautions and Warnings

- Be sure to read the following safety cautions before conducting repair work.
- The caution items are classified into “ **Warning**” and “ **Caution**”. The “ **Warning**” items are especially important since they can lead to death or serious injury if they are not followed closely. The “ **Caution**” items can also lead to serious accidents under some conditions if they are not followed. Therefore, be sure to observe all the safety caution items described below.
- About the pictograms
 - △ This symbol indicates an item for which caution must be exercised.
The pictogram shows the item to which attention must be paid.
 - This symbol indicates a prohibited action.
The prohibited item or action is shown inside or near the symbol.
 - This symbol indicates an action that must be taken, or an instruction.
The instruction is shown inside or near the symbol.
- After the repair work is complete, be sure to conduct a test operation to ensure that the equipment operates normally, and explain the cautions for operating the product to the customer



1.1.1 Caution in Repair



 Warning	
Be sure to disconnect the power cable plug from the plug socket before disassembling the equipment for a repair. Working on the equipment that is connected to a power supply can cause an electrical shock. If it is necessary to supply power to the equipment to conduct the repair or inspecting the circuits, do not touch any electrically charged sections of the equipment.	
If the refrigerant gas discharges during the repair work, do not touch the discharging refrigerant gas. The refrigerant gas can cause frostbite.	
When disconnecting the suction or discharge pipe of the compressor at the welded section, release the refrigerant gas completely at a well-ventilated place first. If there is a gas remaining inside the compressor, the refrigerant gas or refrigerating machine oil discharges when the pipe is disconnected, and it can cause injury.	
If the refrigerant gas leaks during the repair work, ventilate the area. The refrigerant gas can generate toxic gases when it contacts flames.	
The step-up capacitor supplies high-voltage electricity to the electrical components of the outdoor unit. Be sure to discharge the capacitor completely before conducting repair work. A charged capacitor can cause an electrical shock.	
Do not start or stop the air conditioner operation by plugging or unplugging the power cable plug. Plugging or unplugging the power cable plug to operate the equipment can cause an electrical shock or fire.	

 Caution	
Do not repair the electrical components with wet hands. Working on the equipment with wet hands can cause an electrical shock.	
Do not clean the air conditioner by splashing water. Washing the unit with water can cause an electrical shock.	
Be sure to provide the grounding when repairing the equipment in a humid or wet place, to avoid electrical shocks.	
Be sure to turn off the power switch and unplug the power cable when cleaning the equipment. The internal fan rotates at a high speed, and cause injury.	
Do not tilt the unit when removing it. The water inside the unit can spill and wet the furniture and floor.	
Be sure to check that the refrigerating cycle section has cooled down sufficiently before conducting repair work. Working on the unit when the refrigerating cycle section is hot can cause burns.	
Use the welder in a well-ventilated place. Using the welder in an enclosed room can cause oxygen deficiency.	



1.1.2 Cautions Regarding Products after Repair



 Warning	
Be sure to use parts listed in the service parts list of the applicable model and appropriate tools to conduct repair work. Never attempt to modify the equipment. The use of inappropriate parts or tools can cause an electrical shock, excessive heat generation or fire.	
When relocating the equipment, make sure that the new installation site has sufficient strength to withstand the weight of the equipment. If the installation site does not have sufficient strength and if the installation work is not conducted securely, the equipment can fall and cause injury.	
Be sure to install the product correctly by using the provided standard installation frame. Incorrect use of the installation frame and improper installation can cause the equipment to fall, resulting in injury.	For integral units only
Be sure to install the product securely in the installation frame mounted on a window frame. If the unit is not securely mounted, it can fall and cause injury.	For integral units only



 Warning	
Be sure to use an exclusive power circuit for the equipment, and follow the technical standards related to the electrical equipment, the internal wiring regulations and the instruction manual for installation when conducting electrical work. Insufficient power circuit capacity and improper electrical work can cause an electrical shock or fire.	
Be sure to use the specified cable to connect between the indoor and outdoor units. Make the connections securely and route the cable properly so that there is no force pulling the cable at the connection terminals. Improper connections can cause excessive heat generation or fire.	
When connecting the cable between the indoor and outdoor units, make sure that the terminal cover does not lift off or dismount because of the cable. If the cover is not mounted properly, the terminal connection section can cause an electrical shock, excessive heat generation or fire.	
Do not damage or modify the power cable. Damaged or modified power cable can cause an electrical shock or fire. Placing heavy items on the power cable, and heating or pulling the power cable can damage the cable.	
Do not mix air or gas other than the specified refrigerant in the refrigerant system. If air enters the refrigerating system, an excessively high pressure results, causing equipment damage and injury.	
If the refrigerant gas leaks, be sure to locate the leak and repair it before charging the refrigerant. After charging refrigerant, make sure that there is no refrigerant leak. If the leak cannot be located and the repair work must be stopped, be sure to perform pump-down and close the service valve, to prevent the refrigerant gas from leaking into the room. The refrigerant gas itself is harmless, but it can generate toxic gases when it contacts flames, such as fan and other heaters, stoves and ranges.	
When replacing the coin battery in the remote controller, be sure to disposed of the old battery to prevent children from swallowing it. If a child swallows the coin battery, see a doctor immediately.	

 Caution	
Installation of a leakage breaker is necessary in some cases depending on the conditions of the installation site, to prevent electrical shocks.	
Do not install the equipment in a place where there is a possibility of combustible gas leaks. If a combustible gas leaks and remains around the unit, it can cause a fire.	
Be sure to install the packing and seal on the installation frame properly. If the packing and seal are not installed properly, water can enter the room and wet the furniture and floor.	For integral units only

1.1.3 Inspection after Repair

 Warning	
Check to make sure that the power cable plug is not dirty or loose, then insert the plug into a power outlet all the way. If the plug has dust or loose connection, it can cause an electrical shock or fire.	





 Warning	
If the power cable and lead wires have scratches or deteriorated, be sure to replace them. Damaged cable and wires can cause an electrical shock, excessive heat generation or fire.	
Do not use a joined power cable or extension cable, or share the same power outlet with other electrical appliances, since it can cause an electrical shock, excessive heat generation or fire.	

 Caution	
Check to see if the parts and wires are mounted and connected properly, and if the connections at the soldered or crimped terminals are secure. Improper installation and connections can cause excessive heat generation, fire or an electrical shock.	
If the installation platform or frame has corroded, replace it. Corroded installation platform or frame can cause the unit to fall, resulting in injury.	
Check the grounding, and repair it if the equipment is not properly grounded. Improper grounding can cause an electrical shock.	
Be sure to measure the insulation resistance after the repair, and make sure that the resistance is 1 Mohm or higher. Faulty insulation can cause an electrical shock.	
Be sure to check the drainage of the indoor unit after the repair. Faulty drainage can cause the water to enter the room and wet the furniture and floor.	

1.1.4 Using Icons

Icons are used to attract the attention of the reader to specific information. The meaning of each icon is described in the table below:

1.1.5 Using Icons List

Icon	Type of Information	Description
 Note:	Note	A “note” provides information that is not indispensable, but may nevertheless be valuable to the reader, such as tips and tricks.
 Caution	Caution	A “caution” is used when there is danger that the reader, through incorrect manipulation, may damage equipment, loose data, get an unexpected result or has to restart (part of) a procedure.
 Warning	Warning	A “warning” is used when there is danger of personal injury.
	Reference	A “reference” guides the reader to other places in this binder or in this manual, where he/she will find additional information on a specific topic.

Part 1

General Information

1. Model Names and Power Supply.....	2
2. External Appearance	3
2.1 Indoor Units.....	3
2.2 Outdoor Units.....	3

1. Model Names and Power Supply

Indoor Unit		Outdoor Unit	Power Supply
Ceiling Mounted Cassette Type (Multi Flow)	FCQ24MVJU	RZQ24MVJU	VJ : 1 ϕ , 208~230V, 60Hz
	FCQ30MVJU	RZQ30MVJU	
	FCQ36MVJU	RZQ36MVJU	
	FCQ42MVJU	RZQ42MVJU	
Ceiling Suspended Type	FHQ24MVJU	RZQ24MVJU	
	FHQ30MVJU	RZQ30MVJU	
	FHQ36MVJU	RZQ36MVJU	
	FHQ42MVJU	RZQ42MVJU	

2. External Appearance

2.1 Indoor Units

Ceiling Mounted Cassette Type (Multi Flow)

FCQ24MVJU
FCQ30MVJU
FCQ36MVJU
FCQ42MVJU

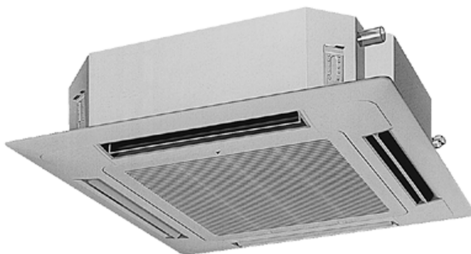

Ceiling Suspended Type

FHQ24MVJU
FHQ30MVJU
FHQ36MVJU
FHQ42MVJU



2.2 Outdoor Units

RZQ24MVJU
RZQ30MVJU
RZQ36MVJU
RZQ42MVJU

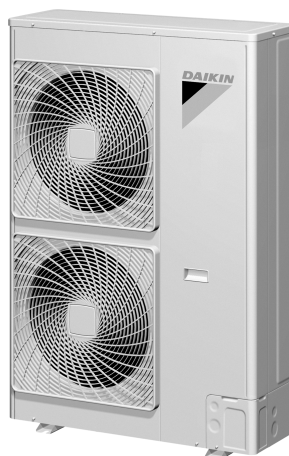

Part 2

Specifications

1. Specifications	6
1.1 FCQ	6
1.2 FHQ	8

1. Specifications

1.1 FCQ

Ceiling Mounted Cassette Type

Model	Indoor Unit			FCQ24MVJU			FCQ30MVJU				
	Outdoor Unit			RZQ24MVJU			RZQ30MVJU				
*1 Cooling Capacity	Btu/h			24,000			30,000				
*2 Heating Capacity	Btu/h			27,000			34,000				
Indoor Unit				FCQ24MVJU			FCQ30MVJU				
Dimensions	HxWxD	in.		11-3/8 x 33-1/8 x 33-1/8			11-3/8 x 33-1/8 x 33-1/8				
Coil	Type	Cross Fin Coil									
	RowsxStagesxFPI	2x12x17			2x12x17						
	Face Area	ft²		5.35			5.35				
Fan	Model	QTS45A17M			QTS45A17M						
	Type	Turbo Fan									
	Motor Output	W		90			90				
	Air Flow Rate (H/L)	cfm		(Cooling) 790/670 (Heating) 870/670			900/790				
Air Filter				—			—				
Mass (Weight)				Lbs		73			73		
Piping Connections	Liquid	in.		φ3/8 (Flare Connection)			φ3/8 (Flare Connection)				
	Gas	in.		φ5/8 (Flare Connection)			φ5/8 (Flare Connection)				
	Drain	in.		VP25 (External Dia. 1-1/4, Internal Dia. 1)			VP25 (External Dia. 1-1/4, Internal Dia. 1)				
Remote Controller (Option)	Wired		BRC1C71								
	Wireless		BRC7C812								
Decoration Panels (Option)	Model			BYC125K-W19							
	Color			White (10Y9/0.5)							
	Dimensions	HxWxD	in.		1-5/8 x 37-3/8 x 37-3/8			1-5/8 x 37-3/8 x 37-3/8			
	Air Filter				Resin Net (with Mold Resistant)			Resin Net (with Mold Resistant)			
	Weight				Lbs		11			11	
Outdoor Unit				RZQ24MVJU			RZQ30MVJU				
Color				Ivory White (5Y7.5/1)							
Dimensions	HxWxD	in.		52-15/16 x 35-7/16 x 12-5/8			52-15/16 x 35-7/16 x 12-5/8				
Coil	Type	Cross Fin Coil									
	RowsxStagesxFPI	2x60x13			2x60x13						
	Face Area	ft²		12.2			12.2				
Comp.	Model	JT100FCVDK@4			JT100FCVDK@4						
	Type	Hermetically Sealed Scroll Type									
	Motor Output	kW		1.6			2.0				
Fan	Model	KFD-325-70-8A			KFD-325-70-8A						
	Type	Propeller Fan									
	Motor Output	W		70x2			70x2				
	Air Flow Rate	cfm		3,740			3,740				
Mass (Weight)				Lbs		310			310		
Piping Connections	Liquid	in.		φ3/8 (Flare Connection)			φ3/8 (Flare Connection)				
	Gas	in.		φ5/8 (Flare Connection)			φ5/8 (Flare Connection)				
	Drain	in.		φ1 (Hole)			φ1 (Hole)				
Safety Devices				High Pressure Switch. Outdoor Fan Driver Overload Protector. Thermal Protector for Indoor Fan Motor. Inverter Overload Protector. Fusible Plugs. Fuse.							
Refrigerant Control				Electronic Expansion Valve							
Ref. Piping	Standard Length	ft		25			25				
	Max. Length	ft		230			230				
	Max. Height Difference	ft		164			164				
Refrigerant	Model	R-410A			R-410A						
	Charge (Factory Charge)	Lbs		12.8			12.8				
Ref. Oil	Model	Refer to the name plate of compressor.									
	Charge	L		1.6			1.6				
Drawing No.				C : 4D049128							

Note:

1. The above data are based on the following conditions.

Cooling *1	Heating *2	Equivalent Piping Length	Hz, Volts
Indoor : 80°FDB, 67°FWB Outdoor : 95°FDB	Indoor : 70°FDB Outdoor : 47°FDB, 43°FWB	25ft (Level Difference : 0)	60Hz, 230V

2. Capacities are net, including a deduction for cooling (an addition for heating) for indoor fan motor heat.

Ceiling Mounted Cassette Type

Model	Indoor Unit		FCQ36MVJU		FCQ42MVJU	
	Outdoor Unit		RZQ36MVJU		RZQ42MVJU	
*1 Cooling Capacity	Btu/h		36,000		40,500	
*2 Heating Capacity	Btu/h		39,500		41,500	
Indoor Unit			FCQ36MVJU		FCQ36MVJU	
Dimensions	HxWxD	in.	11-3/8 x 33-1/8 x 33-1/8		11-3/8 x 33-1/8 x 33-1/8	
Coil	Type		Cross Fin Coil			
	RowsxStagesxFPI		2x12x17		2x12x17	
	Face Area	ft ²	5.35		5.35	
Fan	Model		QTS45A17M		QTS45A17M	
	Type		Turbo Fan			
	Motor Output	W	90		90	
	Air Flow Rate (H/L)	cfm	950/790		1,030/870	
Air Filter			—		—	
Mass (Weight)		Lbs	74		74	
Piping Connections	Liquid	in.	φ3/8 (Flare Connection)		φ3/8 (Flare Connection)	
	Gas	in.	φ5/8 (Flare Connection)		φ5/8 (Flare Connection)	
	Drain	in.	VP25 (External Dia. 1-1/4, Internal Dia. 1)		VP25 (External Dia. 1-1/4, Internal Dia. 1)	
Remote Controller (Option)	Wired	BRC1C71				
	Wireless	BRC7C812				
Decoration Panels (Option)	Model		BYC125K-W19			
	Color		White (10Y9/0.5)			
	Dimensions	HxWxD in.	1-5/8 x 37-3/8 x 37-3/8		1-5/8 x 37-3/8 x 37-3/8	
	Air Filter		Resin Net (with Mold Resistant)		Resin Net (with Mold Resistant)	
	Weight	Lbs	11		11	
Outdoor Unit			RZQ36MVJU		RZQ42MVJU	
Color			Ivory White (5Y7.5/1)			
Dimensions	HxWxD	in.	52-15/16 x 35-7/16 x 12-5/8		52-15/16 x 35-7/16 x 12-5/8	
Coil	Type		Cross Fin Coil			
	RowsxStagesxFPI		2x60x13		2x60x13	
	Face Area	ft ²	12.2		12.2	
Comp.	Model		JT100FCVDK@4		JT100FCVDK@4	
	Type		Hermetically Sealed Scroll Type			
	Motor Output	kW	2.5		3.0	
Fan	Model		KFD-325-70-8A		KFD-325-70-8A	
	Type		Propeller Fan			
	Motor Output	W	70x2		70x2	
	Air Flow Rate	cfm	3,740		3,740	
Mass (Weight)			Lbs		310	
Piping Connections	Liquid	in.	φ3/8 (Flare Connection)		φ3/8 (Flare Connection)	
	Gas	in.	φ5/8 (Flare Connection)		φ5/8 (Flare Connection)	
	Drain	in.	φ1 (Hole)		φ1 (Hole)	
Safety Devices			High Pressure Switch. Outdoor Fan Driver Overload Protector. Thermal Protector for Indoor Fan Motor. Inverter Overload Protector. Fusible Plugs. Fuse.			
Refrigerant Control			Electronic Expansion Valve			
Ref. Piping	Standard Length	ft	25		25	
	Max. Length	ft	230		230	
	Max. Height Difference	ft	164		164	
Refrigerant	Model		R-410A		R-410A	
	Charge (Factory Charge)	Lbs	12.8		12.8	
Ref. Oil	Model		Refer to the name plate of compressor.			
	Charge	L	1.6		1.6	
Drawing No.			C : 4D049128			

Note:

1. The above data are based on the following conditions.

Cooling *1	Heating *2	Equivalent Piping Length	Hz, Volts
Indoor : 80°FDB, 67°FWB Outdoor : 95°FDB	Indoor : 70°FDB Outdoor : 47°FDB, 43°FWB	25ft (Level Difference : 0)	60Hz, 230V

2. Capacities are net, including a deduction for cooling (an addition for heating) for indoor fan motor heat.

1.2 FHQ

Ceiling Suspended Type

Model	Indoor Unit		FHQ24MVJU	FHQ30MVJU
	Outdoor Unit		RZQ24MVJU	RZQ30MVJU
*1 Cooling Capacity	Btu/h		24,000	30,000
*2 Heating Capacity	Btu/h		27,000	34,000
Indoor Unit		FHQ24MVJU		FHQ30MVJU
Color		White (10Y9/0.5)		
Dimensions	HxWxD	in.	7-11/16 x 62-5/8 x 26-3/4	7-11/16 x 62-5/8 x 26-3/4
Coil	Type	Cross Fin Coil		
	RowsxStagesxFPI	2x12x15 + 2x10x15		2x12x15 + 2x10x15
	Face Area	ft²	3.66+2.95	3.66+2.95
Fan	Model	—		
	Type	Sirocco Fan		
	Motor Output	W	130	130
	Air Flow Rate (H/L)	cfm	790/670	790/670
Air Filter		Resin Net (With Mold Resistant)		
Mass (Weight)	Lbs	90		90
Piping Connections	Liquid	in.	φ3/8 (Flare Connection)	φ3/8 (Flare Connection)
	Gas	in.	φ5/8 (Flare Connection)	φ5/8 (Flare Connection)
	Drain	in.	VP20 (External Dia. 1, Internal Dia. 3/4)	VP20 (External Dia. 1, Internal Dia. 3/4)
Remote Controller (Option)	Wired	BRC1C71		
	Wireless	BRC7E83		
Outdoor Unit		RZQ24MVJU		RZQ30MVJU
Color		Ivory White (5Y7.5/1)		
Dimensions	HxWxD	in.	52-15/16 x 35-7/16 x 12-5/8	52-15/16 x 35-7/16 x 12-5/8
Coil	Type	Cross Fin Coil		
	RowsxStagesxFPI	2x60x13		2x60x13
	Face Area	ft²	12.2	12.2
Comp.	Model	JT100FCVDK@4		
	Type	Hermetically Sealed Scroll Type		
	Motor Output	kW	1.6	2.0
Fan	Model	KFD-325-70-8A		KFD-325-70-8A
	Type	Propeller Fan		
	Motor Output	W	70x2	70x2
	Air Flow Rate	cfm	3,740	3,740
Mass (Weight)	Lbs	310		310
Piping Connections	Liquid	in.	φ3/8 (Flare Connection)	φ3/8 (Flare Connection)
	Gas	in.	φ5/8 (Flare Connection)	φ5/8 (Flare Connection)
	Drain	in.	φ1 (Hole)	φ1 (Hole)
Safety Devices		High Pressure Switch. Outdoor Fan Driver Overload Protector. Thermal Protector for Indoor Fan Motor. Inverter Overload Protector. Fusible Plugs. Fuse.		
Refrigerant Control		Electronic Expansion Valve		
Ref. Piping	Standard Length	ft	25	25
	Max. Length	ft	230	230
	Max. Height Difference	ft	164	164
Refrigerant	Model	R-410A		
	Charge (Factory Charge)	Lbs	12.8	12.8
Ref. Oil	Model	Refer to the name plate of compressor.		
	Charge	L	1.6	1.6
Drawing No.		C : 4D049325		

Note:

1. The above data are based on the following conditions.

Cooling *1	Heating *2	Equivalent Piping Length	Hz, Volts
Indoor : 80°FDB, 67°FWB Outdoor : 95°FDB	Indoor : 70°FDB Outdoor : 47°FDB, 43°FWB	25ft (Level Difference : 0)	60Hz, 230V

2. Capacities are net, including a deduction for cooling (an addition for heating) for indoor fan motor heat.

Ceiling Suspended Type

Model		Indoor Unit		FHQ36MVJU		FHQ42MVJU	
		Outdoor Unit		RZQ36MVJU		RZQ42MVJU	
*1 Cooling Capacity		Btu/h		36,000		40,500	
*2 Heating Capacity		Btu/h		37,500		39,500	
Indoor Unit				FHQ36MVJU		FHQ42MVJU	
Color				White (10Y9/0.5)			
Dimensions		HxWxD in.		7-11/16 x 62-5/8 x 26-3/4		7-11/16 x 62-5/8 x 26-3/4	
Coil		Type		Cross Fin Coil			
		RowsxStagesxFPI		2x12x15 + 2x10x15		2x12x15 + 2x10x15	
		Face Area ft²		3.66+2.95		3.66+2.95	
Fan		Model		—		—	
		Type		Sirocco Fan			
		Motor Output W		130		130	
		Air Flow Rate (H/L) cfm		830/670		850/700	
Air Filter				Resin Net (With Mold Resistant)			
Mass (Weight)		Lbs		90		90	
Piping Connections		Liquid in.		φ3/8 (Flare Connection)		φ3/8 (Flare Connection)	
		Gas in.		φ5/8 (Flare Connection)		φ5/8 (Flare Connection)	
		Drain in.		VP20 (External Dia. 1, Internal Dia. 3/4)		VP20 (External Dia. 1, Internal Dia. 3/4)	
Remote Controller (Option)		Wired		BRC1C71			
		Wireless		BRC7E83			
Outdoor Unit				RZQ36MVJU		RZQ42MVJU	
Color				Ivory White (5Y7.5/1)			
Dimensions		HxWxD in.		52-15/16 x 35-7/16 x 12-5/8		52-15/16 x 35-7/16 x 12-5/8	
Coil		Type		Cross Fin Coil			
		RowsxStagesxFPI		2x60x13		2x60x13	
		Face Area ft²		12.2		12.2	
Comp.		Model		JT100FCVDK@4		JT100FCVDK@4	
		Type		Hermetically Sealed Scroll Type			
		Motor Output kW		2.5		3.0	
Fan		Model		KFD-325-70-8A		KFD-325-70-8A	
		Type		Propeller Fan			
		Motor Output W		70x2		70x2	
		Air Flow Rate cfm		3,740		3,740	
Mass (Weight)		Lbs		310		310	
Piping Connections		Liquid in.		φ3/8 (Flare Connection)		φ3/8 (Flare Connection)	
		Gas in.		φ5/8 (Flare Connection)		φ5/8 (Flare Connection)	
		Drain in.		φ1 (Hole)		φ1 (Hole)	
Safety Devices				High Pressure Switch. Outdoor Fan Driver Overload Protector. Thermal Protector for Indoor Fan Motor. Inverter Overload Protector. Fusible Plugs. Fuse.			
Refrigerant Control				Electronic Expansion Valve			
Ref. Piping		Standard Length ft		25		25	
		Max. Length ft		230		230	
		Max. Height Difference ft		164		164	
Refrigerant		Model		R-410A		R-410A	
		Charge (Factory Charge) Lbs		12.8		12.8	
Ref. Oil		Model		Refer to the name plate of compressor.			
		Charge L		1.6		1.6	
Drawing No.				C : 4D049325			

Note:

1. The above data are based on the following conditions.

Cooling *1	Heating *2	Equivalent Piping Length	Hz, Volts
Indoor : 80°FDB, 67°FWB Outdoor : 95°FDB	Indoor : 70°FDB Outdoor : 47°FDB, 43°FWB	25ft (Level Difference : 0)	60Hz, 230V

2. Capacities are net, including a deduction for cooling (an addition for heating) for indoor fan motor heat.

Part 3

List of Electrical and Functional Parts

1. List of Electrical and Functional Parts.....	12
1.1 Outdoor Units.....	12
1.2 Indoor Units.....	13

1. List of Electrical and Functional Parts

1.1 Outdoor Units

Item	Name		Symbol	Model				Remark (PCB terminal)
				RZQ24 MVJU	RZQ30 MVJU	RZQ36 MVJU	RZQ42 MVJU	
Compressor	Inverter	Type	M1C	JT100FCVDK@4 3.2kW				—
		Output						
	Crankcase heater (INV)		E1HC	33W				A1P X6A
Fan motor	Motor		M1F-M2F	0.07kW				—
	Over-current relay		—	3.2A				—
Functional parts	Electronic expansion valve (Main)	Cooling	Y1E	1400pls				A1P X26A
		Heating		PI control				
	Electronic expansion valve (Subcool)	Cooling	Y2E	PI control				A1P X28A
		Heating		0pls				
	Solenoid valve (Hot gas)		Y1S	TEV1620DQ2				A1P X2A
	Solenoid valve (Receiver gas charge)		Y2S	TEV1620DQ2				A1P X3A
4 way valve		Y3S	VT40100				A1P X5A	
Pressure-related parts	Pressure switch (INV)		S1PH	ACB-4UB10 ON: 580+0/-22 psi OFF: 435±22 psi				A2P X60A
	Fusible plug		—	FPGH-3D 158~167°F				—
	Pressure sensor (HP)		S1NPH	PS8051A 0~602 psi				A1P X46A
	Pressure sensor (LP)		S1NPL	PS8051A -7~247 psi				A1P X45A
Thermistor	Main PC board	For outdoor air	R1T	3.5~360kΩ				A1P X44A
		For suction pipe	R2T	3.5~360kΩ				A1P X37A 1-2Pin
		For discharge pipe	R3T	3.5~400kΩ				A1P X34A 1-2Pin
		For heat exchanger	R4T	3.5~360kΩ				A1P X37A 3-4Pin
		For subcooling heat exchanger	R5T	3.5~360kΩ				A1P X37A 5-6Pin

1.2 Indoor Units

Parts Name		Symbol	Model				Remark
			FCQ 24MVJU	FCQ 30MVJU	FCQ 36MVJU	FCQ 42MVJU	
Remote Controller	Wired Remote Controller		BRC1C71				Option
	Wireless Remote Controller		BRC7C812				
Motors	Fan Motor	M1F	1φ45W 6P	1φ90W 6P			
			Thermal Protector 266°F : OFF 176°F : ON				
	Capacitor, fan motor	C1	3.5μF 450VAC	5.0μF 450VAC			
	Drain Pump	M1P	PLD-12230DM Thermal Fuse 293°F				
	Swing Motor	M1S	MP35HCA [3P007482-1]				
Thermistors	Thermistor (Suction Air)	R1T	ST8601A-1 φ4 L250 20kΩ (77°F)				
	Thermistor (for Heat Exchanger High Temp.)	R3T	ST8605-3 φ8 L630 20kΩ (77°F)				
	Thermistor (Heat Exchanger)	R2T	ST8602A-3 φ6 L630 20kΩ (77°F)				
Others	Float Switch	S1L	FS-0211				
	Fuse	F1U	250V 5A φ5.2				
	Transformer	T1R	TR25H25R0				

Parts Name		Symbol	Model				Remark
			FHQ 24MVJU	FHQ 30MVJU	FHQ 36MVJU	FHQ 42MVJU	
Remote Controller	Wired Remote Controller		BRC1C71				Option
	Wireless Controller		BRC7E83				
Motors	Fan Motor	M1F	1φ130W				
			Thermal protector 266°F : OFF 176°F : ON				
	Capacitor for Fan Motor	C1R	9.0μF-450V				
	Swing Motor	M1S	MT8-L[3P058751-1] AC200~240V				
Thermistors	Thermistor (Suction Air)	R1T	ST8601A-1 φ4 L250 20kΩ (77°F)				
	Thermistor (for Heat Exchanger High Temp.)	R3T	ST8605-6 φ8 L = 1250 20kΩ (77°F)		ST8605-6 φ8 L = 1250 20kΩ (77°F)		
	Thermistor (Heat Exchanger)	R2T	ST8602A-6 φ6 L = 1250 20kΩ (77°F)		ST8602A-6 φ6 L = 1250 20kΩ (77°F)		
Others	Fuse	F1U	250V 5A				
	Transformer	T1R	TR25H25R0				

Part 4

Refrigerant Circuit

1. Refrigerant Circuit	16
1.1 RZQ24-30-36-42MVJU	16
2. Functional Parts Layout	18
2.1 RZQ24-30-36-42MVJU	18

1. Refrigerant Circuit

1.1 RZQ24·30·36·42MVJU

No. in refrigerant system diagram	Symbol	Name	Major Function
A	M1C	Inverter compressor (INV)	Inverter compressor is operated on frequencies between 52 Hz and 177 Hz by using the inverter. 17 steps
D	M1F M2F	Inverter fan	Since the system is of air heat exchanging type, the fan is operated at 8-step rotation speed by using the inverter.
E	Y1E	Electronic expansion valve (Main: EV1)	While in heating operation, PI control is applied to keep the outlet superheated degree of air heat exchanger constant.
F	Y2E	Electronic expansion valve (Subcool: EV2)	PI control is applied to keep the outlet superheated degree of subcooling heat exchanger constant.
G	Y1S	Solenoid valve (Hot gas: SVP)	Used to prevent the low pressure from transient falling.
J	Y2S	Solenoid valve (Receiver gas discharging: SVG)	Used to collect refrigerant to receiver.
M	Y3S	Four way valve	Used to switch the operation mode between cooling and heating.
N	S1NPH	High pressure sensor	Used to detect high pressure.
O	S1NPL	Low pressure sensor	Used to detect low pressure.
P	S1PH	HP pressure switch (For INV compressor)	In order to prevent the increase of high pressure when a malfunction occurs, this switch is activated at high pressure of 580 psi or more to stop the compressor operation.
S	—	Fusible plug	In order to prevent the increase of pressure when abnormal heating is caused by fire or others, the fusible part of the plug is molten at a temperature of 158 to 167°F to release the pressure into the atmosphere.
T	—	Pressure regulating valve 1 (Receiver to discharge pipe)	This valve opens at a pressure of 290 to 390 psi for prevention of pressure increase, thus resulting in no damage of functional parts due to the increase of pressure in transportation or storage.
1	R1T	Thermistor (Outdoor air: Ta)	Used to detect outdoor temperature, correct discharge pipe temperature, and others.
2	R2T	Thermistor (Suction pipe: Ts)	used to detect suction pipe temperature, keep the suction superheated degree constant in heating operation, and others.
3	R3T	Thermistor (INV discharge pipe: Tdi)	used to detect discharge pipe temperature, make the temperature protection control of compressor, and others.
4	R4T	Thermistor (Heat exchanger deicer: Tb)	Used to detect liquid pipe temperature of air heat exchanger, determine defrosting operation, and others.
5	R5T	Thermistor (Subcooling heat exchanger gas pipe: Tsh)	Used to detect gas pipe temperature on the evaporation side of subcooling heat exchanger, keep the superheated degree at the outlet of subcooling heat exchanger constant, and others.

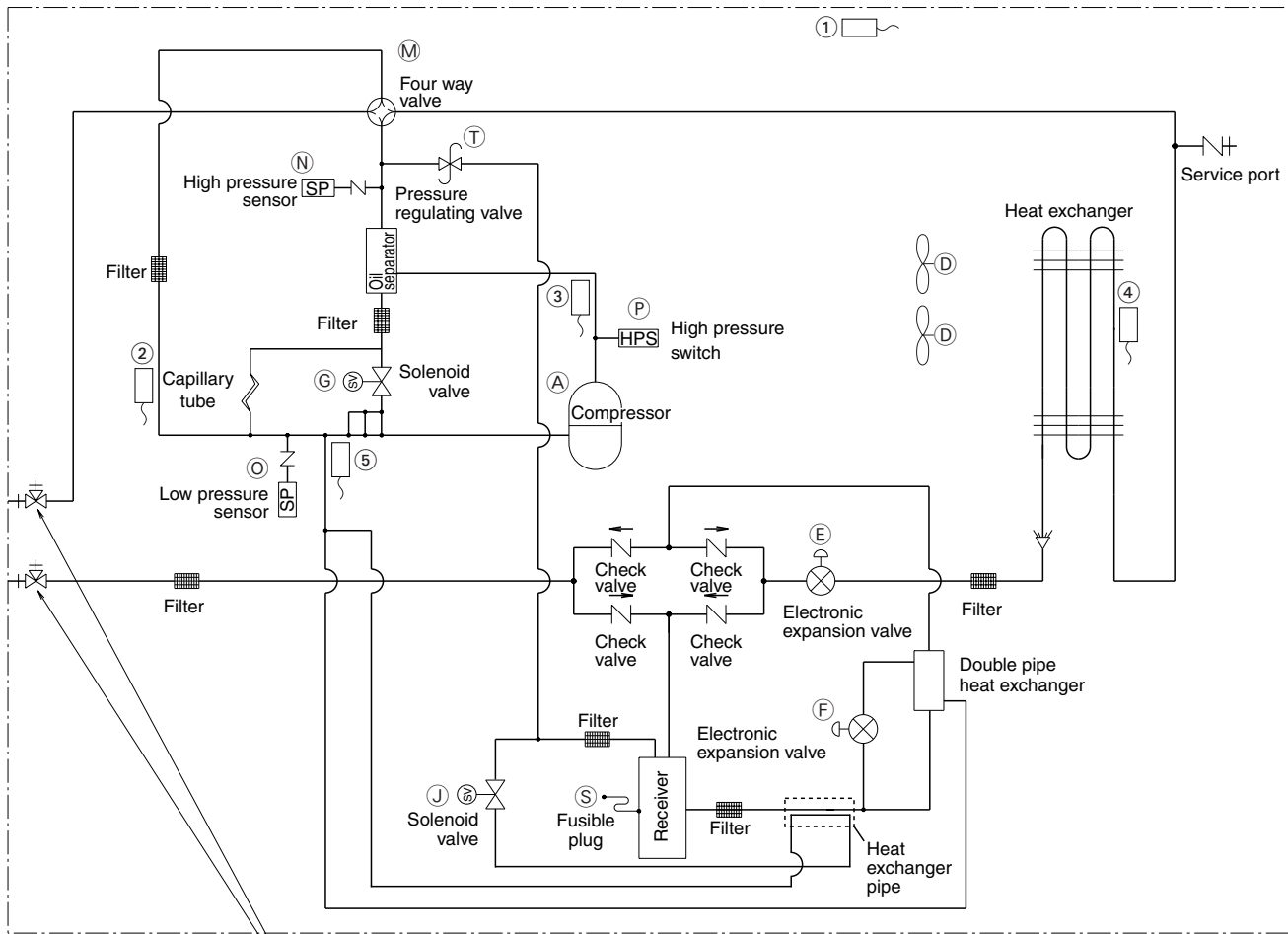

Stop valve (With service port on field piping side ϕ 6.4mm flare connection)

C : 3D047385

2. Functional Parts Layout

2.1 RZQ24-30-36-42MVJU

Birds-eye view

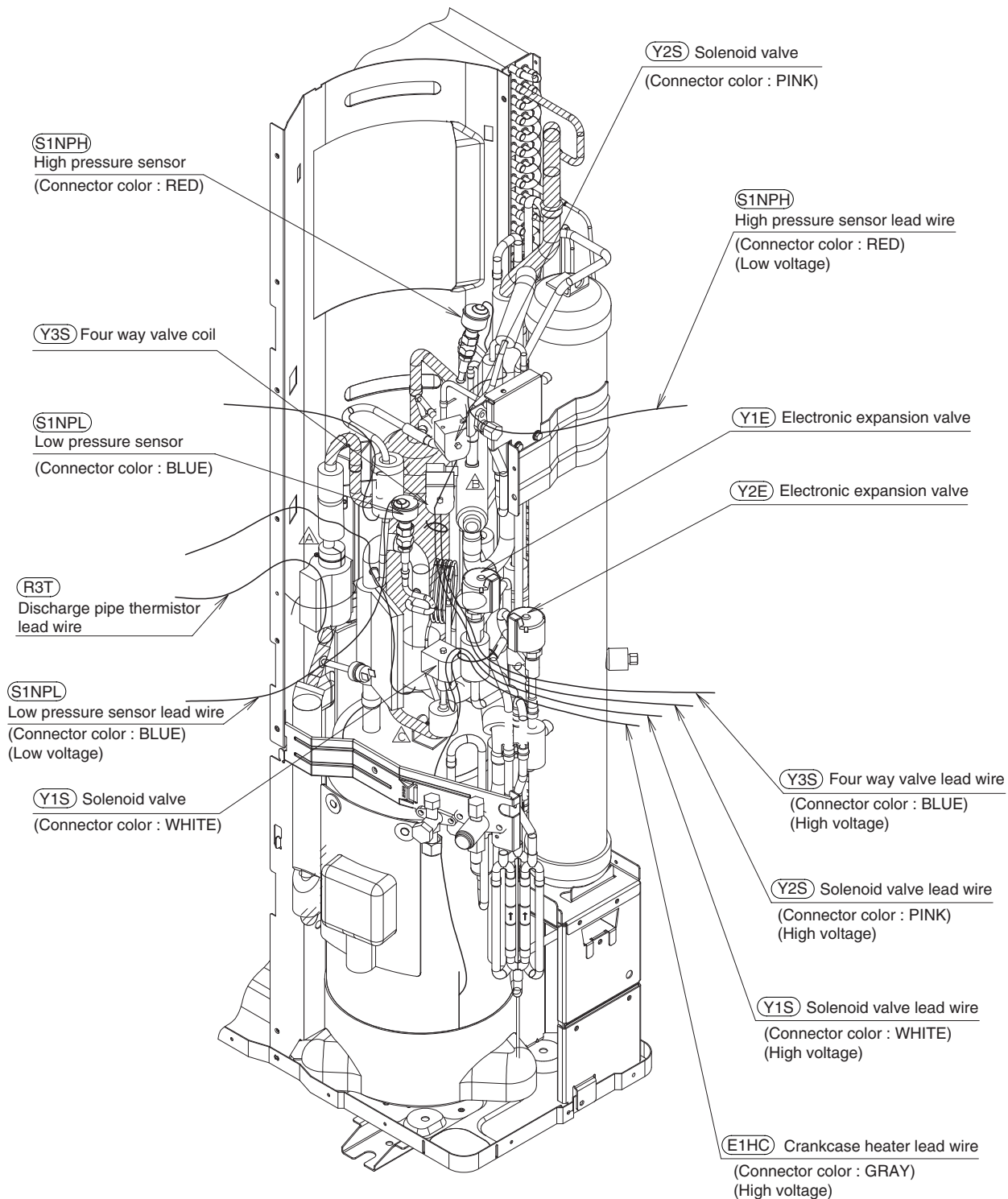

1P152123H

Part 5

Function

1. Operation Mode	20
2. Basic Control.....	21
2.1 Normal Operation.....	21
2.2 Compressor PI Control	22
2.3 Electronic Expansion Valve PI Control	23
2.4 Cooling Operation Fan Control	24
3. Special Control.....	25
3.1 Startup Control.....	25
3.2 Oil Return Operation	26
3.3 Defrosting Operation.....	28
3.4 Pump-down Residual Operation	29
3.5 Restart Standby	30
3.6 Stopping Operation	31
3.7 Pressure Equalization Prior to Startup.....	32
4. Protection Control	33
4.1 High Pressure Protection Control	33
4.2 Low Pressure Protection Control	34
4.3 Discharge Pipe Protection Control	35
4.4 Inverter Protection Control	36
5. Other Control	37
5.1 Heating Operation Prohibition	37
6. Outline of Control (Indoor Unit)	38
6.1 Drain Pump Control	38
6.2 Louver Control for Preventing Ceiling Dirt	40
6.3 Thermostat Sensor in Remote Controller	41
6.4 Freeze Prevention.....	43
6.5 View of Operations of Swing Flaps	44

1. Operation Mode

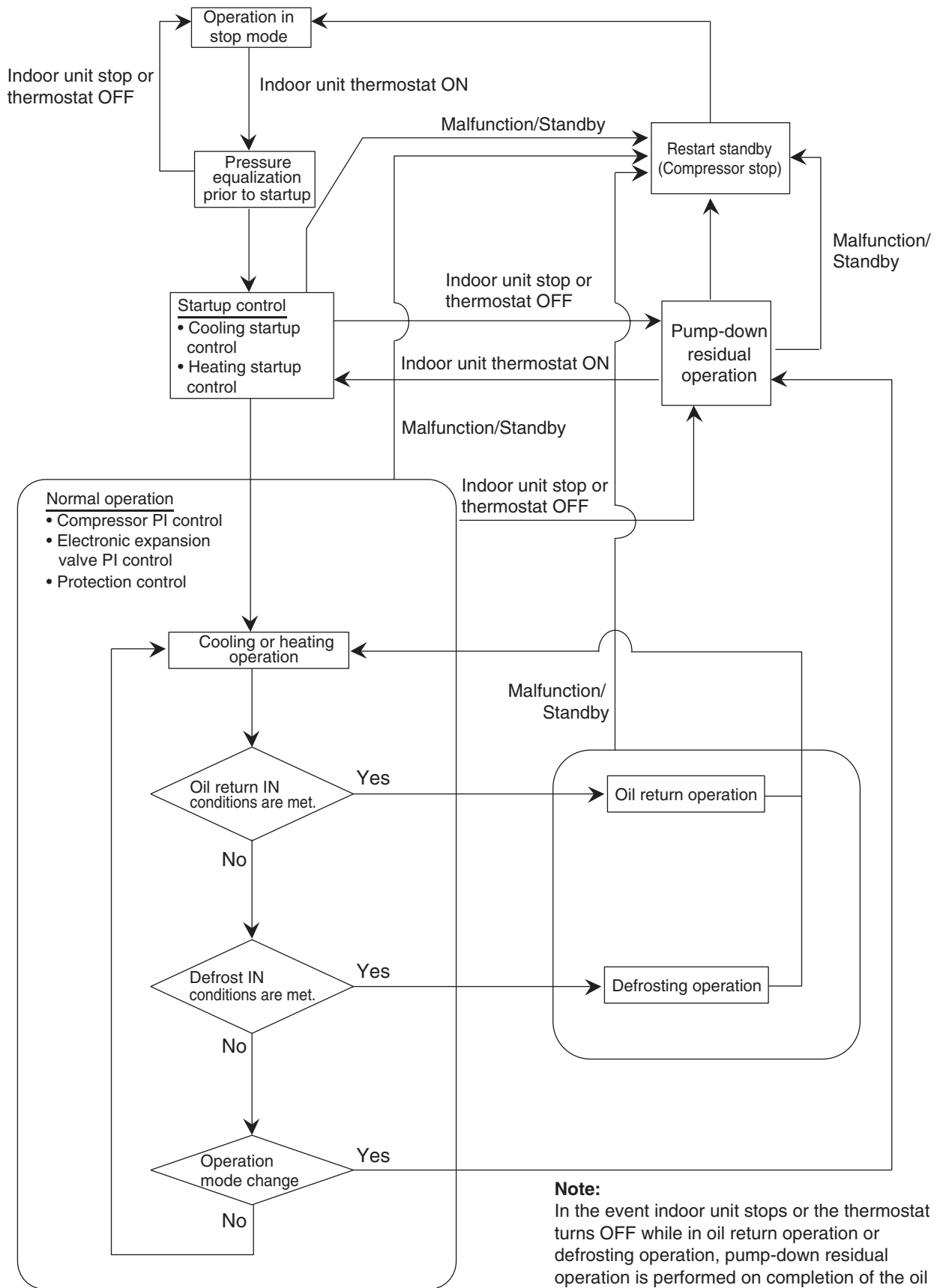

(V3152)

2. Basic Control

2.1 Normal Operation

■ Cooling Operation

Actuator	Operation	Remarks
Compressor	Compressor PI control	Used for high pressure protection control, low pressure protection control, discharge pipe temperature protection control, and compressor operating frequency upper limit control with inverter protection control.
Outdoor unit fan	Cooling fan control	—
Four way valve	OFF	—
Main electronic expansion valve (EV1)	1400 pls	—
Subcooling electronic expansion valve (EV2)	PI control	—
Hot gas bypass valve (SVP)	OFF	This valve turns on with low pressure protection control.
Receiver gas discharging valve (SVG)	OFF	—

■ Heating Operation

Actuator	Operation	Remarks
Compressor	Compressor PI control	Used for high pressure protection control, low pressure protection control, discharge pipe temperature protection control, and compressor operating frequency upper limit control with inverter protection control.
Outdoor unit fan	STEP8	The fan step changes to STEP1 with high pressure > 454 psi.
Four way valve	ON	—
Main electronic expansion valve (EV1)	PI control	—
Subcooling electronic expansion valve (EV2)	0 pls	—
Hot gas bypass valve (SVP)	OFF	This valve turns on with low pressure protection control.
Receiver gas discharging valve (SVG)	OFF	—

* Heating operation is not functional at an outdoor air temperature of 86°FDB or more.

2.2 Compressor PI Control

Compressor PI Control

Carries out the compressor capacity PI control to maintain Te at constant during cooling operation and Tc at constant during heating operation to ensure stable unit performance.

[Cooling operation]

Controls compressor capacity to adjust Te to achieve target value (TeS).

Te : Low pressure equivalent saturation temperature (°F)

Te setting (Set in Set-up mode 2)

L	M (Normal) (factory setting)	H
37.5	43	48

TeS : Target Te value
(Varies depending on Te setting, operating frequency, etc.)

[Heating operation]

Controls compressor capacity to adjust Tc to achieve target value (TcS).

Tc : High pressure equivalent saturation temperature (°F)

Tc setting

L	M (Normal) (factory setting)	H
109.5	115	120

TcS : Target Tc value
(Varies depending on Tc setting, operating frequency, etc.)

RZQ24 · 30 · 36 · 42M

STEP	INV
1	52Hz
2	57Hz
3	62Hz
4	68Hz
5	74Hz
6	81Hz
7	88Hz
8	96Hz
9	104Hz
10	110Hz
11	116Hz
12	124Hz
13	133Hz
14	143Hz
15	158Hz
16	165Hz
17	177Hz

* Compressors may operate in a pattern other than those listed in above tables subject to the operating conditions.

2.3 Electronic Expansion Valve PI Control

Main Electronic Expansion Valve EV1 Control

Carries out the electronic expansion valve (Y1E) PI control to maintain the evaporator outlet superheated degree (SH) at constant during heating operation to make maximum use of the outdoor unit heat exchanger (evaporator).

$$SH = T_s - T_e$$

SH : Evaporator outlet superheated degree (°F)

T_s : Suction pipe temperature detected by thermistor R2T (°F)

T_e : Low pressure equivalent saturation temperature (°F)

The optimum initial value of the evaporator outlet superheated degree is 5°C, but varies depending on the discharge pipe superheated degree of inverter compressor.

Subcooling Electronic Expansion Valve EV2 Control

Makes PI control of the electronic expansion valve (Y2E) to keep the superheated degree (SH) of the outlet gas pipe on the evaporator side for the full use of the subcooling heat exchanger.

$$SH = T_{sh} - T_e$$

SH : Outlet superheated degree of evaporator (°F)

T_{sh} : Suction pipe temperature detected with the thermistor R5T (°F)

T_e : Low pressure equivalent saturation temperature (°F)

2.4 Cooling Operation Fan Control

In cooling operation with low outdoor air temperature, this control is used to provide the adequate amount of circulation air with liquid pressure secured by high pressure control using outdoor unit fan.

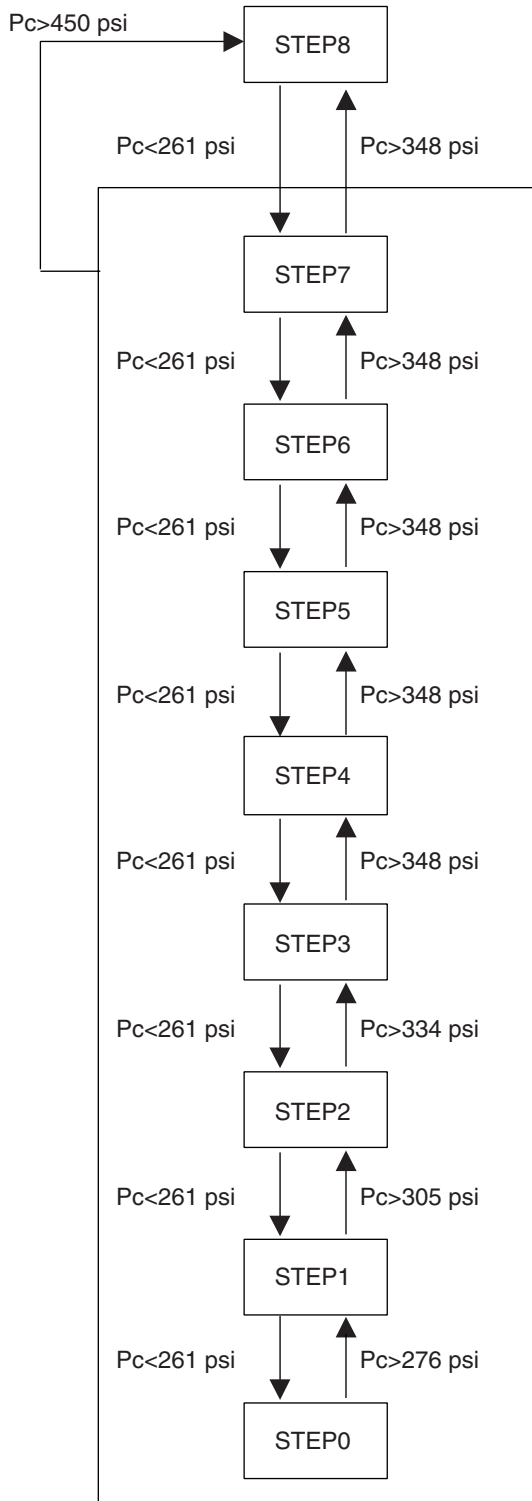

Pc: HP pressure sensor detection value

Fan Steps

Cooling	M1F	M2F
STEP0	0 rpm	0 rpm
STEP1	250 rpm	0 rpm
STEP2	400 rpm	0 rpm
STEP3	285 rpm	250 rpm
STEP4	360 rpm	325 rpm
STEP5	445 rpm	410 rpm
STEP6	580 rpm	545 rpm
STEP7	715 rpm	680 rpm
STEP8	850 rpm	815 rpm

Reference

Heating	M1F	M2F
STEP1	250rpm	0 rpm
STEP8	850 rpm	815rpm

There are 2 steps in heating operation.

(V3172)

3. Special Control

3.1 Startup Control

On activation, following control is performed to lighten load of the compressor by back liquid and the like. Also, the position of the four way valve is defined.

3.1.1 Startup Control in Cooling Operation

Actuator	Operation	Remarks
Compressor	Differential pressure control	Compressor operating frequency increases by 2 step / 20 sec. until $P_c - P_e > 58$ psi.
Outdoor unit fan	High pressure control	Initial fan speed is set to STEP 0. 1-step increase with $P_c > 305$ psi 1-step decrease with $P_c < 261$ psi
Four way valve	OFF	—
Main electronic expansion valve (EV1)	1400 pls	—
Subcooling electronic expansion valve (EV2)	0 pls	—
Hot gas bypass valve (SVP)	ON	—
Receiver gas discharging valve (SVG)	OFF	—
Ending conditions	or $\left[\begin{array}{l} \bullet 230 \text{ sec.} \\ \bullet P_c - P_e > 58 \text{ psi} \\ \bullet 45 \text{ sec.} \end{array} \right.$	

3.1.2 Startup Control in Heating Operation

Actuator	Operation	Remarks
Compressor	Differential pressure control	Compressor operating frequency increases by 2 step / 20 sec. until $P_c - P_e > 58$ psi
Outdoor unit fan	STEP8	—
Four way valve	ON	—
Main electronic expansion valve (EV1)	180 pls	—
Subcooling electronic expansion valve (EV2)	0 pls	—
Hot gas bypass valve (SVP)	ON	—
Receiver gas discharging valve (SVG)	OFF	—
Ending conditions	or $\left[\begin{array}{l} \bullet 145 \text{ sec.} \\ \bullet P_c - P_e > 58 \text{ psi} \\ \bullet 15 \text{ sec.} \end{array} \right.$	

3.2 Oil Return Operation

Oil flown from the compressor to the side of system is collected by oil-returning operation, in case of that oil in the compressor runs down.

3.2.1 Oil Return Operation in Cooling Operation

[Conditions to start]

The cooling oil-returning operation is started referring following conditions.

- Integrated amount of displaced oil
- Timer

(After the power is turned on, integrated operating-time is 2 hours and subsequently every 8 hours.)

In addition, integrated amount of displaced oil is derived from Tc, Te, and the compressor load.

Outdoor unit actuator	Oil return preparation operation	Oil return operation	Post-oil-return operation
Compressor	Upper limit control	124 Hz	124 Hz
Outdoor unit fan	Fan control	Fan control	Fan control
Four way valve	OFF	OFF	OFF
Main electronic expansion valve (EV1)	1400 pls	1400 pls	1400 pls
Subcooling electronic expansion valve (EV2)	SH control	0 pls	0 pls
Hot gas bypass valve (SVP)	OFF	ON	ON
Receiver gas discharging valve (SVG)	OFF	OFF	OFF
Ending conditions	20 sec.	or { <ul style="list-style-type: none"> • 6 min. • $T_s - T_e < 5$ 	3 min.

Indoor unit actuator		Cooling oil return operation
Fan	Thermostat ON unit	Set Air Volume
	Stopping unit	OFF
	Thermostat OFF unit	OFF
Electronic expansion valve	Thermostat ON unit	Normal opening
	Stopping unit	200 pls
	Thermostat OFF unit	200 pls

3.2.2 Oil Return Operation in Heating Operation

[Conditions to start]

The heating oil-returning operation is started referring following conditions.

- Integrated amount of displaced oil
- Timer

(After the power is turned on, integrated operating-time is 2 hours and subsequently every 8 hours.)

In addition, integrated amount of displaced oil is derived from Tc, Te, and the compressor load.

Outdoor Unit Actuator	Oil return preparation operation	Oil return operation	Post-oil-return operation
Compressor	Upper limit control	124 Hz	2-step increase from 52 Hz to (Pc - Pe>58 psi) time
Outdoor unit fan	STEP8	OFF	STEP8
Four way valve	ON	OFF	ON
Main electronic expansion valve (EV1)	SH control	1400 pls	200~400 pls
Subcooling electronic expansion valve (EV2)	0 pls	0 pls	0 pls
Hot gas bypass valve (SVP)	OFF	ON	ON
Receiver gas discharging valve (SVG)	ON	ON	OFF
Ending conditions	130 sec.	or [<ul style="list-style-type: none"> • 6 min. • Ts - Te<5 	or [<ul style="list-style-type: none"> • 160 sec. • Pc - Pe>58 psi

* From the preparing oil-returning operation to the oil-returning operation, and from the oil-returning operation to the operation after oil-returning, the compressor stops for 1 minute to reduce noise on changing of the four way valve.

Indoor unit actuator		Heating oil return operation
Fan	Thermostat ON unit	OFF
	Stopping unit	OFF
	Thermostat OFF unit	OFF
Electronic expansion valve	Thermostat ON unit	500 pls
	Stopping unit	500 pls
	Thermostat OFF unit	500 pls

3.3 Defrosting Operation

The defrost operation is performed to solve frost on the outdoor unit heat exchanger when heating, and the heating capacity is recovered.

[Conditions to start]

The defrost operation is started referring following conditions.

- Outdoor heat exchanger heat transfer co-efficiency
- Temperature of heat-exchange (Tb)
- Timer (2 hours at the minimum)

In addition, outdoor heat-exchange co-efficiency is derived from Tc, Te, and the compressor load.

Outdoor unit actuator	Defrost preparation operation	Defrost operation	Post Defrost operation
Compressor	52 Hz	177 Hz	2-step increase from 52 Hz to (Pc - Pe>58 psi) every 20 sec.
Outdoor unit fan	STEP8	OFF	STEP8
Four way valve	ON	OFF	ON
Main electronic expansion valve (EV1)	SH control	1400 pls	200~400 pls
Subcooling electronic expansion valve (EV2)	0 pls	0 pls	0 pls
Hot gas bypass valve (SVP)	OFF	ON	ON
Receiver gas discharging valve (SVG)	ON	ON	OFF
Ending conditions	130 sec.	or [<ul style="list-style-type: none"> • 15 min. • Tb >51.8°F 	or [<ul style="list-style-type: none"> • 160 sec. • Pc - Pe>58 psi

* From the preparing operation to the defrost operation, and from the defrost operation to the operation after defrost, the compressor stops for 1 minute to reduce noise on changing of the four way valve.

Indoor unit actuator		During defrost
Fan	Thermostat ON unit	OFF
	Stopping unit	OFF
	Thermostat OFF unit	OFF
Electronic expansion valve	Thermostat ON unit	500 pls
	Stopping unit	500 pls
	Thermostat OFF unit	500 pls

3.4 Pump-down Residual Operation

When activating compressor, if the liquid refrigerant remains in the heat-exchanger, the liquid enters into the compressor and dilutes oil therein resulting in decrease of lubricity.

Therefore, the pump-down residual operation is performed to collect the refrigerant in the heat-exchanger when the compressor is down.

3.4.1 Pump-down Residual Operation in Cooling Operation

Actuator	Master unit operation
Compressor	124 Hz
Outdoor unit fan	Fan control
Four way valve	OFF
Main electronic expansion valve (EV1)	2000 pls
Subcooling electronic expansion valve (EV2)	0 pls
Hot gas bypass valve (SVP)	OFF
Receiver gas discharging valve (SVG)	ON → OFF
Ending conditions	or <ul style="list-style-type: none"> • 30 sec. • Pe < 73 psi • Td > 230°F

3.4.2 Pump-down Residual Operation in Heating Operation

Actuator	Master unit operation
Compressor	124 Hz
Outdoor unit fan	STEP8
Four way valve	ON
Main electronic expansion valve (EV1)	0 pls
Subcooling electronic expansion valve (EV2)	0 pls
Hot gas bypass valve (SVP)	OFF
Receiver gas discharging valve (SVG)	ON → OFF
Ending conditions	or <ul style="list-style-type: none"> • 3 min. • Pe < 36 psi • Td > 230°F

3.5 Restart Standby

Restart is stood by force to prevent frequent power-on/off and to equalize pressure in the refrigerant system.

Actuator	Operation	Remarks
Compressor	OFF	—
Outdoor unit fan	Ta>86°F: STEP4 Ta≤86°F: OFF	—
Four way valve	Keep former condition.	—
Main electronic expansion valve (EV1)	0 pls	—
Subcooling electronic expansion valve (EV2)	0 pls	—
Hot gas bypass valve (SVP)	ON	—
Receiver gas discharging valve (SVG)	OFF	—
Ending conditions	5 min.	—

3.6 Stopping Operation

Operation of the actuator when the system is down, is cleared up.

3.6.1 When System is in Stop Mode

Actuator	Operation
Compressor	OFF
Outdoor unit fan	OFF
Four way valve	Keep former condition.
Main electronic expansion valve (EV1)	0 pls
Subcooling electronic expansion valve (EV2)	0 pls
Hot gas bypass valve (SVP)	OFF
Receiver gas discharging valve (SVG)	OFF
Ending conditions	Indoor unit thermostat is turned ON.

3.7 Pressure Equalization Prior to Startup

Before activating the compressor, the activation load is lightened by equalization across the compressor. In addition, inverters turn on electricity and capacitors are charged.

Actuator	Operation	Remarks
Compressor	OFF	—
Outdoor unit fan	Cooling:OFF Heating:Ta>78.8°F; STEP8, Ta≤78.8°F; OFF	—
Four way valve	Keep former condition.	—
Main electronic expansion valve (EV1)	0 pls	—
Subcooling electronic expansion valve (EV2)	0 pls	—
Hot gas bypass valve (SVP)	ON	—
Receiver gas discharging valve (SVG)	OFF	—
Ending conditions	or [<ul style="list-style-type: none"> • 3 min. • Pc-Pe<29 psi 	—

4. Protection Control

4.1 High Pressure Protection Control

This high pressure protection control is used to prevent the activation of protection devices due to abnormal increase of high pressure and to protect compressors against the transient increase of high pressure.

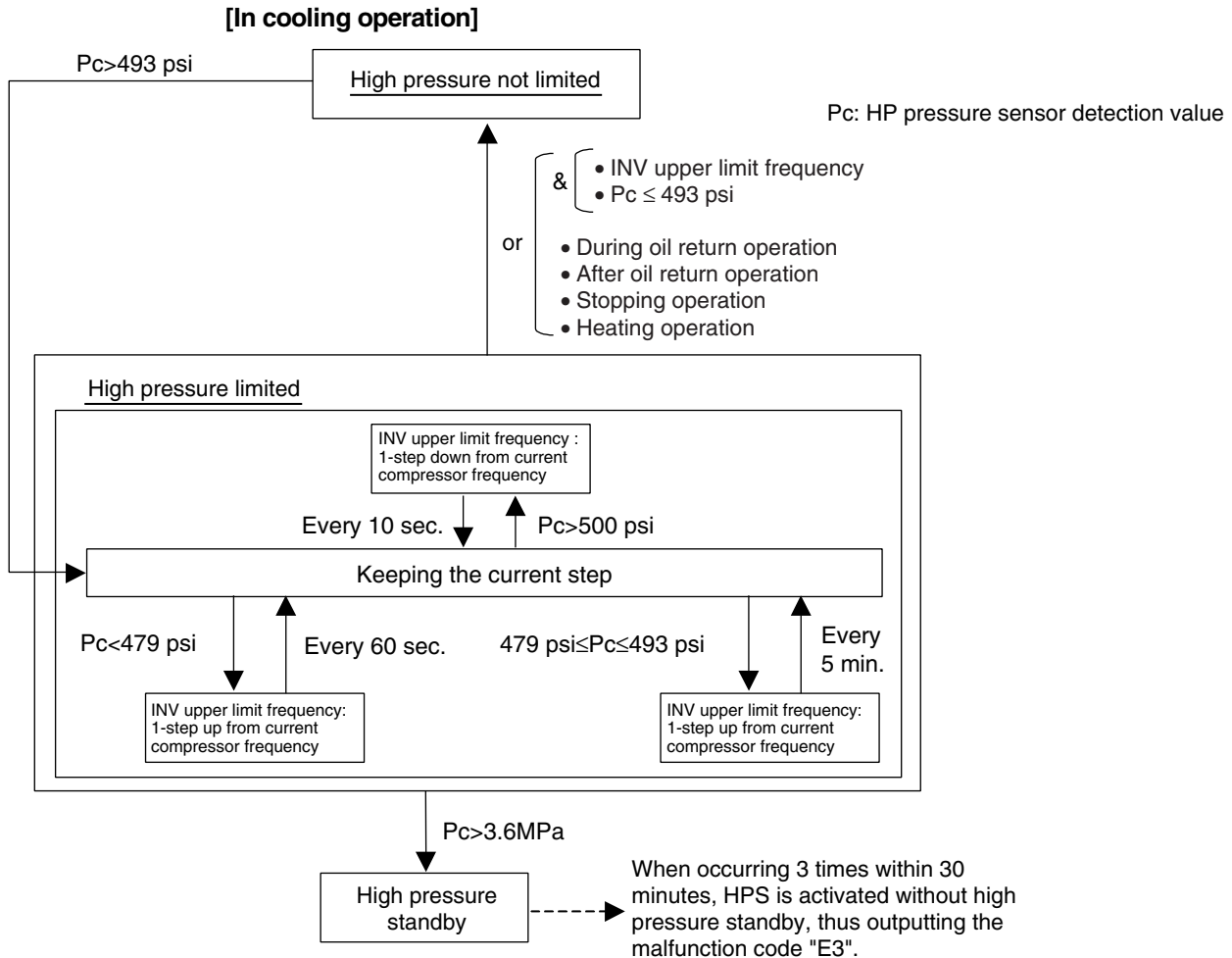

(V3173)

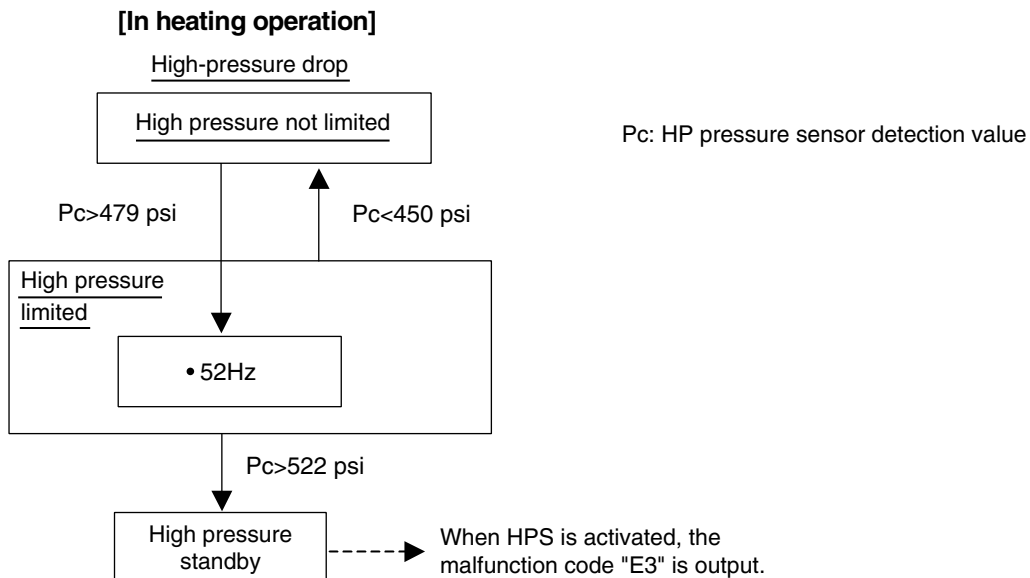

(V3174)

4.2 Low Pressure Protection Control

This low pressure protection control is used to protect compressors against the transient decrease of low pressure.

[In cooling operation]

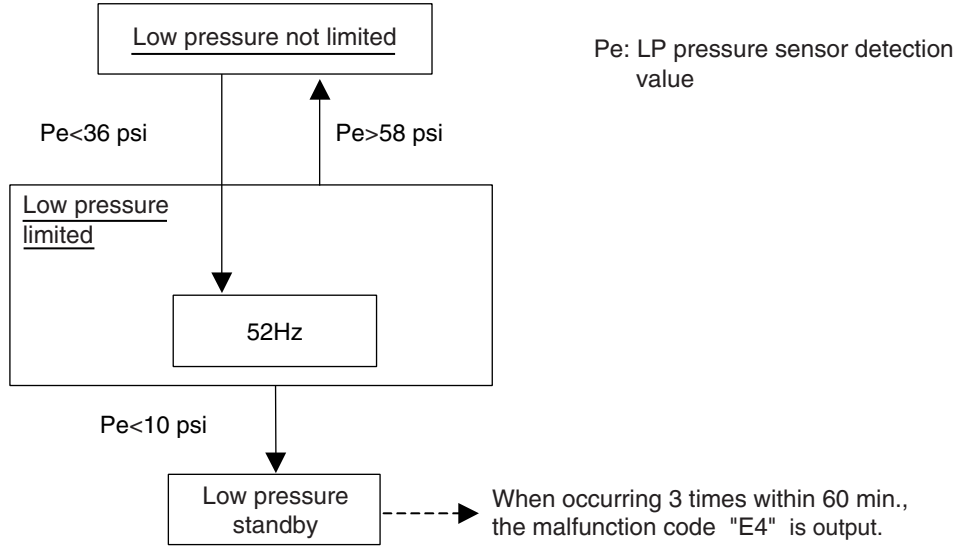

(V3175)

[In heating operation]

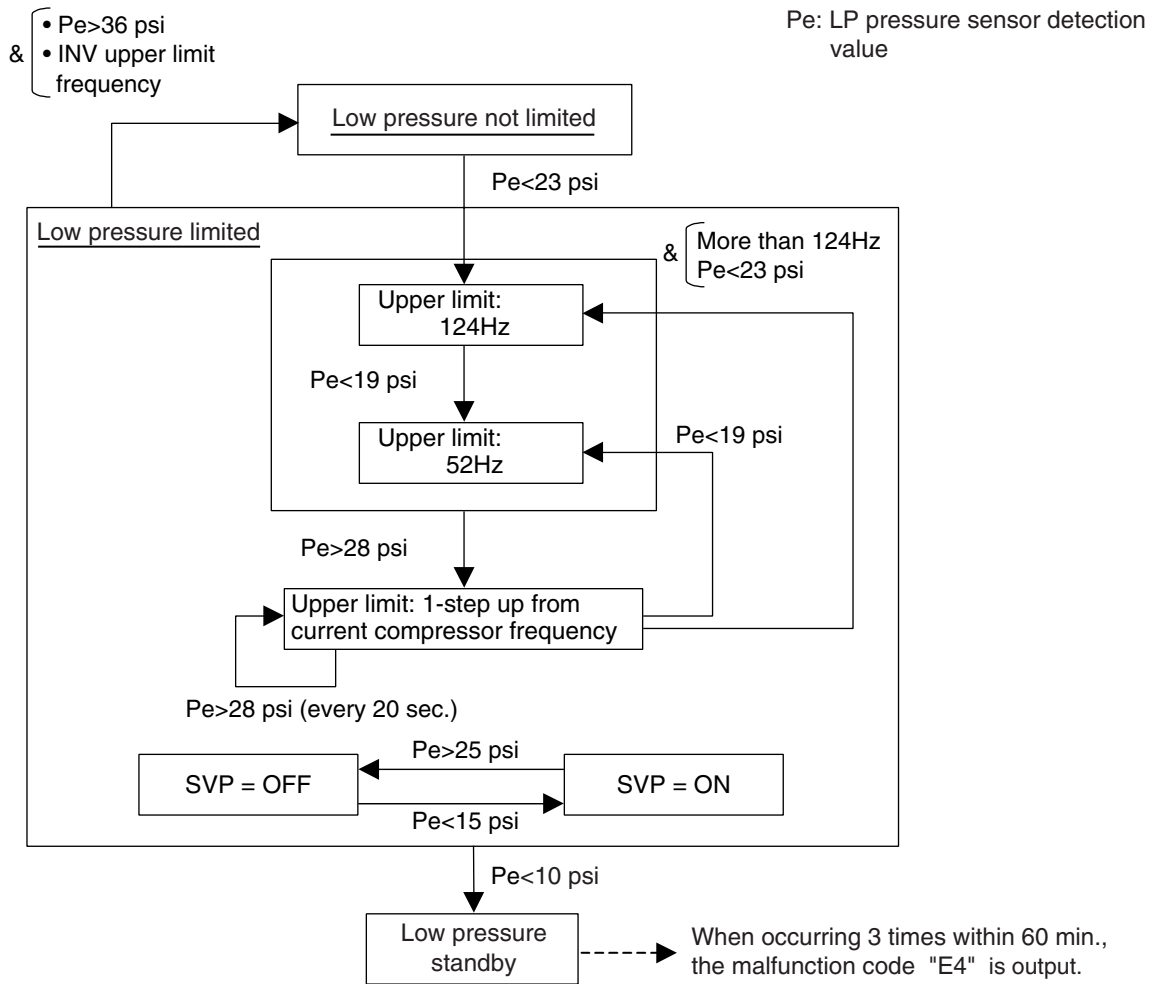

(V3176)

4.3 Discharge Pipe Protection Control

This discharge pipe protection control is used to protect the compressor internal temperature against a malfunction or transient increase of discharge pipe temperature.

[INV compressor]

HTdi : Value of INV compressor discharge pipe temperature (Tdi) compensated with outdoor air temperature
 Tp : Value of compressor port temperature calculated by Tc and Te, and suction superheated degree.

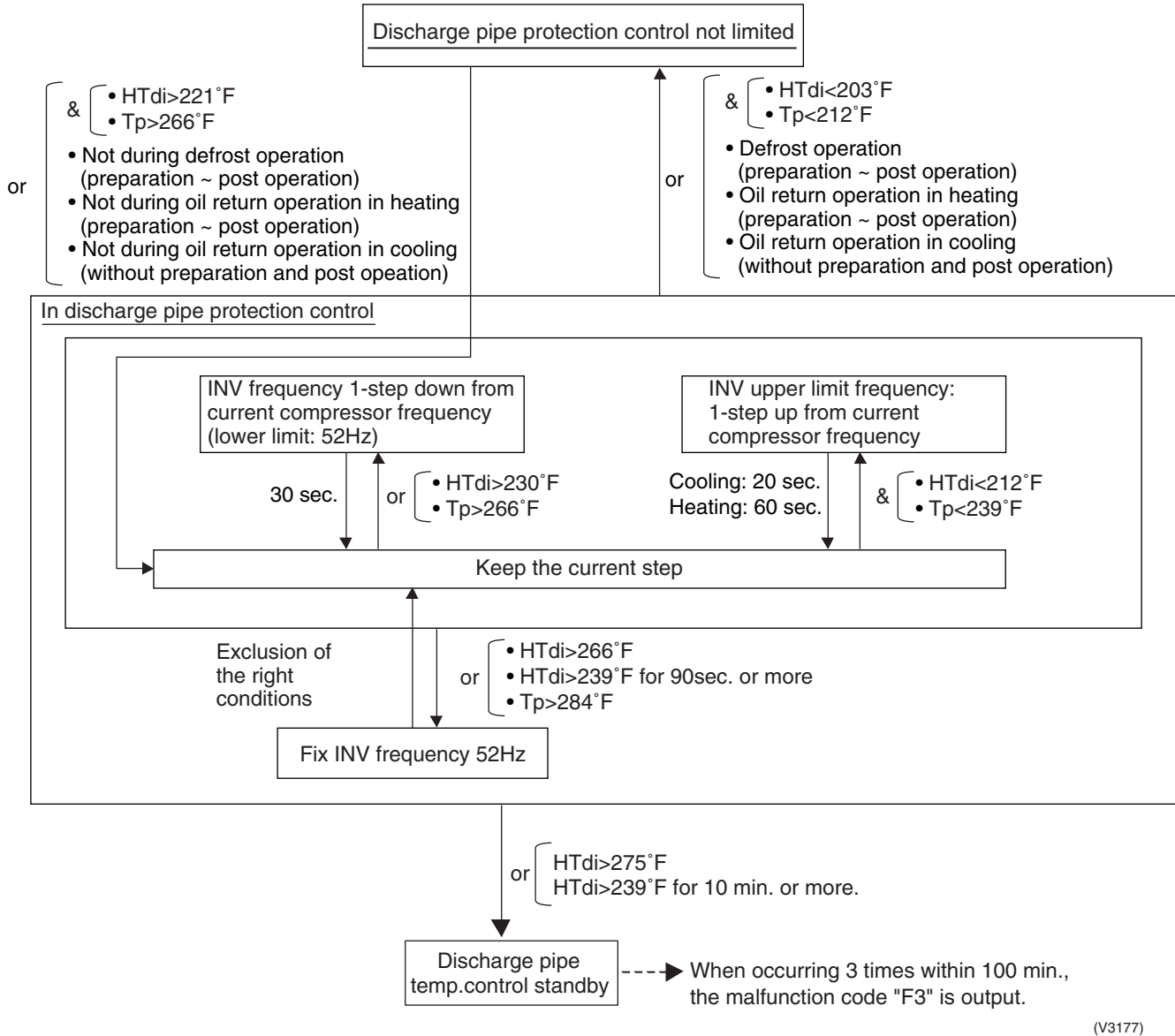

(V3177)

4.4 Inverter Protection Control

Inverter current protection control and inverter fin temperature control are performed to prevent tripping due to a malfunction, or transient inverter overcurrent, and fin temperature increase.

[Inverter overcurrent protection control]

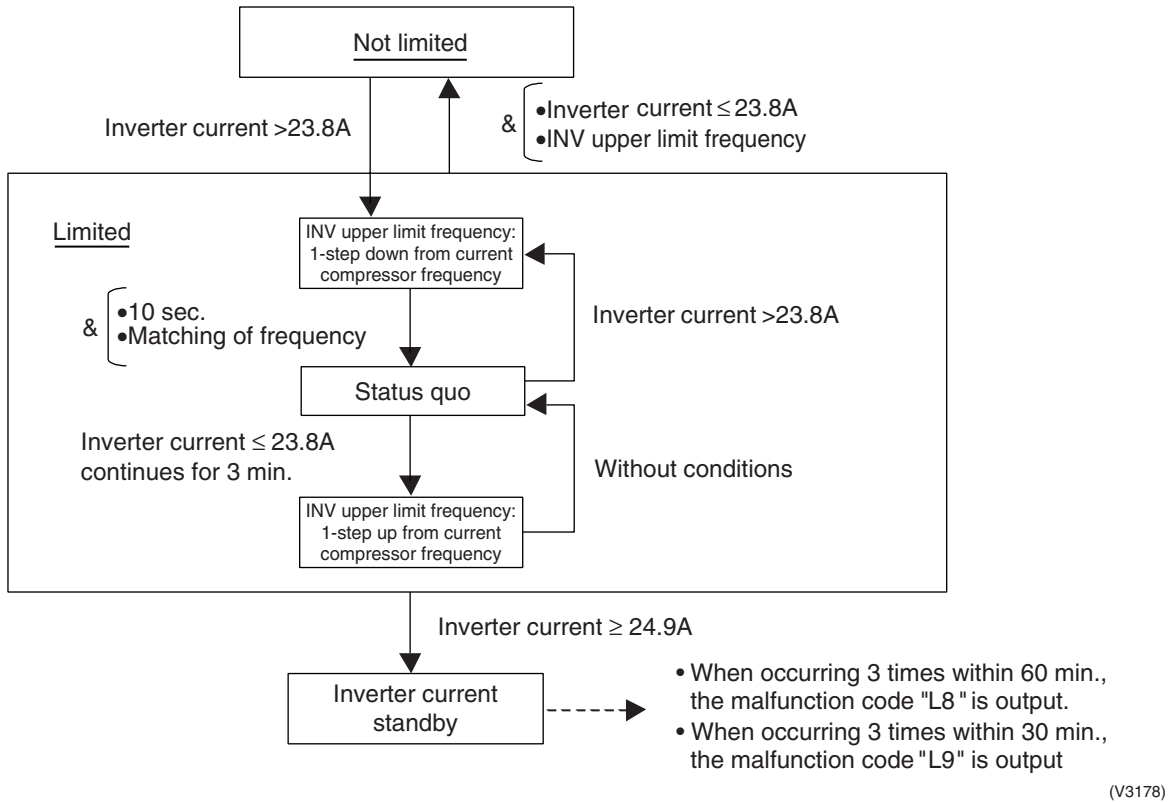

[Inverter fin temperature control]

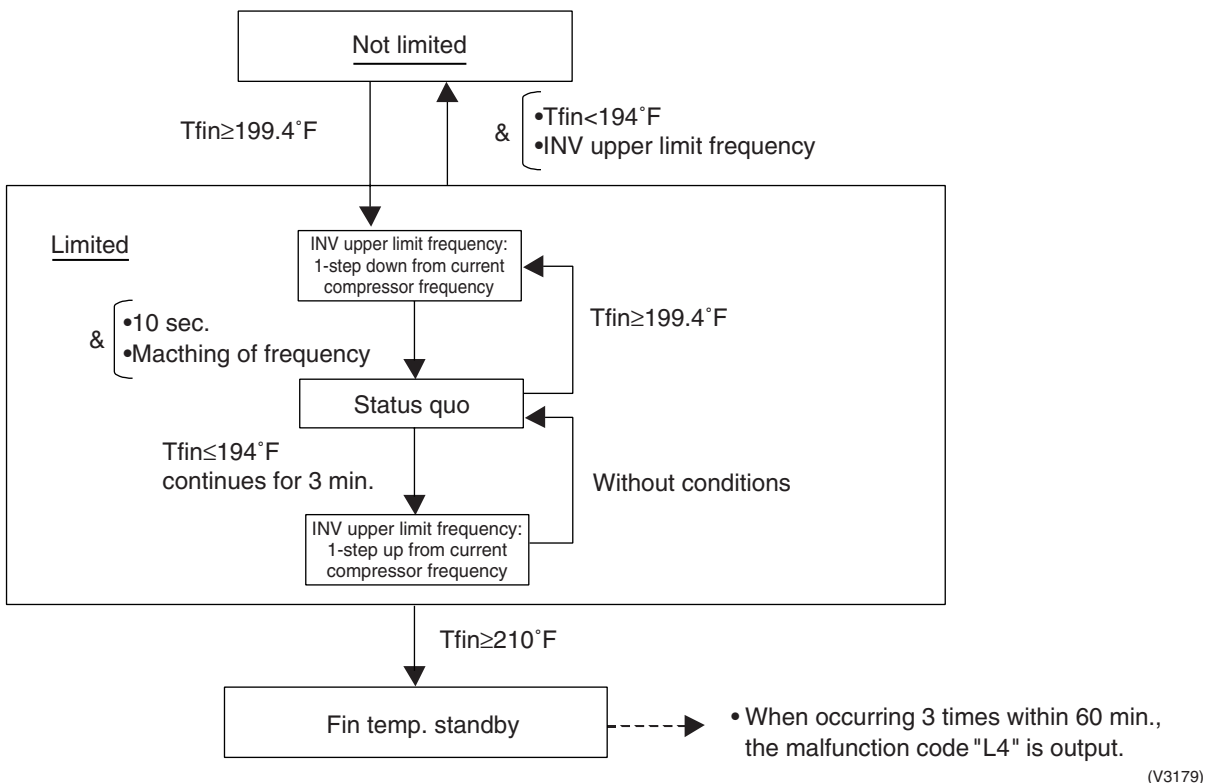

5. Other Control

5.1 Heating Operation Prohibition

Heating operation is prohibited above 86°FDB outdoor air temperature.

6. Outline of Control (Indoor Unit)

6.1 Drain Pump Control

1. The drain pump is controlled by the ON/OFF buttons (4 button (1) - (4) given in the figure below).

6.1.1 When the Float Switch is Tripped While the Cooling Thermostat is ON:

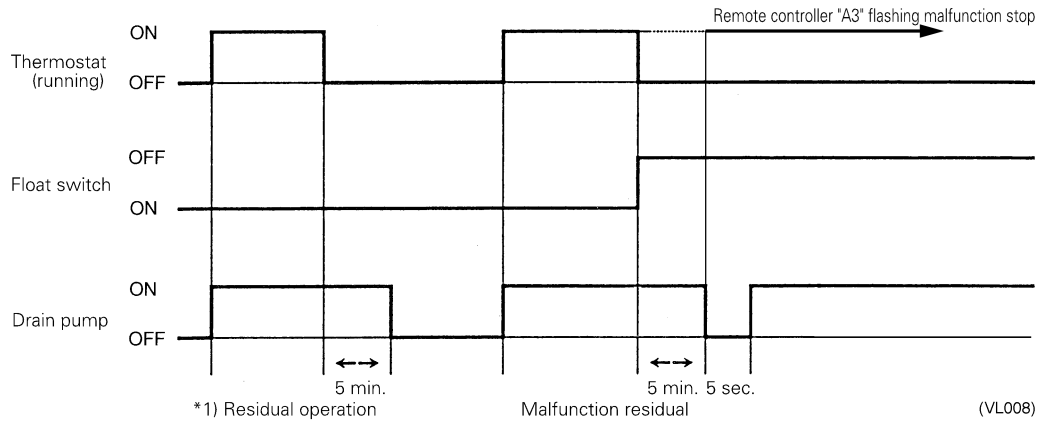

* 1. The objective of residual operation is to completely drain any moisture adhering to the fin of the indoor unit heat exchanger when the thermostat goes off during cooling operation.

6.1.2 When the Float Switch is Tripped While the Cooling Thermostat is OFF:

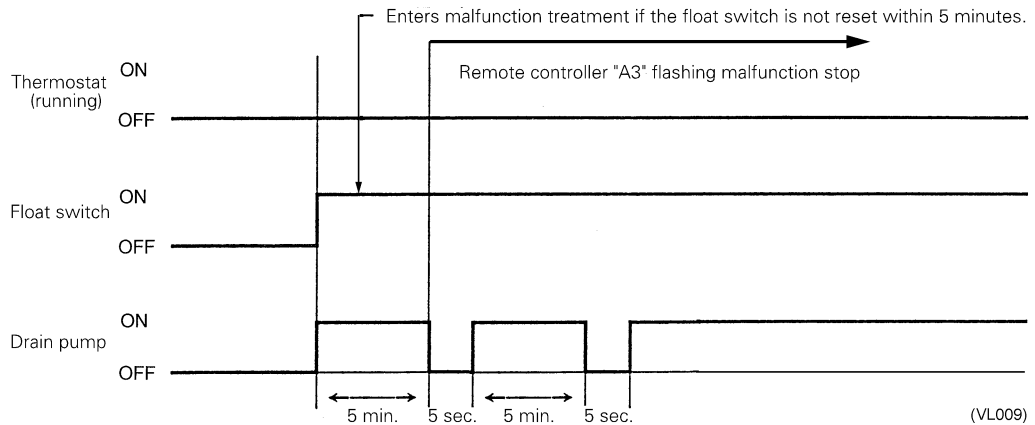

6.1.3 When the Float Switch is Tripped During Heating Operation:

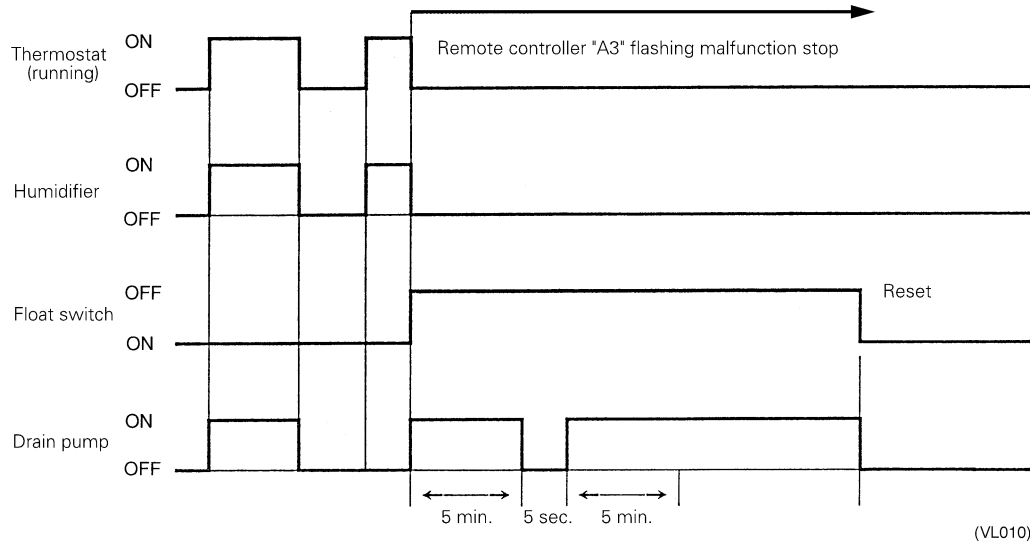

During heating operation, if the float switch is not reset even after the 5 minutes operation, 5 seconds stop, 5 minutes operation cycle ends, operation continues until the switch is reset.

6.1.4 When the Float Switch is Tripped and “AF” is Displayed on the Remote Controller:

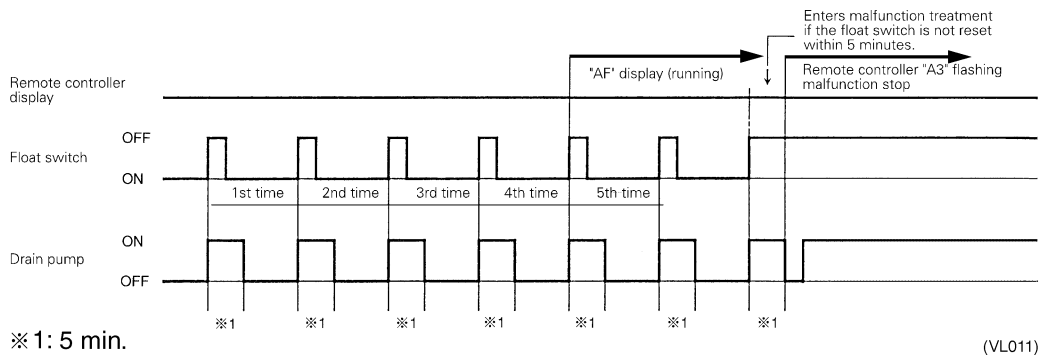

Note:

If the float switch is tripped five times in succession, a drain malfunction is determined to have occurred. “AF” is then displayed as operation continues.

6.2 Louver Control for Preventing Ceiling Dirt

We have added a control feature that allows you to select the range of in which air direction can be adjusted in order to prevent the ceiling surrounding the air discharge outlet of ceiling mounted cassette type units from being soiled.

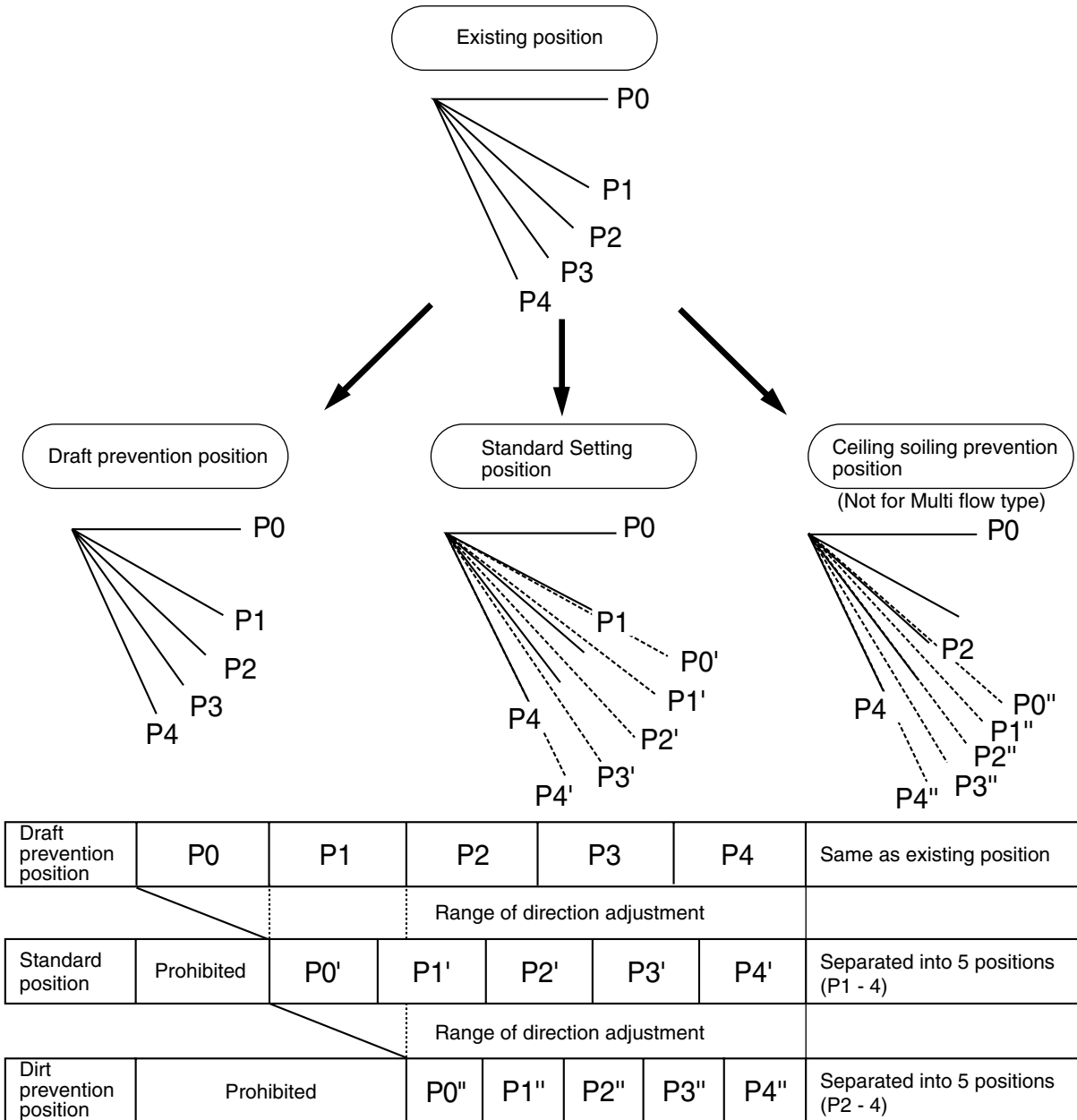

(VL012)

The factory set position is standard position.

6.3 Thermostat Sensor in Remote Controller

Temperature is controlled by both the thermostat sensor in remote controller and air suction thermostat in the indoor unit. (This is however limited to when the field setting for the thermostat sensor in remote controller is set to "Use.")



Note: When OA (outdoor air) is introduced to the air-conditioner with mixed into indoor air, the room temperature may fail to be preset temperature, since TS and TH1 do not enter the area of "use range of remote control thermostat." In such a case, put the remote sensor (optional accessory) in your room, and use it with setting "do not use remote control thermostat."

Cooling

If there is a significant difference in the preset temperature and the suction temperature, fine adjustment control is carried out using a body thermostat sensor, or using the sensor in the remote controller near the position of the user when the suction temperature is near the preset temperature.

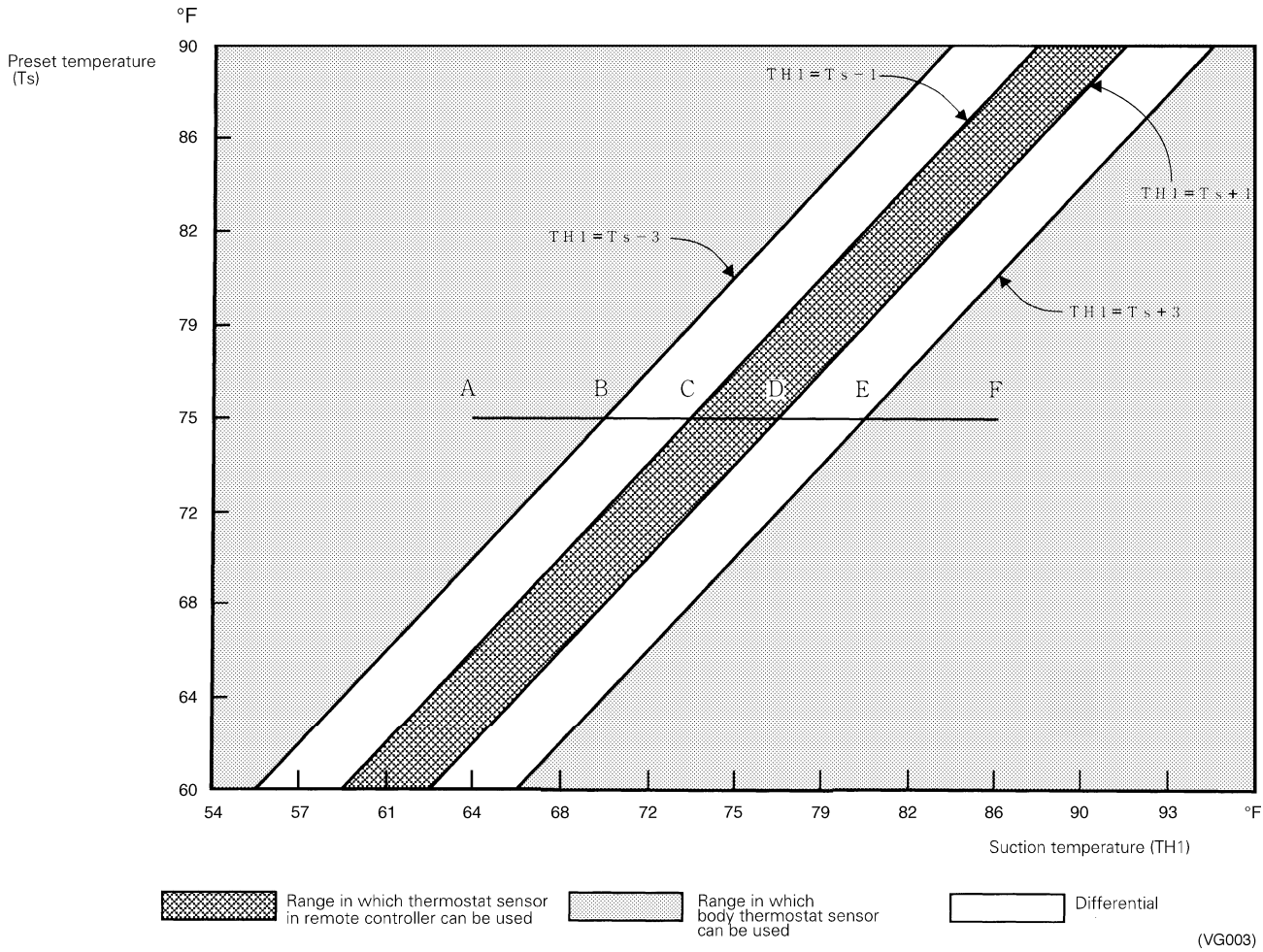

■ Ex: When cooling

Assuming the preset temperature in the figure above is 75°F, and the suction temperature has changed from 64°F to 86°F (A → F):

(This example also assumes there are several other air conditioners, the VRV system is off, and that temperature changes even when the thermostat sensor is off.)

Body thermostat sensor is used for temperatures from 64°F to 73°F (A → C).

Remote controller thermostat sensor is used for temperatures from 73°F to 81°F (C → E).

Body thermostat sensor is used for temperatures from 81°F to 86°F (E → F).

And, assuming suction temperature has changed from 86°F to 64°F (F → A):

Body thermostat sensor is used for temperatures from 86°F to 77°F (F → D).

Remote controller thermostat sensor is used for temperatures from 77°F to 70°F (D → B).

Body thermostat sensor is used for temperatures from 70°F to 64°F (B → A).

Heating

When heating, the hot air rises to the top of the room, resulting in the temperature being lower near the floor where the occupants are. When controlling by body thermostat sensor only, the unit may therefore be turned off by the thermostat before the lower part of the room reaches the preset temperature. The temperature can be controlled so the lower part of the room where the occupants are doesn't become cold by widening the range in which thermostat sensor in remote controller can be used so that suction temperature is higher than the preset temperature.

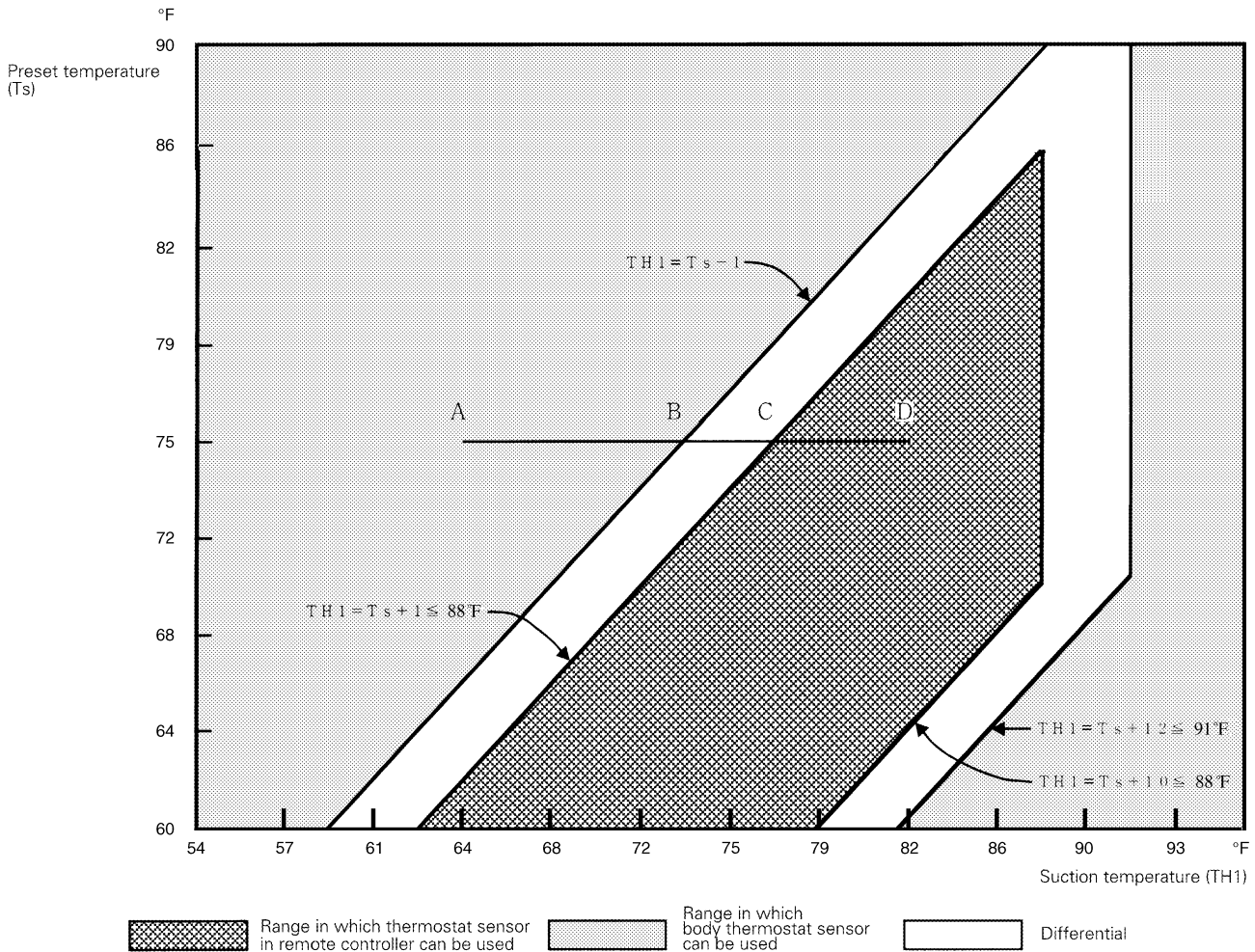

(V2769)

■ **Ex: When heating**

Assuming the preset temperature in the figure above is 75°F, and the suction temperature has changed from 64°F to 82°F (A → D):

(This example also assumes there are several other air conditioners, the VRV system is off, and that temperature changes even when the thermostat sensor is off.)

Body thermostat sensor is used for temperatures from 64°F to 77°F (A → C).

Remote controller thermostat sensor is used for temperatures from 77°F to 82°F (C → D).

And, assuming suction temperature has changed from 82°F to 64°F (D → A):

Remote controller thermostat sensor is used for temperatures from 82°F to 73°F (D → B).

Body thermostat sensor is used for temperatures from 73°F to 64°F (B → A).

6.4 Freeze Prevention

Freeze Prevention by Off Cycle (Indoor Unit)

When the temperature detected by liquid pipe temperature thermistor (R2T) of the indoor unit heat exchanger drops too low, the unit enters freeze prevention operation in accordance with the following conditions, and is also set in accordance with the conditions given below.

Conditions for starting freeze prevention: Temperature is 30°F or less for total of 40 min., or temperature is 23°F or less for total of 10 min.

Conditions for stopping freeze prevention: Temperature is 45°F or more for 10 min. continuously.

Ex: Case where temperature is 23°F or less for total of 10 min.

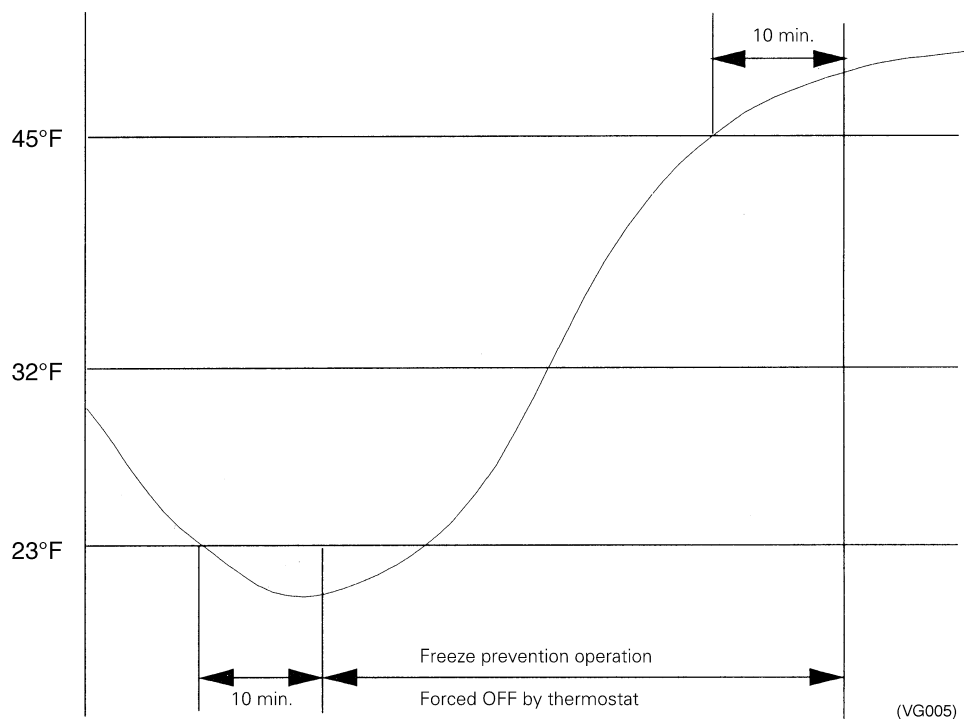

(VG005)

6.5 View of Operations of Swing Flaps

Swing flaps work as following.

			Fan	Flap control		
				FCQ	FHQ	
Heating	Hot-start from defrosting	Swinging	OFF	Level	Level	
		Setting the wind direction	OFF	Level	Level	
	Defrosting	Swinging	OFF	Level	Level	
		Setting the wind direction	OFF	Level	Level	
	Thermostat is off	Swinging	LL	Level	Level	
		Setting the wind direction	LL	Level	Level	
	Hot-start from the state that the thermostat is off	Swinging	LL	Level	Level	
		Setting the wind direction	LL	Level	Level	
	Halt	Swinging	OFF	Level	Level	
		Setting the wind direction	OFF	Level	Level	
	Cooling	Thermostat of microcomputer-dry is on	Swinging	L ^{*1}	Swinging	Swinging
			Setting the wind direction	L ^{*1}	Set up	Set up
Thermostat of microcomputer-dry is off		Swinging	OFF	Swinging	Swinging	
		Setting the wind direction	or L	Set up	Set up	
Cooling thermostat is off		Swinging	Set up	Swinging	Swinging	
		Setting the wind direction	Set up	Set up	Set up	
Halt		Swinging	OFF	Level	Level	
		Setting the wind direction	OFF	Set up	Level	
Microcomputer is controlled (including the cooling state)		Swinging	L	Swinging	Swinging	
		Setting the wind direction	L	Set up	Set up	

* 1. Only in FCQ case, L or LL.

Part 6

Test Operation

- 1. Test Operation46
 - 1.1 Procedure and Outline 46
 - 1.2 Operation When Power is Turned On..... 49
- 2. Outdoor Unit PC Board Layout50
- 3. Field Setting51
 - 3.1 Field Setting from Remote Controller..... 51
 - 3.2 Field Setting from Outdoor Unit 62
 - 3.3 Detail of Setting Mode..... 68

1. Test Operation

1.1 Procedure and Outline

Follow the following procedure to conduct the initial test operation after installation.

1.1.1 Check Work Prior to Turn Power Supply On

Check the below items.

- Power wiring
- Control transmission wiring between units
- Earth wire



Check on refrigerant piping



Check on amount of refrigerant charge

- Is the power supply single-phase 208-230V / 60Hz?
- Have you finished a ductwork to drain?
- Have you detach transport fitting?
- Is the wiring performed as specified?
- Are the designated wires used?
- Is the grounding work completed?
 - Use a 500V megger tester to measure the insulation.
 - Do not use a megger tester for other circuits than 200-230V circuit.
- Are the setscrews of wiring not loose?
- Is the electrical component box covered with an insulation cover completely?

- Is pipe size proper? (The design pressure of this product is 580 psi.)
- Are pipe insulation materials installed securely?
 - Liquid and gas pipes need to be insulated. (Otherwise causes water leak.)
- Are respective stop valves on liquid and gas line securely open?

- Is refrigerant charged up to the specified amount?
 - If insufficient, charge the refrigerant from the service port of stop valve on the liquid side with outdoor unit in stop mode after turning power on.
- Has the amount of refrigerant charge been recorded on “Record Chart of Additional Refrigerant Charge Amount”?

(V3180)

1.1.2 Turn Power On

Turn outdoor unit power on.



Turn indoor unit power on.



Carry out field setting on outdoor PC board

- Be sure to turn the power on 6 hours before starting operation to protect compressors.
- Close outside panels of the outdoor unit.

(V3056)

1.1.3 Check Operation

- * During check operation, mount front panel to avoid the misjudging.
- * Check operation is mandatory for normal unit operation.
(When the check operation is not executed, alarm code "U3" will be displayed.)

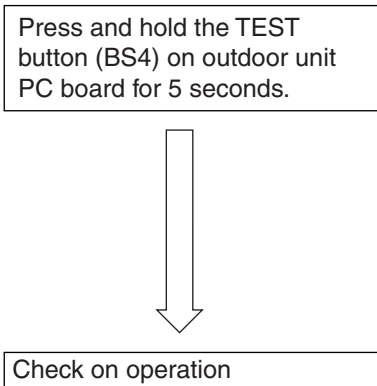

○ The test operation is started automatically.
The following judgements are conducted within 15 minutes(about 30 minutes at the maximum).

- “Check for wrong wiring”
- “Check stop valve for not open”
- “Pipe length automatic judgement”

The following indications are conducted while in test operation.

- LED lamp on outdoor unit PC board — H2P flickers (test operation)
- Remote controller — Indicates “Under Centralized Control” on upper right.
Indicates “Test Operation” on lower left

(V3057)

On completion of test operation, LED on outdoor unit PC board displays the following.
 H3P ON: Normal completion
 H2P and H3P ON: Abnormal completion → Check the indoor unit remote controller for abnormal display and correct it.



Malfunction code

In case of an alarm code displayed on remote controller:

Malfunction code	Nonconformity during installation	Remedial action
E3	The shutoff valves in the outdoor unit remain closed.	Open the shutoff valve on both the gas side and liquid side.
	The refrigerant is overcharged.	Calculate again the required quantity of refrigerant to be charged based on the piping length, recover the refrigerant using the refrigerant recovery device, then achieve proper quantity of refrigerant.
E4 F3	The shutoff valves in the outdoor unit remain closed.	Open the shutoff valve on both the gas side and liquid side.
	The operation mode on the remote controller was changed before the check run.	Set the operating mode on all indoor unit remote controllers to “cooling”.
	The refrigerant is insufficient.	<ul style="list-style-type: none"> • Check whether additional refrigerant charge has been finished correctly. • Calculate again the required quantity of refrigerant to be charged based on the piping length, then charge additionally proper quantity of refrigerant.
F6	The refrigerant is overcharged.	Calculate again the required quantity of refrigerant to be charged based on the piping length, recover the refrigerant using the refrigerant recovery device, then achieve proper quantity of refrigerant.
U3	The check operation is not performed.	Perform the check operation.
U4	The power is not supplied to the outdoor unit.	Connect correctly the power cable of the outdoor unit.
UA	Improper type of indoor units are connected.	Check the type of indoor units currently connected. If they are not proper, replace them with proper ones.

UF	The shutoff valves in the outdoor unit remain closed.	Open the shutoff valve on both the gas side and liquid side.
	The piping and wiring of the specified indoor unit are not connected correctly to the outdoor unit.	Confirm that the piping and wiring of the specified indoor unit are connected correctly to the outdoor unit.
	The operation mode on the remote controller was changed before the check run.	Set the operating mode on all indoor unit remote controllers to "cooling".
UH	The unit-to-unit wirings are not connected correctly.	Connect correctly the unit-to-unit wirings to the F1 and F2(TO IN/D UNIT) terminals on the PC board (A1P) in the outdoor unit.

1.1.4 Confirmation on Normal Operation

- Conduct normal unit operation after the check operation has been completed.
(When outdoor air temperature is 86°FDB or higher, the unit can not be operated with heating mode. See the installation manual attached.)
- Confirm that the indoor/outdoor units can be operated normally.
(When an abnormal noise due to liquid compression by the compressor can be heard, stop the unit immediately, and turn on the crankcase heater to heat up it sufficiently, then start operation again.)
- Operate indoor unit one by one to check that the corresponding outdoor unit operates.
- Confirm that the indoor unit discharges cold air (or warm air).
- Operate the air direction control button and flow rate control button to check the function of the devices.

1.2 Operation When Power is Turned On

1.2.1 When Turning On Power First Time

The unit cannot be run for up to 12 minutes to automatically set the master power and address (indoor-outdoor address, etc.).

Status

Outdoor unit

Test lamp H2P Blinks

Can also be set during operation described above.

Indoor unit

If ON button is pushed during operation described above, the "UH" malfunction indicator blinks. (Returns to normal when automatic setting is complete.)

1.2.2 When Turning On Power the Second Time and Subsequent

Tap the RESET(BS5) button on the outdoor unit PC board. Operation becomes possible for about 2 minutes. If you do not push the RESET button, the unit cannot be run for up to 10 minutes to automatically set master power.

Status

Outdoor unit

Test lamp H2P Blinks

Can also be set during operation described above.

Indoor unit

If ON button is pushed during operation described above, the operation lamp lights but the compressor does not operate. (Returns to normal when automatic setting is complete.)

1.2.3 When an Indoor Unit or Outdoor Unit Has Been Added, or Indoor or Outdoor Unit PC Board Has Been Changed

Be sure to push and hold the RESET button for 5 seconds. If not, the addition cannot be recognized. In this case, the unit cannot be run for up to 12 minutes to automatically set the address (indoor-outdoor address, etc.).

Status

Outdoor unit

Test lamp H2P ON

Can also be set during operation described above.

Indoor unit

If ON button is pushed during operation described above, the "UH" or "U4" malfunction indicator blinks. (Returns to normal when automatic setting is complete.)

2. Outdoor Unit PC Board Layout

Outdoor unit PC board

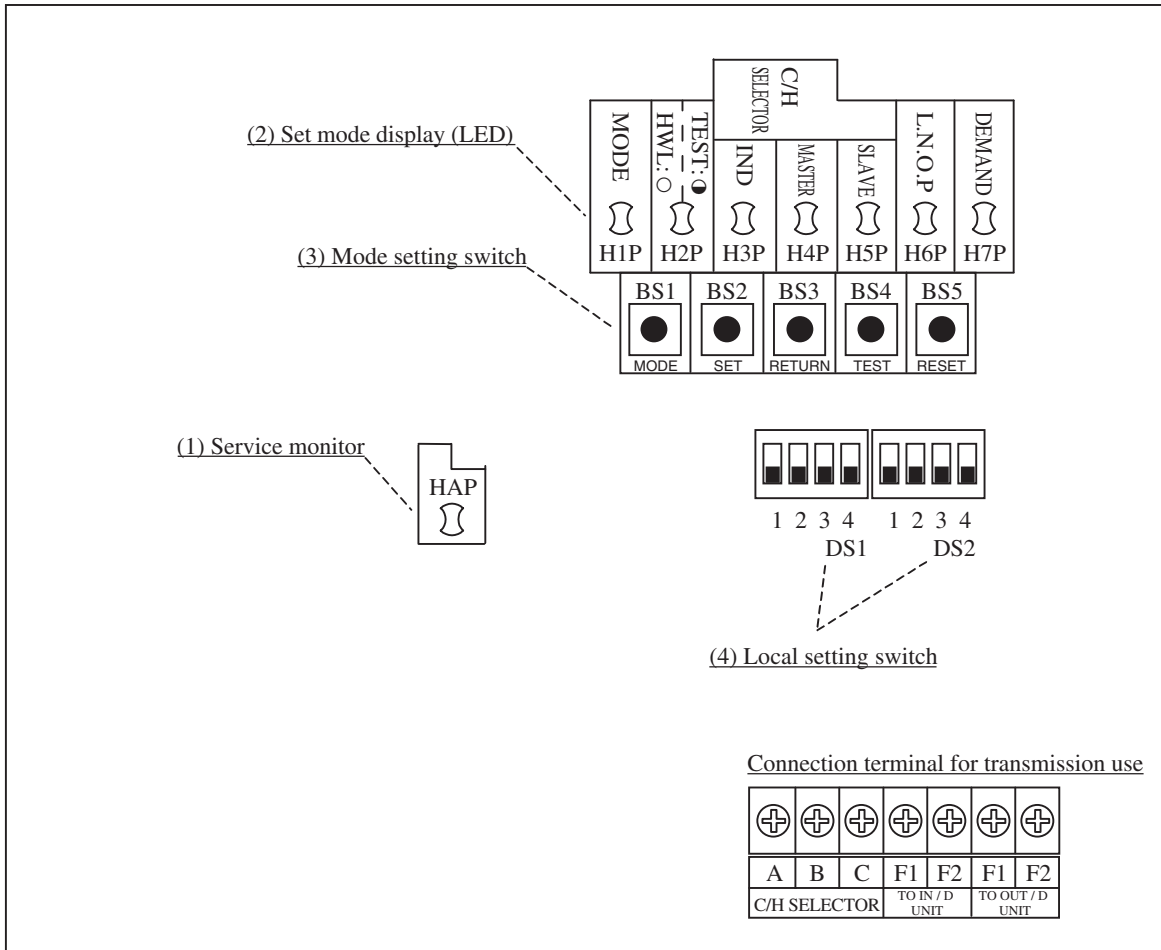

(V3171)

- (1) Service monitor (LED Green)
This monitor blinks while in normal operation, and turns on or off when a malfunction occurs.
- (2) Set mode display (LED Orange)
LEDs display mode according to the setting.
- (3) Mode setting switch
Used to change mode.
- (4) Local setting switch
Used to make local settings.

3. Field Setting

3.1 Field Setting from Remote Controller

Individual function of indoor unit can be changed from the remote controller. At the time of installation or after service inspection / repair, make the local setting in accordance with the following description.

Wrong setting may cause malfunction.





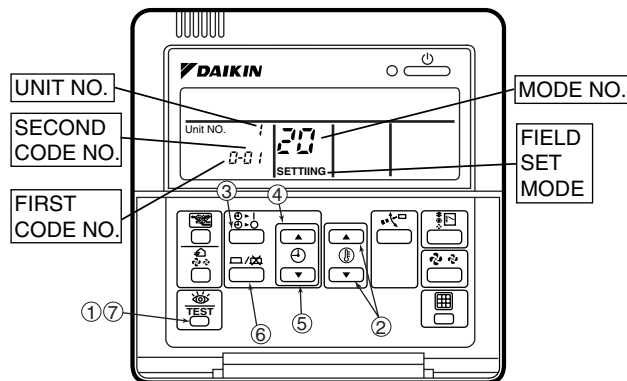

(When optional accessory is mounted on the indoor unit, setting for the indoor unit may be required to change. Refer to information in the option handbook.)

3.1.1 Wired Remote Controller <BRC1C71>

If optional accessories are mounted on the indoor unit, the indoor unit setting may have to be changed. Refer to the instruction manual for each optional accessory.



2P068938

1. When in the normal mode, press the “” button for a minimum of four seconds, and the FIELD SET MODE is entered.
2. Select the desired MODE NO. with the “” button (2).
3. During group control, when setting by each indoor unit (mode No. 20, 21 and 23 have been selected), push the “” button (3) and select the INDOOR UNIT NO to be set. (This operation is unnecessary when setting by group.)
4. Push the “” upper button (4) and select FIRST CODE NO.
5. Push the “” lower button (5) and select the SECOND CODE NO.
6. Push the “” button (6) once and the present settings are SET.
7. Push the “” button (7) for about one second to return to the NORMAL MODE.

(Example)

If during group setting and the time to clean air filter is set to FILTER CONTAMINATION, HEAVY, SET MODE NO. to “10” FIRST CODE NO. to “0,” and SECOND CODE NO. to “02.”





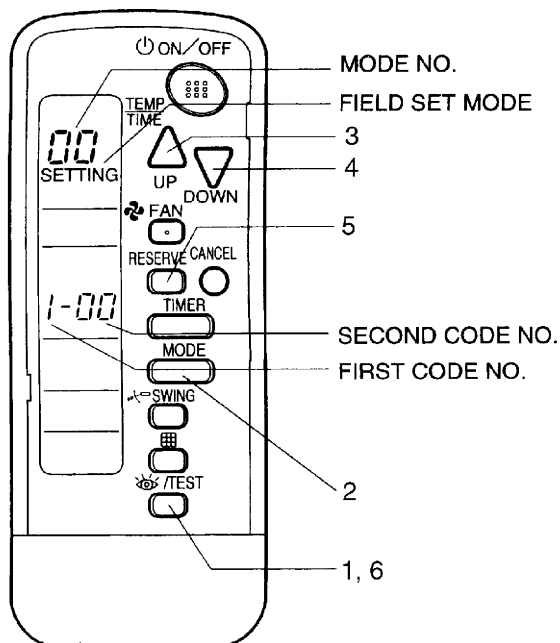

3.1.2 Wireless Remote Controller - Indoor Unit

BRC7C812

BRC7E83



(V2770)

1. When in the normal mode, push the  button for 4 seconds or more, and operation then enters the “field set mode.”
2. Select the desired “mode No.” with the  button.
3. Pushing the  button, select the first code No.
4. Pushing the  button, select the second code No.
5. Push the timer  button and check the settings.
6. Push the  button to return to the normal mode.

(Example)

When setting the filter sign time to “Filter Dirtiness-High” in all group unit setting, set the Mode No. to “10”, Mode setting No. to “0” and setting position No. to “02”.

3.1.3 Simplified Remote Controller BRC2A71

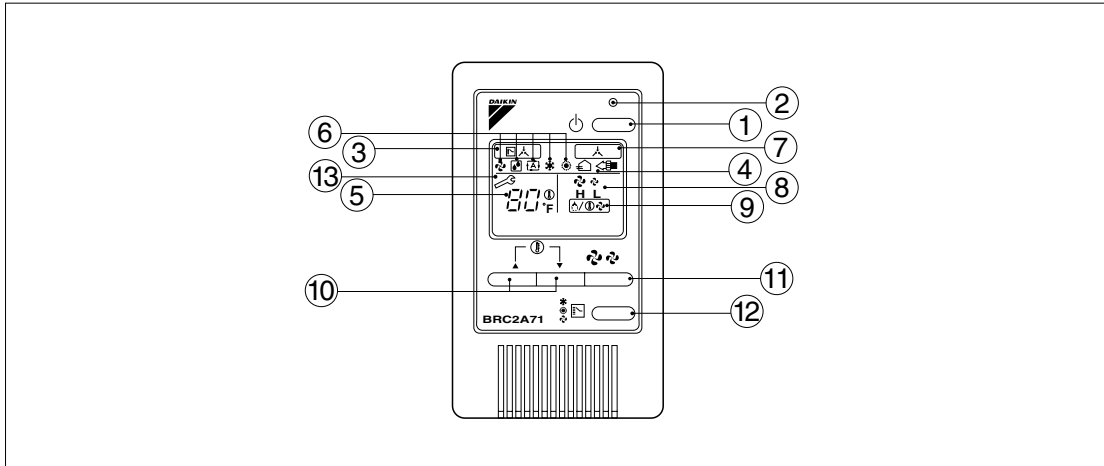

REMOTE CONTROLLER: NAME AND FUNCTION OF EACH SWITCH AND DISPLAY

①	ON/OFF BUTTON	⑦	DISPLAY “ [人] ” (UNDER CENTRALIZED CONTROL)
	Press the button and the system will start. Press the button again and the system will stop.		When this display shows, the system is UNDER CENTRALIZED CONTROL. (This is not a standard specification)
②	OPERATION LAMP (RED)	⑧	DISPLAY “ H L ” (FAN SPEED)
	The lamp lights up during operation. Blinks in case of stop due to malfunction.		This display shows the fan speed: HIGH or LOW.
③	DISPLAY “ [人] ” (CHANGEOVER UNDER CONTROL)	⑨	DISPLAY “ [人] ” (DEFROST / HOT START)
	It is impossible to changeover heating/cooling with the remote controller when it shows this display. (As for details, see “SETTING OF MASTER REMOTE CONTROLLER” in the installation manual attached to the indoor unit.)		Indicates that defrost or hot start (during which the fan is stopped till the temperature of air supply rises enough at the start of a heating operation) is in progress.
④	DISPLAY “ [人] ” (VENTILATION/AIR)	⑩	TEMPERATURE SETTING BUTTON
	This display shows that the total heat exchanger and the air cleaning unit are in operation. (These are optional accessories).		Use this button for SETTING TEMPERATURE of the thermostat. ▲ ; Each press raises the set temperature by 1°F. ▼ ; Each press lowers the set temperature by 1°F. The variable temperature range is between 60°F and 90°F.
⑤	DISPLAY “ 80°F ” (SET TEMPERATURE)	⑪	FAN SPEED CONTROL BUTTON
	This display shows the set temperature. Only given during a cooling or heating operation.		Press this button to select the fan speed, HIGH or LOW, of your choice.
⑥	DISPLAY “ [人] ” “ [人] ” “ [人] ” “ [人] ” “ [人] ” (OPERATION MODE)	⑫	OPERATION MODE SELECTOR BUTTON
	This display shows current OPERATION MODE. “ [人] ” is not available with outdoor units specially designed for cooling only. “ [人] ” is reserved only for outdoor units capable of heat recovery.		Press this button to select OPERATION MODE.
		⑬	DISPLAY “ [人] ” (MALFUNCTION)
			Indicates malfunction and blinks if the unit stops operating due to malfunction. (As for details, see “TROUBLE SHOOTING” in the operation manual attached to the outdoor unit.)

For the sake of explanation, all indications are shown in the figure above contrary to actual running situations.

3P146204

3.1.4 Setting Contents and Code No. – VRV Unit

Field Setting Contents and Code No.

Mode No. Note)2	FIRST CODE No.	Description of Setting	SECOND CODE NO. Note)3					
			01	02	03	04		
10(20)	0	Filter Contamination-Heavy/ Light (Setting for display time to clean air filter) (Sets display time to clean air filter to half when there is heavy filter contamination.)	Ultra-Long-Life Type	Approx. 10,000 hours	Approx. 5,000 hours	—	—	
		Long-Life Type	Light	Approx. 2,500 hours	Heavy			Approx. 1,250 hours
		Standard Type	Approx. 200 hours	Approx. 100 hours				
	1	Long-life filter type (Setting of filter sign indication time) (Change setting when Ultra-long-life filter is installed)	Long-Life Filter	Ultra-Long- Life Filter	—	—		
2	Thermostat Sensor in Remote Controller	Use	Not Use	—	—			
3	Display Time to Clean Air Filter Calculation (Set when filter sign is not to be displayed)	Display	Do not Display	—	—			
12(22)	0	Optional accessories output selection (field selection of output for adaptor for wiring)	Indoor Unit Turned ON by Thermostat	—	Operation Output	Malfunction Output		
	1	ON/OFF Input from Outside (Set when ON/OFF is to be controlled from outside.)	Forced Off	ON/OFF Control	External Protection Device Input	—		
	2	Thermostat Differential Changeover (Set when remote sensor is to be used.) FCQ only	2°F	1°F	—	—		
	5	Power failure automatic reset (Auto Restart)	No equipped	Equipped	—	—		
13(23)	4	Field set air flow position setting	Draft Prevention	Standard	Ceiling Soiling Prevention	—		
	5	Field set fan speed selection (fan speed control by air discharge outlet for phase control)	Standard	Optional Accessory 1	Optional Accessory 2	—		



Notes:

- Settings are made simultaneously for the entire group, however, if you select the mode No. inside parentheses, you can also set by each individual unit. Setting changes however cannot be checked except in the individual mode for those in parentheses.
- The mode numbers inside parentheses cannot be used by wireless remote controllers, so they cannot be set individually. Setting changes also cannot be checked.
- Marked are factory set.
- Do not make settings other than those described above. Nothing is displayed for functions the indoor unit is not equipped with.
- “88” may be displayed to indicate the remote controller is resetting when returning to the normal mode.

3.1.5 Applicable Range of Field Setting

Mode No.	Setting Switch No.	Setting Contents	Ceiling mounted cassette type (Multi flow)	Ceiling suspended type
			FCQ	FHQ
10 (20)	0	Filter sign	○	○
	1	Ultra long life filter sign	○	—
	2	Remote controller thermostat sensor	○	○
12 (22)	3	Set fan speed when thermostat OFF	○	○
13 (23)	0	Air flow adjustment Ceiling height	○	○
	1	Air flow direction	○	—
	3	Air flow direction adjustment (Down flow operation)	—	—
	4	Air flow direction adjustment range	○	—
	5	Field set fan speed selection	—	—

3.1.6 Detailed Explanation of Setting Modes

Filter Sign Setting

If switching the filter sign ON time, set as given in the table below.

Set Time

Filter Specs. Setting	Mode No.	Setting Switch No.	Setting Position No.	Lighting interval of the filter sign (hours)		
				Standard	Long Life	Ultra Long Life Filter
Contamination Light	10(20)	0	01	200 hrs.	2,500 hrs.	10,000 hrs.
Contamination Heavy			02	100 hrs.	1,250 hrs.	5,000 hrs.

Fan Speed Changeover When Thermostat is OFF

By setting to “Set Fan Speed,” you can switch the fan speed to the set fan speed when the heating thermostat is OFF.

* Since there is concern about draft if using “fan speed up when thermostat is OFF,” you should take the setup location into consideration.

On warming, the priority is given to this over "airflow OFFSW on thermostat off".

© This is used to correspond with the improvement of the electrical collection capability.

Setting Table

Mode No.	First Code No.	Second Code No.	Setting
12(22)	3	01	LL Fan Speed
		02	Set Fan Speed

Auto Restart after Power Failure Reset

For the air conditioners with no setting for the function (same as factory setting), the units will be left in the stop condition when the power supply is reset automatically after power failure reset or the main power supply is turned on again after once turned off. However, for the air conditioners with the setting, the units may start automatically after power failure reset or the main power supply turned on again (return to the same operation condition as that of before power failure).

For the above reasons, when the unit is set enabling to utilize “Auto restart function after power failure reset”, utmost care should be paid for the occurrence of the following situation.



- Caution**
- 1. The air conditioner starts operation suddenly after power failure reset or the main power supply turned on again. Consequently, the user might be surprised (with question for the reason why).**
 - 2. In the service work, for example, turning off the main power switch during the unit is in operation, and turning on the switch again after the work is completed start the unit operation (the fan rotates).**

Setting of Air Flow Direction Adjustment Range

Make the following air flow direction setting according to the respective purpose.

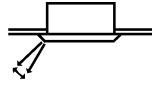

(S2537)

Setting Table

Mode No.	First Code No.	Second Code No.	Setting
13 (23)	4	01	Upward (Draft prevention)
		02	Standard
		03	Downward (Ceiling soiling prevention)

3.1.7 Centralized Control Group No. Setting

BRC1C Type



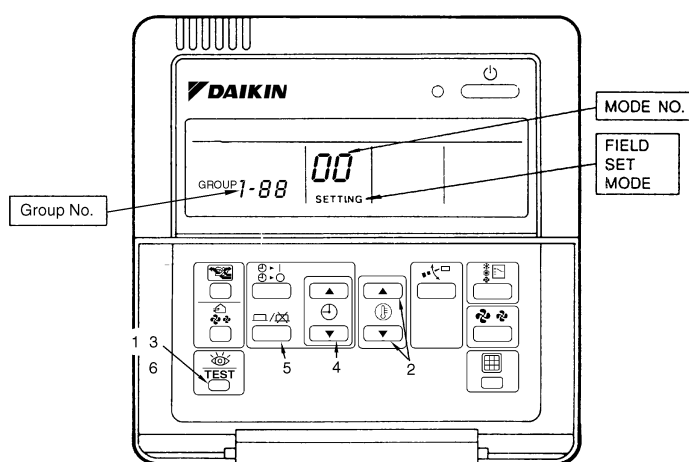



- If carrying out centralized control by central remote controller or unified ON/OFF controller, group No. must be set for each group individually by remote controller.
 - Group No. setting by remote controller for centralized control
1. If the inspection/test button is pushed for 4 seconds or more when in the normal mode, operation enters the “field set mode.”
 2. Using the temperature control buttons, set the mode No. to “00.”
 3. Push the inspection/test button to inspect the group No. display.
 4. Using the programming time button, set the group No. for each group. (Group No. rises in the order of 1-00, 1-01, ...1-15, 2-00 ...4-15, etc. The unified ON/OFF controller however displays only the range of group numbers selected by the switch for setting each address.)
 5. Push the timer ON/OFF button and enter the selected group No.
 6. Push the inspection/test button and return to the normal mode.



(S1095)

* If the address has to be set individually for each unit for power consumption counting, etc., set the mode No. to “30.”

**BRC7C Type
BRC7E Type**

- Group No. setting by wireless remote controller for centralized control
- 1. When in the normal mode, push  button for 4 seconds or more, and operation then enters the "field set mode."
- 2. Set mode No. "00" with  button.
- 3. Set the group No. for each group with   button (advance/backward).
- 4. Enter the selected group numbers by pushing  button.
- 5. Push  button and return to the normal mode.

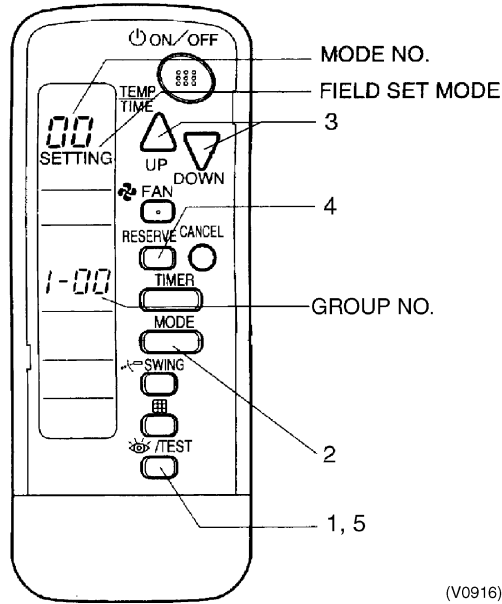

(V0916)

**Group No. Setting
Example**

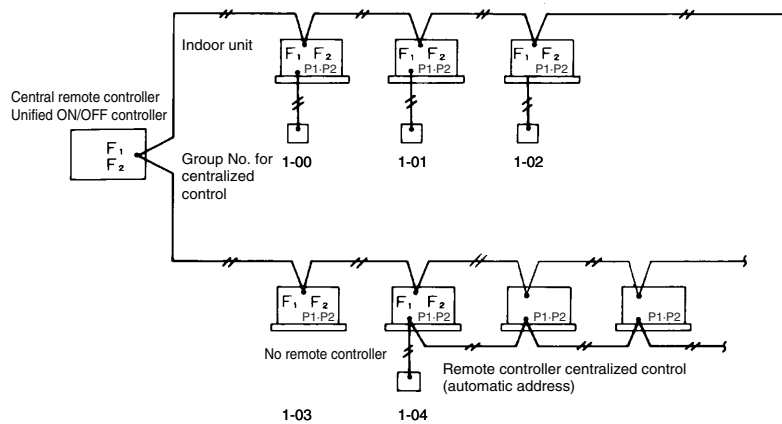

(V3170)



Caution

When turning the power supply on, the unit may often not accept any operation while "88" is displaying after all indications were displayed once for about 1 minute on the liquid crystal display. This is not an operative fault.

3.1.8 Setting of Operation Control Mode from Remote Controller (Local Setting)

The operation control mode is compatible with a variety of controls and operations by limiting the functions of the operation remote controller. Furthermore, operations such as remote controller ON/OFF can be limited in accordance with the combination conditions. (Refer to information in the table below.)

Centralized controller is normally available for operations. (Except when centralized monitor is connected)

3.1.9 Contents of Control Modes

Twenty modes consisting of combinations of the following five operation modes with temperature and operation mode setting by remote controller can be set and displayed by operation modes 0 through 19.

- ◆ ON/OFF control impossible by remote controller
Used when you want to turn on/off by central remote controller only.
(Cannot be turned on/off by remote controller.)
- ◆ OFF control only possible by remote controller
Used when you want to turn on by central remote controller only, and off by remote controller only.
- ◆ Centralized
Used when you want to turn on by central remote controller only, and turn on/off freely by remote controller during set time.
- ◆ Individual
Used when you want to turn on/off by both central remote controller and remote controller.
- ◆ Timer operation possible by remote controller
Used when you want to turn on/off by remote controller during set time and you do not want to start operation by central remote controller when time of system start is programmed.

How to Select Operation Mode

Whether operation by remote controller will be possible or not for turning on/off, controlling temperature or setting operation mode is selected and decided by the operation mode given on the right edge of the table below.

Example

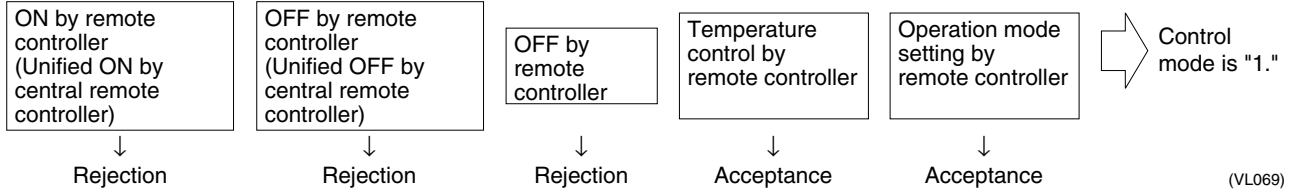

Control mode	Control by remote controller					Control mode	
	Operation		OFF	Temperature control	Operation mode setting		
	Unified operation, individual operation by central remote controller, or operation controlled by timer	Unified OFF, individual stop by central remote controller, or timer stop					
ON/OFF control impossible by remote controller	Rejection (Example)	Rejection (Example)	Rejection (Example)	Rejection	Acceptance	0	
OFF control only possible by remote controller				Acceptance (Example)	Acceptance (Example)	Acceptance (Example)	1 (Example)
					Rejection	Rejection	11
Centralized	Acceptance		Acceptance	Acceptance	Rejection	Acceptance	2
					Acceptance	Rejection	12
Rejection					Acceptance	3	
Acceptance		Rejection			13		
Individual	Acceptance	Acceptance		Acceptance	Rejection	Acceptance	4
					Acceptance	Rejection	14
Rejection			Acceptance		5		
Acceptance			Rejection		15		
Timer operation possible by remote controller	Acceptance (During timer at ON position only)		Rejection (During timer at OFF position)	Acceptance	Rejection	Acceptance	6
					Acceptance	Rejection	16
		Rejection			Acceptance	7 *1	
		Acceptance			Rejection	17	
		Rejection (During timer at OFF position)		Acceptance	Rejection	Acceptance	8
					Acceptance	Rejection	18
Rejection	Acceptance		9				
Acceptance	Rejection		19				

Do not select "timer operation possible by remote controller" if not using a remote controller. Operation by timer is impossible in this case.

*1. Factory setting

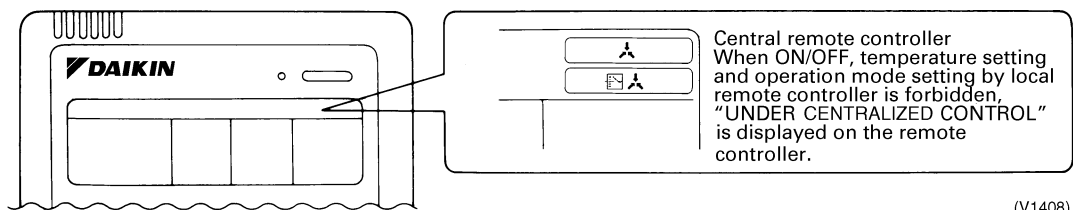

3.2 Field Setting from Outdoor Unit

3.2.1 Setting by dip switches

The following field settings are made by dip switches on PC board.

Dipswitch		Setting item	Description
No.	Setting		
DS1-1	ON	Cool / Heat change over setting	Do not change the factory setting.
	OFF (Factory set)		
DS1-2 ~DS1-4	ON	Not used	Do not change the factory settings.
	OFF (Factory set)		
DS2-1 ~4	ON	Not used	Do not change the factory settings.
	OFF (Factory set)		



Caution

DIP switch Setting after changing the main PC board(A1P) to spare parts PC board

When you change the main PC board(A1P) to spare parts PC board, please carry out the following setting.

The spare parts PC board is different from the PC board on factory shipment above in a way of setting. When you exchange to the spare parts PC board, make sure that you change setting referring the following table.



DIP Switch Detail

DS No.	Item	Contents				
DS1-1	Cool/Heat change over setting	ON	Do not set.			
		OFF	The Cool/Heat change over is carried out by remote controller fitted to indoor unit.			
DS1-2	Cooling only/Heat-pump setting	ON	Cooling only			
		OFF	Heat-pump			
DS1-3 DS1-4	Not used	Do not change the factory settings.				
DS2-1	HP setting (Horse power)	The following setting is performed according to capacity of the outdoor unit.				
			RZQ24MVJU	RZQ30MVJU	RZQ36MVJU	RZQ42MVJU
DS2-2		DS2-1	ON	OFF	OFF	OFF
DS2-3		DS2-2	OFF	ON	OFF	OFF
DS2-4		DS2-3	OFF	OFF	ON	ON
	DS2-4	OFF	OFF	OFF	OFF	

■ **Setting by pushbutton switches**

The following settings are made by pushbutton switches on PC board.

	H1P	H2P	H3P	H4P	H5P	H6P	H7P
LED display	●	●	○	●	●	●	●

(Factory setting)

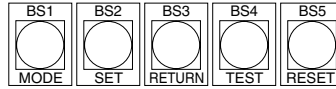

(V2760)

There are the following three setting modes.

① **Setting mode 1 (H1P off)**

Initial status (when normal) : Also indicates during “abnormal”.

② **Setting mode 2 (H1P on)**

Used to modify the operating status and to set program addresses, etc. Usually used in servicing the system.

③ **Monitor mode (H1P blinks)**

Used to check the program made in Setting mode 2.

■ **Mode changing procedure**

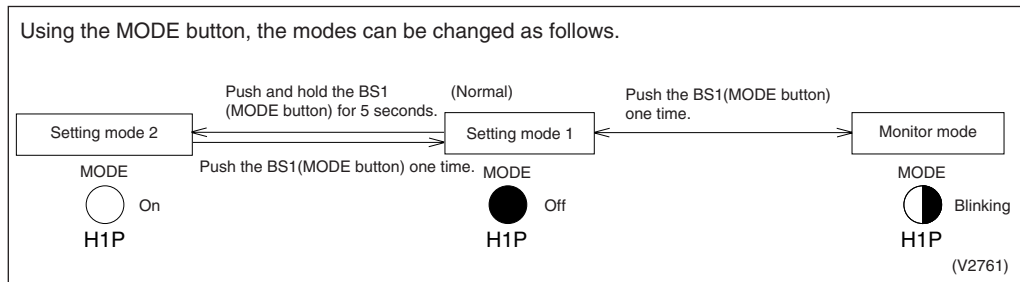

■ **Mode changing procedure**

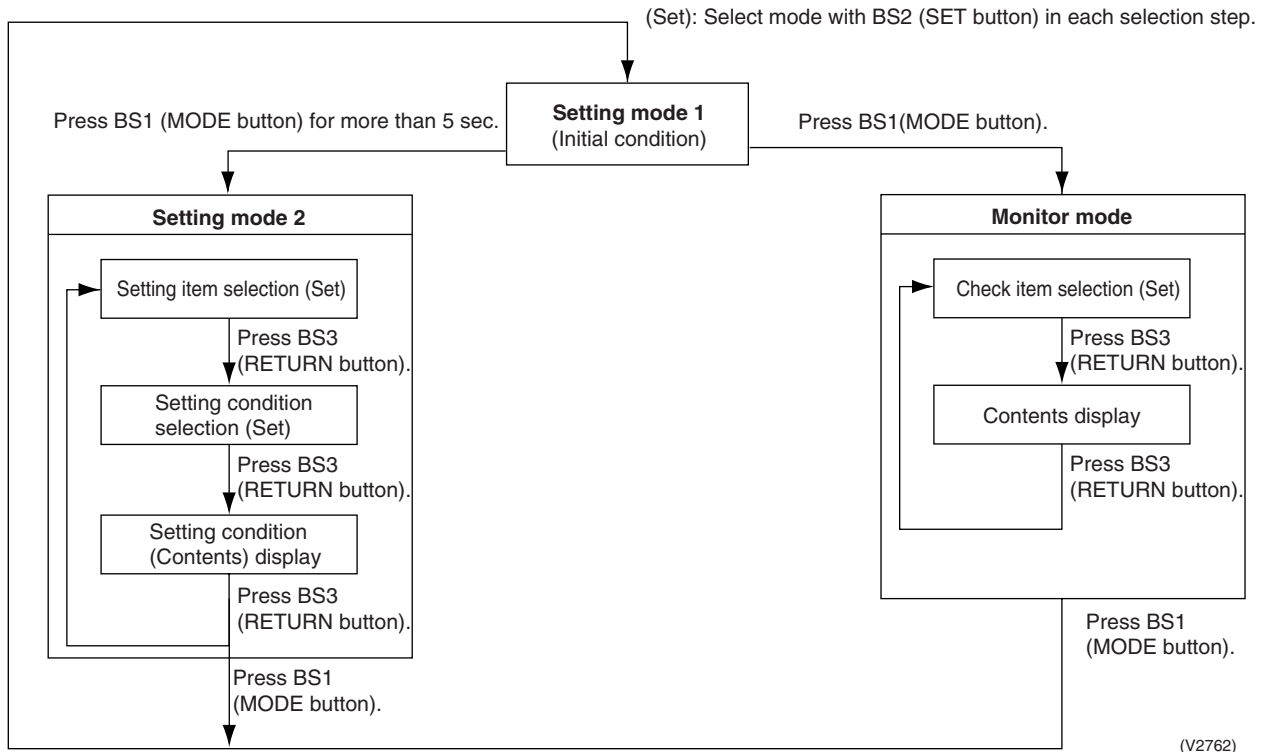

a. “Setting mode 1”

Normally, “Setting mode 1” is set. In case of other status, push MODE button (BS1) one time and set to “Setting mode 1”.



* The current state is displayed.

Display for malfunction/preparing/test-run

Setting (displaying) item	LED display example						
	H1P	H2P	H3P	H4P	H5P	H6P	H7P
Normal	●	●	○	●	●	●	●
Malfunction	●	○	○	●	●	●	●
Preparing/Test-run	●	◐	○	●	●	●	●

○ : ON ● : OFF ◐ : Blink

b. "Setting mode 2"

Push and hold the MODE button (BS1) for 5 seconds and set to "Setting mode 2".

<Selection of setting items>

Push the SET button (BS2) and set the LED display to a setting item shown in the table on the right.
↓
Push the RETURN button (BS3) and decide the item. (The present setting condition is blinked.)

<Selection of setting conditions>

Push the SET button (BS2) and set to the setting condition you want.
↓
Push the RETURN button (BS3) and decide the condition.

Push the RETURN button (BS3) and set to the initial status of "Setting mode 2".

No.	Setting item	Description
5	Indoor unit forced fan H	Allows forced operation of indoor unit fan while unit is stopped. (H tap)
6	Indoor unit forced operation	Allows forced operation of indoor unit.
8	Te setting	Target evaporation temperature for cooling
9	Tc setting	Target condensation temperature for heating
10	Defrost changeover setting	Changes the temperature condition for defrost and sets to quick defrost or slow defrost.
21	Refrigerant recovery / vacuuming mode setting	Sets to refrigerant recovery / vacuuming mode.
22	Night-time low noise setting	Sets automatic nighttime low noise operation in a simple way. The operating time is based on "Starting set" and "Ending set".
26	Night-time low noise operation start setting	Sets starting time of nighttime low noise operation. (Night-time low noise setting is also required.)
27	Night-time low noise operation end setting	Sets ending time of nighttime low noise operation. (Night-time low noise setting is also required.)
29	Capacity precedence setting	If the capacity control is required, the low noise control is automatically released by this setting during carrying out low noise operation and nighttime low noise operation.
30	Demand setting 1	Changes target value of power consumption when demand control 1 is input.
32	Normal demand setting	Normally enables demand control 1 without external input. (Effective to prevent a problem that circuit breaker of small capacity is shut down due to large load.)

* If you become unsure of how to proceed, push the MODE button (BS1) and return to setting mode 1.

(V2764)

○ : ON ● : OFF ◐ : Blink

No.	Setting item display								Setting condition display	
	Setting item	MODE H1P	TEST H2P	C/H selection			Low noise H6P	Demand H7P		
				IND H3P	Master H4P	Slave H5P				
5	Indoor forced fan H	○	●	●	●	○	●	○	Normal operation	○ ● ● ● ● ● ● ○ *
									Indoor forced fan H	○ ● ● ● ● ● ○ ●
6	Indoor forced operation	○	●	●	●	○	○	●	Normal operation	○ ● ● ● ● ● ● ○ *
									Indoor forced operation	○ ● ● ● ● ● ○ ●
8	Te setting	○	●	●	○	●	●	●	High	○ ● ● ● ○ ● ●
									Normal	○ ● ● ● ● ● ○ ● *
									Low	○ ● ● ● ● ● ○
9	Tc setting	○	●	●	○	●	●	○	High	○ ● ● ● ○ ● ●
									Normal	○ ● ● ● ● ● ○ ● *
									Low	○ ● ● ● ● ● ○
10	Defrost changeover setting	○	●	●	○	●	○	●	Quick defrost	○ ● ● ● ○ ● ●
									Normal	○ ● ● ● ● ● ○ ● *
									Slow defrost	○ ● ● ● ● ● ○
21	Refrigerant recovery / vacuuming mode setting	○	●	○	●	○	●	○	Refrigerant recovery/ vacuuming: OFF	○ ● ● ● ● ● ○ *
									Refrigerant recovery/ vacuuming: ON	○ ● ● ● ● ● ○ ●
22	Night-time low noise setting	○	●	○	●	○	○	●	OFF	○ ● ● ● ● ● ● *
									Level 1	○ ● ● ● ● ● ○
									Level 2	○ ● ● ● ● ● ○ ●
									Level 3	○ ● ● ● ● ● ○ ○
26	Night-time low noise operation start setting	○	●	○	○	●	○	●	About 20:00	○ ● ● ● ● ● ○
									About 22:00	○ ● ● ● ● ● ○ ● *
									About 24:00	○ ● ● ● ○ ● ●
27	Night-time low noise operation end setting	○	●	○	○	●	○	○	About 6:00	○ ● ● ● ● ● ○
									About 7:00	○ ● ● ● ● ● ○ ●
									About 8:00	○ ● ● ● ○ ● ● *
29	Capacity precedence setting	○	●	○	○	○	●	○	OFF	○ ● ● ● ● ● ○ *
									ON	○ ● ● ● ● ● ○ ●
30	Demand setting 1	○	●	○	○	○	○	●	60 % demand	○ ● ● ● ● ● ○
									70 % demand	○ ● ● ● ● ● ○ ● *
									80 % demand	○ ● ● ● ○ ● ●
32	Normal demand setting	○	○	●	●	●	●	●	OFF	○ ● ● ● ● ● ○ *
									ON	○ ● ● ● ● ● ○ ●

○ : ON ● : OFF ◐ : Blink

c. Monitor mode

To enter the monitor mode, push the MODE button (BS1) when in "Setting mode 1".

<Selection of setting item>

Push the SET button (BS2) and set the LED display to a setting item.

<Confirmation on setting contents>

Push the RETURN button (BS3) to display different data of set items.

Push the RETURN button (BS3) and switches to the initial status of "Monitor mode".

No.	Setting item	LED display							Data display
		H1P	H2P	H3P	H4P	H5P	H6P	H7P	
0	Various settings	◐	●	●	●	●	●	●	See below
5	Number of connected indoor units	◐	●	●	●	○	●	○	Lower 6 digits
14	Contents of malfunction (the latest)	◐	●	●	○	○	○	●	Malfunction code table
15	Contents of malfunction (1 cycle before)	○	●	●	○	○	○	○	
16	Contents of malfunction (2 cycle before)	○	●	○	●	●	●	●	
20	Contents of retry (the latest)	○	●	○	●	○	●	●	
21	Contents of retry (1 cycle before)	○	●	○	●	○	●	○	
22	Contents of retry (2 cycle before)	○	●	○	●	○	○	●	

Setting item 0 Display contents of "Various settings"

Defrost select setting	Short	◐	●	●	●	○	●	●
	Medium	◐	●	●	●	◐	●	●
	Long	◐	●	●	●	●	●	●
Te setting	H	◐	●	●	●	●	○	●
	M	◐	●	●	●	●	◐	●
	L	◐	●	●	●	●	●	●
Tc setting	H	◐	●	●	●	●	●	○
	M	◐	●	●	●	●	●	◐
	L	◐	●	●	●	●	●	●

* Push the MODE button (BS1) and returns to "Setting mode 1".

(V2765)

Push the SET button and match with the LEDs No. 1 - 15, push the RETURN button, and enter the data for each setting.

★ Data such as addresses and number of units is expressed as binary numbers; the two ways of expressing are as follows:

◐	●	◐	●	◐	●
	16	4	1		
	32	8	2		

The No. 5 cool/heat unified address is expressed as a binary number consisting of the lower 6 digits. (0 - 63)

In ① the address is 000110 (binary number), which translates to 4 + 2 = 6 (base 10 number). In other words, the address is 6.

3.3 Detail of Setting Mode

3.3.1 Cool / Heat Mode Switching

The Cool / Heat Mode switching is carried out by remote controller fitted to indoor unit.
This setting is not required for normal operation. (Factory setted)

Set Cool / Heat Separately for Each Outdoor System by Indoor Unit Remote Controller

- ◆ Install the remote controller to indoor unit.
- ◆ Set outdoor unit PC board DS1-1 to "IN (indoor)" (factory set).

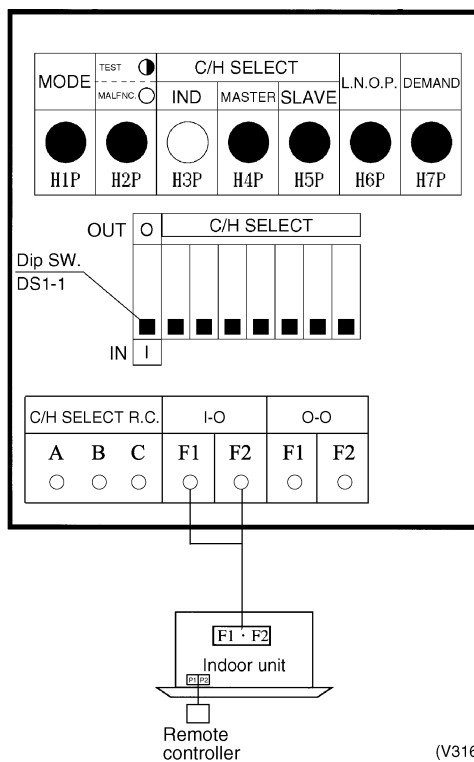

3.3.2 Setting of Low Noise Operation and Demand Operation

Setting of Low Noise Operation

By setting the low noise operation input to the outdoor unit PC board, you can lower operating noise by 2-3 dB.

Setting	Content
Mode 1	Set the outdoor unit fan to Step 6 or lower.
Mode 2	Set the outdoor unit fan to Step 5 or lower.
Mode 3	Set the outdoor unit fan to Step 4 or lower.

The low noise operation is carried out automatically at night (The external control adapter for outdoor unit is not required)

1. While in "Setting mode 2", select the setting condition (i.e., "Mode 1", "Mode 2", or "Mode 3") for set item No. 22 (Setting of nighttime low noise level).
2. If necessary, while in "Setting mode 2", select the setting condition (i.e., "20:00", "22:00", or "24:00") for set item No. 26 (Setting of start time of nighttime low noise operation).
(Use the start time as a guide since it is estimated according to outdoor temperatures.)
3. If necessary, while in "Setting mode 2", select the setting condition (i.e., "06:00", "07:00", or "08:00") for set item No. 27 (Setting of end time of nighttime low noise operation).
(Use the end time as a guide since it is estimated according to outdoor temperatures.)
4. If necessary, while in "Setting mode 2", set the setting condition for set item No. 29 (Setting of capacity precedence) to "ON".
(If the condition is set to "ON", when the air-conditioning load reaches a high level, the system will be put into normal operation mode even during nighttime.)

Image of operation

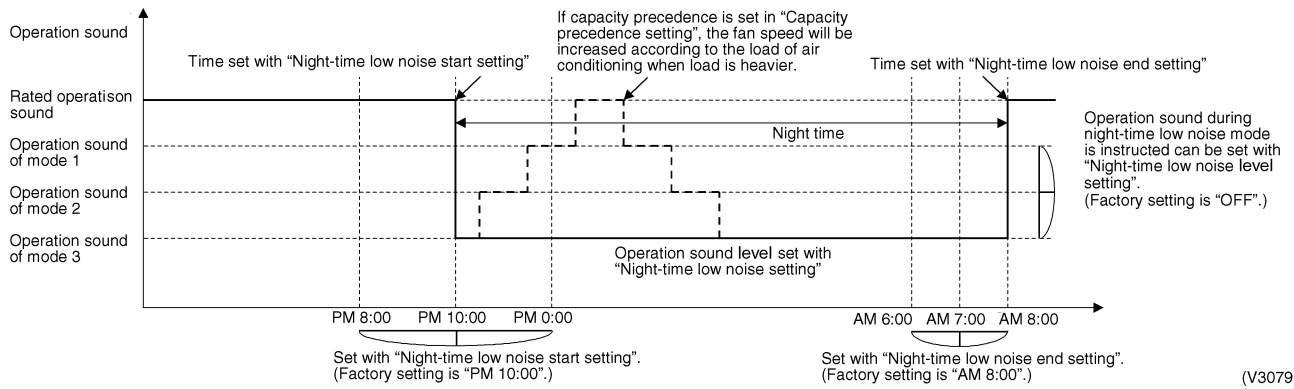

Setting of Demand Operation

By setting the demand input to the outdoor unit PC board, the power consumption of unit operation can be saved suppressing the compressor operating condition.

[Demand setting]

Setting	Standard for upper limit of power consumption
Demand setting 1	Approx. 60%
Demand setting 2 (factory setting)	Approx. 70%
Demand setting 3	Approx. 80%

The normal demand operation is carried out. (Use of the external control adaptor for outdoor unit is not required.)

1. Set the "Normal demand setting" on the outdoor unit PCB.
2. If the "Normal demand setting" is set to the "ON", set the "Demand 1 setting" on the outdoor unit PCB, as the need arises.
(During the normal demand level 1 operation, the power consumption can be saved to 80 %, 70 % or 60 % of the rated value respectively.)

Image of operation

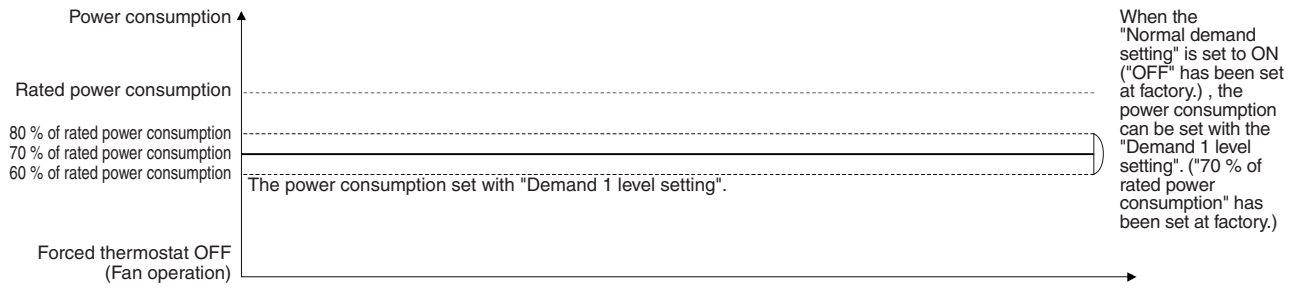

Detailed Setting Procedure of Low Noise Operation and Demand Control

1. Setting mode 1 (H1P off)

- ① In setting mode 2, push the BS1 (MODE button) one time. → Setting mode 1 is entered and H1P off.
During the setting mode 1 is displayed, “In low noise operation” and “In demand control” are displayed.

2. Setting mode 2 (H1P on)

- ① In setting 1, push and hold the BS1 (MODE button) for more than 5 seconds. → Setting mode 2 is entered and H1P lights.
- ② Push the BS2 (SET button) several times and match the LED display with the Setting No. you want.
- ③ Push the BS3 (RETURN button) one time, and the present setting content is displayed.
→ Push the BS2 (SET button) several times and match the LED display with the setting content (as shown on next page) you want.
- ④ Push the BS3 (RETURN button) two times. → Returns to ①.
- ⑤ Push the BS1 (MODE button) one time. → Returns to the setting mode 1 and turns H1P off.

○: ON ●: OFF ◐: Blink

Setting No.	Setting contents	① Setting No. indication							② Setting No. indication							Setting contents	③ Setting contents indication (Initial setting)							
		H1P	H2P	H3P	H4P	H5P	H6P	H7P	H1P	H2P	H3P	H4P	H5P	H6P	H7P		H1P	H2P	H3P	H4P	H5P	H6P	H7P	
		12	External low noise / Demand setting	○	●	●	●	●	●	●	○	●	●	○	○		●	●	NO (Factory set)	○	●	●	●	●
22	Night-time low noise setting															YES	○	●	●	●	●	●	◐	●
																OFF (Factory setting)	○	●	●	●	●	●	●	●
																Mode 1	○	●	●	●	●	●	●	◐
																Mode 2	○	●	●	●	●	●	◐	●
															Mode 3	○	●	●	●	●	●	◐	◐	
25	External low noise setting														Mode 1	○	●	●	●	●	●	●	◐	
															Mode 2 (Factory setting)	○	●	●	●	●	●	◐	●	
															Mode 3	○	●	●	●	◐	●	●	●	
26	Night-time low noise start setting														PM 8:00	○	●	●	●	●	●	●	◐	
															PM 10:00 (Factory setting)	○	●	●	●	●	●	◐	●	
															PM 0:00	○	●	●	●	◐	●	●	●	
27	Night-time low noise end setting														AM 6:00	○	●	●	●	●	●	●	◐	
															AM 7:00	○	●	●	●	●	●	◐	●	
															AM 8:00 (Factory setting)	○	●	●	●	◐	●	●	●	
29	Capacity precedence setting														Low noise precedence (Factory setting)	○	●	●	●	●	●	●	◐	
															Capacity precedence	○	●	●	●	●	●	◐	●	
30	Demand setting 1														60 % of rated power consumption	○	●	●	●	●	●	●	◐	
															70 % of rated power consumption (Factory setting)	○	●	●	●	●	●	◐	●	
															80 % of rated power consumption	○	●	●	●	◐	●	●	●	
32	Normal demand setting														OFF (Factory setting)	○	●	●	●	●	●	●	◐	
															ON	○	●	●	●	●	●	◐	●	

Setting mode indication section

Setting No. indication section

Set contents indication section

3.3.3 Setting of Refrigerant Recovery Mode

When carrying out the refrigerant collection on site, fully open the respective expansion valve of indoor and outdoor units

Both the outdoor unit and the indoor unit are forbidden to operation.

[Operation procedure]

- ① In **setting mode 2** with units in stop mode, set “Refrigerant Recovery / Vacuuming mode” to ON. The respective expansion valve of indoor and outdoor units are fully opened. (H2P turns to display “TEST OPERATION” (blinks), “TEST OPERATION” and “UNDER CENTRALIZED CONTROL” are displayed on the remote controller, and the operation is prohibited.)
- ② Collect the refrigerant using a refrigerant recovery unit. (See the instruction attached to the refrigerant recovery unit for more detail.)
- ③ Press Mode button “BS1” once and reset “Setting Mode 2”.

3.3.4 Setting of Vacuuming Mode

In order to perform vacuuming operation at site, fully open the expansion valves of indoor and outdoor units to turn on some solenoid valves.

Both the outdoor unit and the indoor unit are forbidden to operation.

[Operating procedure]

- ① With **Setting Mode 2** while the unit stops, set “Refrigerant recovery / Vacuuming mode” to ON. The expansion valves of indoor and outdoor units fully open and some of solenoid valves open.
(H2P blinks to indicate the test operation, and the remote controller displays “TEST OPERATION” and “UNDER CENTRALIZED CONTROL”, thus prohibiting operation.)
After setting, do not cancel “Setting Mode 2” until completion of Vacuuming operation.
- ② Use the vacuum pump to perform vacuuming operation.
- ③ Press Mode button “BS1” once and reset “Setting Mode 2”.

3.3.5 Check Operation

To prevent any trouble in the period of installation at site, the system is provided with a test operation mode enabling check for incorrect wiring, stop valve left in closed, and judgment of piping length.

CHECK OPERATION FUNCTION

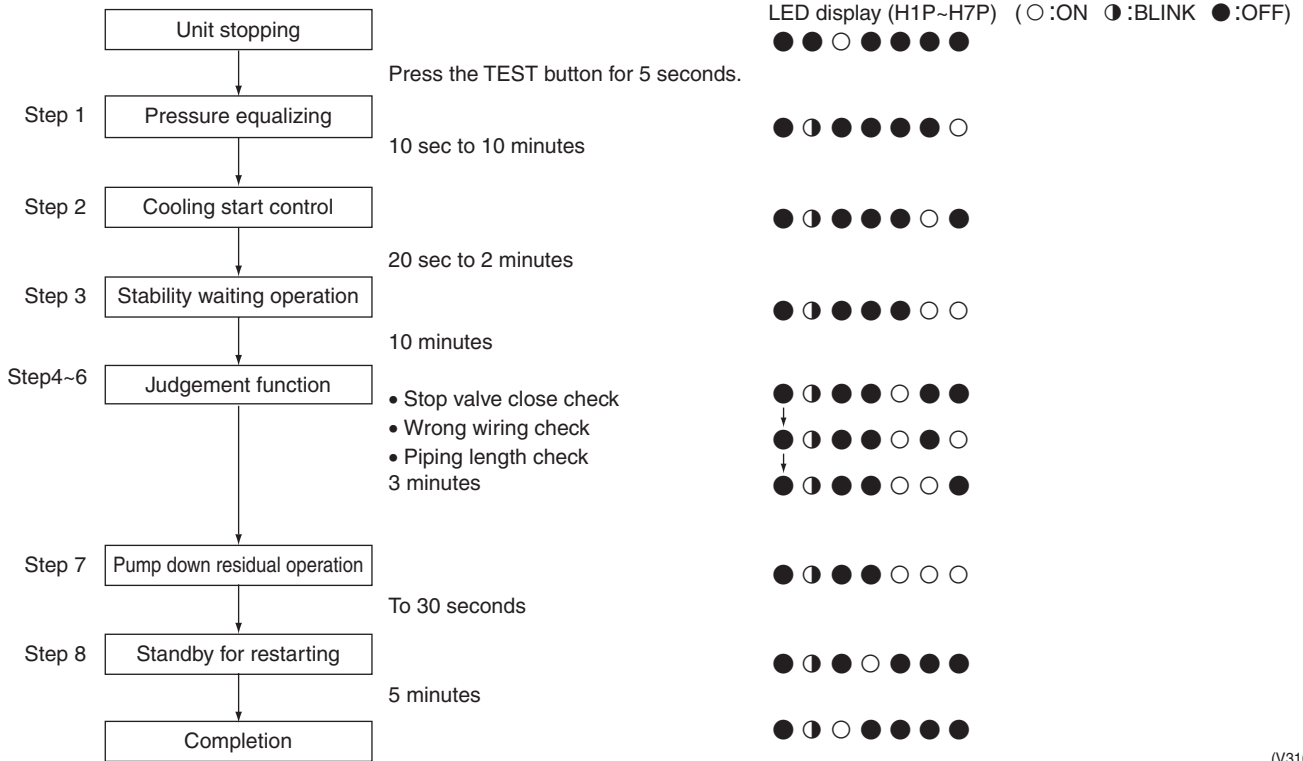

(V3165)

Part 7

Troubleshooting

1. Troubleshooting by Remote Controller	82
1.1 The INSPECTION / TEST Button	82
1.2 Self-Diagnosis by Wired Remote Controller.....	83
1.3 Self-Diagnosis by Wireless Remote Controller	84
1.4 Operation of the Remote Controller's Inspection / Test Operation Button	86
1.5 Remote Controller Service Mode	87
2. List of Malfunction Code	89
3. Malfunction Code Indication by Outdoor Unit PCB	92
4. Troubleshooting by Indication on the Remote Controller	94
4.1 "RD" Indoor Unit: Error of External Protection Device	94
4.2 "RI" Indoor Unit: PC Board Defect	95
4.3 "R3" Indoor Unit: Malfunction of Drain Level Control System (S1L).....	96
4.4 "RE" Indoor Unit: Fan Motor (M1F) Lock, Overload	98
4.5 "RI" Indoor Unit: Malfunction of Swing Flap Motor (MA).....	99
4.6 "RS" Indoor Unit: Malfunction of Moving Part of Electronic Expansion Valve (20E)	101
4.7 "RF" Indoor Unit: Drain Level above Limit	103
4.8 "RJ" Indoor Unit: Malfunction of Capacity Determination Device.....	104
4.9 "CY" Indoor Unit: Malfunction of Thermistor (R2T) for Heat Exchanger	105
4.10 "CS" Indoor Unit: Malfunction of Thermistor (R3T) for Gas Pipes	106
4.11 "CG" Indoor Unit: Malfunction of Thermistor (R1T) for Suction Air	107
4.12 "CU" Indoor Unit: Malfunction of Thermostat Sensor in Remote Controller	108
4.13 "E1" Outdoor Unit: PC Board Defect.....	109
4.14 "E3" Outdoor Unit: Actuation of High Pressure Switch.....	110
4.15 "E4" Outdoor Unit: Actuation of Low Pressure Switch	111
4.16 "E5" Outdoor Unit: Compressor Motor Lock.....	113
4.17 "E7" Outdoor Unit: Malfunction of Outdoor Unit Fan Motor	114
4.18 "E9" Outdoor Unit: Malfunction of Moving Part of Electronic Expansion Valve	116
4.19 "F3" Outdoor Unit: Abnormal Discharge Pipe Temperature	118
4.20 "HS" Outdoor Unit: Malfunction of Thermistor (R1T) for Outdoor Air	119
4.21 "J3" Outdoor Unit: Malfunction of Discharge Pipe Thermistor (R3T)....	120
4.22 "J5" Outdoor Unit: Malfunction of Thermistor (R2T) for Suction Pipe...	121
4.23 "J6" Outdoor Unit: Malfunction of Thermistor (R4T) for Outdoor Unit Heat Exchanger Deicer	122
4.24 "J9" Outdoor Unit: Malfunction of Subcooling Heat Exchanger Gas Pipe Thermistor (R5T)	123
4.25 "JR" Outdoor Unit: Malfunction of High Pressure Sensor	124
4.26 "JL" Outdoor Unit: Malfunction of Low Pressure Sensor	126

4.27	“L4” Outdoor Unit: Malfunction of Inverter Radiating Fin Temperature Rise	127
4.28	“L5” Outdoor Unit: Inverter Compressor Abnormal.....	128
4.29	“L8” Outdoor Unit: Inverter Current Abnormal.....	129
4.30	“L9” Outdoor Unit: Inverter Start up Error	131
4.31	“LC” Outdoor Unit: Malfunction of Transmission between Inverter and Control PC Board.....	132
4.32	“P4” Outdoor Unit: Malfunction of Inverter Radiating Fin Temperature Rise Sensor	134
4.33	“PJ” Outdoor Unit: Faulty Combination of Inverter and Fan Driver	135
4.34	“UD” Outdoor Unit: Low Pressure Drop Due to Refrigerant Shortage or Electronic Expansion Valve Failure	136
4.35	“U2” Outdoor Unit: Power Supply Insufficient or Instantaneous Failure	137
4.36	“U3” Outdoor Unit: Check Operation not Executed.....	139
4.37	“U4” Malfunction of Transmission between Indoor Units and Outdoor Units.....	140
4.38	“U5” Indoor Unit: Malfunction of Transmission between Remote Controller and Indoor Unit.....	142
4.39	“U8” Indoor Unit: Malfunction of Transmission between Main and Sub Remote Controllers	143
4.40	“U9” Indoor Unit: Malfunction of Transmission between Indoor Units and Outdoor Units in the Same System.....	144
4.41	“UR” Improper Combination of Indoor Units and Outdoor Units, Indoor Units and Remote Controller.....	146
4.42	“UC” Address Duplication of Centralized Controller.....	147
4.43	“UE” Malfunction of Transmission between Centralized Controller and Indoor Unit	148
4.44	“UF” System is not Set yet.....	150
4.45	“UH” Malfunction of System, Refrigerant System Address Undefined ..	151
5.	Troubleshooting by Indication on the Central Remote Controller	152
5.1	“M1” PC Board Defect.....	152
5.2	“M8” Malfunction of Transmission between Optional Controllers for Centralized Control	153
5.3	“M9” Improper Combination of Optional Controllers for Centralized Control	154
5.4	“MC” Address Duplication, Improper Setting.....	156
6.	Troubleshooting by Indication on the Unified ON/OFF Controller.....	157
6.1	Operation Lamp Blinks.....	157
6.2	Display “Under Centralized Control” Blinks (Repeats Single Blink)	159
6.3	Display “Under Centralized Control” Blinks (Repeats Double Blink)....	162
7.	Troubleshooting (OP: Schedule Timer)	163
7.1	“UE” Malfunction of Transmission between Centralized Controller and Indoor Unit	163
7.2	“M1” PC Board Defect.....	165
7.3	“M8” Malfunction of Transmission between Optional Controllers for Centralized Control	166

7.4	“ <i>RR</i> ” Improper Combination of Optional Controllers for Centralized Control	167
7.5	“ <i>RL</i> ” Address Duplication, Improper Setting	169
8.	Check	170

1. Troubleshooting by Remote Controller

1.1 The INSPECTION / TEST Button

The following modes can be selected by using the  button on the remote control.

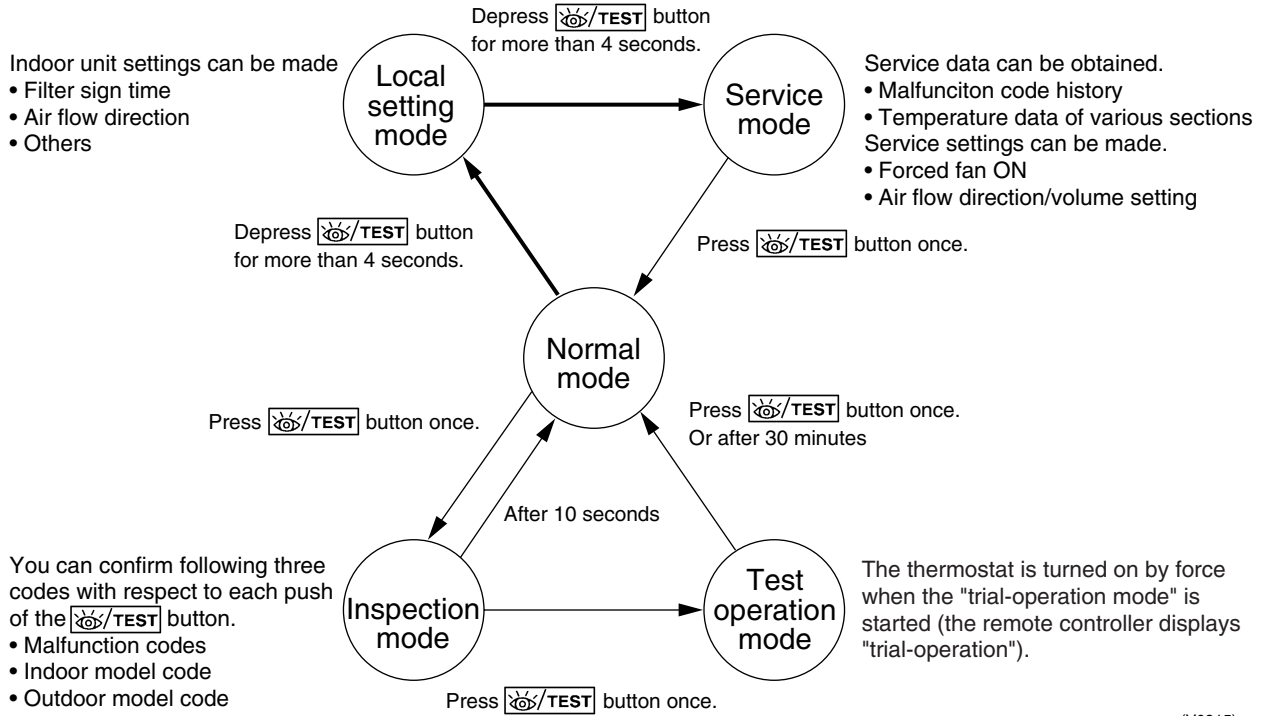

(V0815)

1.2 Self-Diagnosis by Wired Remote Controller

Explanation

If operation stops due to malfunction, the remote controller's operation LED blinks, and malfunction code is displayed. (Even if stop operation is carried out, malfunction contents are displayed when the inspection mode is entered.) The malfunction code enables you to tell what kind of malfunction caused operation to stop.

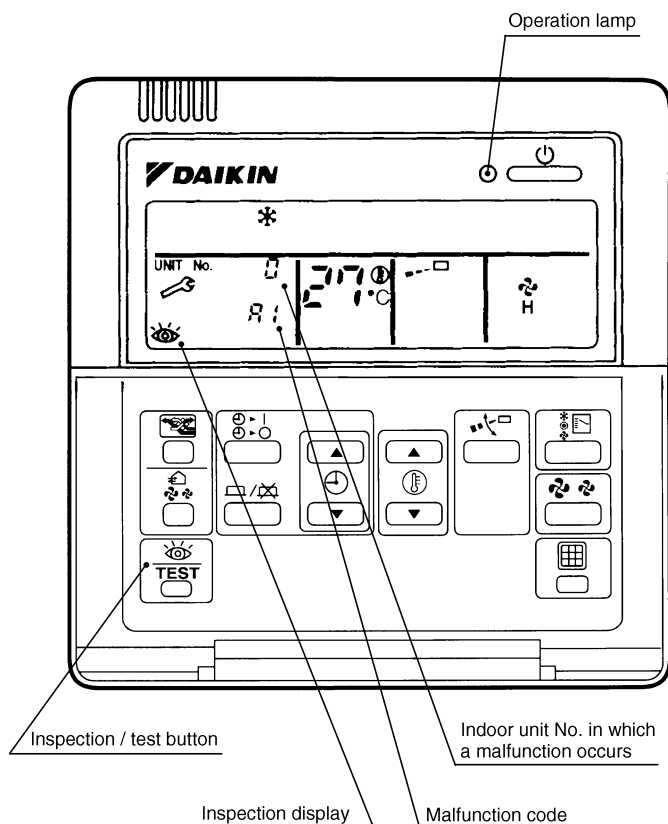

(S2001)

1.3 Self-Diagnosis by Wireless Remote Controller

In the Case of BRC7C Type BRC7E Type

You can confirm the error code as following.

If equipment stops due to a malfunction, the operation indicating LED on the light reception section flashes.

The malfunction code can be determined by following the procedure described below. (The malfunction code is displayed when an operation error has occurred. In normal condition, the malfunction code of the last problem is displayed.)

1. Press the INSPECTION/TEST button to select "Inspection."
The equipment enters the inspection mode. The "Unit" indication lights and the Unit No. display shows flashing "0" indication.
 2. Set the Unit No.
Press the UP or DOWN button and change the Unit No. display until the buzzer (*1) is generated from the indoor unit.
*1 Number of beeps
3 short beeps : Conduct all of the following operations.
1 short beep : Conduct steps 3 and 4.
Continue the operation in step 4 until a buzzer remains ON. The continuous buzzer indicates that the malfunction code is confirmed.
Continuous beep : No abnormality.
 3. Press the MODE selector button.
The left "0" (upper digit) indication of the malfunction code flashes.
 4. Malfunction code upper digit diagnosis
Press the UP or DOWN button and change the malfunction code upper digit until the malfunction code matching buzzer (*2) is generated.
- The upper digit of the code changes as shown below when the UP and DOWN buttons are pressed.

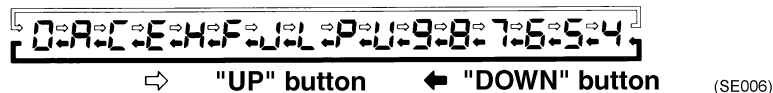

- *2 Number of beeps
Continuous beep : Both upper and lower digits matched. (Malfunction code confirmed)
2 short beeps : Upper digit matched.
1 short beep : Lower digit matched.
5. Press the MODE selector button.
The right "0" (lower digit) indication of the malfunction code flashes.
 6. Malfunction code lower digit diagnosis
Press the UP or DOWN button and change the malfunction code lower digit until the continuous malfunction code matching buzzer (*2) is generated.

- The lower digit of the code changes as shown below when the UP and DOWN buttons are pressed.

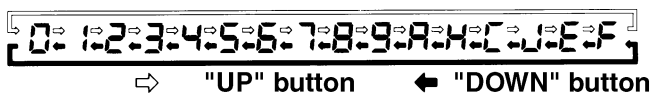

(SE007)

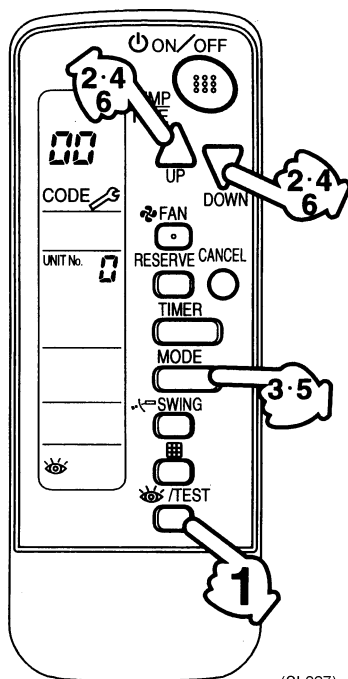

(SL027)

1.4 Operation of the Remote Controller's Inspection / Test Operation Button

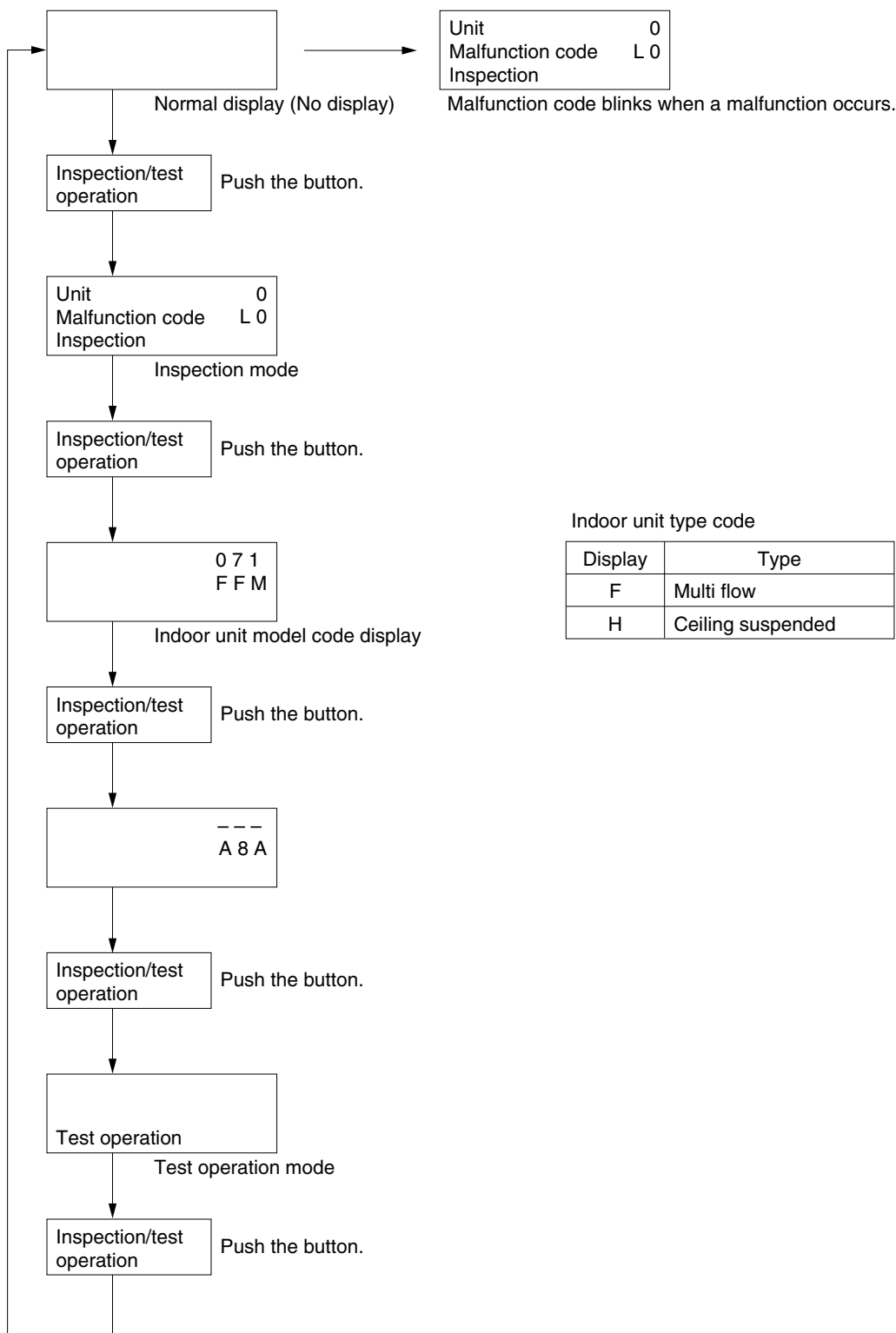

(V3181)

1.5 Remote Controller Service Mode

You can take “service data” and make a “service setting” in the service mode, with operating the  button on the remote controller.

How to Enter the Service Mode

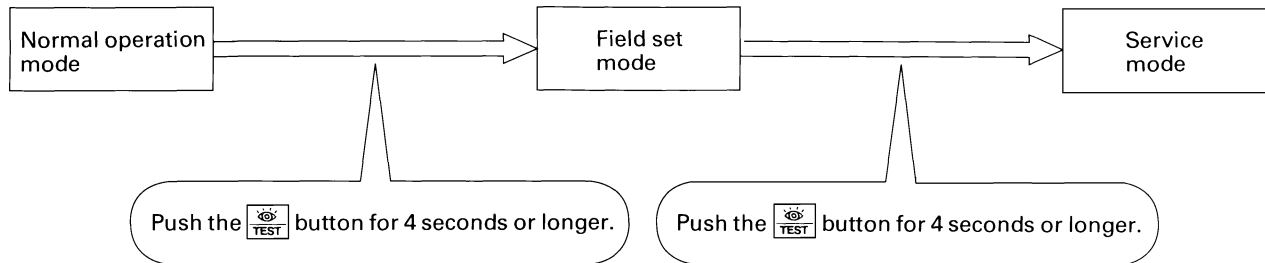



(VF020)

Service Mode Operation Method

1. Select the mode No.

Set the desired mode No. with the  button.
(For wireless remote controller, Mode 43 only can be set.)

2. Select the unit No. (For group control only)

Select the indoor unit No. to be set with the time mode . (For wireless remote controller,  button.)

3. Make the settings required for each mode.

In case of Mode 44, 45, push  button to be able to change setting before setting work.
(LCD “code” blinks.)









For details, refer to the table in next page.

4. Define the setting contents. (Modes 44, 45)

Define by pushing the timer  button.
After defining, LCD “code” changes blinking to ON.

5. Return to the normal operation mode.

Push the  button one time.

Mode No	Function	Contents and operation method	Remote controller display example
40	Malfunction hysteresis display	<p>Display malfunction hysteresis.</p> <p>The history No. can be changed with the  button.</p>	<p>Unit 1 Malfunction code 40</p> <p>2-U4 Malfunction code</p> <p>History No: 1 - 9 1: Latest</p> <p>(VE007)</p>
41	Display of sensor and address data	<p>Display various types of data.</p> <p>Select the data to be displayed with the  button.</p> <p>Sensor data 0: Thermostat sensor in remote controller. 1: Suction 2: Liquid pipe 3: Gas pipe</p> <p>Address data 4: Indoor unit address 5: Outdoor unit address 6: BS unit address 7: Zone control address 8: Cool/heat group address 9: Demand / low noise address</p>	<p>Sensor data display</p> <p>Unit No. Sensor type</p> <p>1 1 2 7 41</p> <p>Temperature °C</p> <p>Address display</p> <p>Unit No. Address type</p> <p>1 8 1 41</p> <p>Address</p> <p>(VE008)</p>
43	Forced fan ON	<p>Manually turn the fan ON by each unit. (When you want to search for the unit No.)</p> <p>By selecting the unit No. with the  button, you can turn the fan of each indoor unit on (forced ON) individually.</p>	<p>Unit 1 43</p> <p>(VE009)</p>
44	Individual setting	<p>Set the fan speed and air flow direction by each unit</p> <p>Select the unit No. with the time mode  button.</p> <p>Set the fan speed with the  button.</p> <p>Set the air flow direction with the  button.</p>	<p>Unit 1 Code 44</p> <p>1 3</p> <p>Fan speed 1: Low 3: High</p> <p>Air flow direction P0 - P4</p> <p>(VE010)</p>
45	Unit No. transfer	<p>Transfer unit No.</p> <p>Select the unit No. with the  button. Set the unit No. after transfer with the  button.</p>	<p>Present unit No.</p> <p>Unit 1 Code 45</p> <p>0 2 Unit No. after transfer</p> <p>(VE011)</p>

2. List of Malfunction Code

○: ON ●: OFF ◐: Blink

	Malfunction code	Operation lamp	Inspection display	Unit No.	Malfunction contents	Page Referred
Indoor Unit	A0	◐	◐	◐	Error of external protection device	94
	A1	◐	◐	◐	PC board defect, E ² PROM defect	95
	A3	◐	◐	◐	Malfunction of drain level control system (S1L)	96
	A6	◐	◐	◐	Fan motor (M1F) lock, overload	98
	A7	○	●	◐	Malfunction of swing flap motor (MA)	99
	A9	◐	◐	◐	Malfunction of moving part of electronic expansion valve (20E)	101
	AF	○	●	◐	Drain level above limit	103
	AJ	◐	◐	◐	Malfunction of capacity setting	104
	C4	◐	◐	◐	Malfunction of thermistor (R2T) for heat exchange (loose connection, disconnection, short circuit, failure)	105
	C5	◐	◐	◐	Malfunction of thermistor (R3T) for gas pipes (loose connection, disconnection, short circuit, failure)	106
	C9	◐	◐	◐	Malfunction of thermistor (R1T) for air inlet (loose connection, disconnection, short circuit, failure)	107
	CJ	○	○	○	Malfunction of thermostat sensor in remote controller	108

 The system operates for malfunction codes indicated in black squares, however, be sure to check and repair.

○: ON ●: OFF ◐: Blink

	Malfunction code	Operation lamp	Inspection display	Unit No.	Malfunction contents	Page Referred
Outdoor Unit	E1	◐	◐	◐	PC board defect, E ² PROM defect	109
	E3	◐	◐	◐	Actuation of high pressure switch	110
	E4	◐	◐	◐	Actuation of low pressure switch	111
	E5	◐	◐	◐	Compressor motor lock	113
	E6	◐	◐	◐	Standard compressor lock or over current	—
	E7	◐	◐	◐	Malfunction of outdoor unit fan motor	114
	E9	◐	◐	◐	Malfunction of moving part of electronic expansion valve (Y1E~3E)	116
	F3	◐	◐	◐	Abnormal discharge pipe temperature	118
	F6	◐	◐	◐	Refrigerant overcharged	—
	H3	○	●	◐	Malfunction of High pressure switch	—
	H4	◐	◐	◐	Actuation of Low pressure switch	—
	H7	◐	◐	◐	Abnormal outdoor fan motor signal	—
	H9	◐	◐	◐	Malfunction of thermistor (R1T) for outdoor air (loose connection, disconnection, short circuit, failure)	119
	J2	◐	◐	◐	Current sensor malfunction	—
	J3	◐	◐	◐	Malfunction of discharge pipe thermistor (R3T) (loose connection, disconnection, short circuit, failure)	120
	J5	◐	◐	◐	Malfunction of thermistor (R2T) for suction pipe (loose connection, disconnection, short circuit, failure)	121
	J6	◐	◐	◐	Malfunction of thermistor (R4T) for heat exchanger (loose connection, disconnection, short circuit, failure)	122
	J9	◐	◐	◐	Malfunction of subcooling heat exchanger gas pipe thermistor (R5T)	123
	JA	◐	◐	◐	Malfunction of high pressure sensor	124
	JC	◐	◐	◐	Malfunction of low pressure sensor	126
	L0	◐	◐	◐	Inverter system error	—
	L4	◐	◐	◐	Malfunction of inverter radiating fin temperature rise	127
	L5	◐	◐	◐	Inverter compressor abnormal	128
	L6	◐	◐	◐	Compressor motor coil grounding on short circuit	—
	L8	◐	◐	◐	Inverter current abnormal	129
	L9	◐	◐	◐	Inverter start up error	131
	LA	◐	◐	◐	Malfunction of power unit	—
	LC	◐	◐	◐	Malfunction of transmission between inverter and control PC board	132
	P1	◐	◐	◐	Inverter over-ripple protection	—
	P4	◐	◐	◐	Malfunction of inverter radiating fin temperature rise sensor	134
PJ	◐	◐	◐	Faulty combination of inverter and fan driver	135	

 The system operates for malfunction codes indicated in black squares, however, be sure to check and repair.

○: ON ●: OFF ◐: Blink

	Malfunction code	Operation lamp	Inspection display	Unit No.	Malfunction contents	Page Referred
System	U0	○	●	◐	Low pressure drop due to refrigerant shortage or electronic expansion valve failure	136
	U1	◐	◐	◐	Reverse phase / open phase	—
	U2	◐	◐	◐	Power supply insufficient or instantaneous failure	137
	U3	◐	◐	◐	Check operation not executed	139
	U4	◐	◐	◐	Malfunction of transmission between indoor units and outdoor units	140
	U5	◐	◐	◐	Malfunction of transmission between remote controller and indoor unit	142
	U5	●	○	●	Failure of remote controller PC board or setting during control by remote controller	—
	U7	◐	◐	◐	Malfunction of transmission between outdoor units	—
	U8	◐	◐	●	Malfunction of transmission between main and sub remote controllers (malfunction of sub remote controller)	143
	U9	◐	◐	◐	Malfunction of transmission between indoor unit and outdoor unit in the same system	144
	UA	◐	◐	◐	Improper combination of indoor and outdoor unit, indoor unit and remote controller	146
	UC	○	○	○	Address duplication of central remote controller	147
	UE	◐	◐	◐	Malfunction of transmission between central remote controller and indoor unit	148
	UF	◐	◐	◐	System is not set yet	150
UH	◐	◐	◐	Malfunction of system, refrigerant system address undefined	151	
Central remote Controller and Schedule Timer	M1	○ or ●	◐	◐	Central remote controller PC board defect	152
	M8	○ or ●	◐	◐	Malfunction of transmission between optional controllers for centralized control	153
	MA	○ or ●	◐	◐	Improper combination of optional controllers for centralized control	154
	MC	○ or ●	◐	◐	Address duplication, improper setting	156

 The system operates for malfunction codes indicated in black squares, however, be sure to check and repair.

3. Malfunction Code Indication by Outdoor Unit PCB

<Monitor mode>

To enter the monitor mode, push the MODE button (BS1) when in "Setting mode 1".

<Selection of setting item>

Push the SET button (BS2) and set the LED display to a setting item.

<Confirmation of malfunction 1>

Push the RETURN button (BS3) once to display "First digit" of malfunction code.

<Confirmation of malfunction 2>

Push the SET button (BS2) once to display "Second digit" of malfunction code.

<Confirmation of malfunction 3>

Push the SET button (BS2) once to display "master or slave1 or slave2" and "malfunction location".

Push the RETURN button (BS3) and switches to the initial status of "Monitor mode".

Detail description on the right.

Contents of malfunction		Malfunction code
Abnormal discharge pressure	HPS activated	E3
Abnormal suction pressure	Abnormal Pe	E4
Compressor lock	Detection of INV compressor lock	E5
Over load, over current, abnormal lock of outdoor unit fan motor	Instantaneous over current of DC fan motor	E7
	Detection of DC fan motor lock	
Malfunction of electronic expansion valve	EV1	E9
	EV2	
Faulty sensor of outdoor air temperature	Faulty Ta sensor	H9
Abnormal discharge pipe temperature	Abnormal Td	F3
Faulty sensor of discharge pipe temperature	Faulty Tdi sensor	J3
Faulty sensor of suction pipe temperature	Faulty Ts sensor	J5
Faulty sensor of heat exchanger temperature	Faulty Tb sensor	J6
Faulty sensor of subcool heat exchanger temperature	Faulty Tsh sensor	J9
Faulty sensor of discharge pressure	Faulty Pc sensor	JA
Faulty sensor of suction pressure	Faulty Pe sensor	JC
DC output over current	Inverter instantaneous over current	L5
Electronic thermal switch	Electronic thermal switch 1	L8
	Electronic thermal switch 2	
	Out-of-step	
	Speed down after startup	
	Lightening detection	
Stall prevention (Limit time)	Stall prevention (Current increasing)	L9
	Stall prevention (Faulty startup)	
	Abnormal wave form in startup	
	Out-of-step	
Transmission error between inverter and outdoor unit	Inverter transmission error	LC
Open phase / Power supply imbalance	Imbalance of inverter power supply voltage	P1
Faulty temperature sensor inside switch box	Faulty thermistor of inverter box	P3
Faulty temperature sensor of inverter radiation fin	Faulty thermistor of inverter fin	P4
Incorrect combination of inverter and fan driver	Incorrect combination of inverter and fan driver	PJ
Gas shortage	Gas shortage alarm	U0
Abnormal power supply voltage	Insufficient inverter voltage	U2
	Inverter open phase (phase T)	
	Charging error of capacitor in inverter main circuit	
Abnormal SP-PAM	Over voltage	
	Over current/Over voltage (Hard detection)	
Abnormal latch circuitry		
No implementation of test-run		U3
Transmission error between indoor and outdoor unit	I/O transmission error	U4
Transmission error of other system	Indoor unit system malfunction in other system or other unit of own system	U9
Erroneous on-site setting	Abnormal connection with excessive number of indoor units	UA
	Conflict of refrigerant type in indoor units	
Faulty system function	Incorrect wiring (Auto address error)	UH
Transmission error in accessory devices, conflict in wiring and piping, no setting for system	Malfunction of multi level converter, abnormality in conflict check	UF

* Push the MODE button (BS1) and returns to "Setting mode 1".

○: ON ●: OFF ◐: Blink

Malfunction code	Confirmation of malfunction 1							Confirmation of malfunction 2							Confirmation of malfunction 3						
	H1P	H2P	H3P	H4P	H5P	H6P	H7P	H1P	H2P	H3P	H4P	H5P	H6P	H7P	H1P	H2P	H3P	H4P	H5P	H6P	H7P
E3	◐			●	●	◐	◐	◐			●	●	◐	◐	◐			●	●	●	●
E4								◐			●	◐	●	●	◐			●	●	●	●
E5								◐			●	◐	●	◐	◐			●	●	●	●
E7								◐			●	◐	◐	◐	◐			●	●	●	◐
E9								◐			◐	●	●	◐	◐			●	●	◐	●
H9	◐			●	◐	●	●	◐			◐	●	●	◐	◐			●	●	●	●
F3	◐			●	◐	●	◐	◐			●	●	◐	◐	◐			●	●	●	●
J3	◐			●	◐	◐	●	◐			●	●	◐	◐	◐			●	●	●	◐
J5								◐			●	◐	●	◐	◐			●	●	●	●
J6								◐			●	◐	◐	●	◐			●	●	●	●
J9								◐			◐	●	●	◐	◐			●	●	●	●
JA								◐			◐	●	◐	●	◐			●	●	●	●
JC								◐			◐	◐	●	●	◐			●	●	●	●
L5	◐			●	◐	◐	◐	◐			●	◐	●	◐	◐			●	●	●	●
L8								◐			◐	●	●	●	◐			●	●	●	●
L9								◐			◐	●	●	◐	◐			●	●	●	●
LC								◐			◐	◐	●	●	◐			●	●	●	●
P1	◐			◐	●	●	●	◐			●	●	●	◐	◐					●	●
P3								◐			●	◐	◐	◐	◐					●	●
P4								◐			●	◐	●	●	◐					●	●
PJ								◐			◐	◐	●	◐	◐					●	●
U0	◐			◐	●	●	◐	◐			●	●	●	●	◐			●	●	●	●
U2								◐			●	●	◐	●	◐			●	●	●	●
U3								◐			●	●	◐	◐	◐			●	●	●	●
U4								◐			●	◐	●	●	◐			●	●	●	●
U9								◐			◐	●	●	●	◐			●	●	●	●
UA								◐			◐	●	◐	●	◐			●	●	●	●
UH								◐			◐	●	◐	◐	◐			●	●	●	●
UF								◐			◐	◐	◐	◐	◐			●	●	●	●

Malfunction code 1st digit display section

Malfunction code 2nd digit display section

Malfunction location

Master	●	●
Slave 1	●	◐
Slave 2	◐	●

(V3168)

4. Troubleshooting by Indication on the Remote Controller

4.1 "A0" Indoor Unit: Error of External Protection Device

Remote Controller Display	A0
Applicable Models	All indoor unit models
Method of Malfunction Detection	Detect open or short circuit between external input terminals in indoor unit.
Malfunction Decision Conditions	When an open circuit occurs between external input terminals with the remote controller set to "external ON/OFF terminal".
Supposed Causes	<ul style="list-style-type: none"> ■ Actuation of external protection device ■ Improper field set ■ Defect of indoor unit PC board

Troubleshooting



Caution

Be sure to turn off power switch before connect or disconnect connector, or parts damage may be occurred.

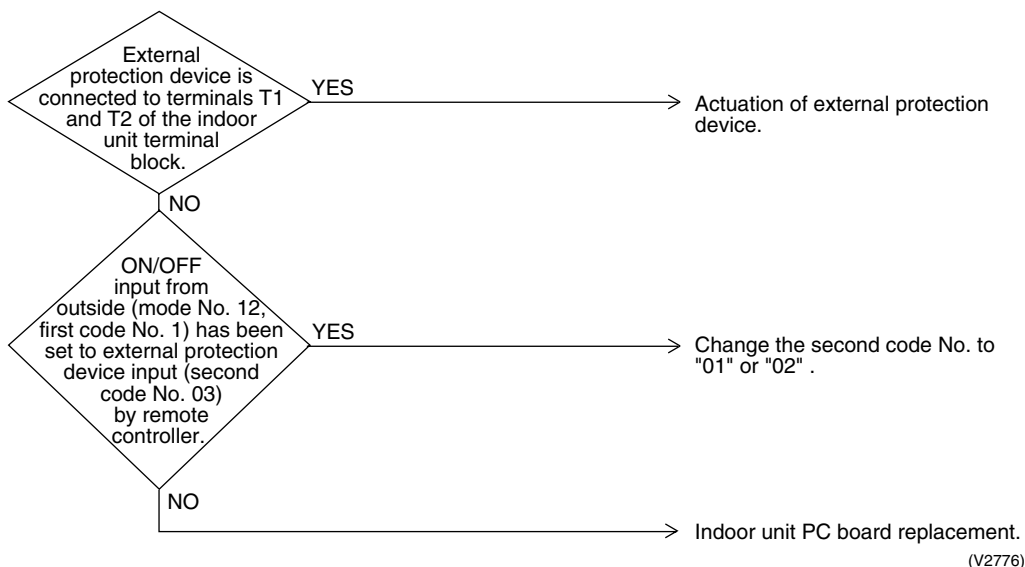

(V2776)

4.2 “A1” Indoor Unit: PC Board Defect

Remote
Controller
Display

A1

Applicable
Models

All indoor unit models

Method of
Malfunction
Detection

Check data from E²PROM.

Malfunction
Decision
Conditions

When data could not be correctly received from the E²PROM
E²PROM : Type of nonvolatile memory. Maintains memory contents even when the power supply is turned off.

Supposed
Causes

- Defect of indoor unit PC board

Troubleshooting



Caution

Be sure to turn off power switch before connect or disconnect connector, or parts damage may be occurred.

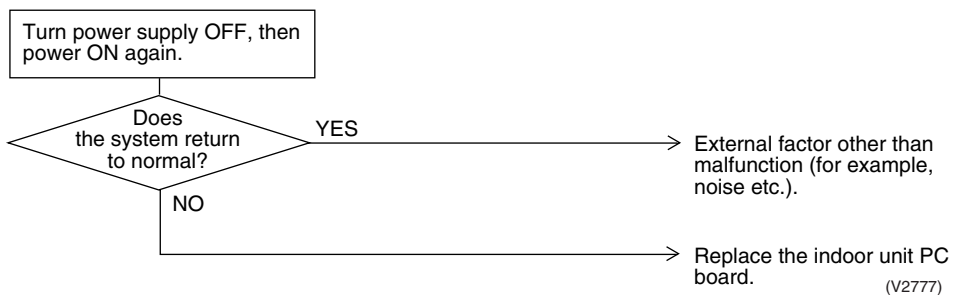

4.3 “A3” Indoor Unit: Malfunction of Drain Level Control System (S1L)

Remote Controller Display	A3
Applicable Models	FCQ, FHQ(Optional)
Method of Malfunction Detection	By float switch OFF detection
Malfunction Decision Conditions	When rise of water level is not a condition and the float switch goes OFF.
Supposed Causes	<ul style="list-style-type: none"> ■ 208~230V power supply is not provided ■ Defect of float switch or short circuit connector ■ Defect of drain pump ■ Drain clogging, upward slope, etc. ■ Defect of indoor unit PC board ■ Loose connection of connector

Troubleshooting



Caution Be sure to turn off power switch before connect or disconnect connector, or parts damage may be occurred.

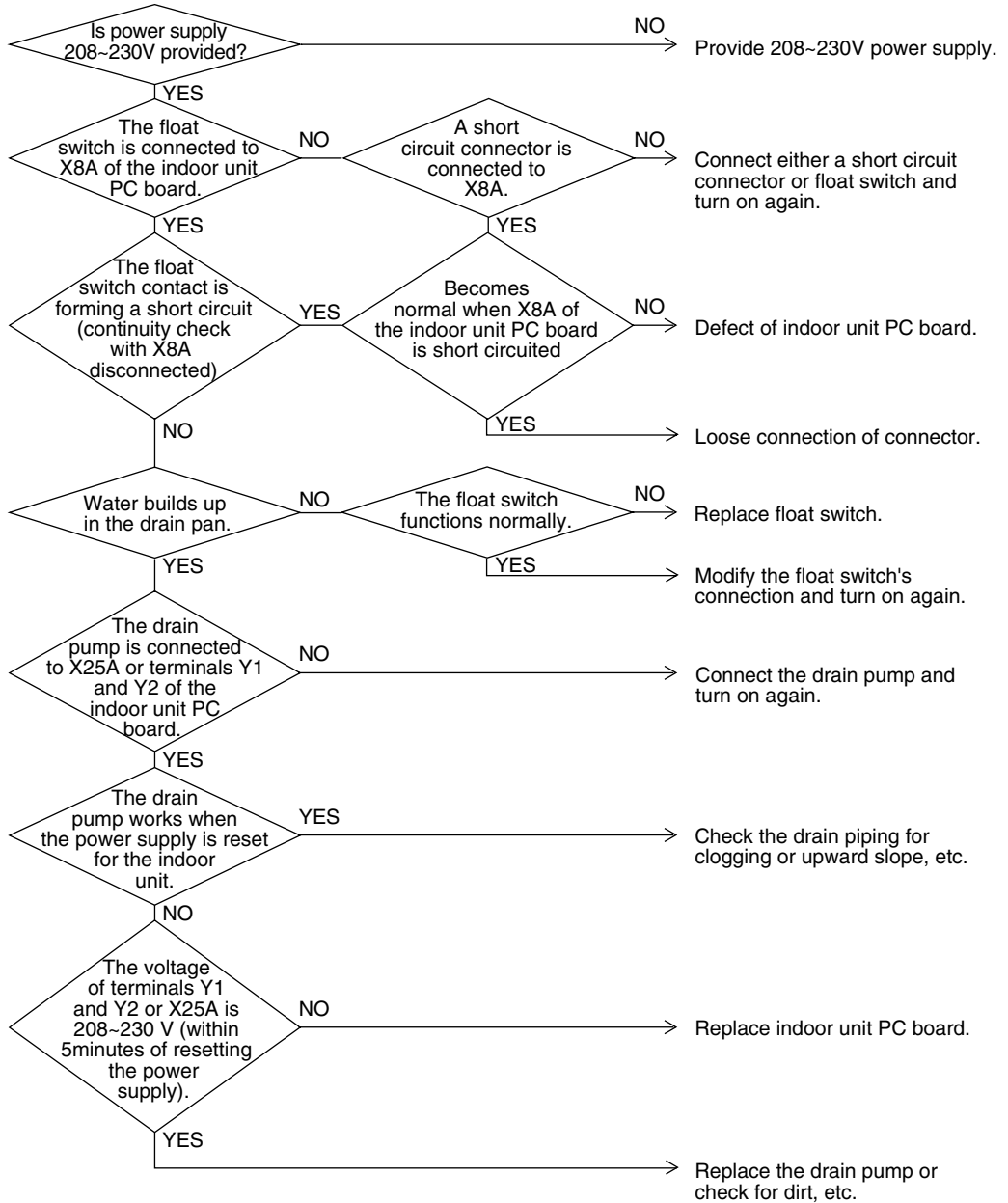

(V2778)

4.4 “A6” Indoor Unit: Fan Motor (M1F) Lock, Overload

Remote
Controller
Display

A6

Applicable
Models

All indoor unit models

Method of
Malfunction
Detection

Detection by failure of signal for detecting number of turns to come from the fan motor

Malfunction
Decision
Conditions

When number of turns can't be detected even when output voltage to the fan is maximum

Supposed
Causes

- Fan motor lock
- Disconnected or faulty wiring between fan motor and PC board

Troubleshooting



Caution

Be sure to turn off power switch before connect or disconnect connector, or parts damage may be occurred.

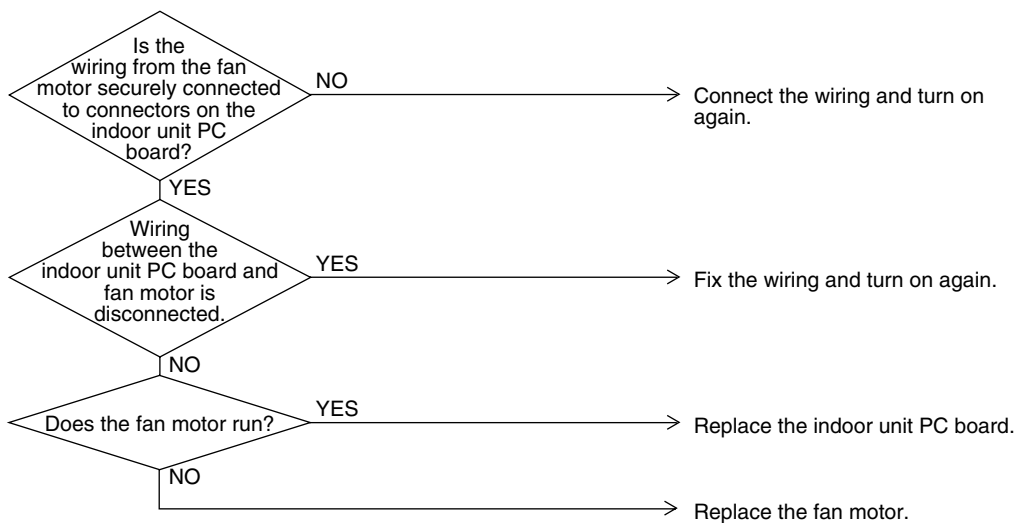

(V2779)

4.5 “A7” Indoor Unit: Malfunction of Swing Flap Motor (MA)

Remote
Controller
Display

A7

Applicable
Models

FHQ

Method of
Malfunction
Detection

Utilizes ON/OFF of the limit switch when the motor turns.

Malfunction
Decision
Conditions

When ON/OFF of the microswitch for positioning cannot be reversed even though the swing flap motor is energized for a specified amount of time (about 30 seconds).

Supposed
Causes

- Defect of swing motor
- Defect of connection cable (power supply and limit switch)
- Defect of air flow direction adjusting flap-cam
- Defect of indoor unit PC board

Troubleshooting



Caution Be sure to turn off power switch before connect or disconnect connector, or parts damage may be occurred.

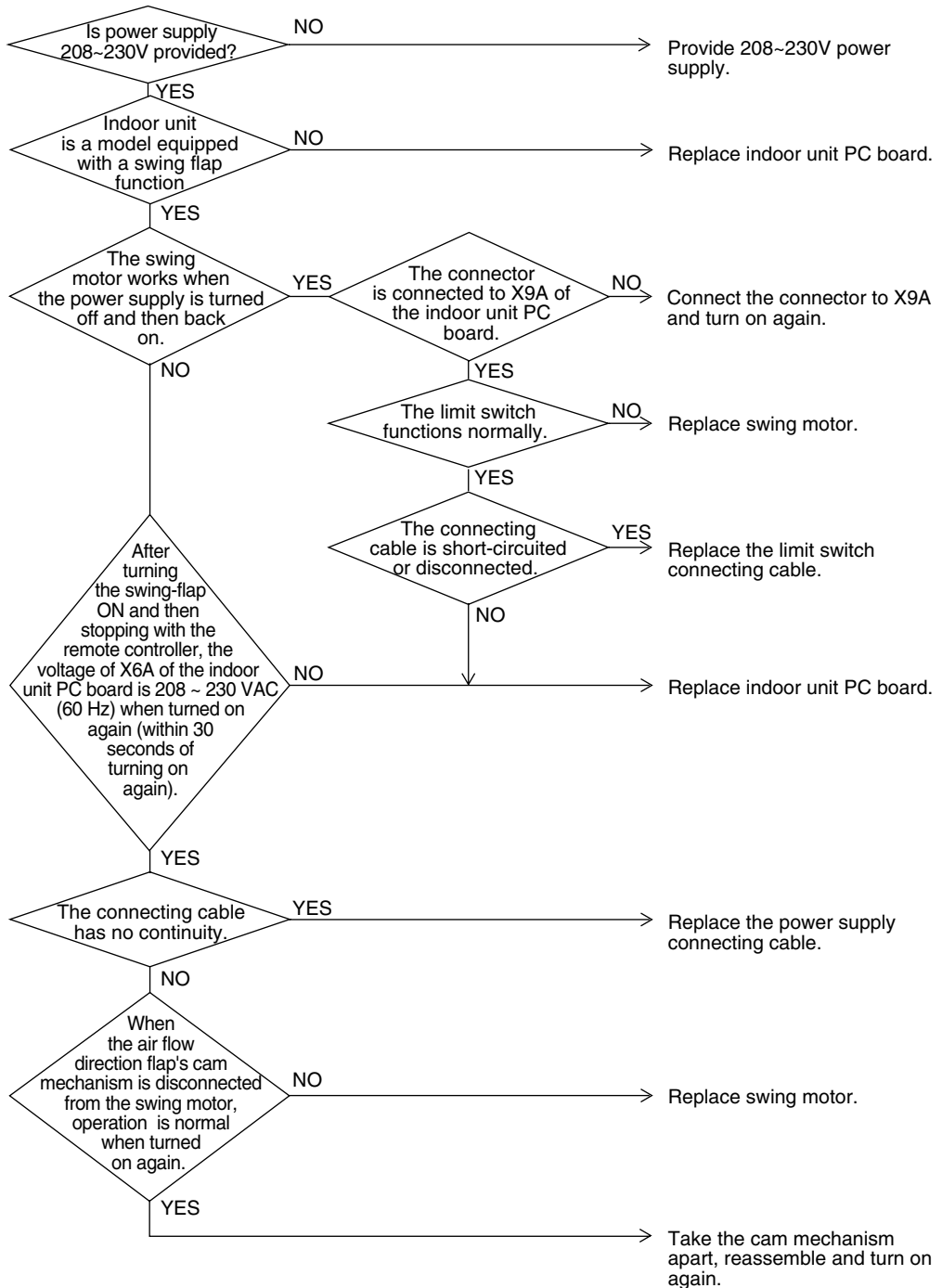

(V2780)

4.6 “A9” Indoor Unit: Malfunction of Moving Part of Electronic Expansion Valve (20E)

Remote Controller Display

A9

Applicable Models

All indoor unit models

Method of Malfunction Detection

Use a microcomputer to check the electronic expansion valve for coil conditions.

Malfunction Decision Conditions

When the pin input of the electronic expansion valve is not normal while in the initialization of the microcomputer.

Supposed Causes

- Malfunction of moving part of electronic expansion valve
- Defect of indoor unit PC board
- Defect of connecting cable

Troubleshooting



Caution

Be sure to turn off power switch before connect or disconnect connector, or parts damage may be occurred.

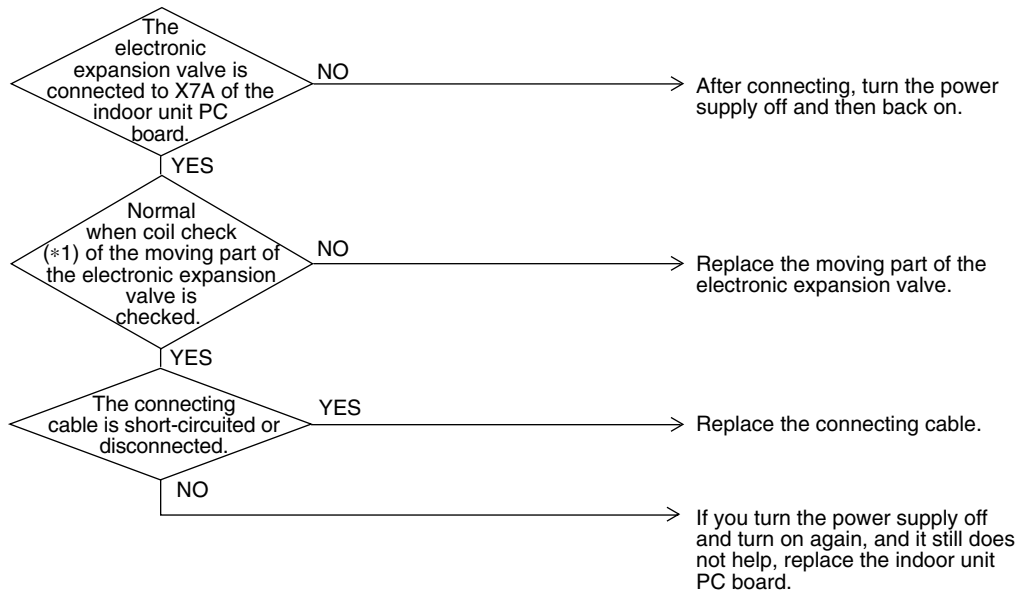

(V2781)

*1: Coil check method for the moving part of the electronic expansion valve
 Disconnect the electronic expansion valve from the PC board and check the continuity between the connector pins.

(Normal)

Pin No.	1. White	2. Yellow	3. Orange	4. Blue	5. Red	6. Brown
1. White		x	⊙ Approx. 300Ω	x	○ Approx. 150Ω	x
2. Yellow			x	⊙ Approx. 300Ω	x	○ Approx. 150Ω
3. Orange				x	○ Approx. 150Ω	x
4. Blue					x	○ Approx. 150Ω
5. Red						x
6. Brown						

⊙ : Continuity Approx. 300Ω

○ : Continuity Approx. 150Ω

x : No continuity

4.7 “AF” Indoor Unit: Drain Level above Limit

Remote Controller Display	<i>AF</i>
Applicable Models	FCQ
Method of Malfunction Detection	Water leakage is detected based on float switch ON/OFF operation while the compressor is in non-operation.
Malfunction Decision Conditions	When the float switch changes from ON to OFF while the compressor is in non-operation.
Supposed Causes	<ul style="list-style-type: none"> ■ Humidifier unit (optional accessory) leaking ■ Defect of drain pipe (upward slope, etc.) ■ Defect of indoor unit PC board

Troubleshooting



Caution

Be sure to turn off power switch before connect or disconnect connector, or parts damage may be occurred.

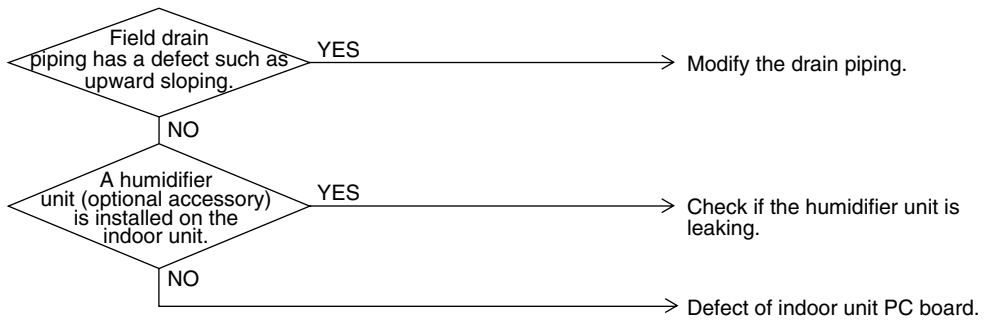

(V2782)

4.8 “AU” Indoor Unit: Malfunction of Capacity Determination Device

Remote controller display

AU

Applicable Models

All indoor unit models

Method of Malfunction Detection

Capacity is determined according to resistance of the capacity setting adaptor and the memory inside the IC memory on the indoor unit PC board, and whether the value is normal or abnormal is determined.

Malfunction Decision Conditions

Operation and:
 1. When the capacity code is not contained in the PC board's memory, and the capacity setting adaptor is not connected.
 2. When a capacity that doesn't exist for that unit is set.

Supposed Causes

- You have forgotten to install the capacity setting adaptor.
- Defect of indoor unit PC board

Troubleshooting



Caution

Be sure to turn off power switch before connect or disconnect connector, or parts damage may be occurred.



(V2783)

4.9 “C4” Indoor Unit: Malfunction of Thermistor (R2T) for Heat Exchanger

Remote Controller Display

C4

Applicable Models

All indoor unit models

Method of Malfunction Detection

Malfunction detection is carried out by temperature detected by heat exchanger thermistor.

Malfunction Decision Conditions

When the heat exchanger thermistor becomes disconnected or shorted while the unit is running.

Supposed Causes

- Defect of thermistor (R2T) for liquid pipe
- Defect of indoor unit PC board

Troubleshooting



Caution

Be sure to turn off power switch before connect or disconnect connector, or parts damage may be occurred.

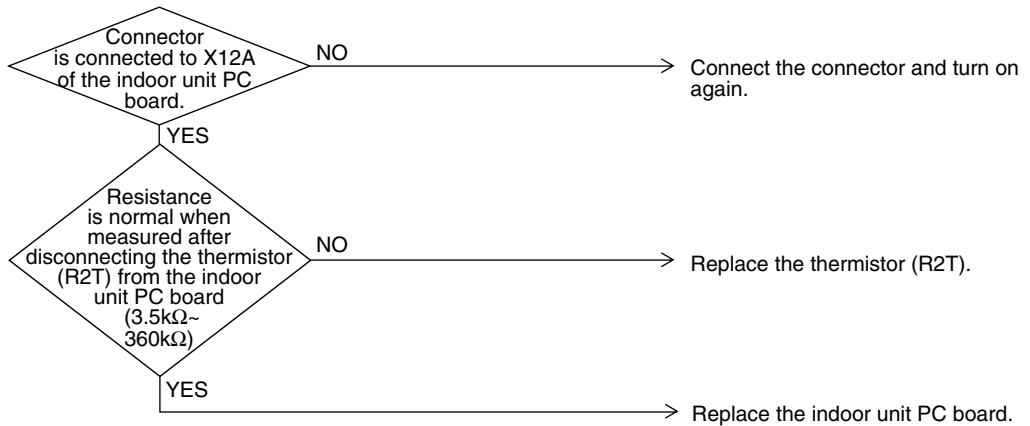

(V2784)



* Refer to “Thermistor Resistance / Temperature Characteristics” table on P179.

4.10 “E5” Indoor Unit: Malfunction of Thermistor (R3T) for Gas Pipes

Remote Controller Display	E5
Applicable Models	All indoor unit models
Method of Malfunction Detection	Malfunction detection is carried out by temperature detected by gas pipe thermistor.
Malfunction Decision Conditions	When the gas pipe thermistor becomes disconnected or shorted while the unit is running.
Supposed Causes	<ul style="list-style-type: none"> ■ Defect of indoor unit thermistor (R3T) for gas pipe ■ Defect of indoor unit PC board

Troubleshooting



Caution

Be sure to turn off power switch before connect or disconnect connector, or parts damage may be occurred.

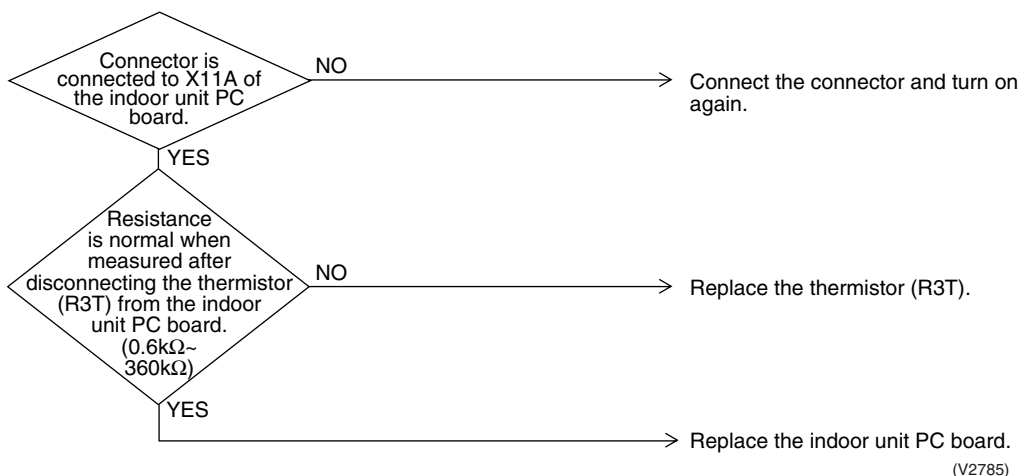

(V2785)



* Refer to “Thermistor Resistance / Temperature Characteristics” table on P179.

4.11 “E9” Indoor Unit: Malfunction of Thermistor (R1T) for Suction Air

Remote Controller Display

E9

Applicable Models

All indoor unit models

Method of Malfunction Detection

Malfunction detection is carried out by temperature detected by suction air temperature thermistor.

Malfunction Decision Conditions

When the suction air temperature thermistor becomes disconnected or shorted while the unit is running.

Supposed Causes

- Defect of indoor unit thermistor (R1T) for air inlet
- Defect of indoor unit PC board

Troubleshooting



Caution

Be sure to turn off power switch before connect or disconnect connector, or parts damage may be occurred.

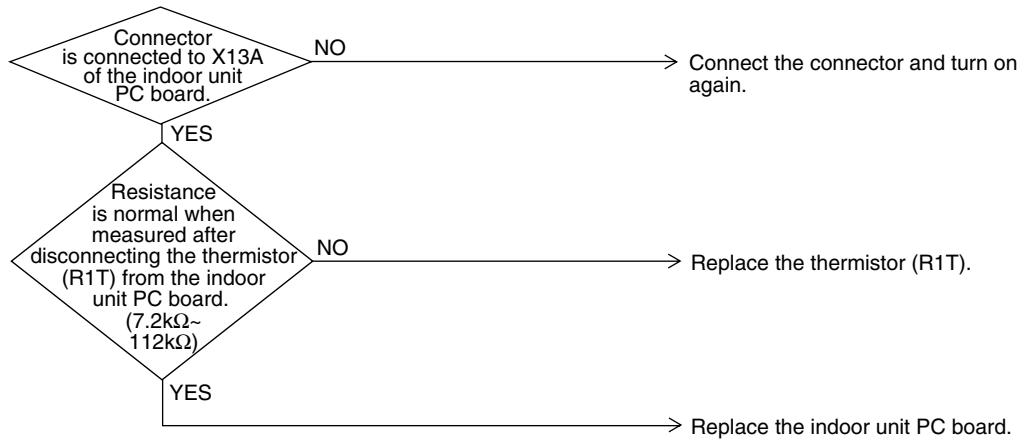

(V2786)



* Refer to “Thermistor Resistance / Temperature Characteristics” table on P179.

4.12 “CJ” Indoor Unit: Malfunction of Thermostat Sensor in Remote Controller

Remote Controller Display	CJ
Applicable Models	All indoor unit models
Method of Malfunction Detection	Malfunction detection is carried out by temperature detected by remote controller air temperature thermistor. (Note:)
Malfunction Decision Conditions	When the remote controller air temperature thermistor becomes disconnected or shorted while the unit is running.
Supposed Causes	<ul style="list-style-type: none"> ■ Defect of remote controller thermistor ■ Defect of remote controller PC board

Troubleshooting

 **Caution** Be sure to turn off power switch before connect or disconnect connector, or parts damage may be occurred.

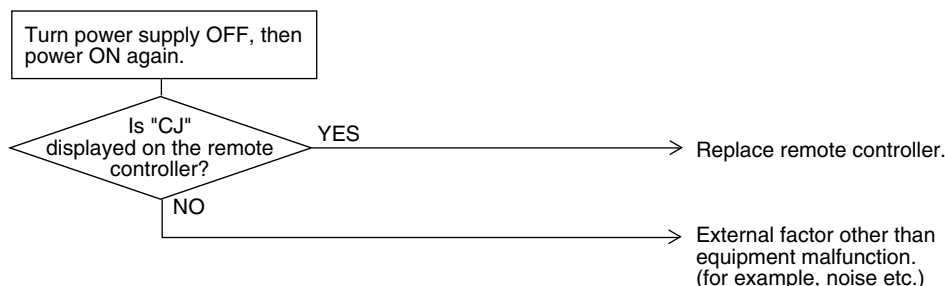

(V2787)

 **Note:** In case of remote controller thermistor malfunction, unit is still operable by suction air thermistor on indoor unit.



* Refer to “Thermistor Resistance / Temperature Characteristics” table on P179.

4.13 “E1” Outdoor Unit: PC Board Defect

Remote
Controller
Display

E1

Applicable
Models

All outdoor unit models

Method of
Malfunction
Detection

Check data from E²PROM

Malfunction
Decision
Conditions

When data could not be correctly received from the E²PROM
E²PROM : Type of nonvolatile memory. Maintains memory contents even when the power supply is turned off.

Supposed
Causes

- Defect of outdoor unit PC board (A1P)

Troubleshooting



Caution

Be sure to turn off power switch before connect or disconnect connector, or parts damage may be occurred.

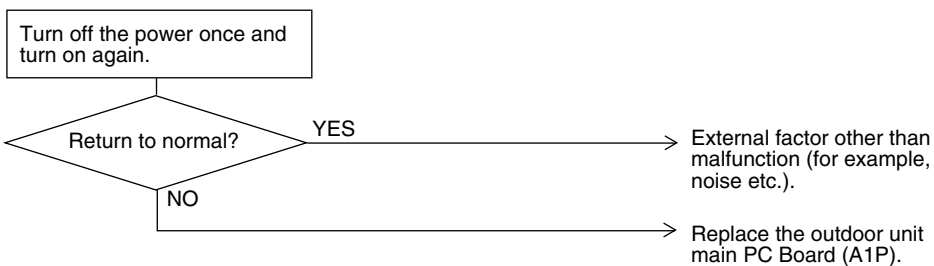

(V3064)

4.14 “E3” Outdoor Unit: Actuation of High Pressure Switch

Remote Controller Display



Applicable Models

All outdoor unit models

Method of Malfunction Detection

Abnormality is detected when the contact of the high pressure protection switch opens.

Malfunction Decision Conditions

Error is generated when the HPS activation count reaches the number specific to the operation mode.

Supposed Causes

- Actuation of outdoor unit high pressure switch
- Defect of High pressure switch
- Defect of outdoor unit PC board (A2P)
- Instantaneous power failure
- Faulty high pressure sensor

Troubleshooting



Caution

Be sure to turn off power switch before connect or disconnect connector, or parts damage may be occurred.

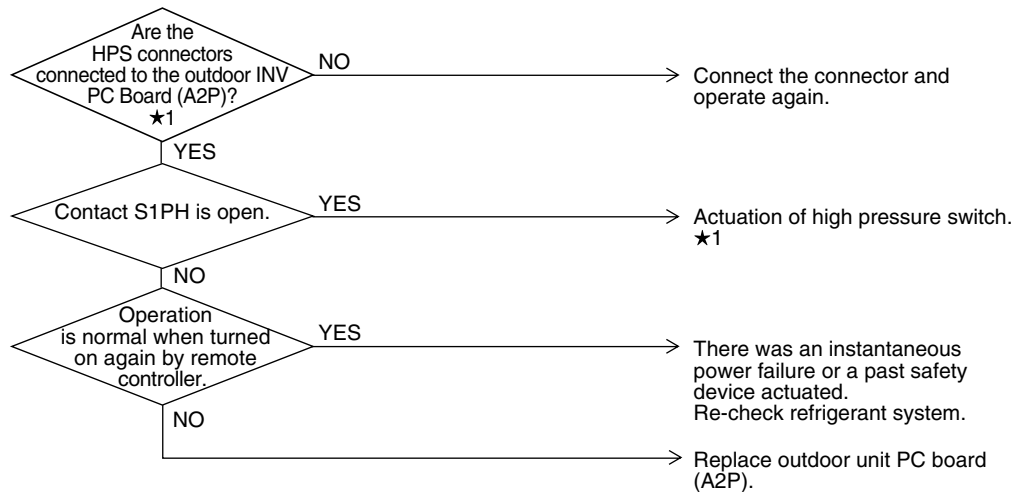

(V3065)

★1: Actuation of high pressure switch (HPS)

- Is the outdoor unit heat exchanger dirty?
- Defect of outdoor fan
- Is the refrigerant over-charged?
- Faulty high pressure sensor

4.15 “E4” Outdoor Unit: Actuation of Low Pressure Switch

Remote
Controller
Display

E4

Applicable
Models

All outdoor unit models

Method of
Malfunction
Detection

Abnormality is detected by pressure value with low pressure sensor.

Malfunction
Decision
Conditions

Error is generated when the low pressure is dropped under specific pressure.

Supposed
Causes

- Abnormal drop of low pressure
- Defect of low pressure sensor
- Defect of outdoor unit PC board
- Stop valve is not opened.

Troubleshooting



Caution

Be sure to turn off power switch before connect or disconnect connector, or parts damage may be occurred.

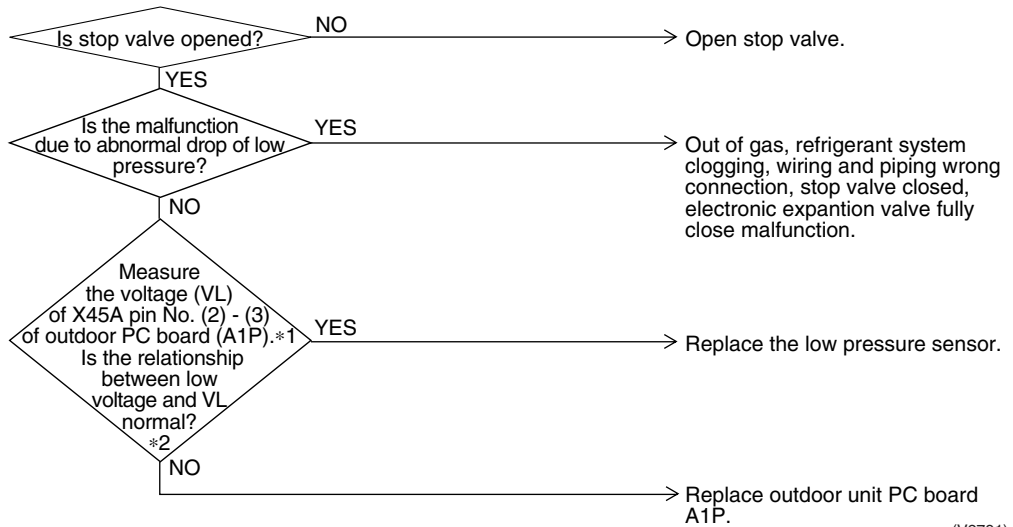

(V2791)

*1: Voltage measurement point

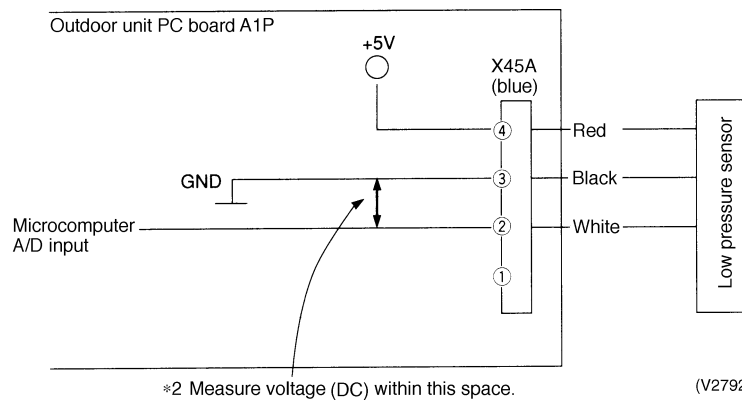

*2 Measure voltage (DC) within this space.

(V2792)



*2: Refer to “Pressure Sensor”, pressure / voltage characteristics table on P181.

4.16 “E5” Outdoor Unit: Compressor Motor Lock

Remote
Controller
Display

E5

Applicable
Models

All outdoor unit models

Method of
Malfunction
Detection

Inverter PC board takes the position signal from UVWN line connected between the inverter and compressor, and detects the position signal pattern.

Malfunction
Decision
Conditions

The position signal with 3 times cycle as imposed frequency is detected when compressor motor operates normally, but 2 times cycle when compressor motor locks. When the position signal in 2 times cycle is detected.

Supposed
Causes

- Compressor lock
- High differential pressure (73 psi or more)
- Incorrect UVWN wiring
- Faulty inverter PC board
- Stop valve is left in closed.

Troubleshooting



Caution

Be sure to turn off power switch before connect or disconnect connector, or parts damage may be occurred.

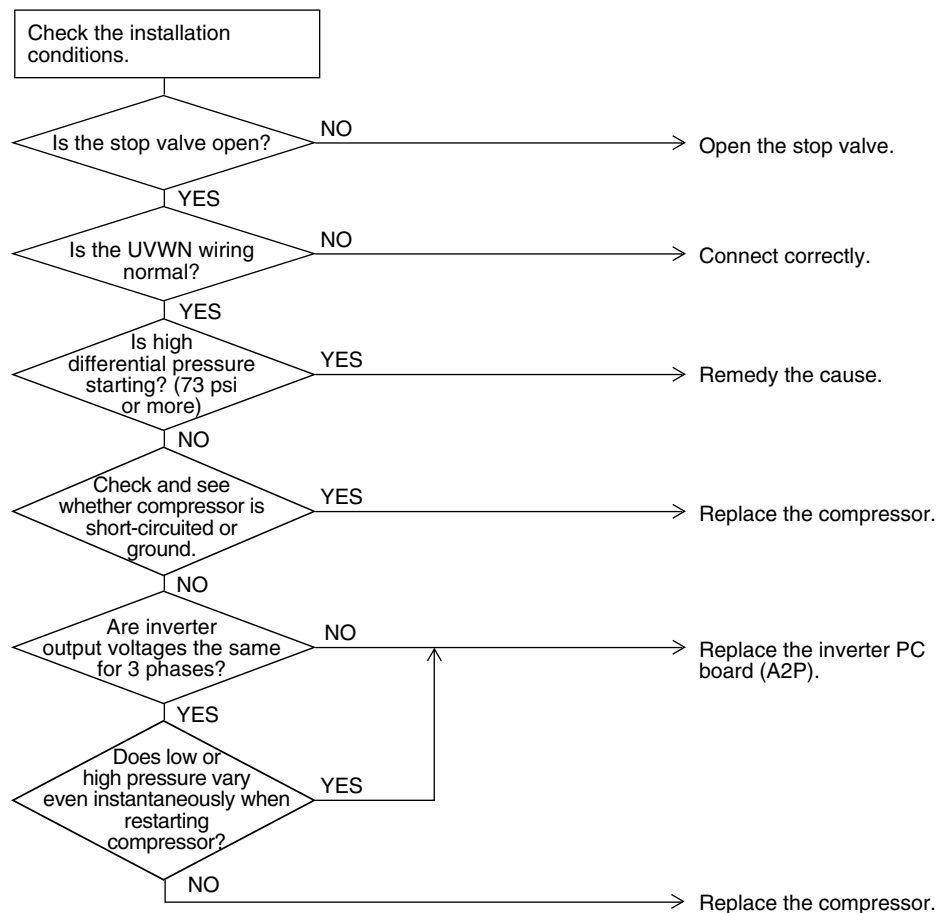

(V2793)

4.17 “E7” Outdoor Unit: Malfunction of Outdoor Unit Fan Motor

Remote
Controller
Display

E7

Applicable
Models

All outdoor unit models

Method of
Malfunction
Detection

Malfunction of fan motor system is detected according to the fan speed detected by hall IC when the fan motor runs.

Malfunction
Decision
Conditions

- When the fan runs with speed less than a specified one for 14.5 seconds or more when the fan motor running conditions are met
- When malfunction is generated 4 times, the system shuts down.

Supposed
Causes

- Malfunction of fan motor
- The harness connector between fan motor and PC board is left in disconnected, or faulty connector
- Fan does not run due to foreign matters tangled
- Clearing condition: Operate for 5 minutes (normal)

Troubleshooting

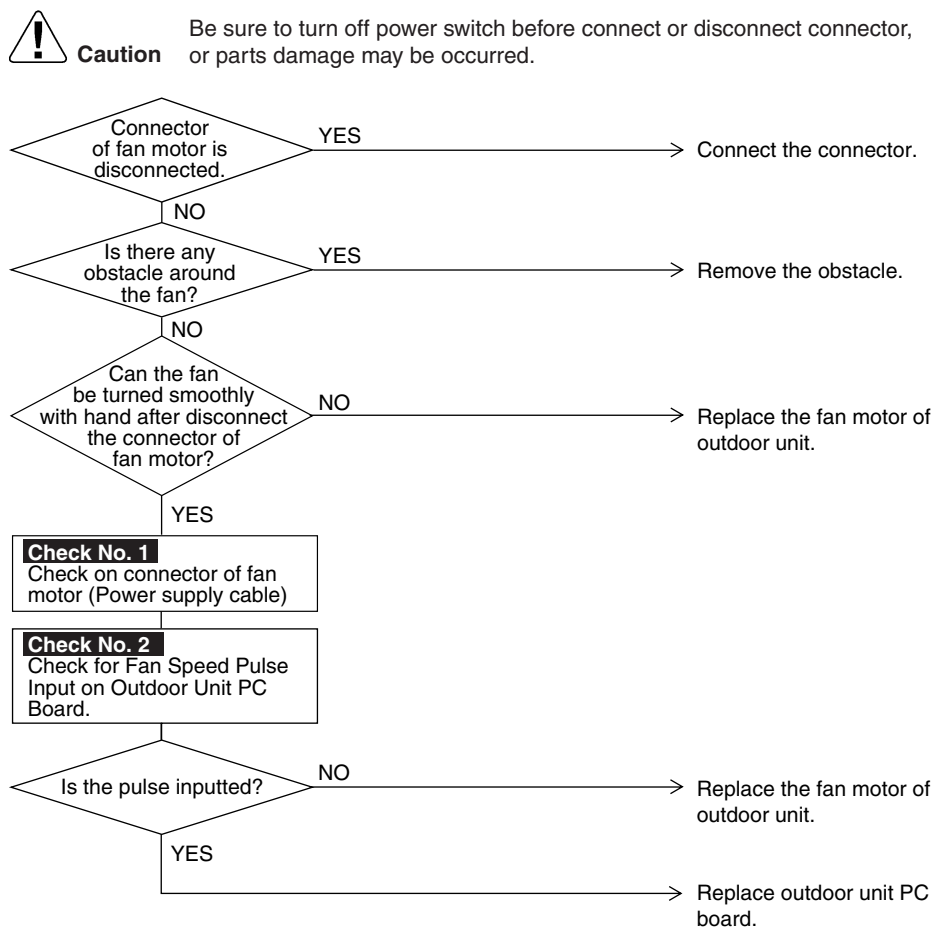

(V3077)



Check No. 1: Refer to P170.
Check No. 2: Refer to P171.

4.18 “E9” Outdoor Unit: Malfunction of Moving Part of Electronic Expansion Valve

Remote Controller Display	E9
Applicable Models	All outdoor unit models
Method of Malfunction Detection	Check disconnection of connector Check continuity of expansion valve coil
Malfunction Decision Conditions	Error is generated under no common power supply when the power is on.
Supposed Causes	<ul style="list-style-type: none"> ■ Defect of moving part of electronic expansion valve ■ Defect of outdoor unit PC board (A1P)

Troubleshooting

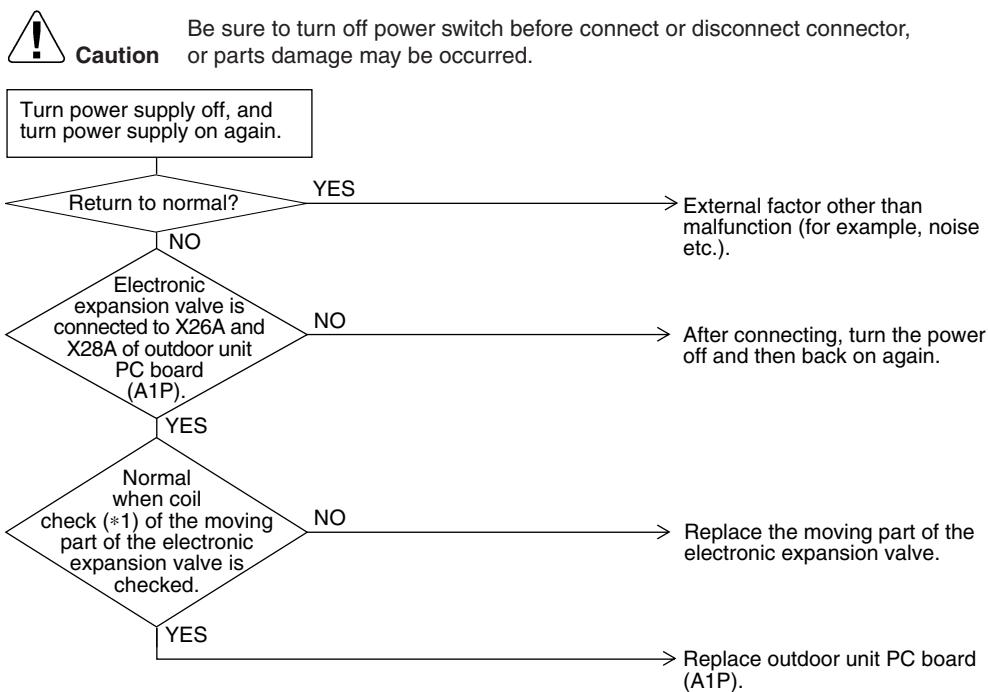

(V3067)

*1 Coil check method for the moving part of the electronic expansion valve
 Disconnect the electronic expansion valve from the PC board and check the continuity between the connector pins.

(Normal)

Pin No.	1. White	2. Yellow	3. Orange	4. Blue	5. Red	6. Brown
1. White		x	⊙ Approx. 300Ω	x	○ Approx. 150Ω	x
2. Yellow			x	⊙ Approx. 300Ω	x	○ Approx. 150Ω
3. Orange				x	○ Approx. 150Ω	x
4. Blue					x	○ Approx. 150Ω
5. Red						x
6. Brown						

⊙ : Continuity Approx. 300Ω

○ : Continuity Approx. 150Ω

x : No continuity

4.19 “F3” Outdoor Unit: Abnormal Discharge Pipe Temperature

Remote Controller Display	F3
Applicable Models	All outdoor unit models
Method of Malfunction Detection	Abnormality is detected according to the temperature detected by the discharge pipe temperature sensor.
Malfunction Decision Conditions	<ul style="list-style-type: none"> ■ When the discharge pipe temperature rises to an abnormally high level ■ When the discharge pipe temperature rises suddenly
Supposed Causes	<ul style="list-style-type: none"> ■ Faulty discharge pipe temperature ■ Faulty connection of discharge pipe thermistor ■ Faulty outdoor unit PC board

Troubleshooting

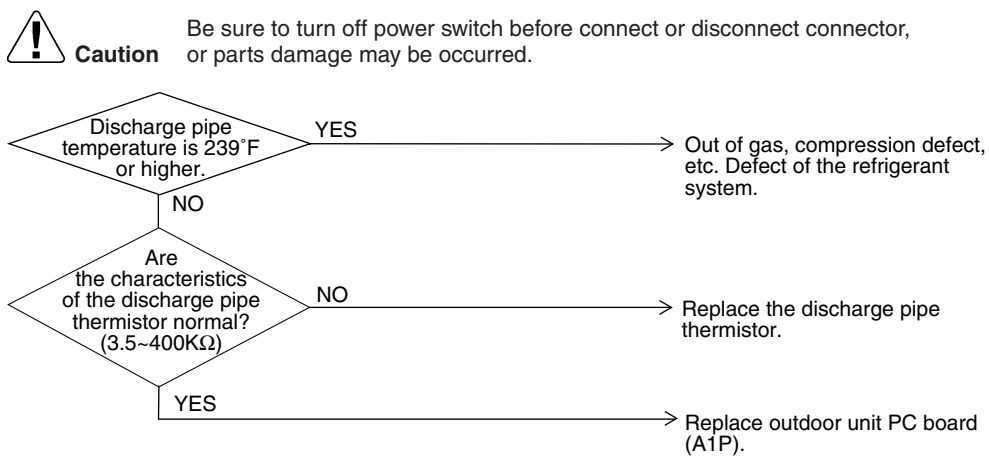

(V3182)



* Refer to “Thermistor Resistance / Temperature Characteristics” table on P179.

4.20 “H9” Outdoor Unit: Malfunction of Thermistor (R1T) for Outdoor Air

Remote Controller Display

H9

Applicable Models

All outdoor unit models

Method of Malfunction Detection

The abnormal detection is based on current detected by current sensor.

Malfunction Decision Conditions

When the outside air temperature sensor has short circuit or open circuit.

Supposed Causes

- Defect of thermistor (R1T) for outdoor air
- Defect of outdoor unit PC board (A1P)

Troubleshooting



Caution

Be sure to turn off power switch before connect or disconnect connector, or parts damage may be occurred.

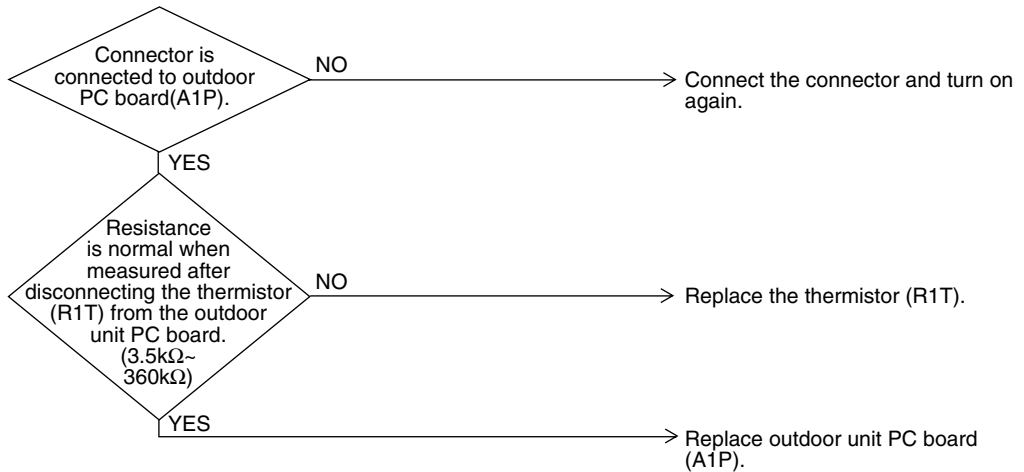

(V3070)

The alarm indicator is displayed when the fan only is being used also.



* Refer to “Thermistor Resistance / Temperature Characteristics” table on P179.

4.21 “J3” Outdoor Unit: Malfunction of Discharge Pipe Thermistor (R3T)

Remote Controller Display	J3
Applicable Models	All outdoor unit models
Method of Malfunction Detection	Malfunction is detected from the temperature detected by discharge pipe temperature thermistor.
Malfunction Decision Conditions	When a short circuit or an open circuit in the discharge pipe temperature thermistor is detected.
Supposed Causes	<ul style="list-style-type: none"> ■ Defect of thermistor (R3T) for outdoor unit discharge pipe ■ Defect of outdoor unit PC board (A1P)

Troubleshooting



Caution

Be sure to turn off power switch before connect or disconnect connector, or parts damage may be occurred.

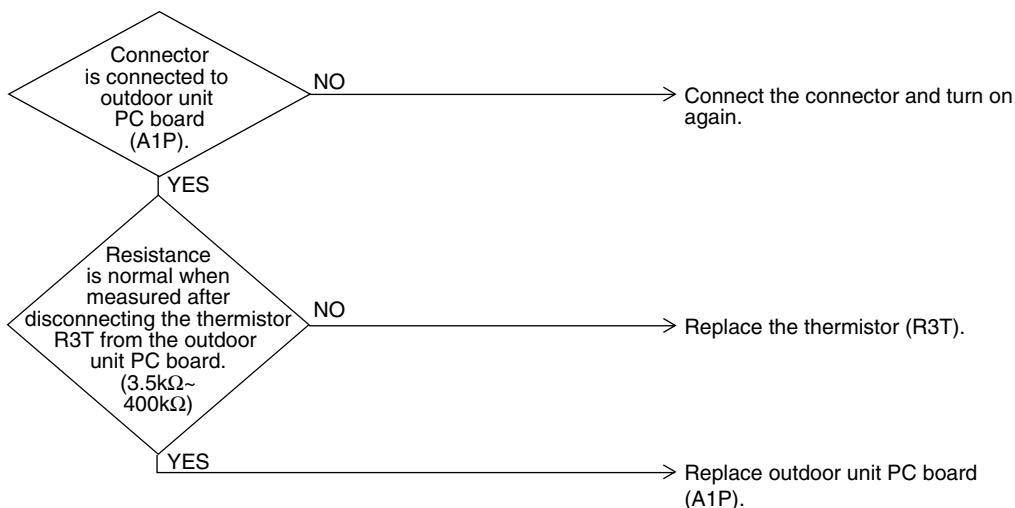

(V3072)



* Refer to “Thermistor Resistance / Temperature Characteristics” table on P180.

4.22 “J5” Outdoor Unit: Malfunction of Thermistor (R2T) for Suction Pipe

Remote Controller Display

J5

Applicable Models

All outdoor unit models

Method of Malfunction Detection

Malfunction is detected from the temperature detected by the suction pipe temperature thermistor.

Malfunction Decision Conditions

When a short circuit or an open circuit in the suction pipe temperature thermistor is detected.

Supposed Causes

- Defect of thermistor (R2T) for outdoor unit suction pipe
- Defect of outdoor unit PC board (A1P)

Troubleshooting



Caution

Be sure to turn off power switch before connect or disconnect connector, or parts damage may be occurred.

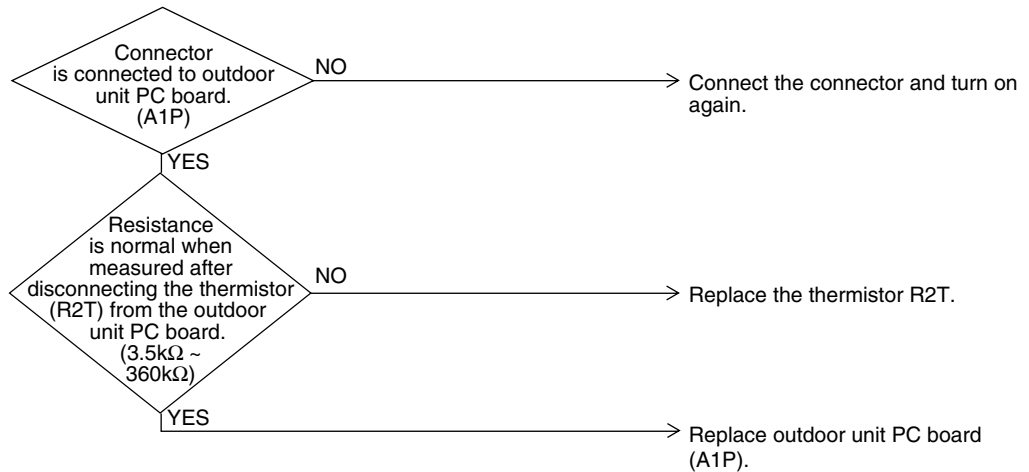

(V3073)



* Refer to “Thermistor Resistance / Temperature Characteristics” table on P179.

4.23 “J5” Outdoor Unit: Malfunction of Thermistor (R4T) for Outdoor Unit Heat Exchanger Deicer

Remote Controller Display	J5
Applicable Models	All outdoor unit models
Method of Malfunction Detection	Malfunction is detected from the temperature detected by the heat exchanger thermistor.
Malfunction Decision Conditions	When a short circuit or an open circuit in the heat exchange thermistor is detected.
Supposed Causes	<ul style="list-style-type: none"> ■ Defect of thermistor (R4T) for outdoor unit heat exchanger ■ Defect of outdoor unit PC board (A1P)

Troubleshooting



Caution

Be sure to turn off power switch before connect or disconnect connector, or parts damage may be occurred.

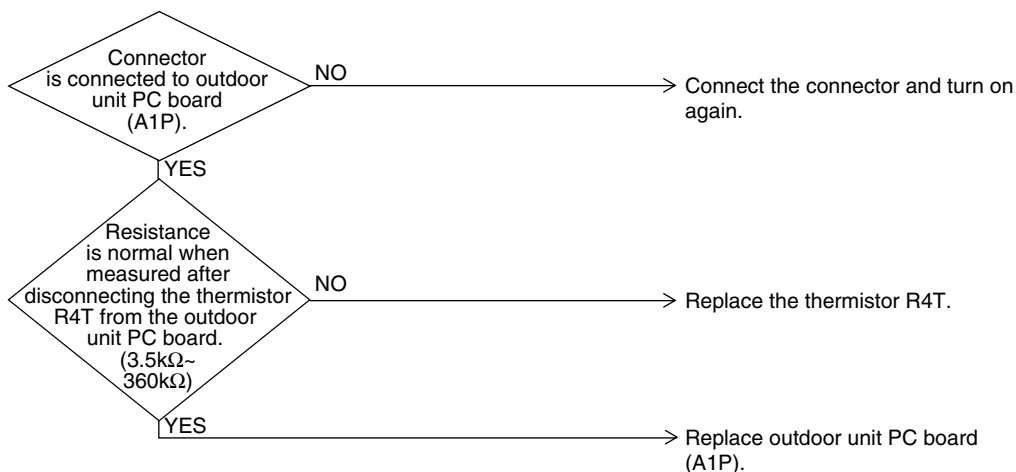

(V3074)



* Refer to “Thermistor Resistance / Temperature Characteristics” table on P179.

4.24 “J9” Outdoor Unit: Malfunction of Subcooling Heat Exchanger Gas Pipe Thermistor (R5T)

Remote Controller Display

J9

Applicable Models

All outdoor unit models

Method of Malfunction Detection

Malfunction is detected according to the temperature detected by subcooling heat exchanger gas pipe thermistor.

Malfunction Decision Conditions

When the subcooling heat exchanger gas pipe thermistor is short circuited or open.

Supposed Causes

- Faulty subcooling heat exchanger gas pipe thermistor (R5T)
- Faulty outdoor unit PC board

Troubleshooting



Caution

Be sure to turn off power switch before connect or disconnect connector, or parts damage may be occurred.

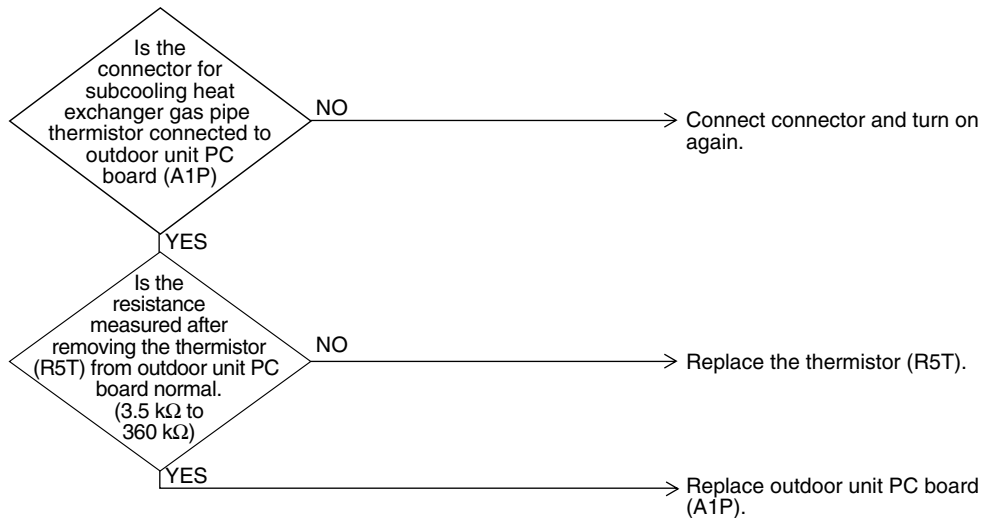

(V3075)



* Refer to “Thermistor Resistance / Temperature Characteristics” table on P179.

4.25 “JA” Outdoor Unit: Malfunction of High Pressure Sensor

Remote
Controller
Display

JA

Applicable
Models

All outdoor unit models

Method of
Malfunction
Detection

Malfunction is detected from the pressure detected by the high pressure sensor.

Malfunction
Decision
Conditions

When the high pressure sensor is short circuit or open circuit.

Supposed
Causes

- Defect of high pressure sensor
- Connection of low pressure sensor with wrong connection.
- Defect of outdoor unit PC board.

Troubleshooting



Caution

Be sure to turn off power switch before connect or disconnect connector, or parts damage may be occurred.

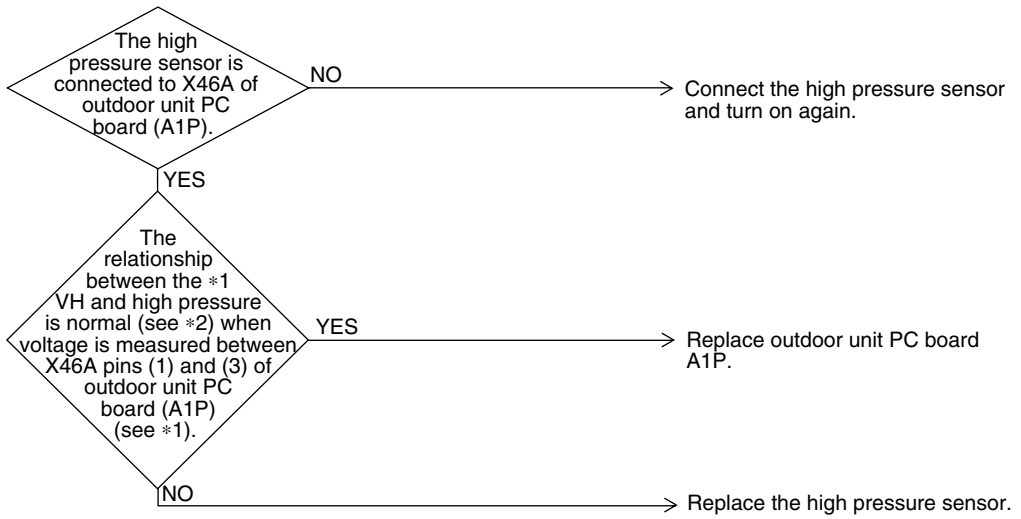

(V2806)

*1: Voltage measurement point

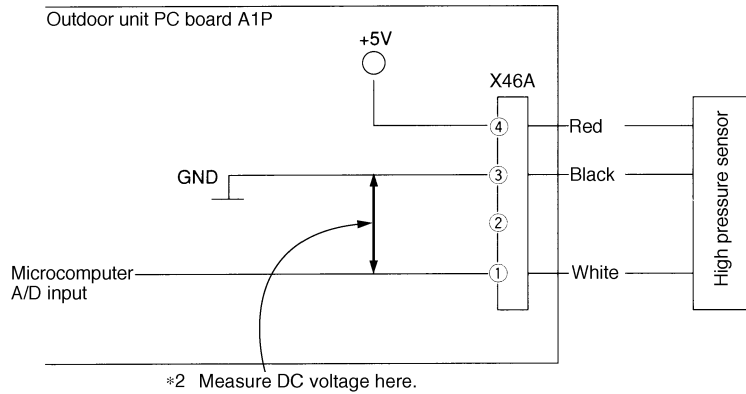

(V2807)



*2: Refer to "Pressure Sensor", pressure / voltage characteristics table on P181.

4.26 “JC” Outdoor Unit: Malfunction of Low Pressure Sensor

Remote Controller Display



Applicable Models

All outdoor unit models

Method of Malfunction Detection

Malfunction is detected from pressure detected by low pressure sensor.

Malfunction Decision Conditions

When the low pressure sensor is short circuit or open circuit.

Supposed Causes

- Defect of low pressure sensor
- Connection of high pressure sensor with wrong connection.
- Defect of outdoor unit PC board.

Troubleshooting



Caution

Be sure to turn off power switch before connect or disconnect connector, or parts damage may be occurred.

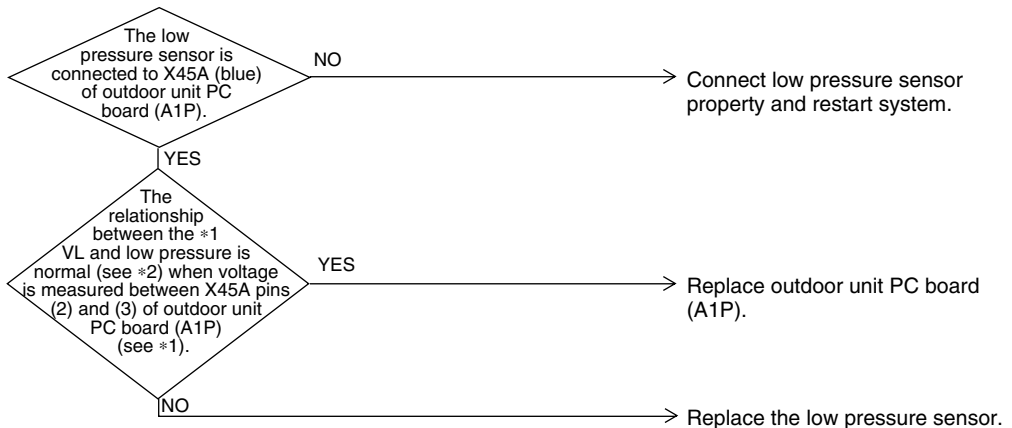

(V2808)

*1: Voltage measurement point

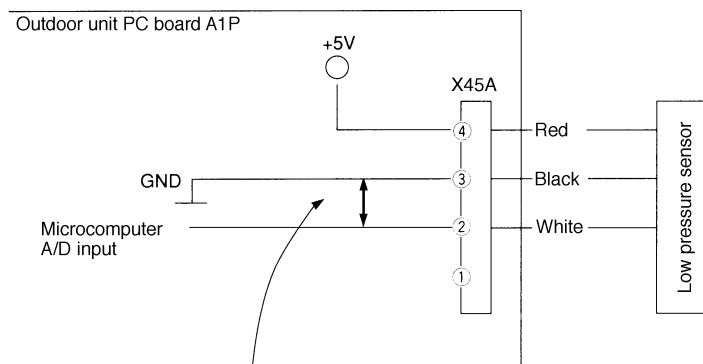

*2 Measure voltage here.

(V2809)



*2: Refer to “Pressure Sensor”, pressure/voltage characteristics table on P181.

4.27 “L4” Outdoor Unit: Malfunction of Inverter Radiating Fin Temperature Rise

Remote Controller Display

L4

Applicable Models

All outdoor unit models

Method of Malfunction Detection

Fin temperature is detected by the thermistor of the radiation fin.

Malfunction Decision Conditions

When the temperature of the inverter radiation fin increases above 210°F.

Supposed Causes

- Actuation of fin thermal (Actuates above 210°F)
- Defect of inverter PC board
- Defect of fin thermistor

Troubleshooting



Caution

Be sure to turn off power switch before connect or disconnect connector, or parts damage may be occurred.

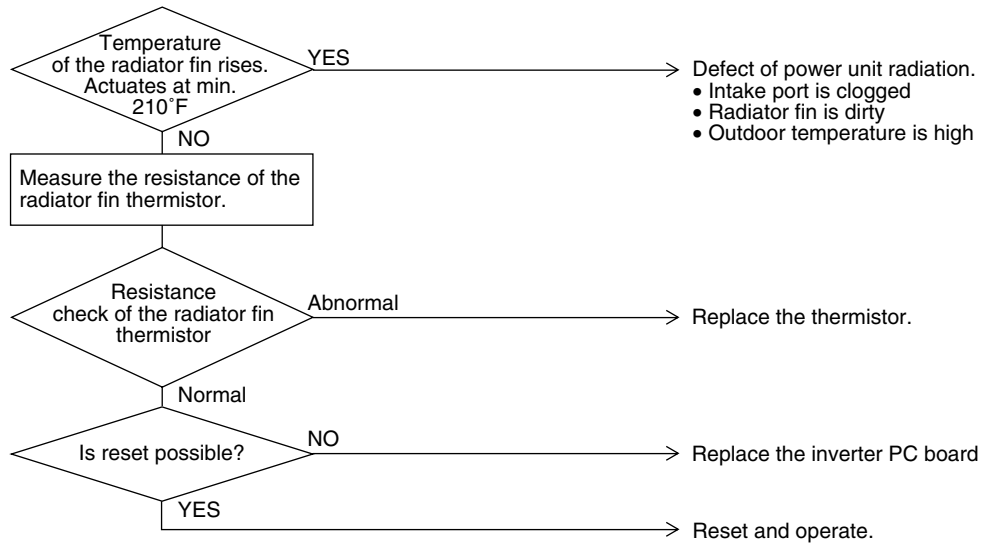

(V3183)



* Refer to “Thermistor Resistance / Temperature Characteristics” table on P179.

4.28 “L5” Outdoor Unit: Inverter Compressor Abnormal

Remote Controller Display

L5

Applicable Models

All outdoor unit models

Method of Malfunction Detection

Malfunction is detected from current flowing in the power transistor.

Malfunction Decision Conditions

When an excessive current flows in the power transistor. (Instantaneous overcurrent also causes activation.)

Supposed Causes

- Defect of compressor coil (disconnected, defective insulation)
- Compressor start-up malfunction (mechanical lock)
- Defect of inverter PC board

Troubleshooting



Caution

Be sure to turn off power switch before connect or disconnect connector, or parts damage may be occurred.

Compressor inspection

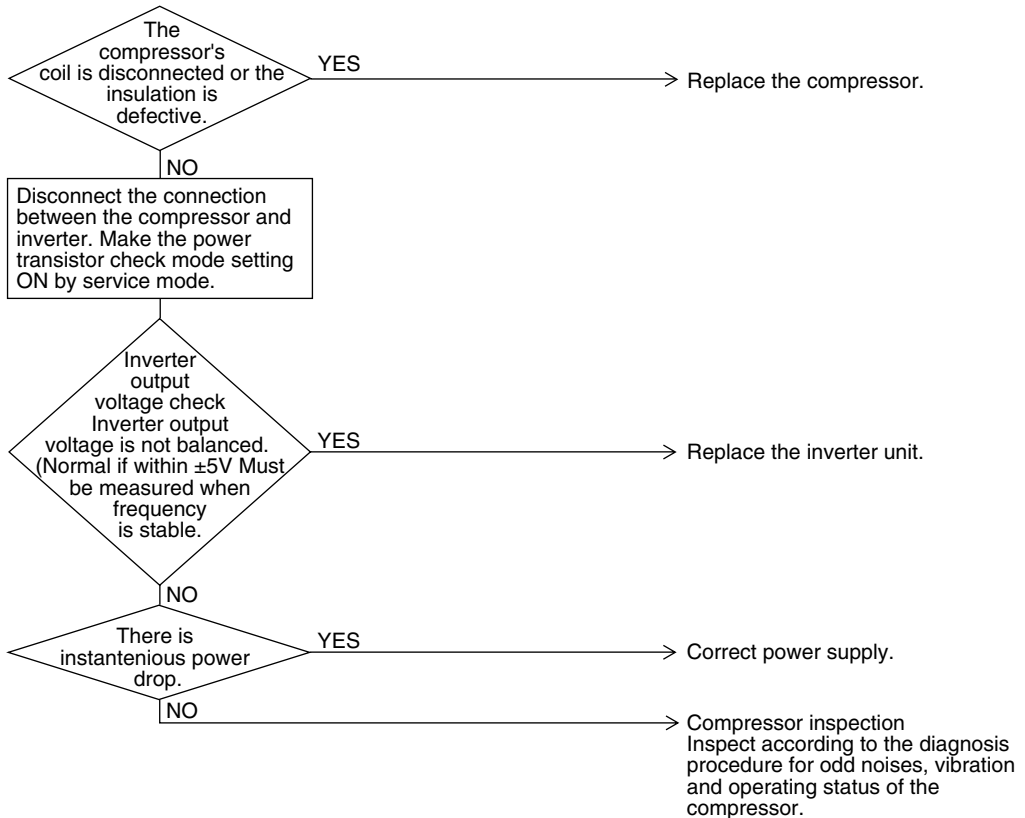

(V2812)

Higher voltage than actual is displayed when the inverter output voltage is checked by tester.

4.29 “L8” Outdoor Unit: Inverter Current Abnormal

Remote
Controller
Display

L8

Applicable
Models

All outdoor unit models

Method of
Malfunction
Detection

Malfunction is detected by current flowing in the power transistor.

Malfunction
Decision
Conditions

When overload in the compressor is detected.

Supposed
Causes

- Compressor overload
- Compressor coil disconnected
- Defect of inverter PC board

Troubleshooting



Caution Be sure to turn off power switch before connect or disconnect connector, or parts damage may be occurred.

Output current check

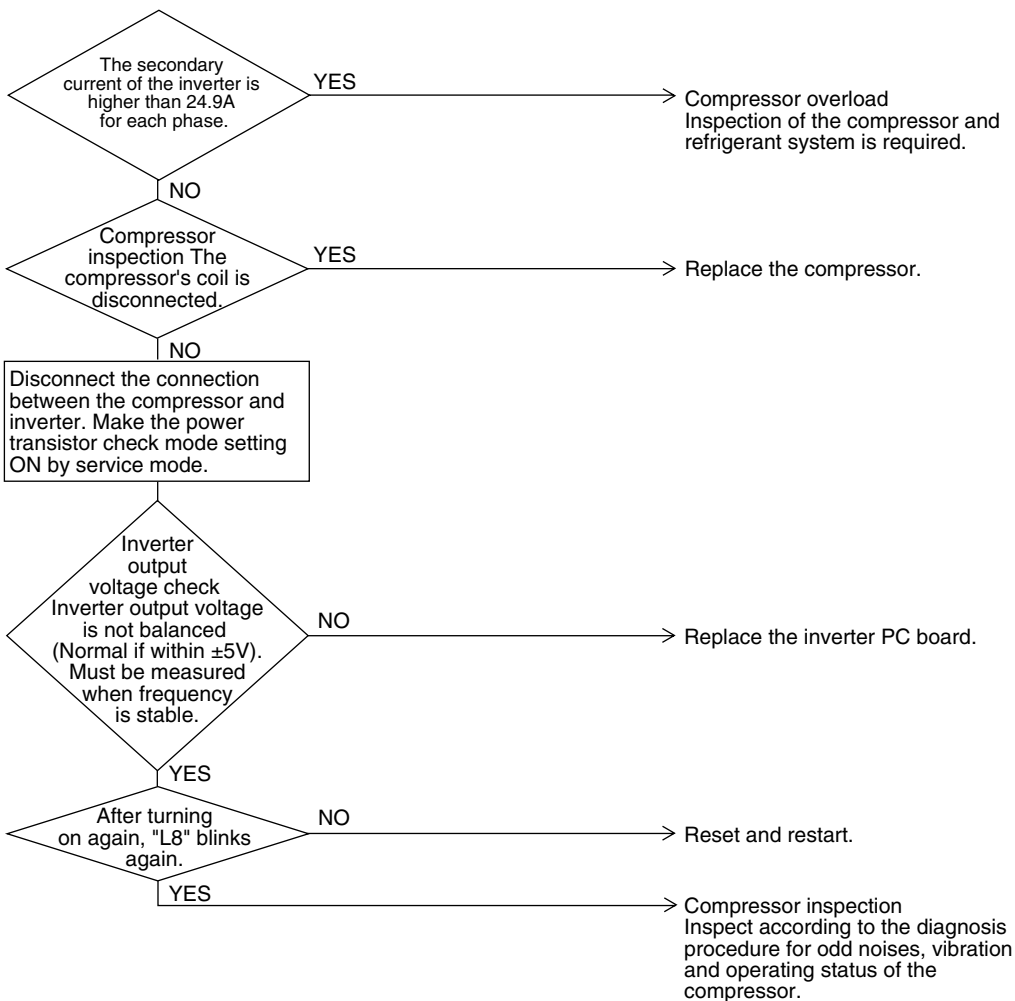

(V3184)

4.30 “L9” Outdoor Unit: Inverter Start up Error

Remote Controller Display

L9

Applicable Models

All outdoor unit models

Method of Malfunction Detection

Malfunction is detected from current flowing in the power transistor.

Malfunction Decision Conditions

When overload in the compressor is detected during startup.

Supposed Causes

- Defect of compressor
- Pressure differential start
- Defect of inverter PC board

Troubleshooting



Caution

Be sure to turn off power switch before connect or disconnect connector, or parts damage may be occurred.

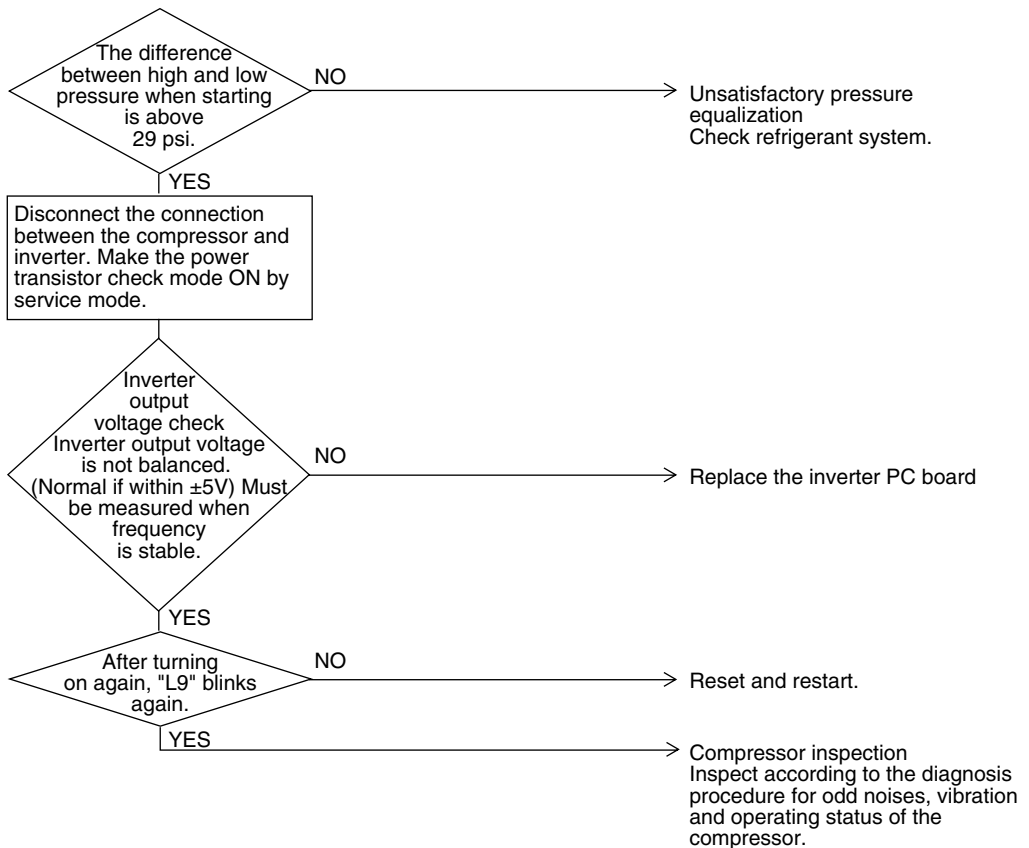

(V2814)

4.31 “LC” Outdoor Unit: Malfunction of Transmission between Inverter and Control PC Board

Remote
Controller
Display

LC

Applicable
Models

All outdoor unit models

Method of
Malfunction
Detection

Check the communication state between inverter PC board and control PC board by micro-computer.

Malfunction
Decision
Conditions

When the correct communication is not conducted in certain period.

Supposed
Causes

- Malfunction of connection between the inverter PC board and outdoor control PC board
- Defect of outdoor control PC board (transmission section)
- Defect of inverter PC board
- Defect of noise filter
- External factor (Noise etc.)

Troubleshooting



Caution

Be sure to turn off power switch before connect or disconnect connector, or parts damage may be occurred.

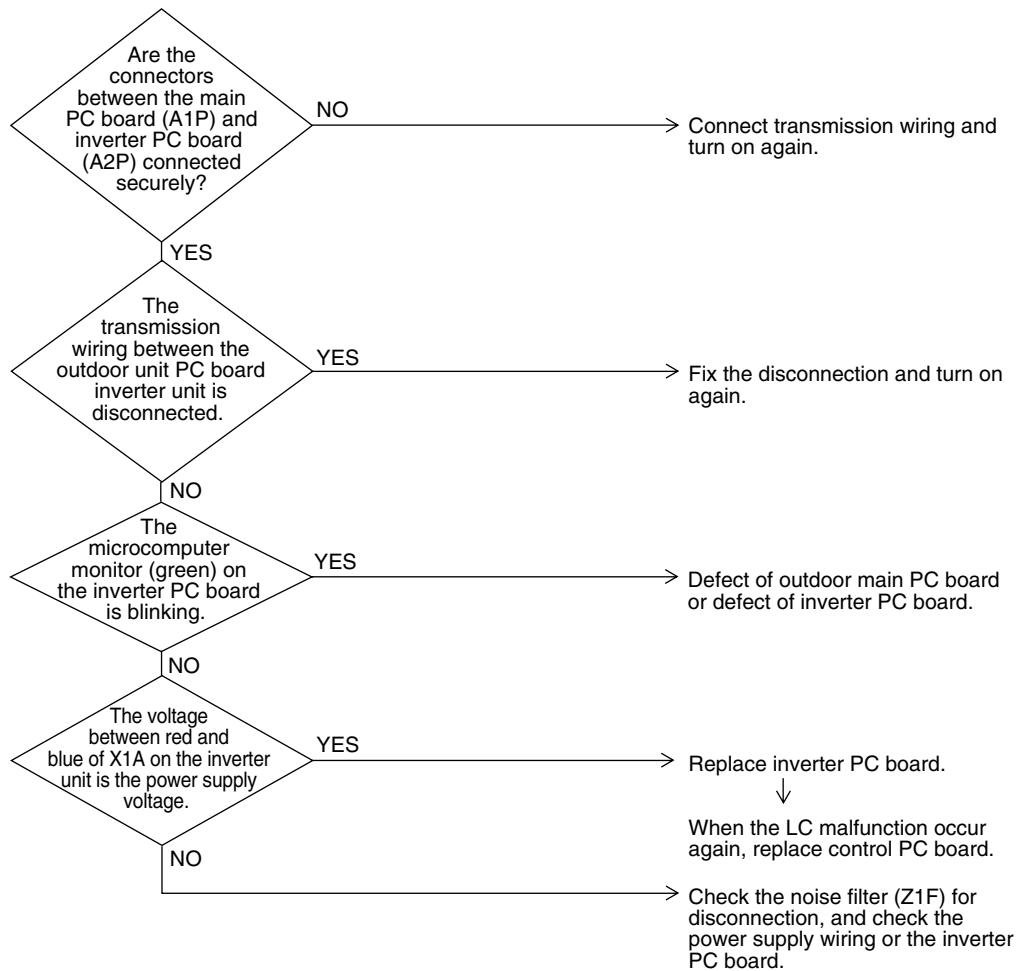

(V3185)

4.32 “P4” Outdoor Unit: Malfunction of Inverter Radiating Fin Temperature Rise Sensor

Remote Controller Display	P4
Applicable Models	All outdoor unit models
Method of Malfunction Detection	Resistance of radiation fin thermistor is detected when the compressor is not operating.
Malfunction Decision Conditions	When the resistance value of thermistor becomes a value equivalent to open or short circuited status. ★Malfunction is not decided while the unit operation is continued. "P4" will be displayed by pressing the inspection button.
Supposed Causes	<ul style="list-style-type: none"> ■ Defect of radiator fin temperature sensor ■ Defect of inverter PC board

Troubleshooting

 **Caution** Be sure to turn off power switch before connect or disconnect connector, or parts damage may be occurred.

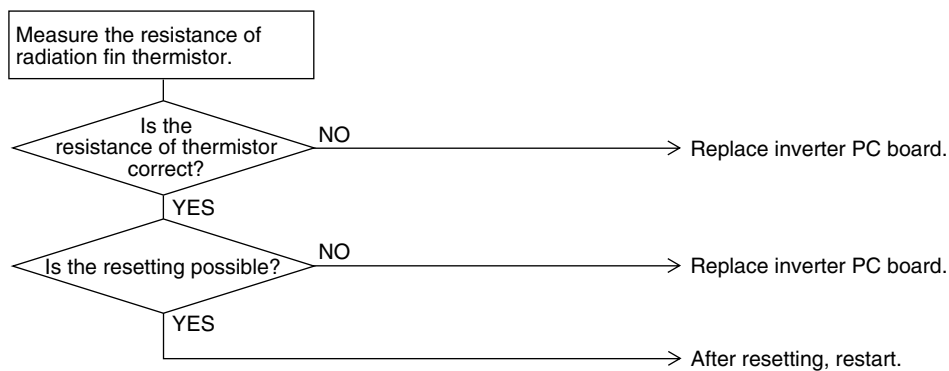

(V2818)



* Refer to “Thermistor Resistance / Temperature Characteristics” table on P179.

4.33 “PJ” Outdoor Unit: Faulty Combination of Inverter and Fan Driver

Remote Controller Display

PJ

Applicable Models

All outdoor unit models

Method of Malfunction Detection

Check the communication state between inverter PC board and control PC board by micro-computer.

Malfunction Decision Conditions

When the communication data about inverter PC board type is incorrect.

Supposed Causes

- Mismatching of inverter PC board
- Faulty field setting

Troubleshooting



Caution

Be sure to turn off power switch before connect or disconnect connector, or parts damage may be occurred.

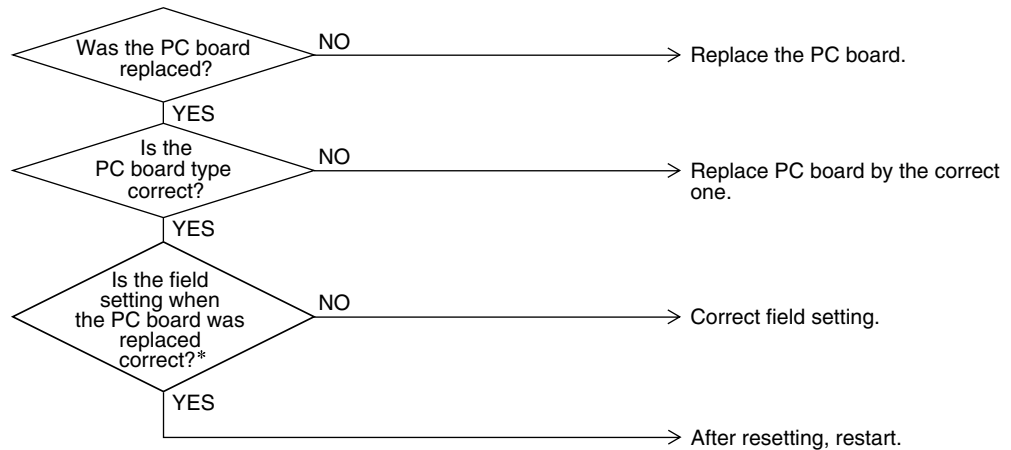

(V3151)



* Refer to “Field Setting from Outdoor Unit” on P62.

4.34 “UO” Outdoor Unit: Low Pressure Drop Due to Refrigerant Shortage or Electronic Expansion Valve Failure

Remote Controller Display

UO

Applicable Models

All outdoor unit models

Method of Malfunction Detection

Short of gas malfunction is detected by discharge pipe temperature thermistor.

Malfunction Decision Conditions

Microcomputer judge and detect if the system is short of refrigerant.
 ★Malfunction is not decided while the unit operation is continued.

Supposed Causes

- Out of gas or refrigerant system clogging (incorrect piping)
- Defect of thermistor R2T or R4T
- Defect of pressure sensor
- Defect of outdoor unit PC board (A1P)

Troubleshooting



Caution

Be sure to turn off power switch before connect or disconnect connector, or parts damage may be occurred.

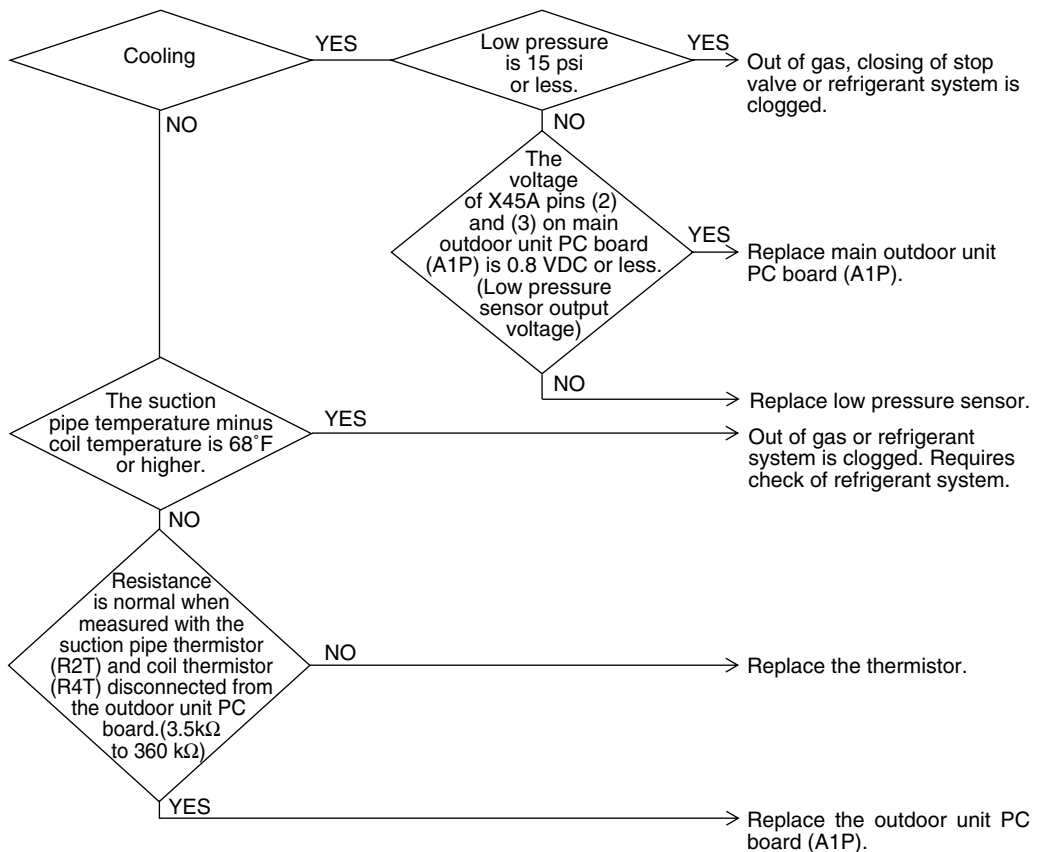

(V2819)

4.35 “U2” Outdoor Unit: Power Supply Insufficient or Instantaneous Failure

Remote Controller Display	U2
Applicable Models	All outdoor unit models
Method of Malfunction Detection	Detection of voltage of main circuit capacitor built in the inverter and power supply voltage.
Malfunction Decision Conditions	When the capacitor above only has a voltage of 190 V or less.
Supposed Causes	<ul style="list-style-type: none"> ■ Power supply insufficient ■ Instantaneous failure ■ Defect of inverter PC board ■ Defect of outdoor control PC board ■ Main circuit wiring defect

Troubleshooting



Caution

Be sure to turn off power switch before connect or disconnect connector, or parts damage may be occurred.

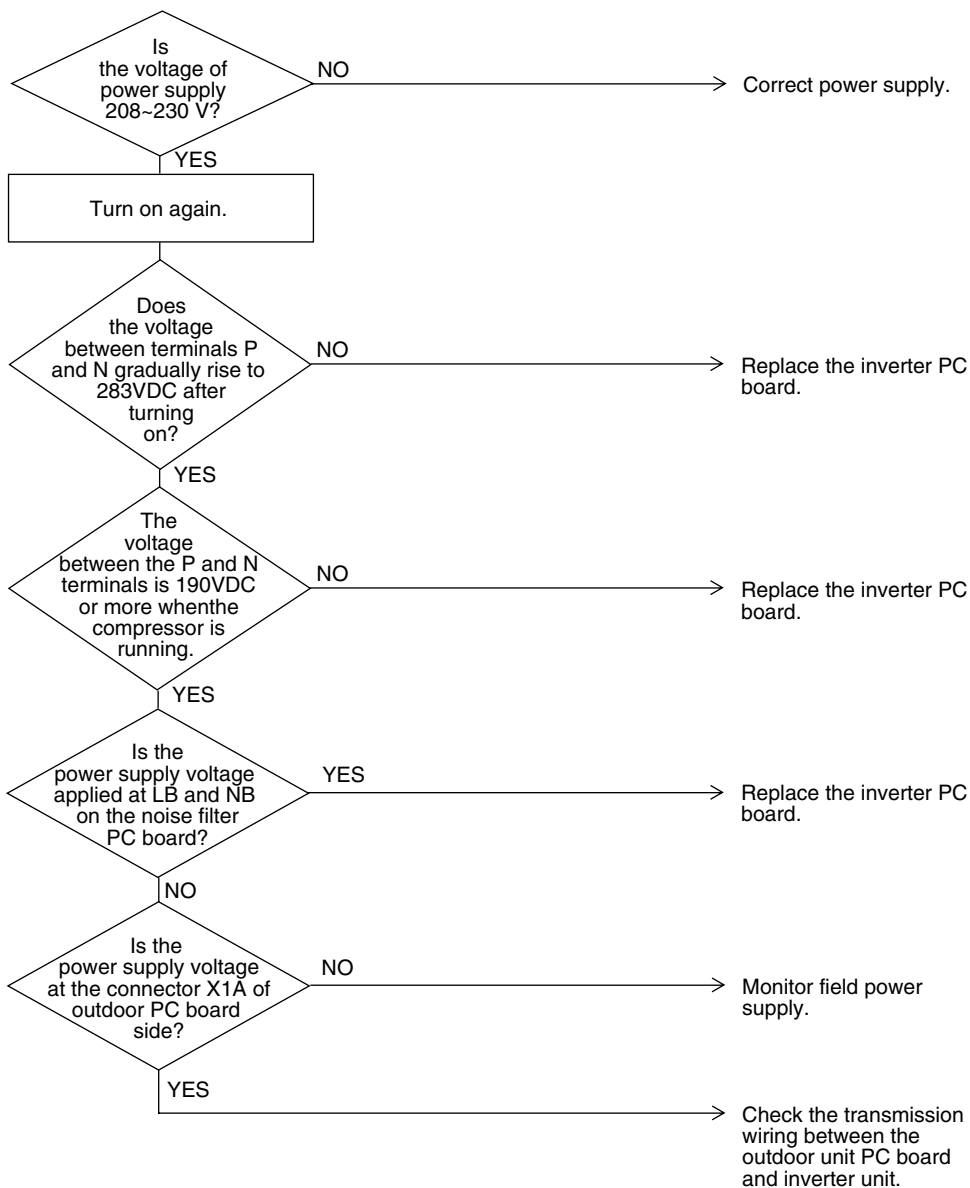

(V3186)

4.36 “U3” Outdoor Unit: Check Operation not Executed

Remote
Controller
Display

U3

Applicable
Models

All outdoor unit models

Method of
Malfunction
Detection

Check operation is executed or not

Malfunction
Decision
Conditions

Malfunction is decided when the unit starts operation without check operation.

Supposed
Causes

- Check operation is not executed.

Troubleshooting



Caution

Be sure to turn off power switch before connect or disconnect connector, or parts damage may be occurred.

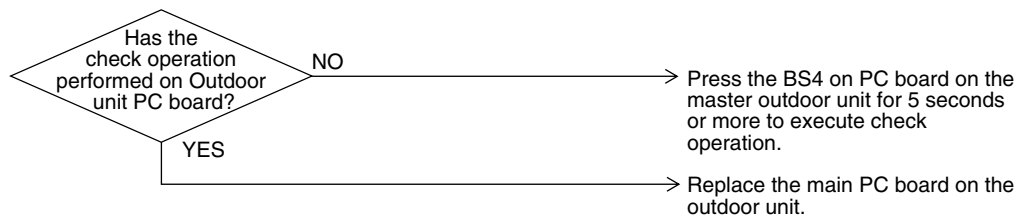

(V3052)

4.37 “U4” Malfunction of Transmission between Indoor Units and Outdoor Units

Remote Controller Display	U4
Applicable Models	All indoor unit models All outdoor unit models
Method of Malfunction Detection	Microcomputer checks if transmission between indoor and outdoor units is normal.
Malfunction Decision Conditions	When transmission is not carried out normally for a certain amount of time
Supposed Causes	<ul style="list-style-type: none"> ■ Indoor to outdoor, outdoor to outdoor transmission wiring F1, F2 disconnection, short circuit or wrong wiring ■ Outdoor unit power supply is OFF ■ System address doesn't match ■ Defect of outdoor unit PC board ■ Defect of indoor unit PC board

Troubleshooting



Caution Be sure to turn off power switch before connect or disconnect connector, or parts damage may be occurred.

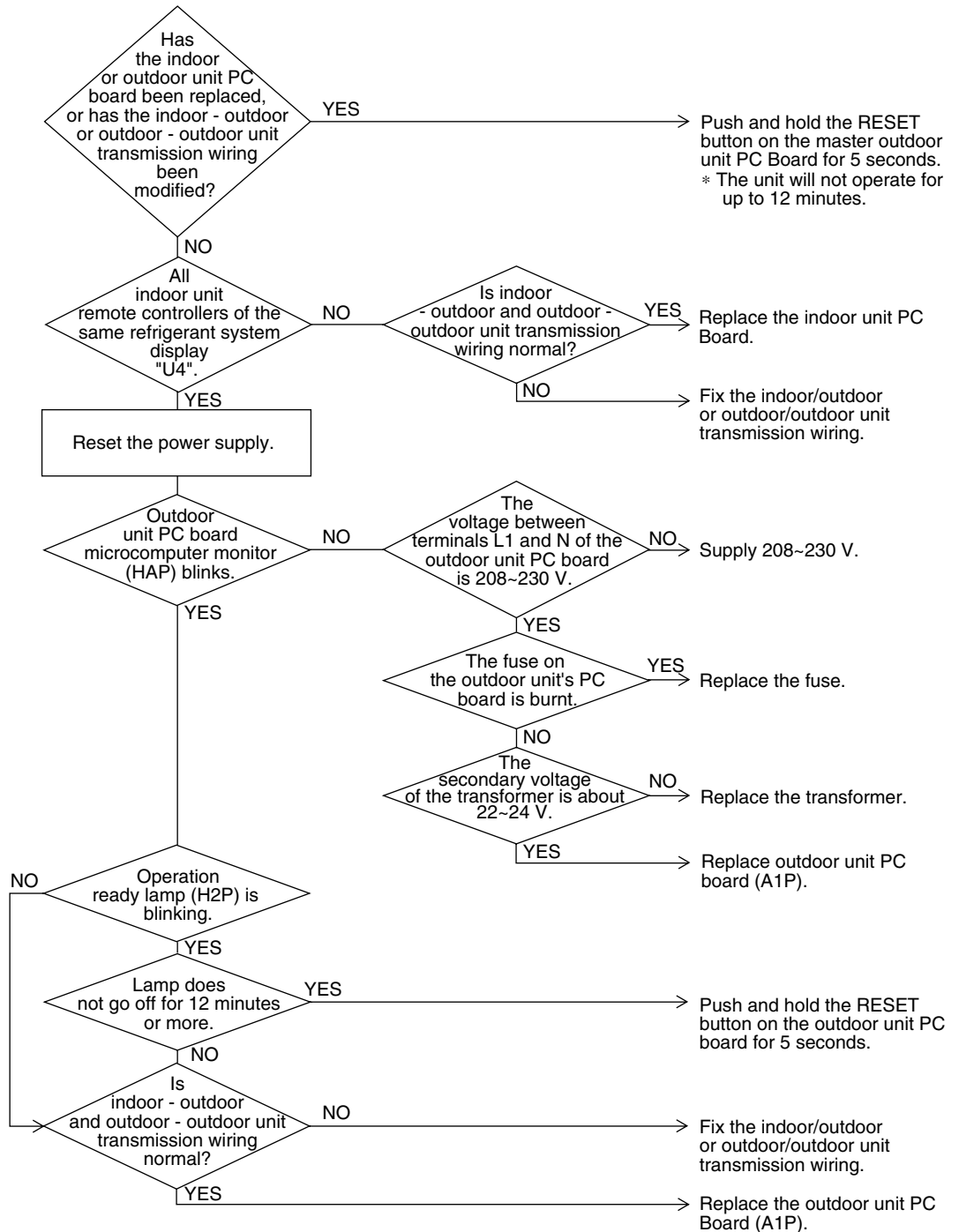

(V3187)

4.38 “U5” Indoor Unit: Malfunction of Transmission between Remote Controller and Indoor Unit

Remote Controller Display

U5

Applicable Models

All indoor unit models

Method of Malfunction Detection

In case of controlling with 2-remote controller, check the system using microcomputer is signal transmission between indoor unit and remote controller (main and sub) is normal.

Malfunction Decision Conditions

Normal transmission does not continue for specified period.

Supposed Causes

- Malfunction of indoor unit remote controller transmission
- Connection of two main remote controllers (when using 2 remote controllers)
- Defect of indoor unit PC board
- Defect of remote controller PC board
- Malfunction of transmission caused by noise

Troubleshooting



Caution

Be sure to turn off power switch before connect or disconnect connector, or parts damage may be occurred.

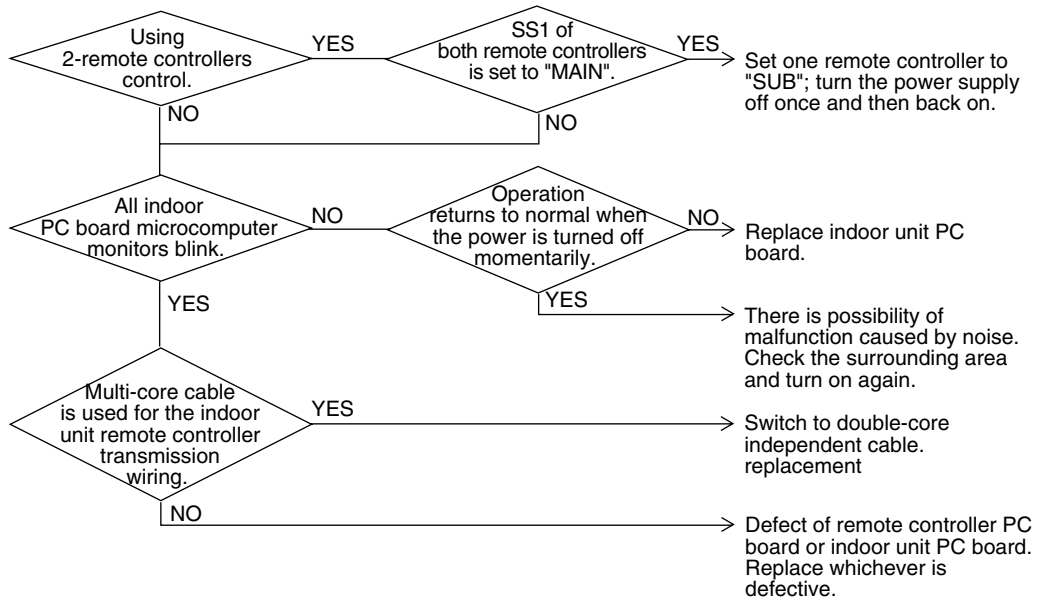

(V2823)

4.39 “UB” Indoor Unit: Malfunction of Transmission between Main and Sub Remote Controllers

Remote Controller Display

UB

Applicable Models

All indoor unit models

Method of Malfunction Detection

In case of controlling with 2-remote controller, check the system using microcomputer if signal transmission between indoor unit and remote controller (main and sub) is normal.

Malfunction Decision Conditions

Normal transmission does not continue for specified period.

Supposed Causes

- Malfunction of transmission between main and sub remote controller
- Connection between sub remote controllers
- Defect of remote controller PC board

Troubleshooting



Caution

Be sure to turn off power switch before connect or disconnect connector, or parts damage may be occurred.

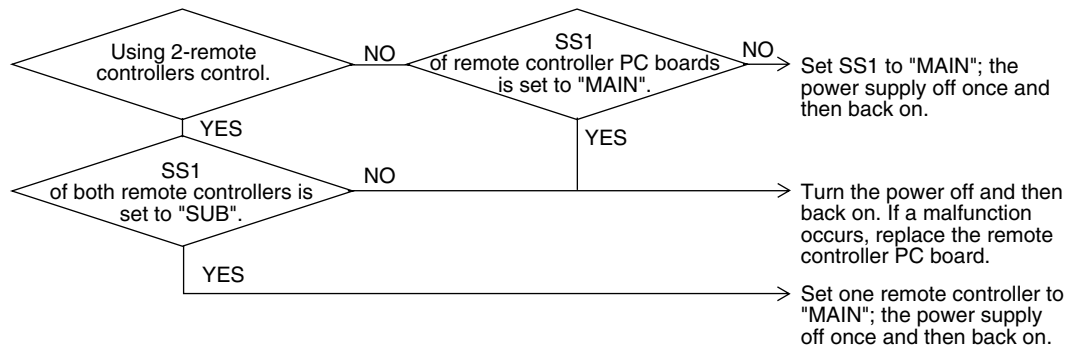

(V2825)

4.40 “U9” Indoor Unit: Malfunction of Transmission between Indoor Units and Outdoor Units in the Same System

Remote Controller Display	U9
Applicable Models	All indoor unit models
Method of Malfunction Detection	Detect the malfunction signal of any other indoor unit within the system concerned.
Malfunction Decision Conditions	When the malfunction decision is made on any other indoor unit within the system concerned.
Supposed Causes	<ul style="list-style-type: none"> ■ Malfunction of transmission within or outside of other system ■ Malfunction of electronic expansion valve in indoor unit of other system ■ Defect of PC board of indoor unit in other system ■ Improper connection of transmission wiring between indoor and outdoor unit

Troubleshooting



Caution

Be sure to turn off power switch before connect or disconnect connector, or parts damage may be occurred.

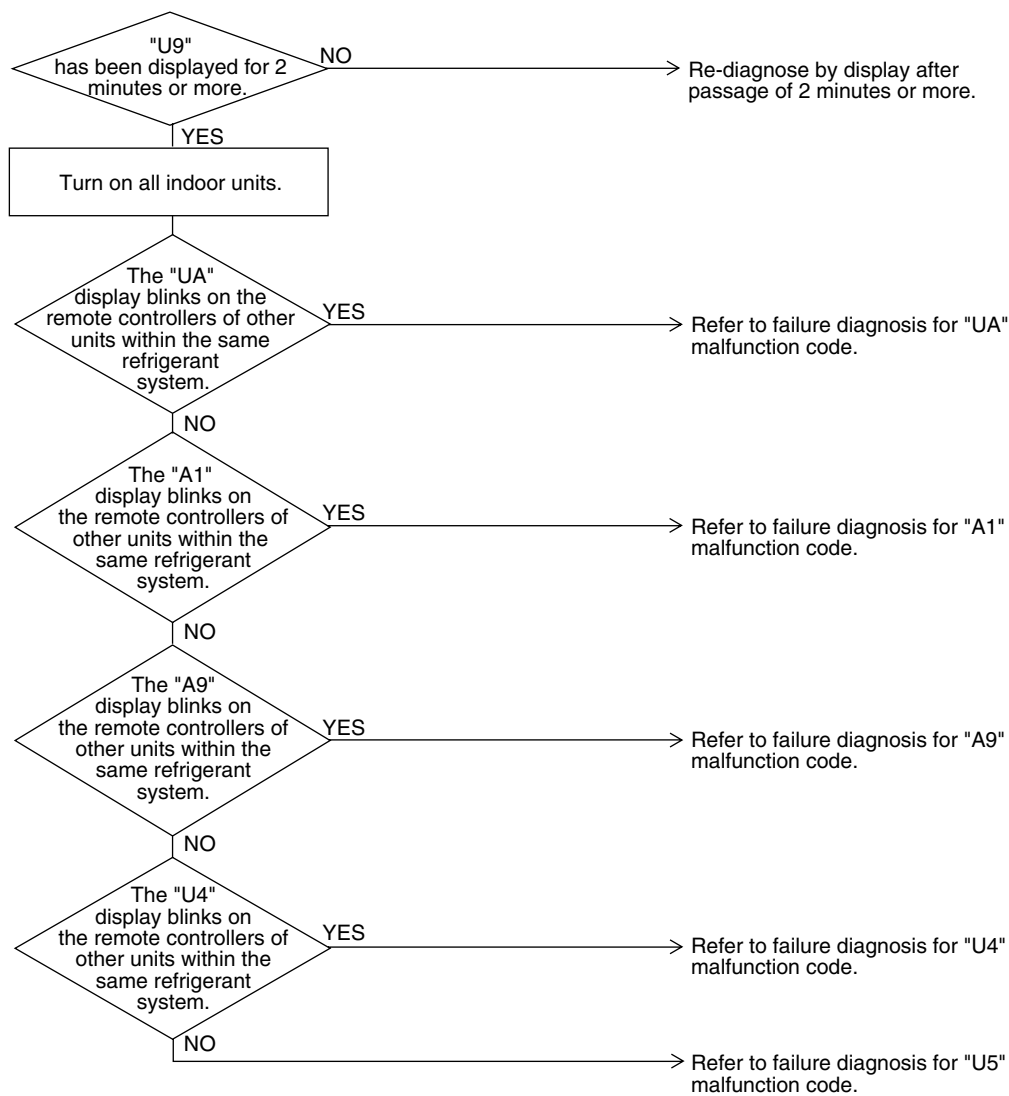

(V2826)

4.41 “UR” Improper Combination of Indoor Units and Outdoor Units, Indoor Units and Remote Controller

Remote Controller Display

UR

Applicable Models

All indoor unit models
All outdoor unit models
Remote controller

Method of Malfunction Detection

A difference occurs in data by the type of refrigerant between indoor and outdoor units.
The number of indoor units is outside of the allowable range.

Malfunction Decision Conditions

The malfunction decision is made as soon as either of the abnormalities aforementioned is detected.

Supposed Causes

- Excess of connected indoor units
- Defect of outdoor unit PC board (A1P)
- Mismatching of the refrigerant type of indoor and outdoor unit.
- Setting of outdoor PC board was not conducted after replacing to spare parts PC board.

Troubleshooting



Caution

Be sure to turn off power switch before connect or disconnect connector, or parts damage may be occurred.

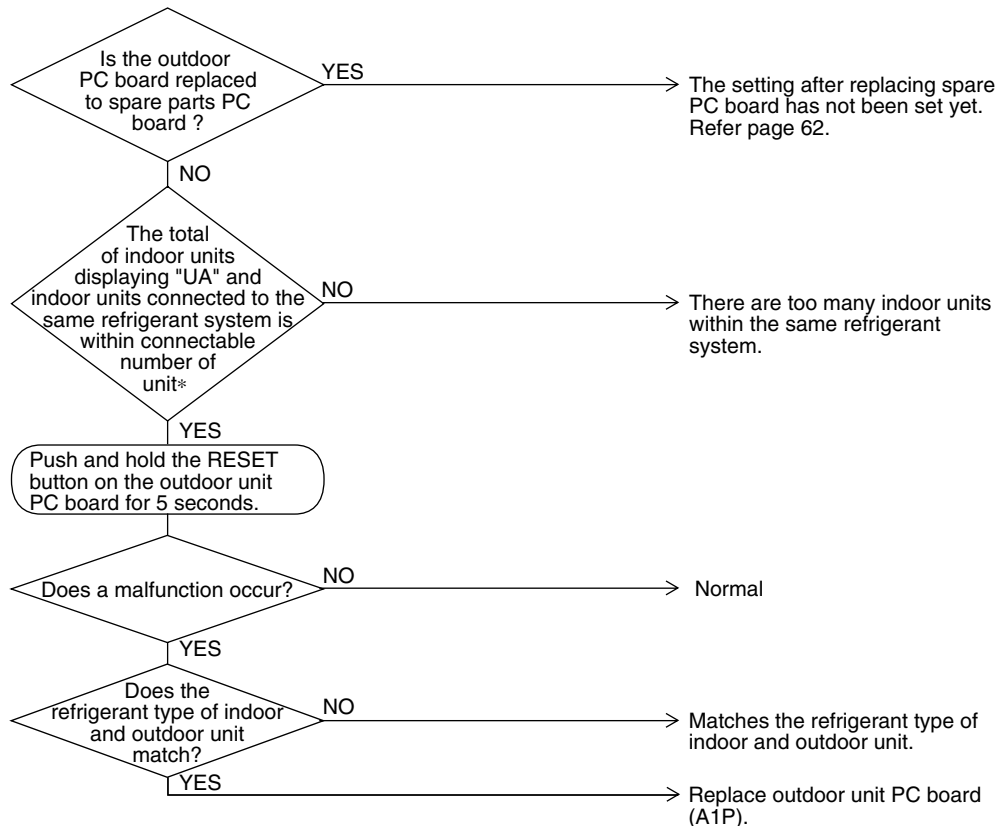

(V3169)

* The number of indoor units that can be connected to a single outdoor unit system depends on the type of outdoor unit.

4.42 “UC” Address Duplication of Centralized Controller

Remote
Controller
Display

UC

Applicable
Models

All indoor unit models
Centralized controller

Method of
Malfunction
Detection

The principal indoor unit detects the same address as that of its own on any other indoor unit.

Malfunction
Decision
Conditions

The malfunction decision is made as soon as the abnormality aforementioned is detected.

Supposed
Causes

- Address duplication of centralized controller
- Defect of indoor unit PC board

Troubleshooting



Caution

Be sure to turn off power switch before connect or disconnect connector, or parts damage may be occurred.

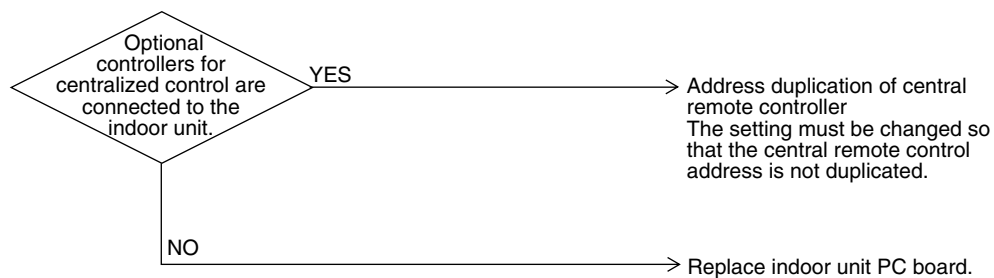

(V2828)

4.43 “UE” Malfunction of Transmission between Centralized Controller and Indoor Unit

Remote Controller Display	UE
Applicable Models	All indoor unit models Centralized controller
Method of Malfunction Detection	Microcomputer checks if transmission between indoor unit and centralized controller is normal.
Malfunction Decision Conditions	When transmission is not carried out normally for a certain amount of time
Supposed Causes	<ul style="list-style-type: none"> ■ Malfunction of transmission between optional controllers for centralized control and indoor unit ■ Connector for setting master controller is disconnected. ■ Failure of PC board for central remote controller ■ Defect of indoor unit PC board

Troubleshooting



Caution

Be sure to turn off power switch before connect or disconnect connector, or parts damage may be occurred.

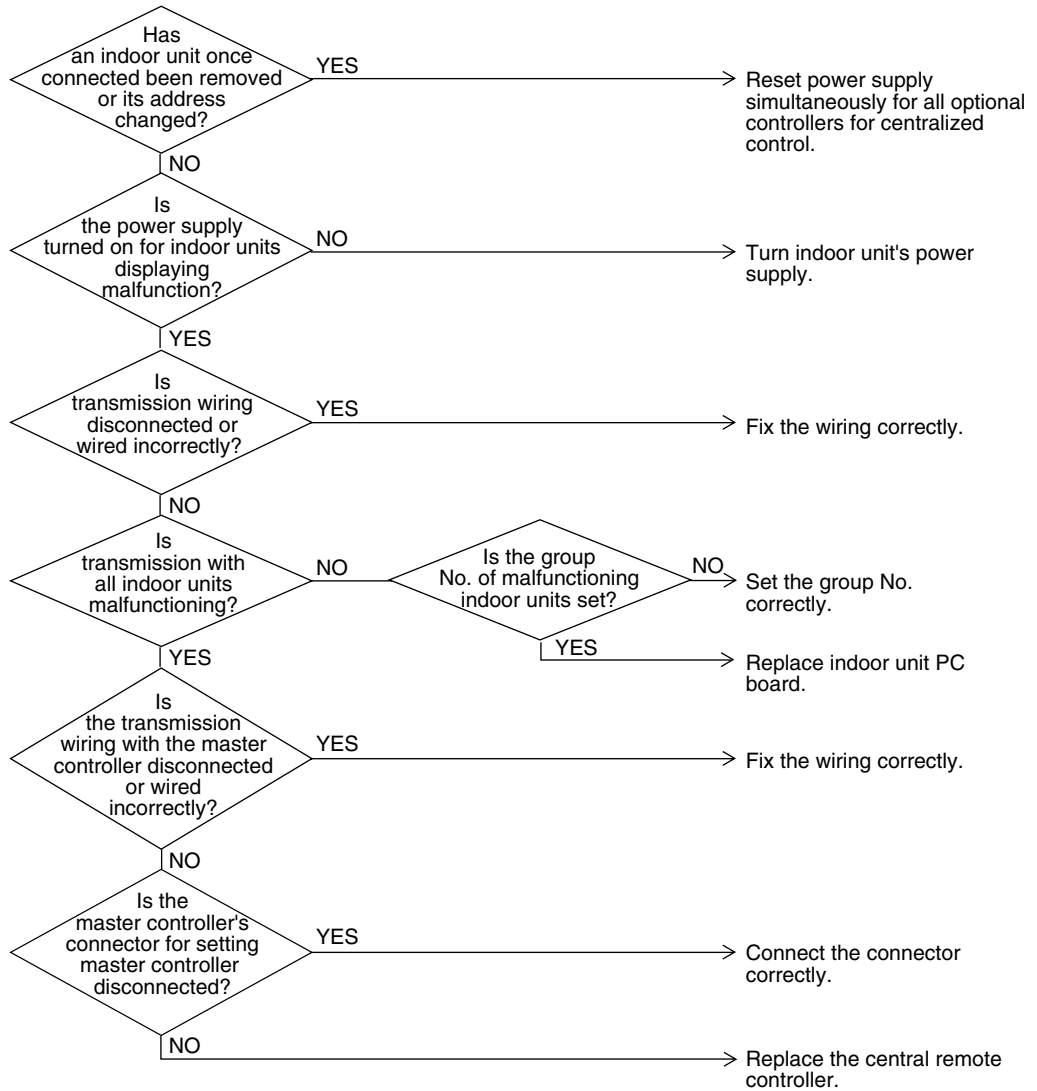

(V2829)

4.44 “UF” System is not Set yet

Remote Controller Display

UF

Applicable Models

All indoor unit models
All outdoor unit models

Method of Malfunction Detection

The number of indoor units in terms of data transmission becomes mismatched to that of indoor units with changes in temperature on operation for checks.

Malfunction Decision Conditions

The malfunction is determined as soon as the abnormality aforementioned is detected through checking the system for any erroneous connection of units on the check operation.

Supposed Causes

- Improper connection of transmission wiring between indoor-outdoor units and outdoor-outdoor units.
- Failure to execute check operation
- Defect of indoor unit PC board
- Stop valve is left in closed.

Troubleshooting



Caution

Be sure to turn off power switch before connect or disconnect connector, or parts damage may be occurred.

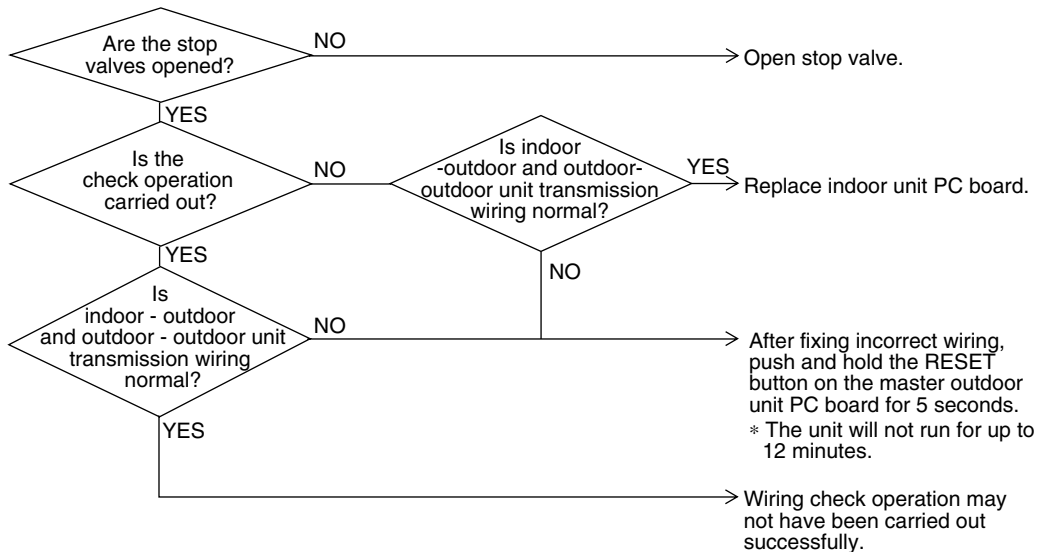

(V2830)



Note:

Wiring check operation may not be successful if carried out after the outdoor unit has been off for more than 12 hours, or if it is not carried out after running all connected indoor units in the fan mode for at least an hour.

4.45 “UH” Malfunction of System, Refrigerant System Address Undefined

Remote Controller Display

UH

Applicable Models

All indoor unit models
All outdoor unit models

Method of Malfunction Detection

Detect an indoor unit with no address setting.

Malfunction Decision Conditions

The malfunction decision is made as soon as the abnormality aforementioned is detected.

Supposed Causes

- Improper connection of transmission wiring between indoor-outdoor units and outdoor-outdoor units.
- Defect of indoor unit PC board
- Defect of outdoor unit PC board (A1P)

Troubleshooting



Caution

Be sure to turn off power switch before connect or disconnect connector, or parts damage may be occurred.

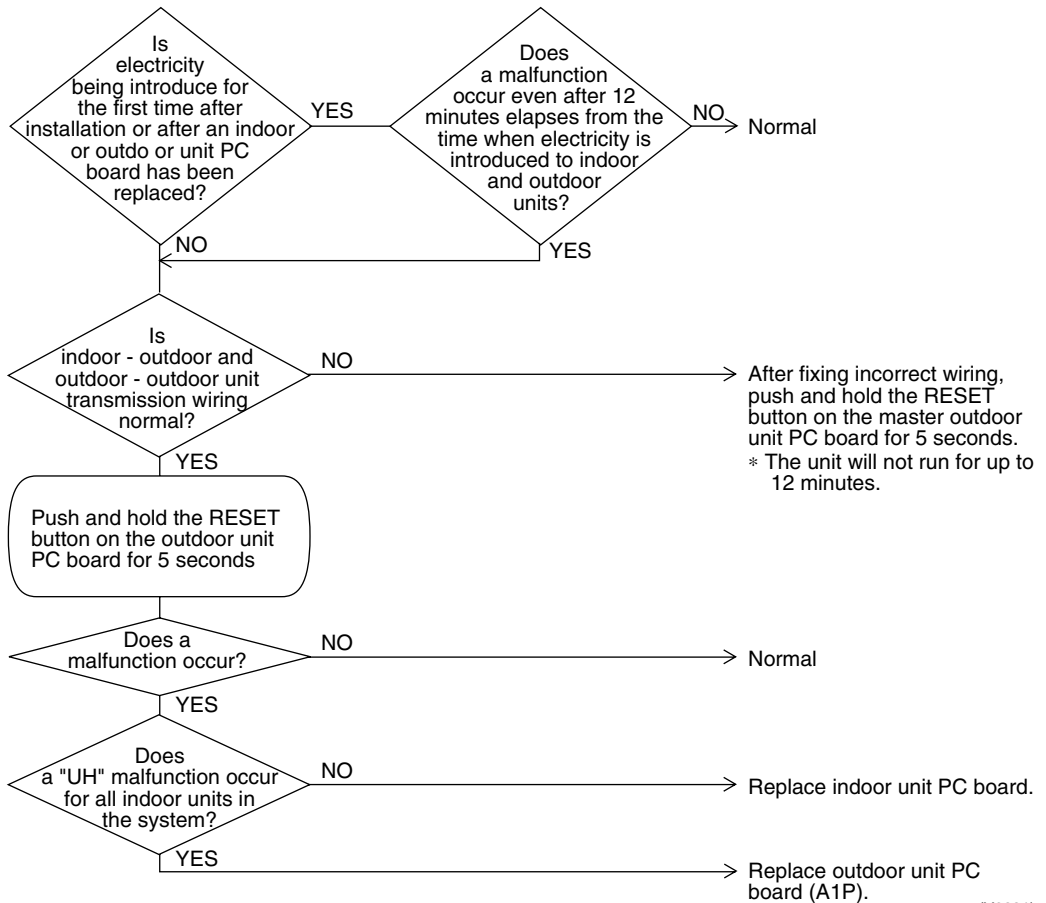

(V2831)

5. Troubleshooting by Indication on the Central Remote Controller

5.1 “M” PC Board Defect

Remote Controller Display	M
Applicable Models	Central remote controller
Method of Malfunction Detection	Detect an abnormality in the DIII-NET polarity circuit.
Malfunction Decision Conditions	When + polarity and - polarity are detected at the same time.
Supposed Causes	<ul style="list-style-type: none"> ■ Defect of central remote controller PC board
Troubleshooting	Replace the central remote controller.

5.2 “M8” Malfunction of Transmission between Optional Controllers for Centralized Control

Remote Controller Display

M8

Applicable Models

Central remote controller

Method of Malfunction Detection

Detect the malfunction according to DIII-NET transmission data. (The system will be automatically reset.)

Malfunction Decision Conditions

When no master controller is present at the time of the startup of slave controller.
When optional controllers for the centralized control which was connected once, shows no response.

Supposed Causes

- Malfunction of transmission between optional controllers for centralized control
- Defect of PC board of optional controllers for centralized control

Troubleshooting



Caution

Be sure to turn off power switch before connect or disconnect connector, or parts damage may be occurred.

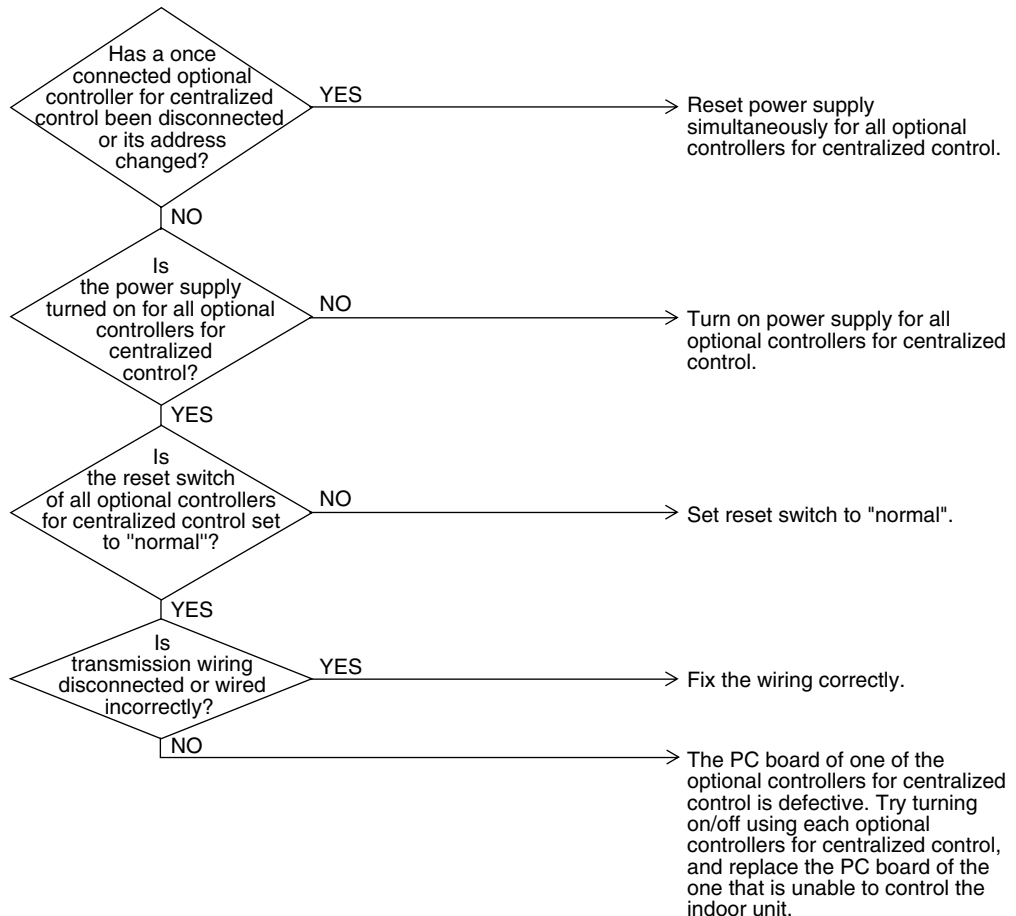

(V2833)

5.3 “*MR*” Improper Combination of Optional Controllers for Centralized Control

Remote Controller Display	<i>MR</i>
Applicable Models	Central remote controller
Method of Malfunction Detection	Detect the malfunction according to DIII-NET transmission data.
Malfunction Decision Conditions	When the schedule timer is set to individual use mode, other central component is present. When multiple master controller are present. When the remote control adapter is present.
Supposed Causes	<ul style="list-style-type: none"> ■ Improper combination of optional controllers for centralized control ■ More than one master controller is connected ■ Defect of PC board of optional controller for centralized control

Troubleshooting



Caution

Be sure to turn off power switch before connect or disconnect connector, or parts damage may be occurred.

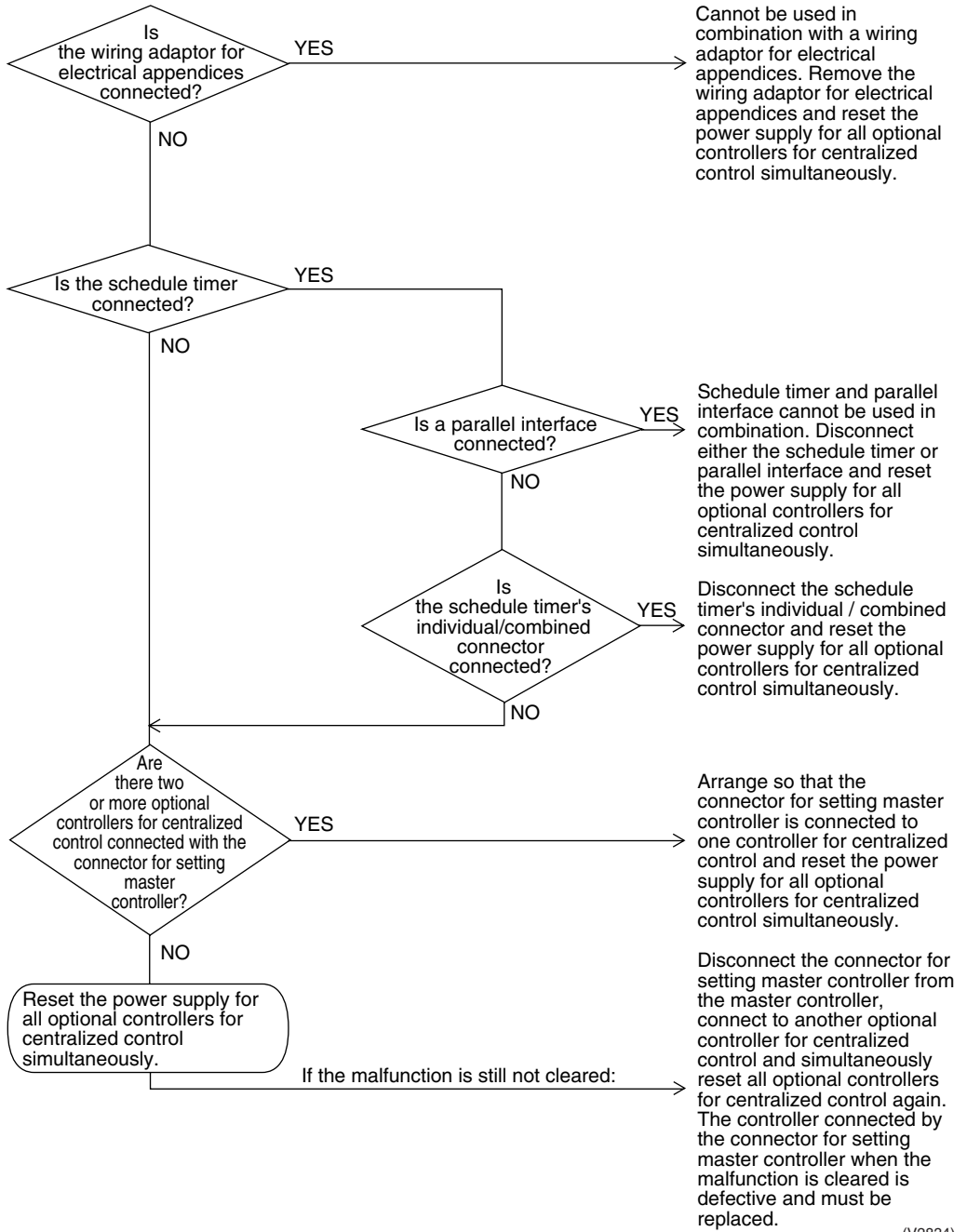

(V2834)

5.4 “MC” Address Duplication, Improper Setting

Remote Controller Display

MC

Applicable Models

Central remote controller

Method of Malfunction Detection

Detect the malfunction according to DIII-NET transmission data.

Malfunction Decision Conditions

Two units are both set to master controller mode or slave controller mode.

Supposed Causes

- Address duplication of central remote controller

Troubleshooting



Caution

Be sure to turn off power switch before connect or disconnect connector, or parts damage may be occurred.

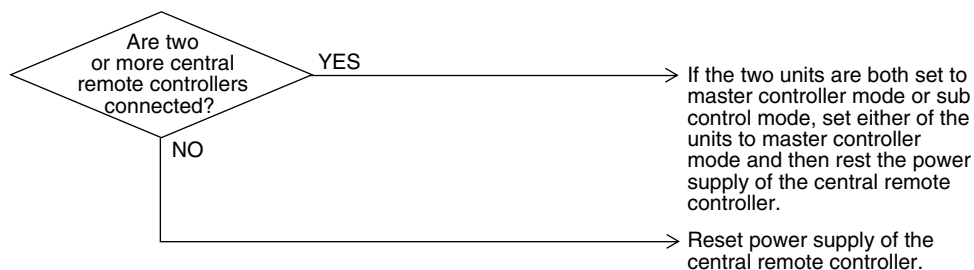

(V2835)

6. Troubleshooting by Indication on the Unified ON/OFF Controller

6.1 Operation Lamp Blinks

**Remote
Controller
Display**

Operation lamp blinks

**Applicable
Models**

All models of indoor units
Unified ON/OFF controller

**Method of
Malfunction
Detection**

Detect the malfunction according to DIII-NET transmission data.

**Malfunction
Decision
Conditions****Supposed
Causes**

- Malfunction of transmission between central remote controller and indoor unit
- Connector for setting master controller is disconnected
- Defect of unified ON/OFF controller PC board
- Defect of indoor unit PC board
- Malfunction of air conditioner

Troubleshooting

 **Caution** Be sure to turn off power switch before connect or disconnect connector, or parts damage may be occurred.

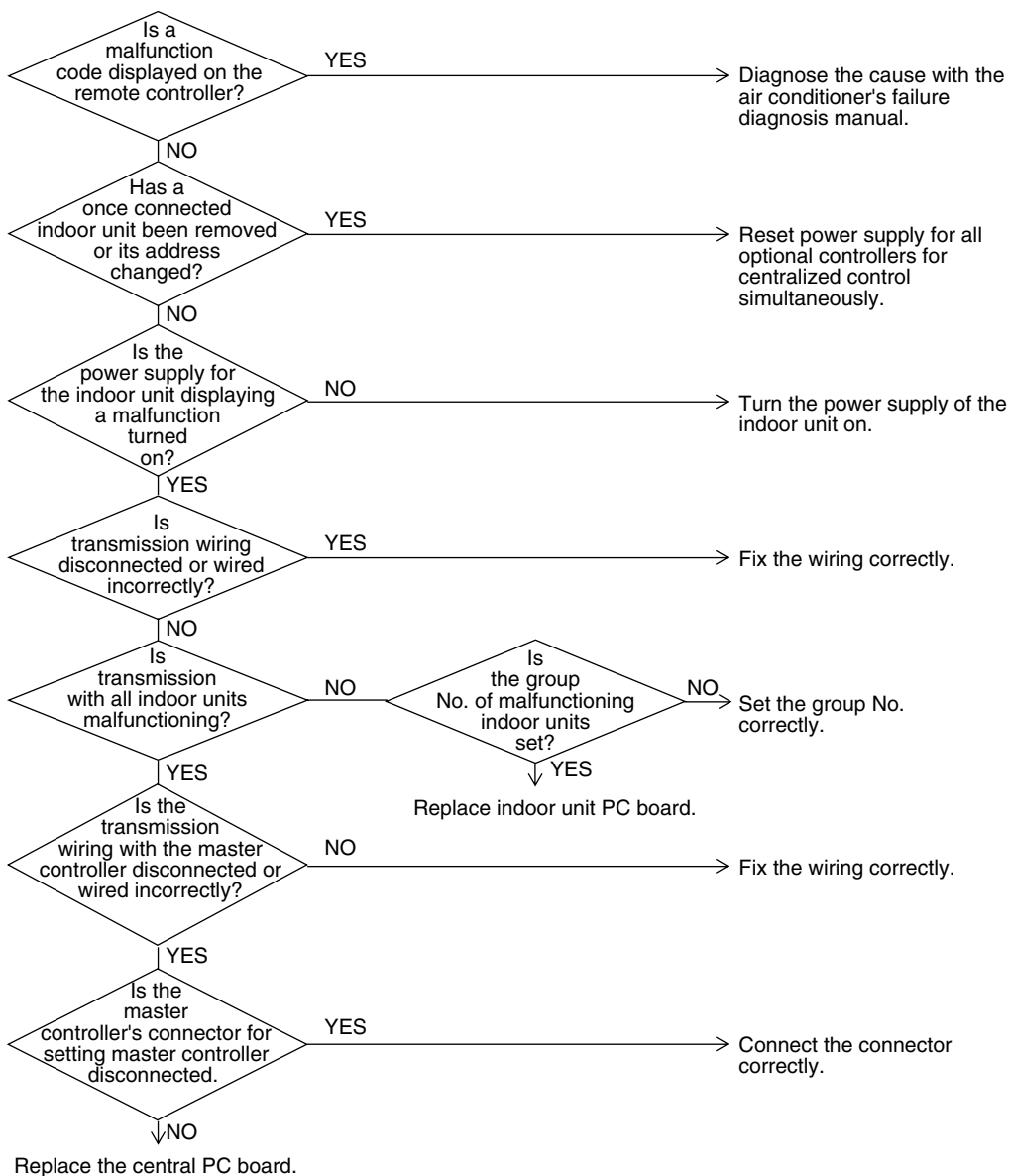

(V2841)

6.2 Display “Under Centralized Control” Blinks (Repeats Single Blink)

Remote Controller Display

 “under centralized control” (Repeats single blink)

Applicable Models

Unified ON/OFF controller
Central remote controller
Schedule timer

Method of Malfunction Detection

Detect the malfunction according to DIII-NET transmission data.

Malfunction Decision Conditions

When the centralized controller, which was connected once, shows no response.
The control ranges are overlapped.
When multiple master central controller are present.
When the schedule timer is set to individual use mode, other central controller is present.
When the wiring adaptor for electrical appendices is present.

Supposed Causes

- Address duplication of central remote controller
- Improper combination of optional controllers for centralized control
- Connection of more than one master controller
- Malfunction of transmission between optional controllers for centralized control
- Defect of PC board of optional controllers for centralized control

Troubleshooting



Caution

Be sure to turn off power switch before connect or disconnect connector, or parts damage may be occurred.

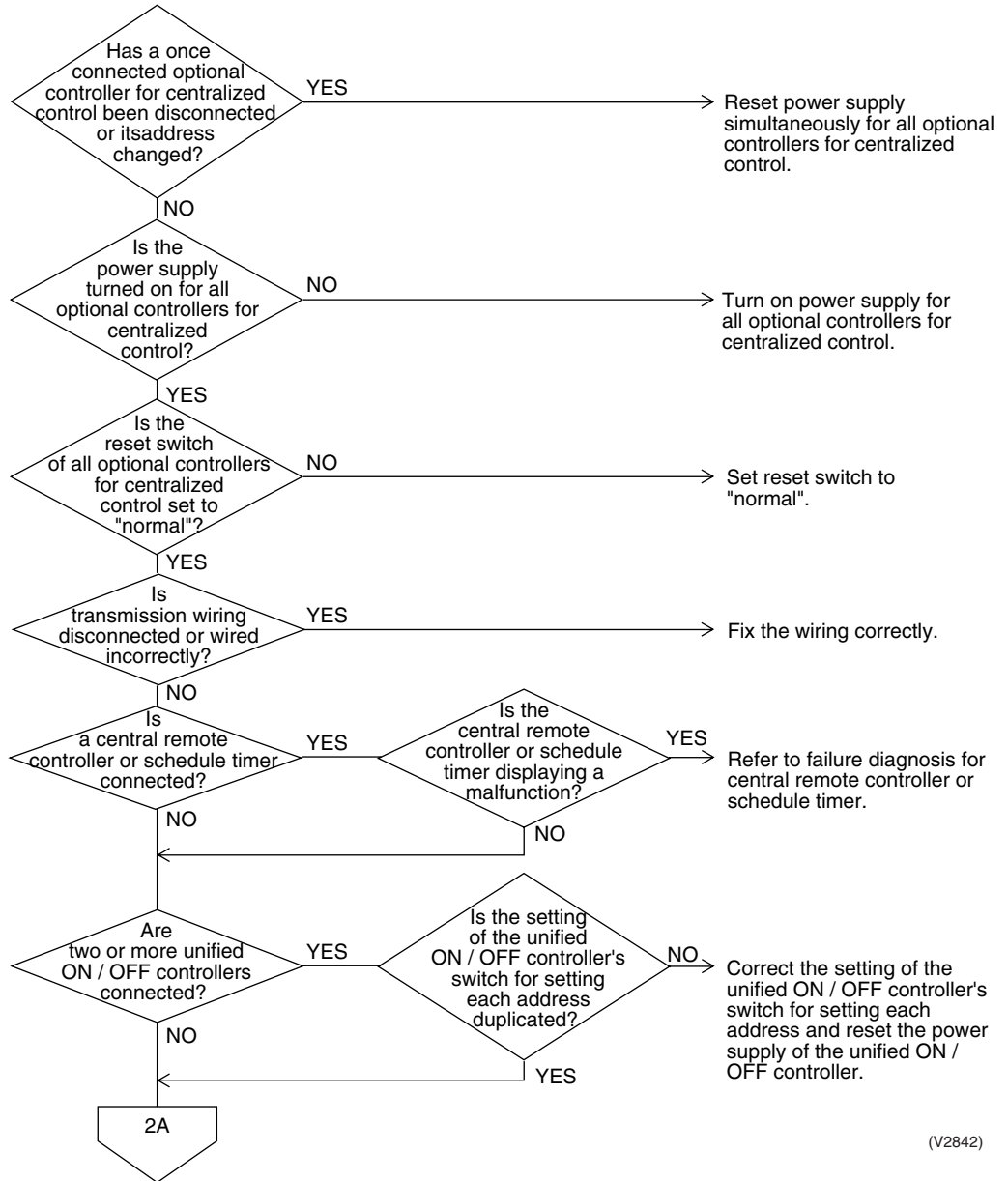

(V2842)

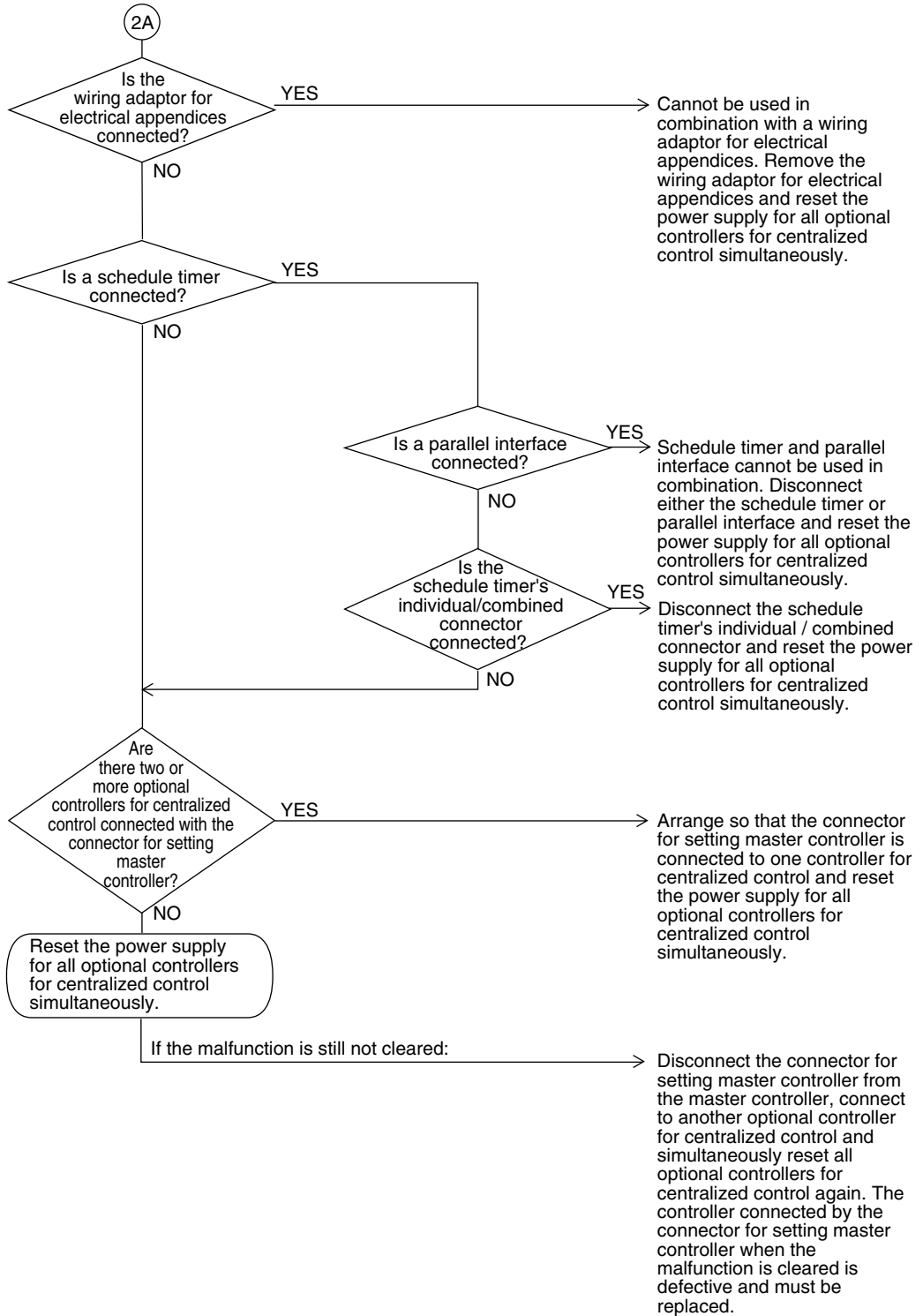

(V2843)

6.3 Display “Under Centralized Control” Blinks (Repeats Double Blink)

Remote Controller Display

⚠ “under centralized control” (Repeats double blink)

Applicable Models

Unified ON/OFF controller

Method of Malfunction Detection

Detect the malfunction according to DIII-NET transmission data.

Malfunction Decision Conditions

When no central control addresses are set to indoor units.
When no indoor units are connected within the control range.

Supposed Causes

- Central control address (group No.) is not set for indoor unit.
- Improper control range setting switch
- Improper wiring of transmission wiring

Troubleshooting



Caution

Be sure to turn off power switch before connect or disconnect connector, or parts damage may be occurred.

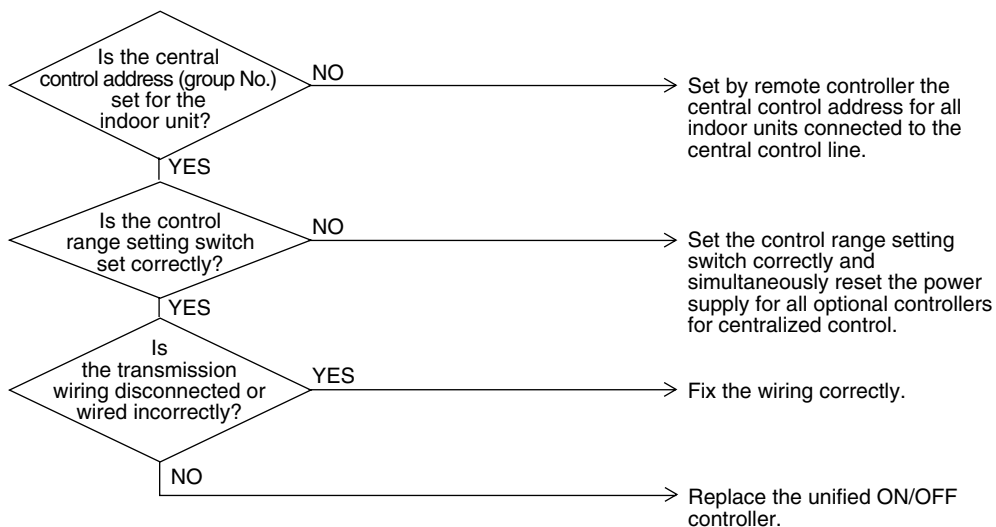

(V2844)

7. Troubleshooting (OP: Schedule Timer)

7.1 “UE” Malfunction of Transmission between Centralized Controller and Indoor Unit

Remote Controller Display	UE
Applicable Models	Schedule timer All models of indoor units
Method of Malfunction Detection	Microcomputer checks if transmission between indoor unit and centralized controller is normal.
Malfunction Decision Conditions	When transmission is not carried out normally for a certain amount of time
Supposed Causes	<ul style="list-style-type: none"> ■ Malfunction of transmission between central remote controller and indoor unit ■ Disconnection of connector for setting master controller (or individual/combined switching connector) ■ Defect of schedule timer PC board ■ Defect of indoor unit PC board

Troubleshooting

 **Caution** Be sure to turn off power switch before connect or disconnect connector, or parts damage may be occurred.

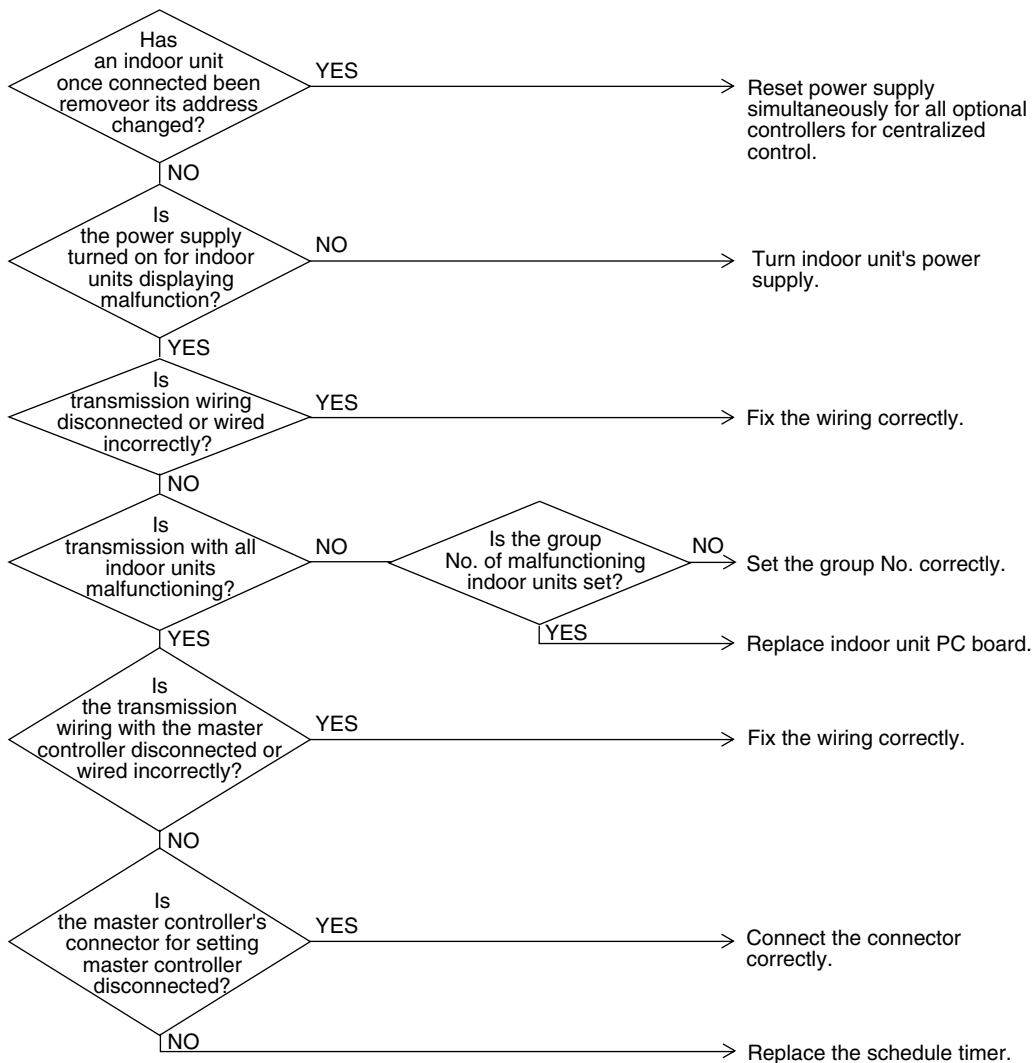

(V2836)

7.2 “M” PC Board Defect

Remote
Controller
Display

M

Applicable
Models

Schedule timer

Method of
Malfunction
Detection

Detect an abnormality in the DIII-NET polarity circuit.

Malfunction
Decision
Conditions

When + polarity and - polarity are detected at the same time.

Supposed
Causes

- Defect of schedule timer PC board

Troubleshooting



Caution

Be sure to turn off power switch before connect or disconnect connector, or parts damage may be occurred.

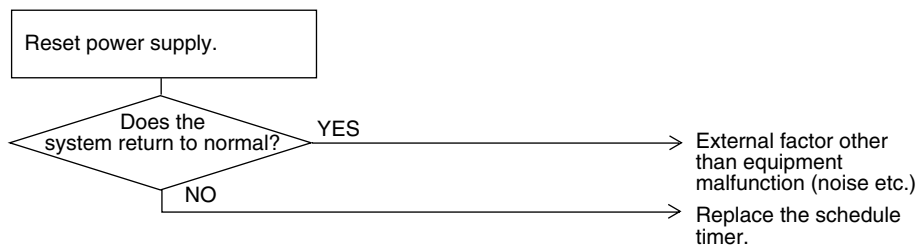

(V2837)

7.3 “M8” Malfunction of Transmission between Optional Controllers for Centralized Control

Remote Controller Display

M8

Applicable Models

Schedule timer

Method of Malfunction Detection

Detect the malfunction according to DIII-NET transmission data. (The system will be automatically reset.)

Malfunction Decision Conditions

When the optional controllers for centralized control, which was connected once, shows no response.

Supposed Causes

- Malfunction of transmission between optional controllers for centralized control
- Defect of PC board of optional controllers for centralized control

Troubleshooting



Caution

Be sure to turn off power switch before connect or disconnect connector, or parts damage may be occurred.

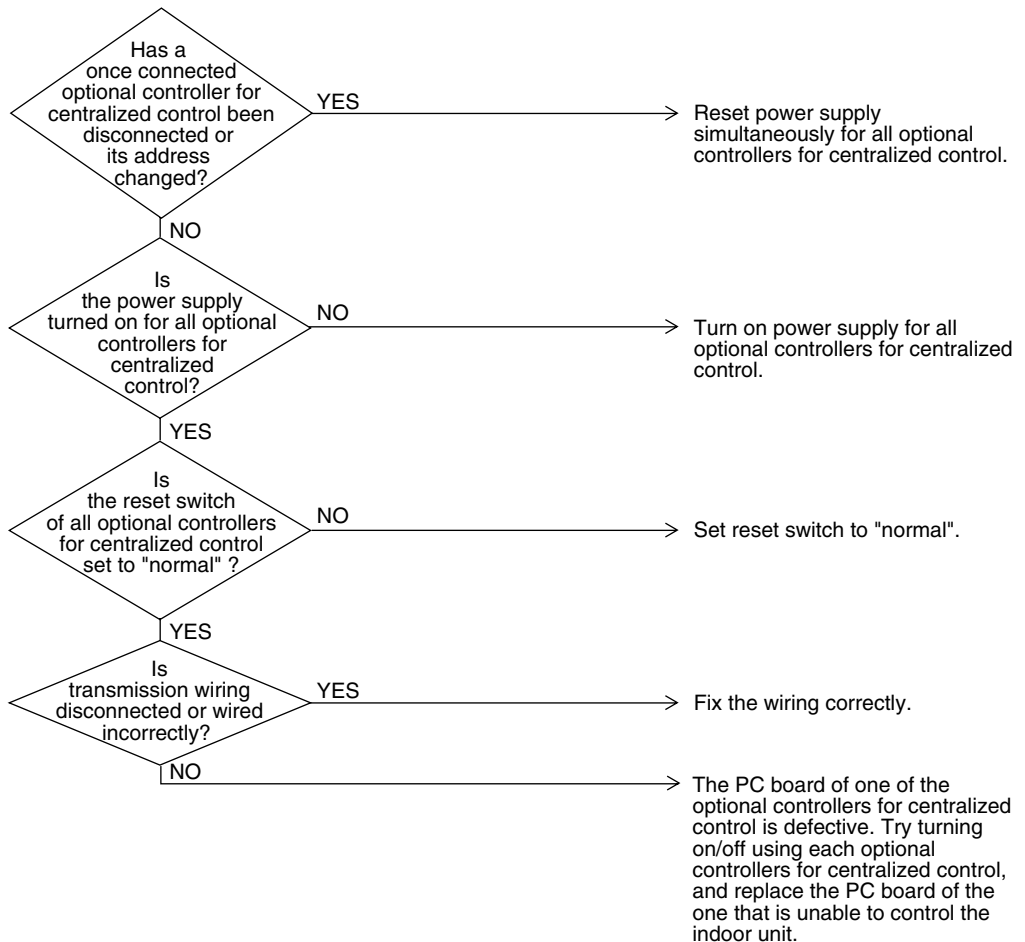

(V2838)

7.4 “MR” Improper Combination of Optional Controllers for Centralized Control

**Remote
Controller
Display**

MR

**Applicable
Models**

Schedule timer

**Method of
Malfunction
Detection**

Detect the malfunction according to DIII-NET transmission data.

**Malfunction
Decision
Conditions**

When the schedule timer is set to individual use mode, other central component is present.
When multiple master controllers are present.

**Supposed
Causes**

- Improper combination of optional controllers for centralized control
- More than one master controller is connected.
- Defect of PC board of optional controller for centralized control

Troubleshooting



Caution

Be sure to turn off power switch before connect or disconnect connector, or parts damage may be occurred.

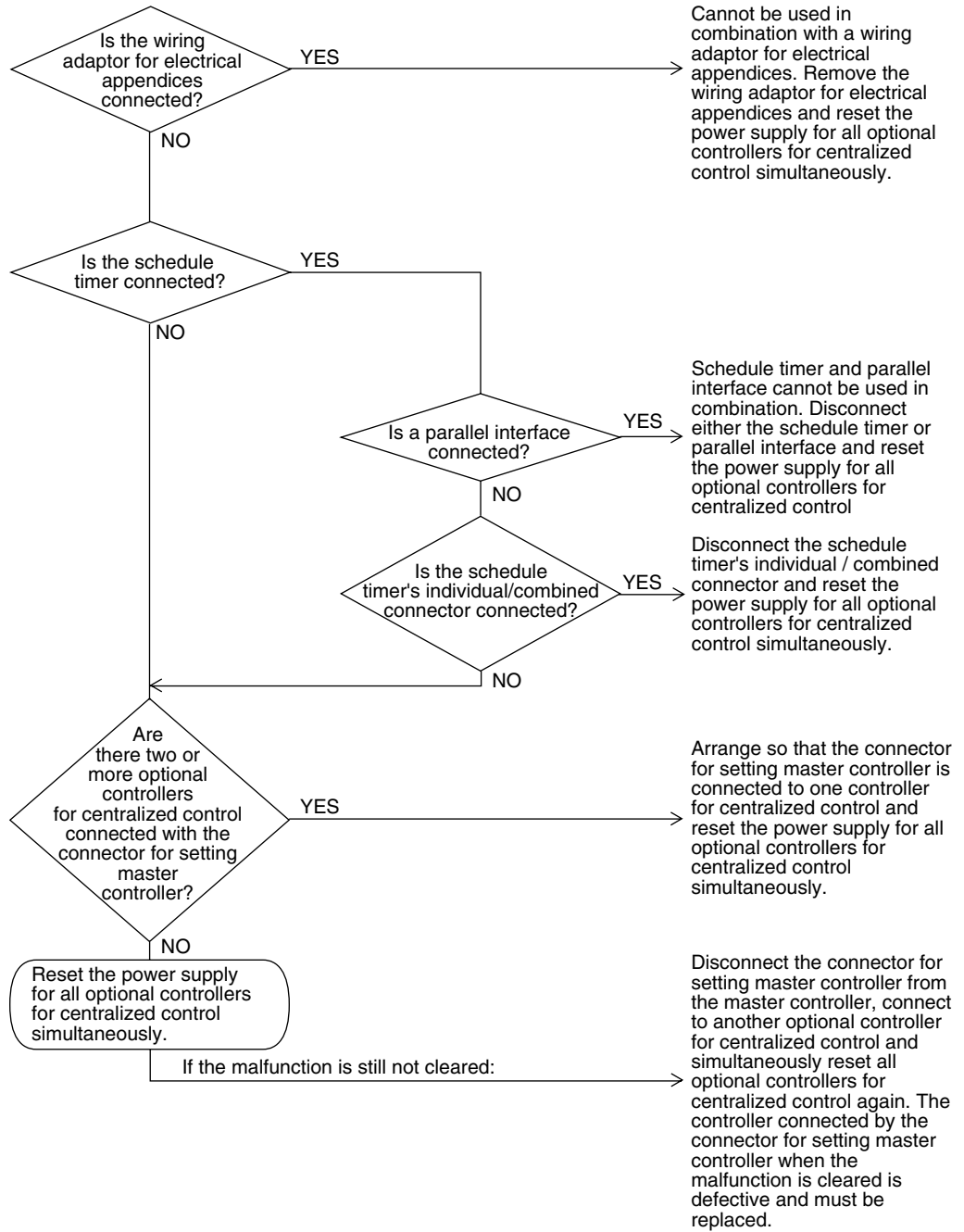

(V2839)

7.5 “MC” Address Duplication, Improper Setting

Remote
Controller
Display

MC

Applicable
Models

Schedule timer

Method of
Malfunction
Detection

Detect the malfunction according to DIII-NET transmission data.

Malfunction
Decision
Conditions

When two or more schedule timers are connected.

Supposed
Causes

- Address duplication of schedule timer

Troubleshooting



Caution

Be sure to turn off power switch before connect or disconnect connector, or parts damage may be occurred.



(V2840)

8. Check

Check No. 1

Check on connector of fan motor (Power supply cable)

(1) Turn off the power supply.

Measure the resistance between phases of U,V,W at the motor side connectors (three-core wire) to check that the values are balanced and there is no short circuiting, while connector or relay connector is disconnected.

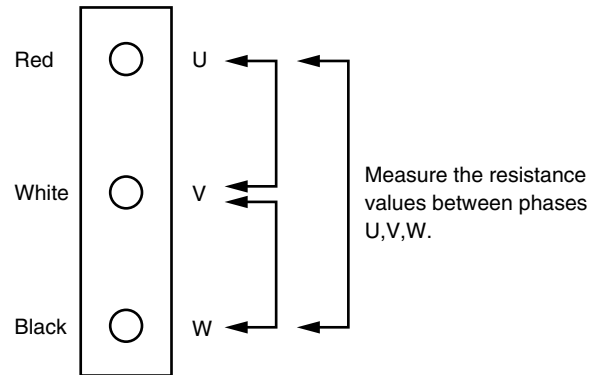

Check No. 2

Check for Fan Speed Pulse Input on Outdoor Unit PC Board

- (1) Disconnect the connector X206A with the power supply OFF and Operation OFF.
- (2) Is the voltage between pins 4 and 3 of X206A about 15 VDC after turning the power supply on?
- (3) Is the voltage between pins 4 and 1 of X206A about 5 VDC?
- (4) Connect the connector X206A with the power supply OFF and Operation OFF.
- (5) When making one turn of the upper fan motor by hand after turning the power supply on, is a pulse (0 and 5 V) generated 4 times between pins 4 and 1 of X206A? (Measure at the contact terminal on the harness side with the connector connected.)
- (6) Disconnect the connector X207A with the power supply OFF and Operation OFF.
- (7) Is the voltage between pins 4 and 3 of X207A about 15 VDC after turning the power supply on?
- (8) Is the voltage between pins 4 and 1 of X207A about 5 VDC?
- (9) Connect the connector X207A with the power supply OFF and Operation OFF.
- (10) When making one turn of the lower fan motor by hand after turning the power supply on, is a pulse (0 and 5 V) generated 4 times between pins 4 and 1 of X207A?

-
- (2) (7): NO → Faulty PC board → Replace the PC board.
 (3) (8): NO → Faulty PC board → Replace the PC board.
 (5)(10): NO → Faulty hall IC → Replace the DC fan motor.
 (2) (3) (5) (7) (8) (10): YES → Replace the PC board.
-

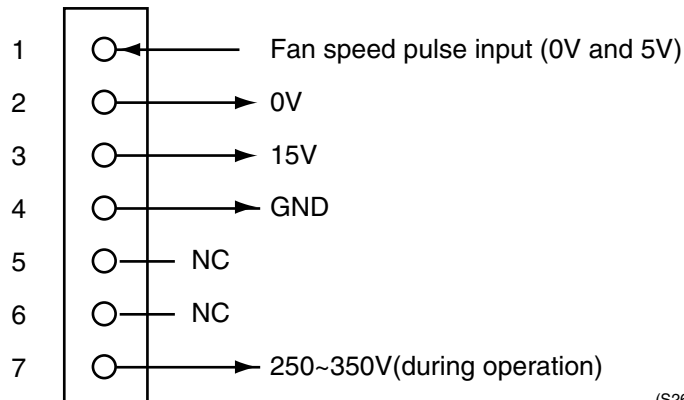

(S2679)

Part 8

Appendix

- 1. Piping Diagrams.....174
 - 1.1 Outdoor Unit..... 174
 - 1.2 Indoor Unit 175
- 2. Wiring Diagrams for Reference.....176
 - 2.1 Outdoor Unit..... 176
 - 2.2 Indoor Unit 177
- 3. Thermistor Resistance / Temperature Characteristics..... 179
- 4. Pressure Sensor181

1. Piping Diagrams

1.1 Outdoor Unit

RZQ24MVJU
 RZQ30MVJU
 RZQ36MVJU
 RZQ42MVJU

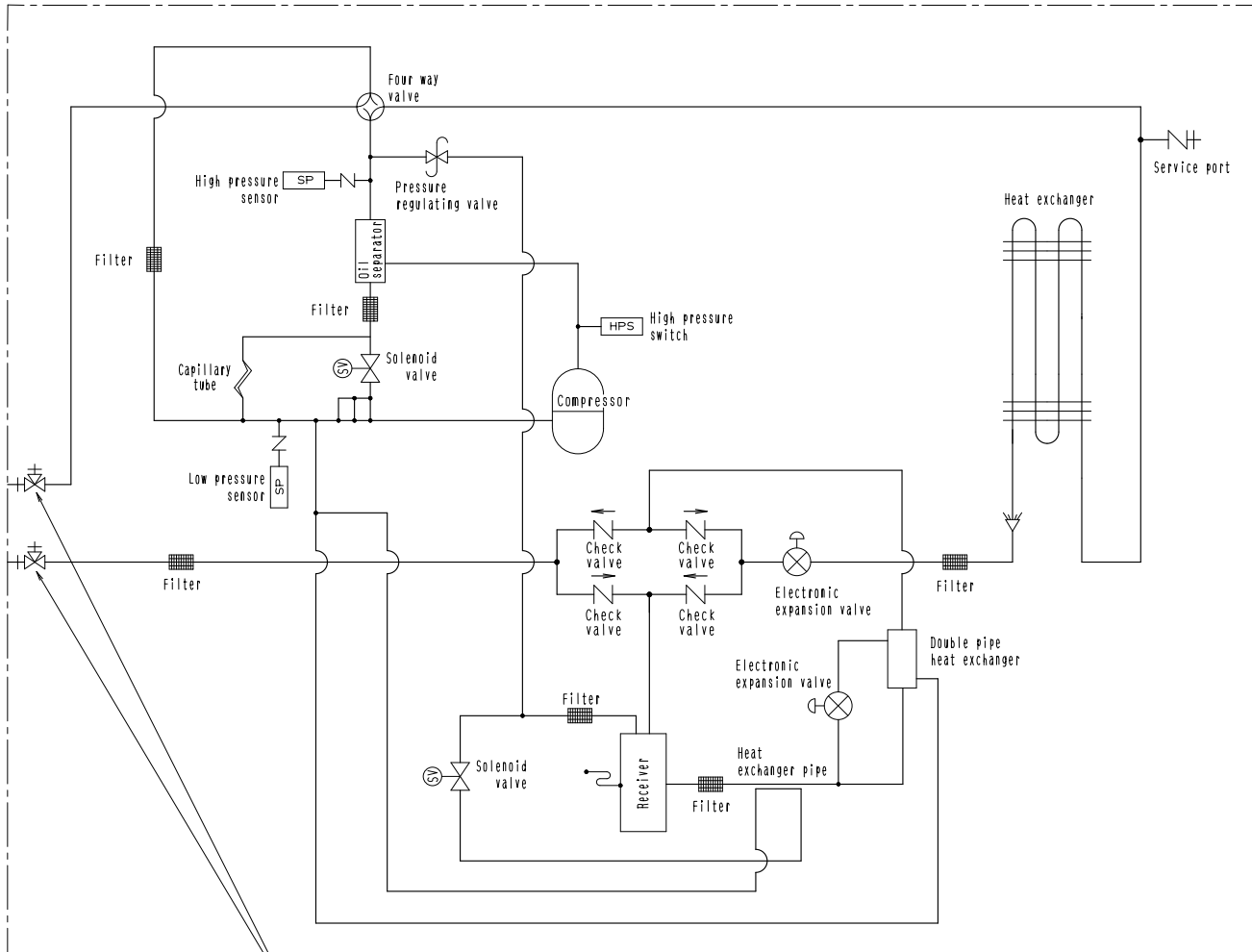

Stop valve (With service port on field piping side $\phi 5/16$ flare connection)

3D047385

1.2 Indoor Unit

FCQ24M / 30M / 36M / 42MVJU
 FHQ24M / 30M / 36M / 42MVJU

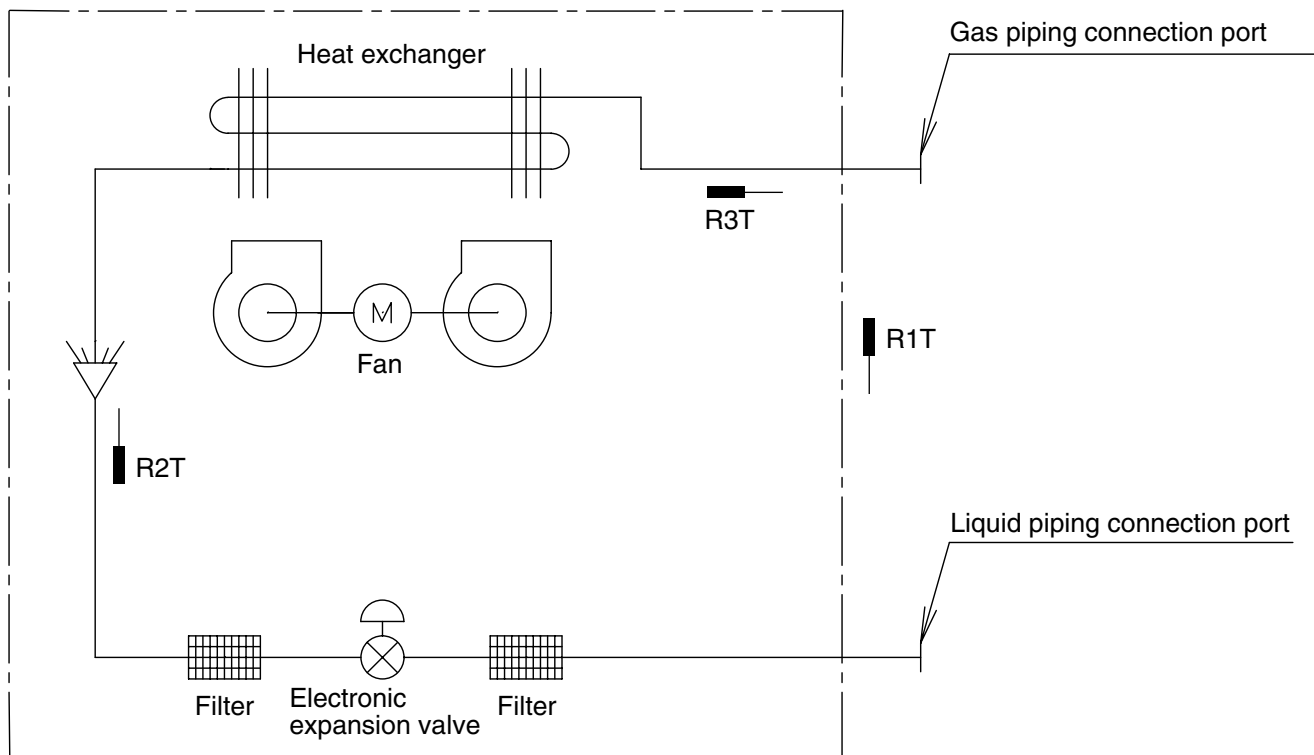

C:4D024460

- R1T : Thermistor for suction air temperature
- R2T : Thermistor for liquid line temperature
- R3T : Thermistor for gas line temperature

(in)

Capacity	GAS	Liquid
24/30/36/42M	φ5/8	φ3/8

2. Wiring Diagrams for Reference

2.1 Outdoor Unit

RZQ24MVJU
RZQ30MVJU
RZQ36MVJU
RZQ42MVJU

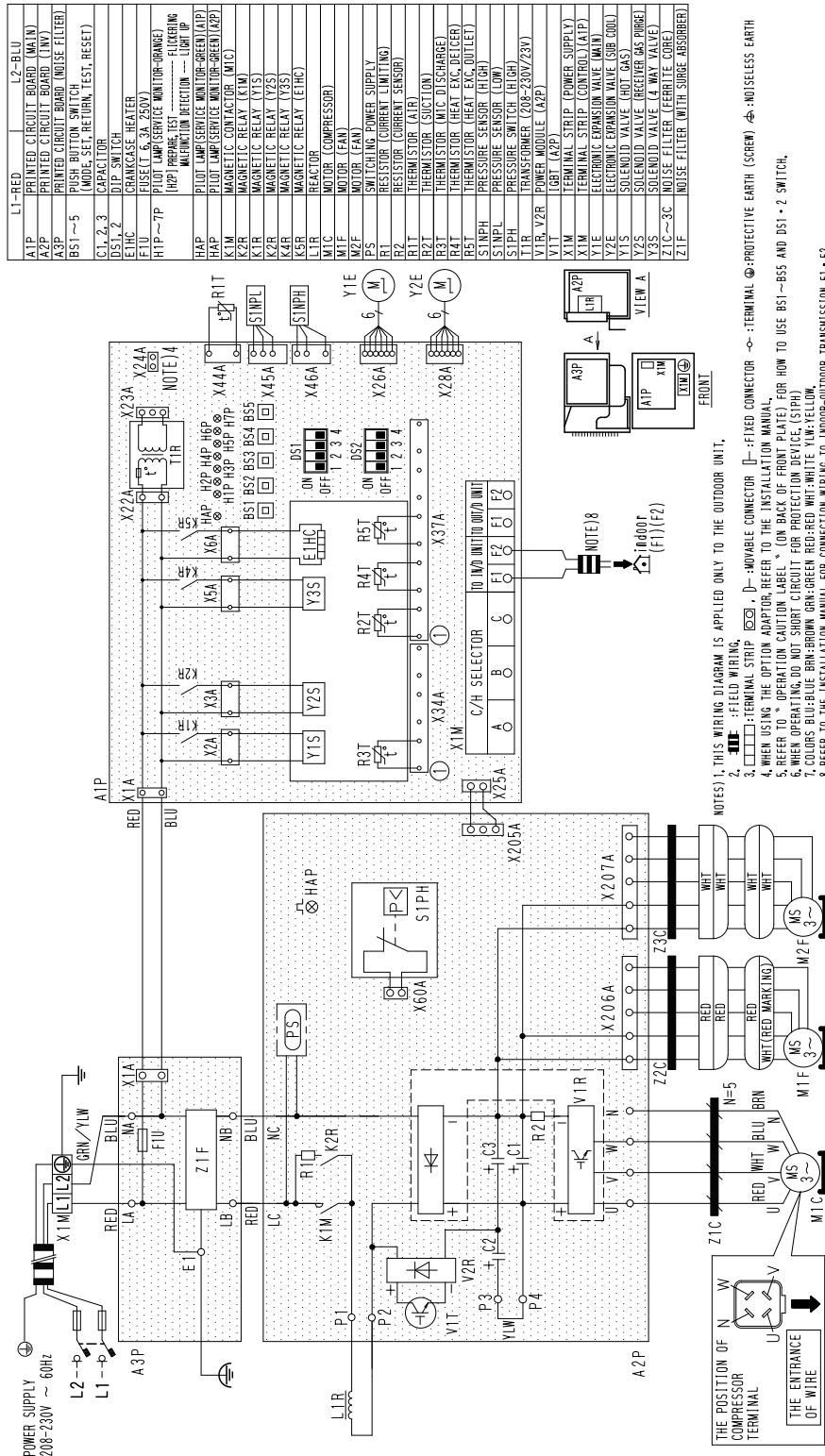

3D047896B

2.2 Indoor Unit

FCQ24MVJU
 FCQ30MVJU
 FCQ36MVJU
 FCQ42MVJU

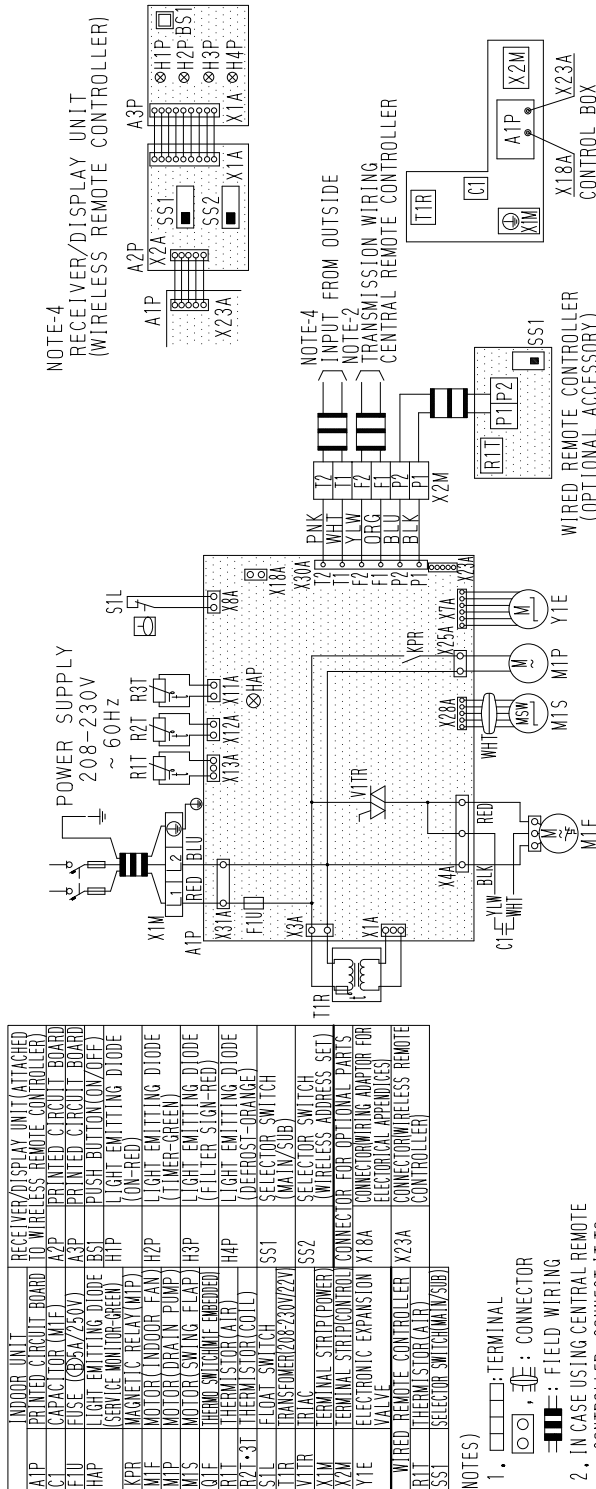

INDOOR UNIT	RECEIVER/DISPLAY UNIT (ATTACHED)
A1P	PRINTED CIRCUIT BOARD
C1	CAPACITOR (M/F)
F1U	FUSE (CBAZ/250V)
HAP	HAP (SERV OF MOTOR-GREEN)
KPR	KEY (SERV OF MOTOR-GREEN)
M1F	MOTOR (INDOOR FAN)
M1S	MOTOR (DRAIN PUMP)
M1T	MOTOR (SWING FLAP)
O1F	OVER CURRENT PROTECTIVE DEVICE
R1T	RELAY (THERMISTOR)
R2T	RELAY (THERMISTOR)
R3T	RELAY (THERMISTOR)
S11	SELECTOR SWITCH
S12	SELECTOR SWITCH
S13	SELECTOR SWITCH
S14	SELECTOR SWITCH
S15	SELECTOR SWITCH
S16	SELECTOR SWITCH
S17	SELECTOR SWITCH
S18	SELECTOR SWITCH
S19	SELECTOR SWITCH
S20	SELECTOR SWITCH
S21	SELECTOR SWITCH
S22	SELECTOR SWITCH
S23	SELECTOR SWITCH
S24	SELECTOR SWITCH
S25	SELECTOR SWITCH
S26	SELECTOR SWITCH
S27	SELECTOR SWITCH
S28	SELECTOR SWITCH
S29	SELECTOR SWITCH
S30	SELECTOR SWITCH
S31	SELECTOR SWITCH
S32	SELECTOR SWITCH
S33	SELECTOR SWITCH
S34	SELECTOR SWITCH
S35	SELECTOR SWITCH
S36	SELECTOR SWITCH
S37	SELECTOR SWITCH
S38	SELECTOR SWITCH
S39	SELECTOR SWITCH
S40	SELECTOR SWITCH
S41	SELECTOR SWITCH
S42	SELECTOR SWITCH
S43	SELECTOR SWITCH
S44	SELECTOR SWITCH
S45	SELECTOR SWITCH
S46	SELECTOR SWITCH
S47	SELECTOR SWITCH
S48	SELECTOR SWITCH
S49	SELECTOR SWITCH
S50	SELECTOR SWITCH
S51	SELECTOR SWITCH
S52	SELECTOR SWITCH
S53	SELECTOR SWITCH
S54	SELECTOR SWITCH
S55	SELECTOR SWITCH
S56	SELECTOR SWITCH
S57	SELECTOR SWITCH
S58	SELECTOR SWITCH
S59	SELECTOR SWITCH
S60	SELECTOR SWITCH
S61	SELECTOR SWITCH
S62	SELECTOR SWITCH
S63	SELECTOR SWITCH
S64	SELECTOR SWITCH
S65	SELECTOR SWITCH
S66	SELECTOR SWITCH
S67	SELECTOR SWITCH
S68	SELECTOR SWITCH
S69	SELECTOR SWITCH
S70	SELECTOR SWITCH
S71	SELECTOR SWITCH
S72	SELECTOR SWITCH
S73	SELECTOR SWITCH
S74	SELECTOR SWITCH
S75	SELECTOR SWITCH
S76	SELECTOR SWITCH
S77	SELECTOR SWITCH
S78	SELECTOR SWITCH
S79	SELECTOR SWITCH
S80	SELECTOR SWITCH
S81	SELECTOR SWITCH
S82	SELECTOR SWITCH
S83	SELECTOR SWITCH
S84	SELECTOR SWITCH
S85	SELECTOR SWITCH
S86	SELECTOR SWITCH
S87	SELECTOR SWITCH
S88	SELECTOR SWITCH
S89	SELECTOR SWITCH
S90	SELECTOR SWITCH
S91	SELECTOR SWITCH
S92	SELECTOR SWITCH
S93	SELECTOR SWITCH
S94	SELECTOR SWITCH
S95	SELECTOR SWITCH
S96	SELECTOR SWITCH
S97	SELECTOR SWITCH
S98	SELECTOR SWITCH
S99	SELECTOR SWITCH
S100	SELECTOR SWITCH

- NOTES
1. [Symbol] : TERMINAL
 [Symbol] : CONNECTOR
 [Symbol] : FIELD WIRING
 2. IN CASE USING CENTRAL REMOTE CONTROLLER, CONNECT IT TO THE UNIT IN ACCORDANCE WITH THE ATTACHED INSTRUCTION MANUAL.
 3. X23A IS CONNECTED WHEN THE WIRELESS REMOTE CONTROLLER KIT IS BEING USED.
 4. WHEN CONNECTING THE INPUT WIRES FROM OUTSIDE, FORCED OFF OR ON/OFF CONTROL OPERATION CAN BE SELECTED BY REMOTE CONTROLLER.
- IN DETAILS, REFER TO THE INSTALLATION MANUAL ATTACHED THE UNIT.
5. SYMBOLS SHOW AS FOLLOWS
 (BLK:BLACK BLU:BLUE ORG:ORANGE PNK:PINK
 RED:RED WHT:WHITE YLW:YELLOW)
6. USE COPPER CONDUCTORS ONLY.

3D042620B

FHQ24MVJU
 FHQ30MVJU
 FHQ36MVJU
 FHQ42MVJU

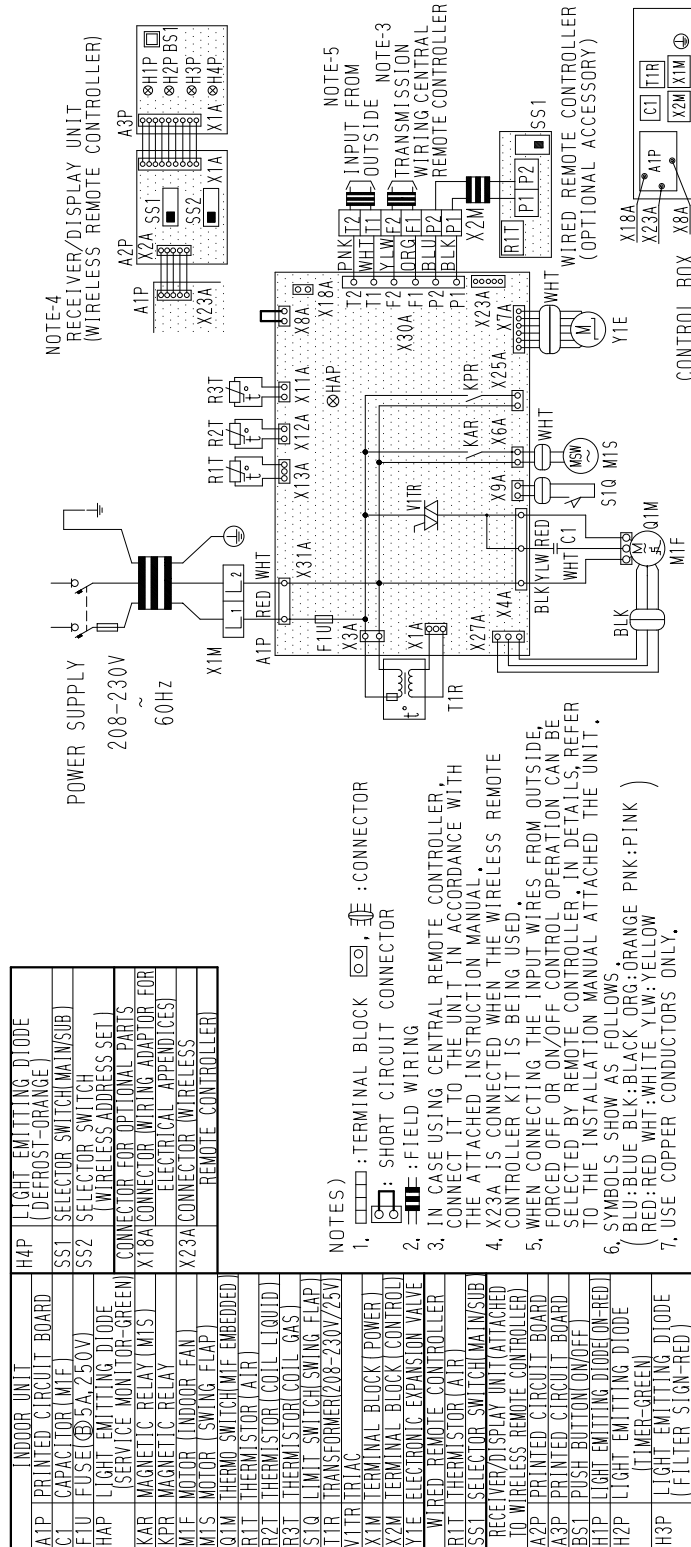

3. Thermistor Resistance / Temperature Characteristics

Indoor unit For air suction R1T
 For liquid pipe R2T
 For gas pipe R3T

Outdoor unit for fin thermistor R1T

Outdoor unit For outdoor air R1T
 For coil R2T
 For suction pipe R4T
 For Receiver gas pipe R5T

T°F	T°C	kΩ
14	-10	—
18	-8	—
21	-6	88.0
25	-4	79.1
28	-2	71.1
32	0	64.1
35	2	57.8
39	4	52.3
43	6	47.3
46	8	42.9
50	10	38.9
54	12	35.3
57	14	32.1
61	16	29.2
64	18	26.6
68	20	24.3
72	22	22.2
75	24	20.3
79	26	18.5
82	28	17.0
86	30	15.6
90	32	14.2
93	34	13.1
97	36	12.0
100	38	11.1
104	40	10.3
108	42	9.5
111	44	8.8
115	46	8.2
118	48	7.6
122	50	7.0
126	52	6.7
129	54	6.0
133	56	5.5
136	58	5.2
140	60	4.79
144	62	4.46
147	64	4.15
151	66	3.87
154	68	3.61
158	70	3.37
162	72	3.15
165	74	2.94
169	76	2.75
172	78	2.51
176	80	2.41
180	82	2.26
183	84	2.12
187	86	1.99
190	88	1.87
194	90	1.76
198	92	1.65
201	94	1.55
205	96	1.46
208	98	1.38

T°F	T°C	kΩ
-4.0	-20	197.81
-2.2	-19	186.53
-0.4	-18	175.97
1.4	-17	166.07
3.2	-16	156.80
5.0	-15	148.10
6.8	-14	139.94
8.6	-13	132.28
10.4	-12	125.09
12.2	-11	118.34
14.0	-10	111.99
15.8	-9	106.03
17.6	-8	100.41
19.4	-7	95.14
21.2	-6	90.17
23.0	-5	85.49
24.8	-4	81.08
26.6	-3	76.93
28.4	-2	73.01
30.2	-1	69.32
32.0	0	65.84
33.8	1	62.54
35.6	2	59.43
37.4	3	56.49
39.2	4	53.71
41.0	5	51.09
42.8	6	48.61
44.6	7	46.26
46.4	8	44.05
48.2	9	41.95
50.0	10	39.96
51.8	11	38.08
53.6	12	36.30
55.4	13	34.62
57.2	14	33.02
59.0	15	31.50
60.8	16	30.06
62.6	17	28.70
64.4	18	27.41
66.2	19	26.18
68.0	20	25.01
69.8	21	23.91
71.6	22	22.85
73.4	23	21.85
75.2	24	20.90
77.0	25	20.00
78.8	26	19.14
80.6	27	18.32
82.4	28	17.54
84.2	29	16.80
86.0	30	16.10

T°F	T°C	kΩ
86.0	30	16.10
87.8	31	15.43
89.6	32	14.79
91.4	33	14.18
93.2	34	13.59
95.0	35	13.04
96.8	36	12.51
98.6	37	12.01
100.4	38	11.52
102.2	39	11.06
104.0	40	10.63
105.8	41	10.21
107.6	42	9.81
109.4	43	9.42
111.2	44	9.06
113.0	45	8.71
114.8	46	8.37
116.6	47	8.05
118.4	48	7.75
120.2	49	7.46
122.0	50	7.18
123.8	51	6.91
125.6	52	6.65
127.4	53	6.41
129.2	54	6.65
131.0	55	6.41
132.8	56	6.18
134.6	57	5.95
136.4	58	5.74
138.2	59	5.14
140.0	60	4.96
141.8	61	4.79
143.6	62	4.62
145.4	63	4.46
147.2	64	4.30
149.0	65	4.16
150.8	66	4.01
152.6	67	3.88
154.4	68	3.75
156.2	69	3.62
158.0	70	3.50
159.8	71	3.38
161.6	72	3.27
163.4	73	3.16
165.2	74	3.06
167.0	75	2.96
168.8	76	2.86
170.6	77	2.77
172.4	78	2.68
174.2	79	2.60
176.0	80	2.51

**Outdoor Unit
Thermistors for
Discharge Pipe
(R3T)**

T°F	T°C	kΩ
32.0	0	640.44
33.8	1	609.31
35.6	2	579.96
37.4	3	552.00
39.2	4	525.63
41.0	5	500.66
42.8	6	477.01
44.6	7	454.60
46.4	8	433.37
48.2	9	413.24
50.0	10	394.16
51.8	11	376.05
53.6	12	358.88
55.4	13	342.58
57.2	14	327.10
59.0	15	312.41
60.8	16	298.45
62.6	17	285.18
64.4	18	272.58
66.2	19	260.60
68.0	20	249.00
69.8	21	238.36
71.6	22	228.05
73.4	23	218.24
75.2	24	208.90
77.0	25	200.00
78.8	26	191.53
80.6	27	183.46
82.4	28	175.77
84.2	29	168.44
86.0	30	161.45
86.0	31	154.79
87.8	32	148.43
89.6	33	142.37
91.4	34	136.59
93.2	35	131.06
95.0	36	125.79
96.8	37	120.76
98.6	38	115.95
100.4	39	111.35
102.2	40	106.96
104.0	41	102.76
105.8	42	98.75
107.6	43	94.92
109.4	44	91.25
111.2	45	87.74
113.0	46	84.38
114.8	47	81.16
116.6	48	78.09
118.4	49	75.14
120.2	50	72.32

T°F	T°C	kΩ
122.0	50	72.32
123.8	51	69.64
125.6	52	67.06
127.4	53	64.60
129.2	54	62.24
131.0	55	59.97
132.8	56	57.80
134.6	57	55.72
136.4	58	53.72
138.2	59	51.98
140.0	60	49.96
141.8	61	48.19
143.6	62	46.49
145.4	63	44.86
147.2	64	43.30
149.0	65	41.79
150.8	66	40.35
152.6	67	38.96
154.4	68	37.63
156.2	69	36.34
158.0	70	35.11
159.8	71	33.92
161.6	72	32.78
163.4	73	31.69
165.2	74	30.63
167.0	75	29.61
168.8	76	28.64
170.6	77	27.69
172.4	78	26.79
174.2	79	25.91
176.0	80	25.07
177.8	81	24.26
179.6	82	23.48
181.4	83	22.73
183.2	84	22.01
185.0	85	21.31
186.8	86	20.63
188.6	87	19.98
190.4	88	19.36
192.2	89	18.75
194.0	90	18.17
195.8	91	17.61
197.6	92	17.07
199.4	93	16.54
201.2	94	16.04
203.0	95	15.55
204.8	96	15.08
206.6	97	14.62
208.4	98	14.18
210.2	99	13.76
212.0	100	13.35

T°F	T°C	kΩ
212.0	100	13.35
213.8	101	12.95
215.6	102	12.57
217.4	103	12.20
219.2	104	11.84
221.0	105	11.49
222.8	106	11.15
224.6	107	10.83
226.4	108	10.52
228.2	109	10.21
230.0	110	9.92
231.8	111	9.64
233.6	112	9.36
235.4	113	9.10
237.2	114	8.84
239.0	115	8.59
240.8	116	8.35
242.6	117	8.12
244.4	118	7.89
246.2	119	7.68
248.0	120	7.47
249.8	121	7.26
251.6	122	7.06
253.4	123	6.87
255.2	124	6.69
257.0	125	6.51
258.8	126	6.33
260.6	127	6.16
262.4	128	6.00
264.2	129	5.84
266.0	130	5.69
267.8	131	5.54
269.6	132	5.39
271.4	133	5.25
273.2	134	5.12
275.0	135	4.98
276.8	136	4.86
278.6	137	4.73
280.4	138	4.61
282.2	139	4.49
284.0	140	4.38
285.8	141	4.27
287.6	142	4.16
289.4	143	4.06
291.2	144	3.96
293.0	145	3.86
294.8	146	3.76
296.6	147	3.67
298.4	148	3.58
300.2	149	3.49
302.0	150	3.41

4. Pressure Sensor

$P_H = 1.38V - 0.69$
 $P_L = 0.57V - 0.28$
 P_H : High pressure
 P_L : Low pressure
 V : Voltage (V)

P_H : Detected Pressure [High Side]
 P_L : Detected Pressure [Low Side]
 V_H : Output Voltage [High Side] V_{DC}
 V_L : Output Voltage [Low Side] V_{DC}

Detected Pressure

P_H, P_L
 (psi) MPa

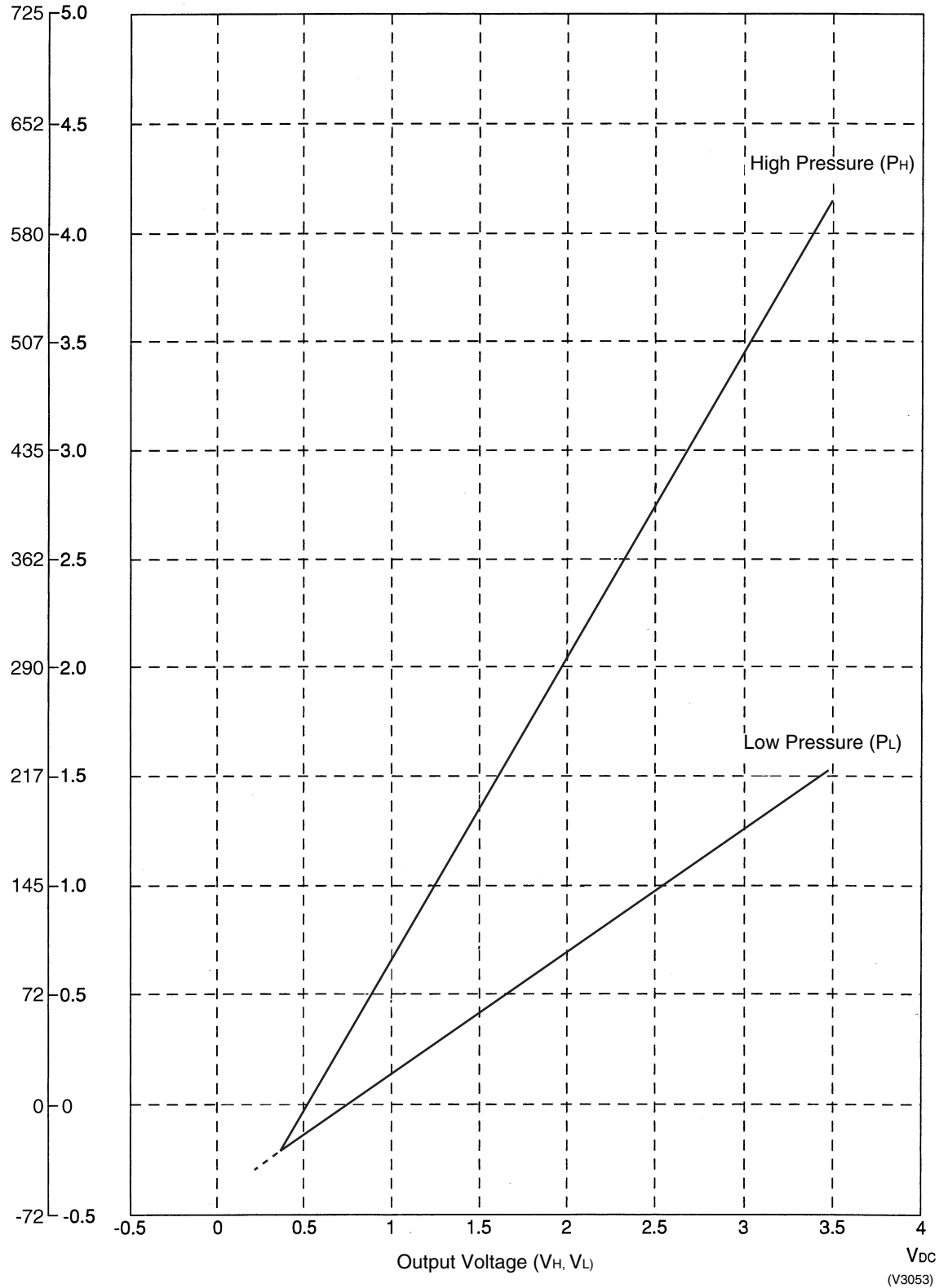

Part 9

Precautions for New Refrigerant (R-410A)

1. Precautions for New Refrigerant (R-410A)	184
1.1 Outline.....	184
1.2 Service Tools	186

1. Precautions for New Refrigerant (R-410A)

1.1 Outline

1.1.1 About Refrigerant R-410A

- Characteristics of new refrigerant, R-410A
 1. Performance
Almost the same performance as R-22 and R-407C
 2. Pressure
Working pressure is approx. 1.4 times more than R-22 and R-407C.
 3. Refrigerant composition
Few problems in composition control, since it is a Quasi-azeotropic mixture refrigerant.

	HFC units (Units using new refrigerants)		HCFC units
Refrigerant name	R-407C	R-410A	R-22
Composing substances	Non-azeotropic mixture of HFC32, HFC125 and HFC134a (*1)	Quasi-azeotropic mixture of HFC32 and JFC125 (*1)	Single-component refrigerant
Design pressure	3.2 MPa (gauge pressure) = 32.6 kgf/cm ² = 464 psi	4.0 MPa (gauge pressure) = 40.8 kgf/cm ² = 580 psi	2.75MPa (gauge pressure) = 28.0 kgf/cm ² = 399 psi
Refrigerant oil	Synthetic oil (Ether)		Mineral oil (Suniso)
Ozone destruction factor (ODP)	0	0	0.05
Combustibility	None	None	None
Toxicity	None	None	None

- ★1. Non-azeotropic mixture refrigerant: mixture of two or more refrigerants having different boiling points.
- ★2. Quasi-azeotropic mixture refrigerant: mixture of two or more refrigerants having similar boiling points.
- ★3. The design pressure is different at each product. Please refer to the installation manual for each product.

(Reference) 1 MPa ≙ 10.19716 kgf / cm²
1 MPa ≙ 145 psi

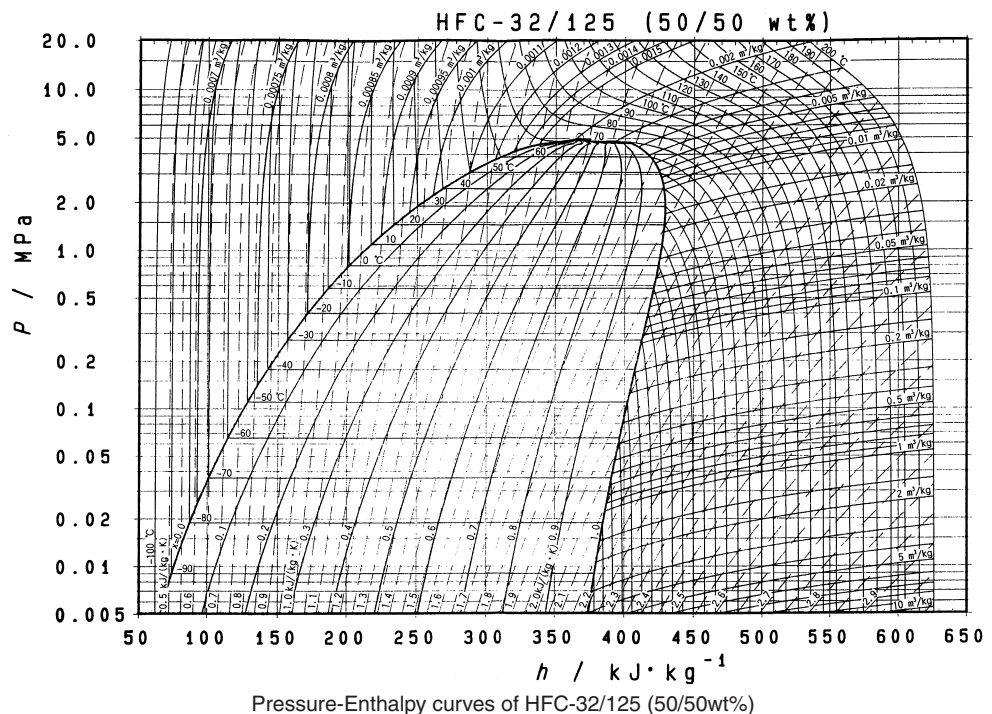

■ Thermodynamic characteristic of R-410A

DAIREP ver2.0

Temperature (°C)	Steam pressure (kPa)		Density (kg/m ³)		Specific heat at constant pressure (kJ/kgK)		Specific enthalpy (kJ/kg)		Specific entropy (kJ/KgK)	
	Liquid	Vapor	Liquid	Vapor	Liquid	Vapor	Liquid	Vapor	Liquid	Vapor
-70	36.13	36.11	1410.7	1.582	1.372	0.695	100.8	390.6	0.649	2.074
-68	40.83	40.80	1404.7	1.774	1.374	0.700	103.6	391.8	0.663	2.066
-66	46.02	45.98	1398.6	1.984	1.375	0.705	106.3	393.0	0.676	2.058
-64	51.73	51.68	1392.5	2.213	1.377	0.710	109.1	394.1	0.689	2.051
-62	58.00	57.94	1386.4	2.463	1.378	0.715	111.9	395.3	0.702	2.044
-60	64.87	64.80	1380.2	2.734	1.379	0.720	114.6	396.4	0.715	2.037
-58	72.38	72.29	1374.0	3.030	1.380	0.726	117.4	397.6	0.728	2.030
-56	80.57	80.46	1367.8	3.350	1.382	0.732	120.1	398.7	0.741	2.023
-54	89.49	89.36	1361.6	3.696	1.384	0.737	122.9	399.8	0.754	2.017
-52	99.18	99.03	1355.3	4.071	1.386	0.744	125.7	400.9	0.766	2.010
-51.58	101.32	101.17	1354.0	4.153	1.386	0.745	126.3	401.1	0.769	2.009
-50	109.69	109.51	1349.0	4.474	1.388	0.750	128.5	402.0	0.779	2.004
-48	121.07	120.85	1342.7	4.909	1.391	0.756	131.2	403.1	0.791	1.998
-46	133.36	133.11	1336.3	5.377	1.394	0.763	134.0	404.1	0.803	1.992
-44	146.61	146.32	1330.0	5.880	1.397	0.770	136.8	405.2	0.816	1.987
-42	160.89	160.55	1323.5	6.419	1.401	0.777	139.6	406.2	0.828	1.981
-40	176.24	175.85	1317.0	6.996	1.405	0.785	142.4	407.3	0.840	1.976
-38	192.71	192.27	1310.5	7.614	1.409	0.792	145.3	408.3	0.852	1.970
-36	210.37	209.86	1304.0	8.275	1.414	0.800	148.1	409.3	0.864	1.965
-34	229.26	228.69	1297.3	8.980	1.419	0.809	150.9	410.2	0.875	1.960
-32	249.46	248.81	1290.6	9.732	1.424	0.817	153.8	411.2	0.887	1.955
-30	271.01	270.28	1283.9	10.53	1.430	0.826	156.6	412.1	0.899	1.950
-28	293.99	293.16	1277.1	11.39	1.436	0.835	159.5	413.1	0.911	1.946
-26	318.44	317.52	1270.2	12.29	1.442	0.844	162.4	414.0	0.922	1.941
-24	344.44	343.41	1263.3	13.26	1.448	0.854	165.3	414.9	0.934	1.936
-22	372.05	370.90	1256.3	14.28	1.455	0.864	168.2	415.7	0.945	1.932
-20	401.34	400.06	1249.2	15.37	1.461	0.875	171.1	416.6	0.957	1.927
-18	432.36	430.95	1242.0	16.52	1.468	0.886	174.1	417.4	0.968	1.923
-16	465.20	463.64	1234.8	17.74	1.476	0.897	177.0	418.2	0.980	1.919
-14	499.91	498.20	1227.5	19.04	1.483	0.909	180.0	419.0	0.991	1.914
-12	536.58	534.69	1220.0	20.41	1.491	0.921	182.9	419.8	1.003	1.910
-10	575.26	573.20	1212.5	21.86	1.499	0.933	185.9	420.5	1.014	1.906
-8	616.03	613.78	1204.9	23.39	1.507	0.947	189.0	421.2	1.025	1.902
-6	658.97	656.52	1197.2	25.01	1.516	0.960	192.0	421.9	1.036	1.898
-4	704.15	701.49	1189.4	26.72	1.524	0.975	195.0	422.6	1.048	1.894
-2	751.64	748.76	1181.4	28.53	1.533	0.990	198.1	423.2	1.059	1.890
0	801.52	798.41	1173.4	30.44	1.543	1.005	201.2	423.8	1.070	1.886
2	853.87	850.52	1165.3	32.46	1.552	1.022	204.3	424.4	1.081	1.882
4	908.77	905.16	1157.0	34.59	1.563	1.039	207.4	424.9	1.092	1.878
6	966.29	962.42	1148.6	36.83	1.573	1.057	210.5	425.5	1.103	1.874
8	1026.5	1022.4	1140.0	39.21	1.584	1.076	213.7	425.9	1.114	1.870
10	1089.5	1085.1	1131.3	41.71	1.596	1.096	216.8	426.4	1.125	1.866
12	1155.4	1150.7	1122.5	44.35	1.608	1.117	220.0	426.8	1.136	1.862
14	1224.3	1219.2	1113.5	47.14	1.621	1.139	223.2	427.2	1.147	1.859
16	1296.2	1290.8	1104.4	50.09	1.635	1.163	226.5	427.5	1.158	1.855
18	1371.2	1365.5	1095.1	53.20	1.650	1.188	229.7	427.8	1.169	1.851
20	1449.4	1443.4	1085.6	56.48	1.666	1.215	233.0	428.1	1.180	1.847
22	1530.9	1524.6	1075.9	59.96	1.683	1.243	236.4	428.3	1.191	1.843
24	1615.8	1609.2	1066.0	63.63	1.701	1.273	239.7	428.4	1.202	1.839
26	1704.2	1697.2	1055.9	67.51	1.721	1.306	243.1	428.6	1.214	1.834
28	1796.2	1788.9	1045.5	71.62	1.743	1.341	246.5	428.6	1.225	1.830
30	1891.9	1884.2	1034.9	75.97	1.767	1.379	249.9	428.6	1.236	1.826
32	1991.3	1983.2	1024.1	80.58	1.793	1.420	253.4	428.6	1.247	1.822
34	2094.5	2086.2	1012.9	85.48	1.822	1.465	256.9	428.4	1.258	1.817
36	2201.7	2193.1	1001.4	90.68	1.855	1.514	260.5	428.3	1.269	1.813
38	2313.0	2304.0	989.5	96.22	1.891	1.569	264.1	428.0	1.281	1.808
40	2428.4	2419.2	977.3	102.1	1.932	1.629	267.8	427.7	1.292	1.803
42	2548.1	2538.6	964.6	108.4	1.979	1.696	271.5	427.2	1.303	1.798
44	2672.2	2662.4	951.4	115.2	2.033	1.771	275.3	426.7	1.315	1.793
46	2800.7	2790.7	937.7	122.4	2.095	1.857	279.2	426.1	1.327	1.788
48	2933.7	2923.6	923.3	130.2	2.168	1.955	283.2	425.4	1.339	1.782
50	3071.5	3061.2	908.2	138.6	2.256	2.069	287.3	424.5	1.351	1.776
52	3214.0	3203.6	892.2	147.7	2.362	2.203	291.5	423.5	1.363	1.770
54	3361.4	3351.0	875.1	157.6	2.493	2.363	295.8	422.4	1.376	1.764
56	3513.8	3503.5	856.8	168.4	2.661	2.557	300.3	421.0	1.389	1.757
58	3671.3	3661.2	836.9	180.4	2.883	2.799	305.0	419.4	1.403	1.749
60	3834.1	3824.2	814.9	193.7	3.191	3.106	310.0	417.6	1.417	1.741
62	4002.1	3992.7	790.1	208.6	3.650	3.511	315.3	415.5	1.433	1.732
64	4175.7	4166.8	761.0	225.6	4.415	4.064	321.2	413.0	1.450	1.722

1.2 Service Tools

R-410A is used under higher working pressure, compared to previous refrigerants (R-22,R-407C). Furthermore, the refrigerating machine oil has been changed from Suniso oil to Ether oil, and if oil mixing is occurred, sludge results in the refrigerants and causes other problems. Therefore, gauge manifolds and charge hoses that are used with a previous refrigerant (R-22,R-407C) can not be used for products that use new refrigerants.

Be sure to use dedicated tools and devices.

■ Tool compatibility

Tool	Compatibility			Reasons for change
	HFC		HCFC	
	R-410A	R-407C	R-22	
Gauge manifold Charge hose	×			<ul style="list-style-type: none"> Do not use the same tools for R-22 and R-410A. Thread specification differs for R-410A and R-407C.
Gas detector	○		×	<ul style="list-style-type: none"> The same tool can be used for HFCs.
Vacuum pump (pump with reverse flow preventive function)	○			<ul style="list-style-type: none"> To use existing pump for HFCs, vacuum pump adaptor must be installed.
Weighting instrument	○			
Flaring tool (Clutch type)	○			<ul style="list-style-type: none"> For R-410A, flare gauge is necessary.
Torque wrench	○			<ul style="list-style-type: none"> Torque-up for 1/2 and 5/8
Pipe cutter	○			
Pipe expander	○			
Pipe bender	○			
Pipe assembling oil	×			<ul style="list-style-type: none"> Due to refrigerating machine oil change. (No Suniso oil can be used.)
Refrigerant recovery device	Check your recovery device.			
Refrigerant piping	See the chart below.			<ul style="list-style-type: none"> Only $\phi 19.1$ is changed to 1/2H material while the previous material is "O".

As for the charge mouthpiece and packing, 1/2UNF20 is necessary for mouthpiece size of charge hose.

■ Copper tube material and thickness

Pipe size [mm]	R-407C		R-410A	
	Material	Thickness [mm]	Material	Thickness [mm]
$\phi 6.4$	O	0.8	O	0.8
$\phi 9.5$	O	0.8	O	0.8
$\phi 12.7$	O	0.8	O	0.8
$\phi 15.9$	O	1.0	O	1.0
$\phi 19.1$	O	1.0	1/2H	1.0
$\phi 22.2$	1/2H	1.0	1/2H	1.0
$\phi 25.4$	1/2H	1.0	1/2H	1.0
$\phi 28.6$	1/2H	1.0	1/2H	1.0
$\phi 31.8$	1/2H	1.2	1/2H	1.1
$\phi 38.1$	1/2H	1.4	1/2H	1.4
$\phi 44.5$	1/2H	1.6	1/2H	1.6

* O: Soft (Annealed)
H: Hard (Drawn)

1. Flaring tool



■ Specifications

- Dimension A

Unit:mm

Nominal size	Tube O.D. Do	A ⁺⁰ _{-0.4}	
		Class-2 (R-410A)	Class-1 (Conventional)
1/4	6.35	9.1	9.0
3/8	9.52	13.2	13.0
1/2	12.70	16.6	16.2
5/8	15.88	19.7	19.4
3/4	19.05	24.0	23.3

■ Differences

- Change of dimension A

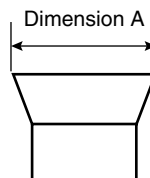

For class-1: R-407C
For class-2: R-410A

Conventional flaring tools can be used when the work process is changed.
(change of work process)

Previously, a pipe extension margin of 0 to 0.5mm was provided for flaring. For R-410A air conditioners, perform pipe flaring with a pipe extension margin of 1.0 to 1.5mm.

(For clutch type only)

Conventional tool with pipe extension margin adjustment can be used.

2. Torque wrench



■ Specifications

- Dimension B

Unit:mm

Nominal size	Class-1	Class-2	Previous
1/2	24	26	24
5/8	27	29	27

No change in tightening torque
 No change in pipes of other sizes

■ Differences

- Change of dimension B
 Only 1/2", 5/8" are extended

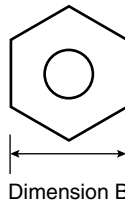

For class-1: R-407C
 For class-2: R-410A

3. Vacuum pump with check valve

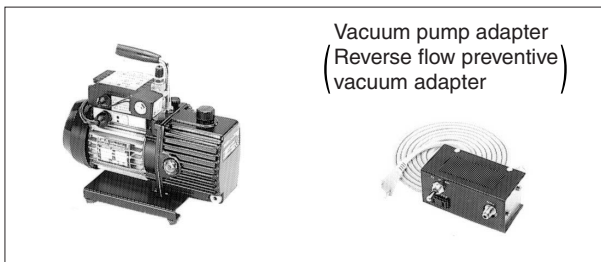

Vacuum pump adapter
 (Reverse flow preventive
 vacuum adapter)

■ Specifications

- Discharge speed
 50 l/min (50Hz)
 60 l/min (60Hz)
- Suction port UNF7/16-20(1/4 Flare)
 UNF1/2-20(5/16 Flare) with adapter
- Maximum degree of vacuum
 Select a vacuum pump which is able to keep the vacuum degree of the system in excess of -14.6 psi (5 torr or 5000 micron or - 755 mmHg).

■ Differences

- Equipped with function to prevent reverse oil flow
- Previous vacuum pump can be used by installing adapter.

4. Leak tester



■ Specifications

- Hydrogen detecting type, etc.
- Applicable refrigerants
R-410A, R-407C, R-404A, R-507A, R-134a, etc.

■ Differences

- Previous testers detected chlorine. Since HFCs do not contain chlorine, new tester detects hydrogen.

5. Refrigerant oil



■ Specifications

- Contains synthetic oil, therefore it can be used for piping work of every refrigerant cycle.
- Offers high rust resistance and stability over long period of time.

■ Differences

- Can be used for R-410A and R-22 units.

6. Gauge manifold for R-410A



- Specifications
 - High pressure gauge
15 to 770 psi (-76 cmHg to 53 kg/cm²)
 - Low pressure gauge
15 to 550 psi (-76 cmHg to 38 kg/cm²)
 - 1/4" → 5/16" (2min → 2.5min)
 - No oil is used in pressure test of gauges.
→ For prevention of contamination
 - Temperature scale indicates the relationship between pressure and temperature in gas saturated state.
- Differences
 - Change in pressure
 - Change in service port diameter

7. Charge hose for R-410A

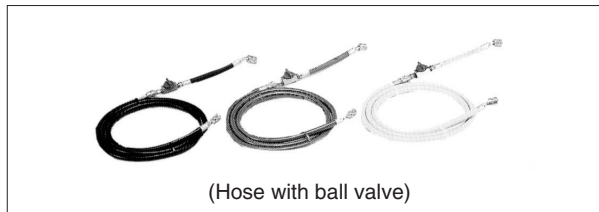

- Specifications
 - Working pressure 737 psi (51.8 kg/cm²)
 - Rupture pressure 3685 psi (259 kg/cm²)
 - Available with and without hand-operate valve that prevents refrigerant from outflow.
- Differences
 - Pressure proof hose
 - Change in service port diameter
 - Use of nylon coated material for HFC resistance

8. Weigher for refrigerant charge



- Specifications
 - High accuracy
 - TA101A (for 10-kg cylinder) = $\pm 2\text{g}$
 - TA101B (for 20-kg cylinder) = $\pm 5\text{g}$
 - Equipped with pressure-resistant sight glass to check liquid refrigerant charging.
 - A manifold with separate ports for HFCs and previous refrigerants is equipped as standard accessories.
- Differences
 - Measurement is based on weight to prevent change of mixing ratio during charging.

Regarding purchasing of service tools, please contact following address.
Daikin U.S. Corporation (Dallas Office)
1645 Wallace Dr, Ste 110 Carrollton, TX 75006
"Tel: 1-972-245-1510 FAX: 1-972-245-1038"

Index

A

A0	94
A1	95
A3	96
A6	98
A7	99
A9	101
abnormal discharge pipe temperature	118
about refrigerant R-410A	184
actuation of high pressure switch	110
actuation of low pressure switch	111
address duplication of centralized controller	147
address duplication, improper setting	156, 169
AF	103
AJ	104
applicable range of field setting	55
auto restart after power failure reset	56

C

C4	105
C5	106
C9	107
centralized control group no. setting	58
check No. 1	170
check No. 2	171
check operation	47, 77
check operation not executed	139
check work prior to turn power supply on	46
CJ	108
compressor motor lock	113
compressor PI control	22
contents of control modes	60
cool/heat mode switching	68
cooling operation fan control	24

D

defrosting operation	28
demand operation	70
discharge pipe protection control	35
display "under centralized control" blinks (repeats double blink)	162
display "under centralized control" blinks (repeats single blink)	159
drain level above limit	103
drain pump control	38

E

E1	109
E3	110
E4	111
E5	113

E7	114
E9	116
electrical and functional parts	
indoor units	13
outdoor units	12
electronic expansion valve PI control	23
error of external protection device	94

F

F3	118
fan motor (M1F) lock, overload	98
fan speed changeover when thermostat is off	56
faulty combination of inverter and fan driver	135
field setting	51
field setting from outdoor unit	62
filter sign setting	56
freeze prevention	43
functional parts layout	18

H

H9	119
heating operation prohibition	37
high pressure protection control	33

I

improper combination of indoor units and outdoor units, indoor units and remote controller	146
improper combination of optional controllers for centralized control	154, 167
inverter compressor abnormal	128
inverter current abnormal	129
inverter protection control	36
inverter start up error	131

J

J3	120
J5	121
J6	122
J9	123
JA	124
JC	126

L

L4	127
L5	128
L8	129
L9	131
LC	132
louver control for preventing ceiling dirt	40
low noise operation	70

low pressure drop due to refrigerant shortage or
 electronic expansion valve failure 136
 low pressure protection control..... 34

M

M1 152, 165
 M8..... 153, 166
 MA 154, 167
 malfunction code indication by
 outdoor unit PCB 92
 malfunction of capacity determination device 104
 malfunction of discharge pipe thermistor (R3T).... 120
 malfunction of drain level control system (S1L)..... 96
 malfunction of high pressure sensor..... 124
 malfunction of inverter radiating fin
 temperature rise 127
 malfunction of inverter radiating fin
 temperature rise sensor 134
 malfunction of low pressure sensor 126
 malfunction of moving part of electronic expansion
 valve 116
 malfunction of moving part of electronic expansion
 valve (20E) 101
 malfunction of outdoor unit fan motor 114
 malfunction of subcooling heat exchanger gas pipe
 thermistor (R5T) 123
 malfunction of swing flap motor (MA) 99
 malfunction of system, refrigerant system address
 undefined..... 151
 malfunction of thermistor (R1T) for outdoor air.... 119
 malfunction of thermistor (R1T) for suction air 107
 malfunction of thermistor (R2T) for
 heat exchanger..... 105
 malfunction of thermistor (R2T) for suction pipe... 121
 malfunction of thermistor (R3T) for gas pipes 106
 malfunction of thermistor (R4T) for
 outdoor unit heat exchanger deicer..... 122
 malfunction of thermostat sensor in
 remote controller 108
 malfunction of transmission between centralized
 controller and indoor unit..... 148, 163
 malfunction of transmission between indoor units and
 outdoor units in the same system..... 144
 malfunction of transmission between indoor units and
 outdoor units..... 140
 malfunction of transmission between inverter and
 control pc board..... 132
 malfunction of transmission between main and sub
 remote controllers..... 143
 malfunction of transmission between optional
 controllers for centralized control 153, 166
 malfunction of transmission between remote
 controller and indoor unit..... 142
 MC 156, 169

N

normal operation..... 21

O

oil return operation..... 26
 operation lamp blinks..... 157
 operation mode..... 20
 operation when power is turned on..... 49
 outdoor unit PC board layout..... 50

P

P4 134
 PC board defect..... 95, 109, 152, 165
 piping diagrams 174
 PJ..... 135
 power supply insufficient or
 instantaneous failure 137
 precautions for new refrigerant (R-410A) 184
 pressure equalization prior to startup 32
 pressure sensor..... 181
 protection control 33
 pump-down residual operation 29

R

refrigerant circuit..... 16
 refrigerant recovery mode..... 76
 restart standby..... 30

S

service tools..... 186
 setting by dip switches..... 62
 setting by pushbutton switches..... 63
 setting contents and code No. – VRV unit..... 54
 startup control 25
 stopping operation 31
 swing flaps 44
 system is not set yet 150

T

test operation
 procedure and outline 46
 thermistor resistance /
 temperature characteristics 179
 thermostat sensor in remote controller 41

U

U0 136
 U2 137
 U3 139
 U4 140
 U5 142
 U8 143
 U9 144
 UA..... 146
 UC..... 147
 UE..... 148, 163
 UF..... 150
 UH..... 151

V

vacuuming mode 76

W

wiring diagrams 176

Drawings & Flow Charts

A

abnormal discharge pipe temperature	118
actuation of high pressure switch	110
actuation of low pressure switch.....	111
address duplication of centralized controller	147
address duplication, improper setting.....	156, 169

B

BRC7C Type	59
BRC7E Type.....	59

C

centralized control group No. setting	
BRC1C Type	58
group No. setting example	59
charge hose for R-410A	190
check No. 1.....	170
check No. 2.....	171
check operation	47
check operation not executed.....	139
check work prior to turn power supply on	46
compressor motor lock	113
contents of control modes	
how to select operation mode	61
cooling operation fan control	24

D

discharge pipe protection control.....	35
display “under centralized control” blinks (repeats double blink).....	162
display “under centralized control” blinks (repeats single blink)	159
display of sensor and address data.....	88
drain level above limit.....	103
drain pump control	
when the float switch is tripped and “AF” is displayed on the remote controller	39
when the float switch is tripped while the cooling thermostat is off.....	38
when the float switch is tripped during heating operation	39
when the float switch is tripped while the cooling thermostat is on.....	38

E

error of external protection device	94
---	----

F

fan motor (M1F) lock, overload.....	98
faulty combination of inverter and fan driver.....	135

field setting from outdoor unit

mode changing procedure	63
flaring tool	187
forced fan on.....	88
freeze prevention.....	43
functional parts layout.....	18

G

gauge manifold for R-410A.....	190
--------------------------------	-----

H

high pressure protection control	33
how to enter the service mode.....	87

I

improper combination of indoor units and outdoor units, indoor units and remote controller	146
improper combination of optional controllers for centralized control	154, 167
individual setting	88
inverter compressor abnormal.....	128
inverter current abnormal.....	129
inverter protection control	36
inverter start up error	131

L

leak tester	189
louver control for preventing ceiling dirt.....	40
low pressure drop due to refrigerant shortage or electronic expansion valve failure.....	136
low pressure protection control.....	34

M

malfunction hysteresis display	88
malfunction of capacity determination device	104
malfunction of discharge pipe thermistor (R3T)....	120
malfunction of drain level control system (S1L).....	96
malfunction of high pressure sensor.....	124
malfunction of inverter radiating fin	
temperature rise	127
malfunction of inverter radiating fin temperature rise sensor.....	134
malfunction of low pressure sensor	126
malfunction of moving part of electronic expansion valve	116
malfunction of moving part of electronic expansion valve (20E)	101
malfunction of outdoor unit fan motor	114
malfunction of subcooling heat exchanger gas pipe thermistor (R5T)	123
malfunction of swing flap motor (MA)	99

malfunction of system, refrigerant system address undefined.....	151	system is not set yet	150
malfunction of thermistor (R1T) for outdoor air.....	119	T	
malfunction of thermistor (R1T) for suction air	107	the inspection / test button.....	82
malfunction of thermistor (R2T) for heat exchanger.....	105	thermostat sensor in remote controller	
malfunction of thermistor (R2T) for suction pipe...	121	cooling.....	41
malfunction of thermistor (R3T) for gas pipes	106	heating	42
malfunction of thermistor (R4T) for outdoor unit heat exchanger deicer.....	122	torque wrench.....	188
malfunction of thermostat sensor in remote controller	108	turn power on.....	46
malfunction of transmission between centralized controller and indoor unit.....	148, 163	U	
malfunction of transmission between indoor units and outdoor units in the same system.....	144	unit No. transfer	88
malfunction of transmission between indoor units and outdoor units.....	140	W	
malfunction of transmission between inverter and control pc board.....	132	weigher for refrigerant charge.....	191
malfunction of transmission between main and sub remote controllers.....	143	wired remote controller	51
malfunction of transmission between optional controllers for centralized control	153, 166	wireless remote controller - indoor unit.....	52
malfunction of transmission between remote controller and indoor unit.....	142	wiring diagrams for reference	
O		indoor unit	177
operation lamp blinks.....	157	outdoor unit	176
operation mode.....	20		
operation of the remote controller's inspection / test operation button	86		
outdoor unit pc board layout.....	50		
P			
pc board defect.....	95, 109, 152, 165		
piping diagrams			
indoor unit	175		
outdoor unit	174		
power supply insufficient or instantaneous failure	137		
pressure sensor.....	181		
R			
refrigerant circuit.....	16		
refrigerant oil.....	189		
S			
self-diagnosis by wired remote controller	83		
set cool / heat separately for each outdoor system by indoor unit remote controller.....	69		
setting of air flow direction adjustment range	57		
setting of demand operation			
image of operation	73		
setting of low noise operation			
image of operation	71		
simplified remote controller.....	53		

Warning



- Ask a qualified installer or contractor to install this product. Do not try to install the product yourself. Improper installation can result in water or refrigerant leakage, electrical shock, fire or explosion.
- Use only those parts and accessories supplied or specified by Daikin. Ask a qualified installer or contractor to install those parts and accessories. Use of unauthorized parts and accessories or improper installation of parts and accessories can result in water or refrigerant leakage, electrical shock, fire or explosion.
- Read the User's Manual carefully before using this product. The User's Manual provides important safety instructions and warnings. Be sure to follow these instructions and warnings.

For any inquiries, contact your local distributor.



© 2004 Daikin Industries, Limited.

Daikin®, Daikin AC™, Absolute Comfort™, VRV® and REFNET™ are trademarks pending or registered trademarks of Daikin Industries, Limited. All rights reserved. LowWorks® and LON® are registered trademarks of Echelon Corporation. BACnet® is a Data Communication Protocol for Building Automation and Control Networks, developed under the auspices of the American Society of Heating, Refrigerating and Air-Conditioning Engineers (ASHRAE).



The air conditioners manufactured by Daikin Industries have received **ISO 9001** certification for quality assurance.

Certificate Number. **JMI-0107**
JQA-0495
JQA-1452



All Daikin Industries locations and subsidiaries in Japan have received environmental management system standard **ISO 14001** certification.

Daikin Industries, Ltd.
Domestic Group
Certificate Number. EC99J2044

About ISO 14001

ISO 14001 is the standard defined by the International Organization for Standardization (ISO) relating to environmental management systems. Our group has been acknowledged by an internationally accredited compliance organisation as having an appropriate programme of environmental protection procedures and activities to meet the requirements of ISO 14001.

Dealer

DAIKIN U.S. CORPORATION

1645 Wallace Drive, Suite 110
Carrollton, TX75006
info@daikinac.com
www.daikinac.com

©All rights reserved

•The specifications, designs, and information in this brochure are subject to change without notice.