

# Condensing **NAVIENT**

Navigating Energy and Environment

## Owner's Operation Manual

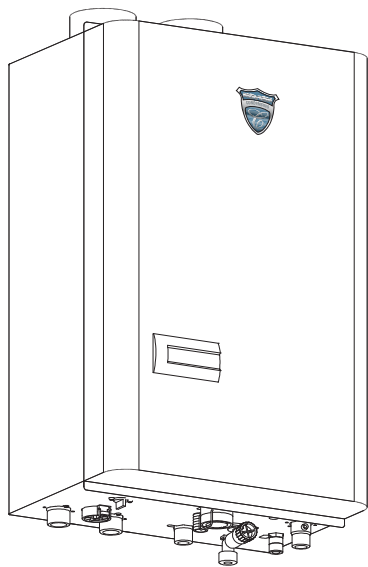

For potable water heating and space heating



MODEL

**CH-180**

**CH-210**

**CH-240**

Keep this manual near the Navien Combination Water Heater for future reference whenever maintenance or service is required.

### **⚠ WARNING**

If not followed this operation manual exactly, a fire or explosion may result causing property damage, personal injury or death.

- Do not store or use gasoline or other flammable vapors and liquids in the vicinity of this or any other appliance.
- **WHAT TO DO IF YOU SMELL GAS**
  - Do not try to light any appliance.
  - Do not touch any electrical switch: do not use any phone in your building.
  - Immediately call your gas supplier from a neighbor's phone. Follow the gas supplier's instructions.
  - If you cannot reach your gas supplier, call the fire department.
- Installation and service must be performed by a qualified installer, service agency or the gas supplier.

°7-CREATOR  
**KD NAVIENT**

Navien Gas Combination Water Heater  
**Owner's Operation Manual**





# Operation manual - contents

<b>Safety Instructions</b>	Safety Related Symbols .....	3
	Warning - Safety Precautions .....	4
	Danger .....	5
	Danger - What to do If you smell gas .....	6
	Danger - Compromised Venting System .....	6
	Danger - Hot Water Temperature Setting .....	7
<b>Personal Safety</b>	Equipment Protection and Personal Safety .....	8
<b>Warranty</b>	Navien Warranty .....	10
	Navien America, Inc. Limited Warranty .....	11
<b>Operating Instructions</b>	General Parts .....	12
	Remote Controller .....	13
	LCD Display Icons .....	14
	Remote Controller ON/OFF .....	15
	Setting the Clock .....	15
	Hot Water Temp. Setting .....	16
	Pre-Heating setting .....	17
	Room Temp. Setting (Options) .....	18
	Return Temp. Setting (Options) .....	19
	Supply Temp. Setting (Options) .....	20
	K-Factor (Options) .....	20
	Program (24th Timer) .....	21
	Stand By .....	22
	Lock .....	22
	Heat Capacity control .....	23
	Capacity Control of the Whole .....	24
	Setting up the way of control of hot water .....	25
	Well Pump Setting .....	26
	Supply Water Press. Setting .....	27
	Functon ot set the number of initial activating water heaters when cascade is used .....	28
	Functon to set pump activating water heaters when cascade is used .....	29
	Combination Water Heater : Heating .....	30
	Combination Water Heater : DHW .....	31
<b>Maintenance</b>	Cleaning the Combination Water Heater .....	32
	Draining the Combination Water Heater .....	33
	Auto Feeder of the Combination water Heater .....	34
	Cleaning the Inlet Water Filter .....	35
	Cleaning the Strainer .....	36
	Cleaning the Air-Intake Filter .....	37
	Optional Outdoor Temp. Sensor .....	38
	Freeze Protection .....	39
<b>Troubleshooting &amp; Error Code Guide</b>	FND Display .....	40
	Basic Troubleshooting (FAQ) .....	40
	Error Code Guide .....	42
<b>Service</b>	Service .....	47

# Safety Instructions

Safety-related information and instructions have been provided in this manual and on the Navien combination water heater to warn any person(s) of potential hazards. Read and follow all safety information and instructions throughout this manual. It is very important to understand the safety instructions before installing, operating or servicing Navien combination water heaters.

## Safety Related Symbols

	<p>This is safety alert symbol. It is used to alert you to potential personal injury hazards. Obey all safety messages that follow this symbol to avoid possible injury or death.</p>
 <b>DANGER</b>	<p><b>DANGER</b> indicates an imminently hazardous situation which, if not avoided, could result in injury or death.</p>
 <b>WARNING</b>	<p><b>WARNING</b> indicates a potential hazardous situation which, if not avoided, could result in injury or death.</p>
 <b>CAUTION</b>	<p><b>CAUTION</b> indicates an imminently hazardous situation which, if not avoided, may result in minor or moderate injury.</p>
<b>CAUTION</b>	<p><b>CAUTION</b> used without the safety alert symbol indicates a potential hazardous situation which, if not avoided, could result in property damage.</p>

All safety information will refer to a potential hazard. Follow the instructions in this manual exactly to avoid the risk of injury.

# Safety Instructions



## WARNING Safety Precautions

- Read and understand this safety information before installing, operating or servicing this Navien combination water heater.
- This manual must remain with the Navien combination water heater.
- Have your installer show you the location of the gas shut-off valve and show you how to close the valve. Close the manual shut-off valve if the Navien combination water heater ever becomes subjected to overheating, fire, flood, physical damage or any other such damaging condition. And, DO NOT operate the water heater again until it has been checked by qualified personnel.
- DO NOT turn on combination water heater unless water and gas supplies are fully opened.
- DO NOT turn on combination water heater if cold water supply shut-off valve is closed.
- DO NOT use this Navien combination water heater for other than its intended purpose as described in this manual.
- DO NOT attempt to repair or replace any part of your combination water heater unless it is specifically recommended in this manual. All other servicing should be referred to an Authorized Service Technician.
- Make certain power to combination water heater is turned "OFF" before attempting to make any repairs to your Navien water heater.
- Label all wires prior to disconnecting and servicing controls. Wiring errors can cause improper and/or dangerous operation. Verify proper operation after servicing.
- Improper adjustment, alteration, service or maintenance can cause property damage, personal injury or death.
- To prevent scalding always check the temperature of the hot water before showering, bathing etc.
- DO NOT attempt to change the temperature setting while someone is using the combination water heater.
- DO NOT use parts other than those specified for this equipment.
- DO NOT operate the water heater if you feel something is wrong with the unit.
- DO NOT allow children to operate or otherwise handle the the unit.



## WARNING

**This product must be installed and serviced by a licensed plumber, a licensed gas fitter, or a professional service technician. Improper installation and/or operation by an unqualified person will void the warranty.**

# Safety Instructions

 **DANGER**



 Vapors from flammable liquids will explode and catch fire causing death or severe burns. Do not use or store flammable products such as gasoline, solvents or adhesives in the same room or area near the water heater.

Keep flammable products:

1. far away from heater;
2. in approved containers;
3. tightly closed; and
4. out of children's reach.

Water heater has a main burner flame:

1. which can come on at any time; and
2. may ignite flammable vapors.

Vapors:

1. cannot be seen;
2. are heavier than air;
3. go a long way on the floor; and
4. can be carried from other rooms to the main burner flame by air currents.

Read and follow combination water heater warnings and instructions. If owners manual is missing, contact the retailer or manufacturer.

- DO NOT place flammable liquids such as oils or gasoline, etc. near the combination water heater.
- DO NOT place combustibles such as newspapers and laundry etc. near the combination water heater or venting system.
- DO NOT place or use hair spray, spray paint or any other type of spray can near the combination water heater or the venting system (including the vent terminator).
- DO NOT place anything in or around the vent terminals that could obstruct the air flow in and out of the combination water heater such as a clothes line.
- DO NOT operate the combination water heater when the front cover is opened. Operating the combination water heater under such condition may cause fire or carbon monoxide(CO) poisoning, which may result in property damage, personal injury or even death.

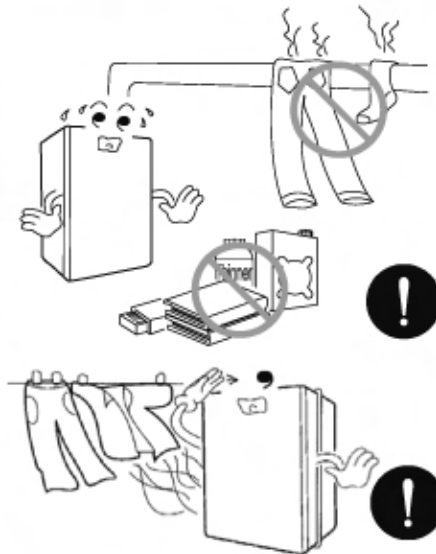

## Safety Instructions



### **DANGER**

#### **WHAT TO DO IF YOU SMELL GAS**

If you do not follow these instructions exactly, a fire or an explosion may result causing property damage, personal injury or loss of life.

- ❑ **DO NOT OPERATE THE COMBINATION WATER HEATER. DO NOT OPERATE ANY FAUCET. Smell all around the combination water heater area for gas. Be sure to smell near the floor because as some gas is heavier than air and will settle near the floor.**
  - ▶ DO NOT try to light any appliance.
  - ▶ DO NOT touch any electric switch.
  - ▶ DO NOT use any phone in your building.
  - ▶ Immediately contact your Gas Supplier from a neighbor's phone.
  - ▶ Follow the Gas Supplier's instructions.
  - ▶ If you cannot reach your Gas Supplier, call 911 for police and/or the fire department.
  - ▶ DO NOT return to your home until authorized by your gas supplier or the fire department.



### **DANGER**

#### **COMPROMISED VENTING SYSTEM**

- ❑ Failure to follow the Venting Section of the installation manual may result in the unsafe operation of this combination water heater. To avoid the risk of fire, explosion or asphyxiation from carbon monoxide, never operate the water heater unless it is properly vented to outside and has an adequate air supply for proper operation;
- ❑ Be sure to inspect the vent terminator and the air intake pipe annually to ensure safe operation of the combination water heater;
- ❑ Immediately turn off and do not use the combination water heater if any of the vent pipes, vent elbows and/or the air intake pipe are :
  - i. damaged in any way;
  - ii. have separated at a joint;
  - iii. are cracked or show evidence of corrosion, rusting or melting;



### **WARNING**

Improper venting may cause a build-up of carbon monoxide (CO). Breathing carbon monoxide can cause brain damage or death. Read and follow the above instructions carefully.

# Safety Instructions



## DANGER

### HOT WATER TEMPERATURE SETTING

- ❑ This Navien combination water heater is factory set at 120°F (49°C) for your safety and comfort. Increasing the set temperature increases the risk of accidental scalding. Consult the chart below before you decide to adjust the set temperature.

Water Temperature	Time in which a young child can suffer a full thickness (3rd degree) burn*
70°C (160°F)	Less than 1 second
60°C (140°F)	1 second
55°C (130°F)	10 seconds
49°C (120°F)	10 minutes
37°C (100°F)	Very low scald risk

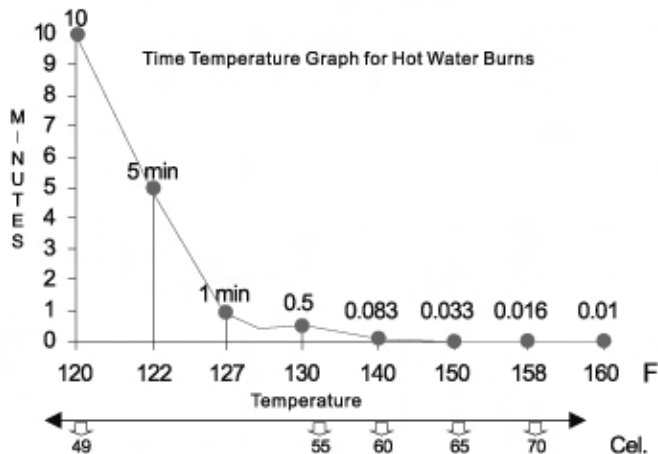

## DANGER



Water temperature over 125°F can cause severe burns instantly or death from scalds.

Children, disabled and elderly are at highest risk of being scalded.

See instruction manual before setting temperature at water heater.

Feel water before bathing or showering.

Temperature limiting valves are available, see manual.



## DANGER

- ❑ Households with small children, disabled or elderly persons may require 120°F (49°C) or lower temperature setting to prevent contact with "HOT" water.
- ❑ Water temperatures over 125°F can cause severe burns instantly or death from scalds. If the proposed combination water heater outlet temperature is above 125°F, a thermostatically controlled mixing valve or temperature limiting valve should be considered to reduce the risk of scalding. Contact a licensed plumber or the local plumbing authority for further information.

## Equipment Protection and Personal Safety

### 1. Ignition Failure

If the ignition fails, the gas supply is automatically cut off. An error code will appear as a flashing 2-digit code on the room thermostat. The error codes are discussed in the troubleshooting section of the operation manual.

### 2. Flame Detection

If the flame fails and/or the re-ignition attempt fails, the gas supply is automatically cut off. An error code will appear on the room thermostat. Refer to troubleshooting guide to further information.

### 3. Power Interruption

When the power is restored after a power failure, the combination water heater will automatically start and return to normal operation, manual reset is not required.

### 4. Excessive Air Pressure

Occasionally an excessive gust of wind may be forced into the flue pipe. The air-ratio control module will detect these strong back-drafts. To prevent any products of combustion from re-entering the building through the open flue, the gas supply will be automatically cut off. An error code will appear on the room. Refer to troubleshooting guide to further information.

### 5. Explosive Re-ignition Protection

Abrupt, noisy startups and backfires are prevented by "*soft ignition*" a trademark of our air-ratio control module.

### 6. Overheat Protection

Any overheating of the burners or heat exchanger will automatically shut down the supply of gas to the burners. An error code will appear on the room thermostat. Refer to troubleshooting guide to further information.

### 7. Low Water-Level Safety

The water level in the heat exchanger is continuously monitored to prevent the combination water heater from operating if there is no water or a restricted flow of water in the unit. The combination water heater will be automatically shut down and an error code will appear on the room thermostat. Refer to troubleshooting guide to further information.



**8. Automatic Water Fill**

Should the water level in the system fall too low, a sensor will automatically activate the re-fill circuit.

**9. Freeze Protection**

During the heating season, a sensor inside the combination water heater will automatically detect and initiate a safety heating cycle to prevent internal equipment damage from occurring freezing temperatures exist.

**Note !** – When there is no gas supply available, the circulation pump will automatically start up to guard the pipes from freezing.

**10. Gas Pressure Control**

To prevent damage from over pressure, each combination water heater is protected from occasional surges in gas pressure by a pressure regulator located in the gas valve.

**11. Short-Circuit Protection**

Any short-circuit occurring in the combination water heater's electrical circuit will immediately 'blow' the internal glass fuse(s) and automatically cut off the gas supply.

**12. Lightning Protection**

Each combination water heater is specially grounded internally and externally to protect against lightning strikes.

**13. Carbon Monoxide Protection**

The combination water heater is designed to maintain a safe air and gas ratio and combustion rate. This function is continuously monitored by the combination water heater's air-ratio control module.

**14. Thermostat Control Failure**

Should the thermostat fail to function properly, as a safeguard, the combination water heater's gas supply will be automatically shut down.

**15. Auto Fan Detection**

The rotation of the fan is automatically detected and controlled. Fan failure will stop the operation of the combination water heater.

**16. Boiling Prevention**

Excessive temperatures will automatically stop the combination water heater.

## Navien Warranty:

### GENERAL

Navien America, Inc. (Navien) warrants this Navien gas condensing combination water heater and its component parts to be free from defects in materials and workmanship, under normal use and service, for the Applicable Warranty Period. At its option, Navien will replace the defective component part(s), in accordance with the terms of this Limited Warranty, if it fails in normal use and service during the Applicable Warranty Period. The replacement component part(s) must be Navien Original factory component part(s). The replacement component part(s) will be warranted only for the remaining portion of the original component part's Applicable Warranty Period.

### APPLICABLE WARRANTY PERIODS

Period of Coverage	
Heat Exchanger	All other Parts and Components
CH Series	CH Series
<b>10 years</b>	<b>5 years</b>



Proof of purchase is required to obtain warranty service. You can show proof of purchase with dated sales receipt, by completing and mailing the enclosed warranty registration card within 30 days of purchasing the product or by registering online at [www.navienamerica.com](http://www.navienamerica.com)

### EFFECTIVE DATE

The Effective Date of warranty coverage (the beginning of the Applicable Warranty Periods) is the date of purchase of this combination water heater, if properly registered.

### HEAT EXCHANGER WARRANTY

The Applicable Warranty Period for a CH series Heat Exchanger failure installed in a Residential application is **Ten (10)** years from the Effective Date.

### PARTS WARRANTY (excluding heat exchanger)

The Applicable Warranty Period for a CH series Part(s) failure installed in a Residential application is **Five (5)** years from the Effective Date.

# Navien America, Inc. Limited Warranty

## LABOR ALLOWANCE:

The Applicable Period for this Labor Allowance for all Combination Water Heater models is One (1) year from the Effective Date. The payment and amount of any payment are subject to approval at Navien's sole discretion. The Labor Allowance will be paid based on Navien's Schedule of Labor Allowances.

## TRANSFERABILITY

This warranty is offered to the original and subsequent owners of the combination water heater but is limited to the original address registered with the warranty only. The warranty will be void if the combination water heater is relocated to any other location.

## WARRANTY EXCLUSIONS

This warranty does not cover the following conditions:

- Damages, malfunctions or failures resulting from failure to install the combination water heater in accordance with applicable building codes, ordinances or normal plumbing and electrical trade practices.
- Damages, malfunctions or failures resulting from improper installation or failure to operate and maintain the combination water heater in accordance with the manufacturer's instructions provided.
- Performance problems caused by improper sizing of the combination water heater or the gas supply line, the venting connection, combustion air openings, electric service voltage, wiring or fusing.
- Damages, malfunctions or the all failures caused by conversion from natural gas to LP gas or LP gas to natural gas or attempt to operate with a type of gas not specified for the combination water heater.
- Damages, malfunctions or failures caused by operating the combination water heater with any parts removed or with parts that have been modified, altered or unapproved for installation.
- Damages, malfunctions or failures caused by abuse, negligence, alteration, accident, fire, flood, freezing, lightning and other acts of God.
- Heat Exchanger failures caused by operating the combination water heater in a corrosive or contaminated atmosphere.
- Damages, malfunctions or failure caused by poor water quality, lime or mineral build-up or sediment build-up.
- Damages, malfunctions or failures caused by operating the unit at water temperatures outside the factory calibrated temperature limits and/or exceeding the maximum setting of the high limit control.
- Heat Exchanger failures caused by operating the combination water heater when it is not supplied with potable water at all times.
- Damages, malfunctions or failures caused by subjecting the heat exchanger to pressures or firing rates greater or lesser than those shown on the rating plate.
- Units installed outside of the fifty states (and the District of Columbia) of the United States of America and outside of Canada.
- Rating plate has been removed by an unauthorized person. A water combination heater should not be operated if the rating plate has been removed.
- Damage due to freezing.



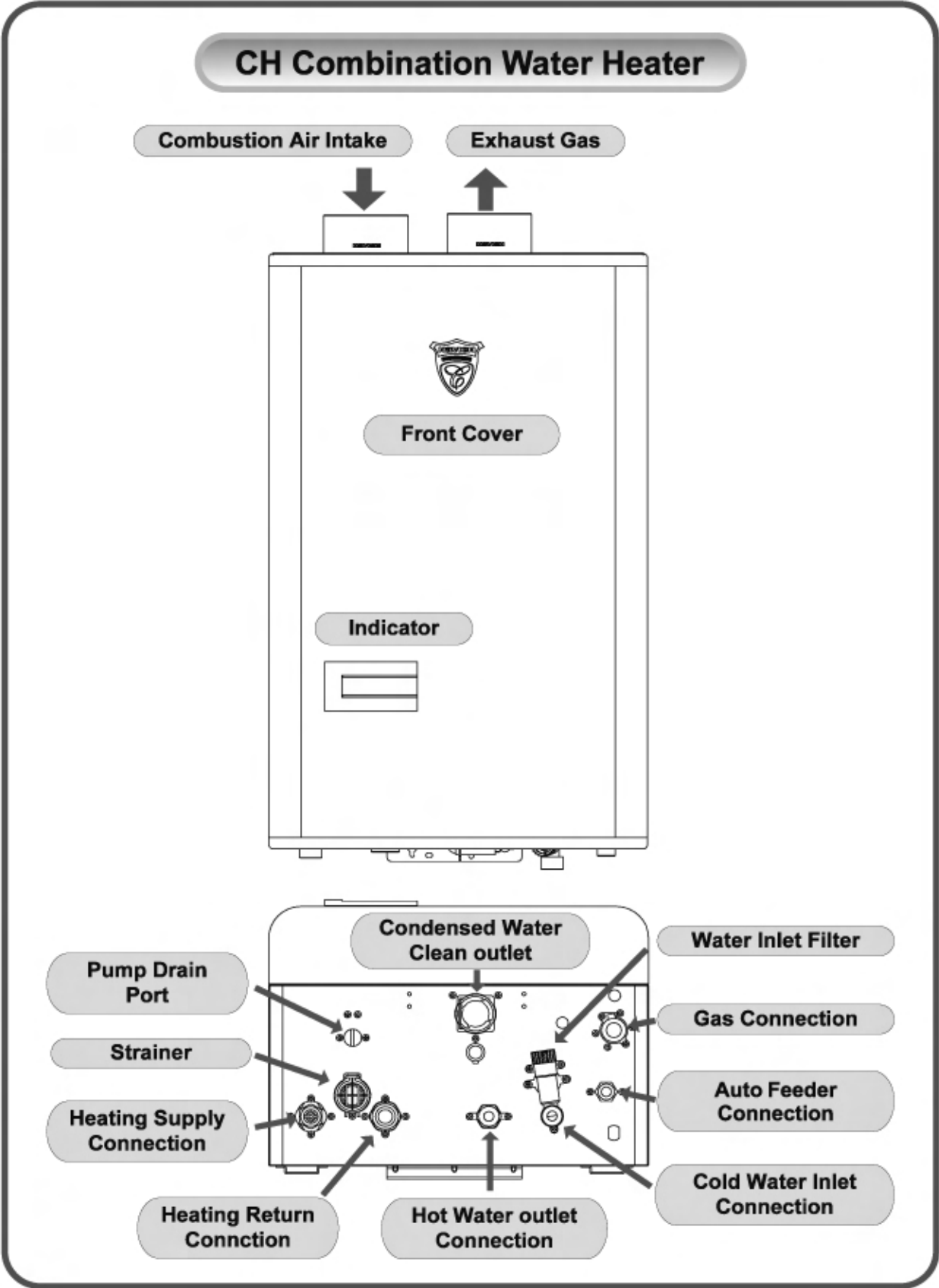



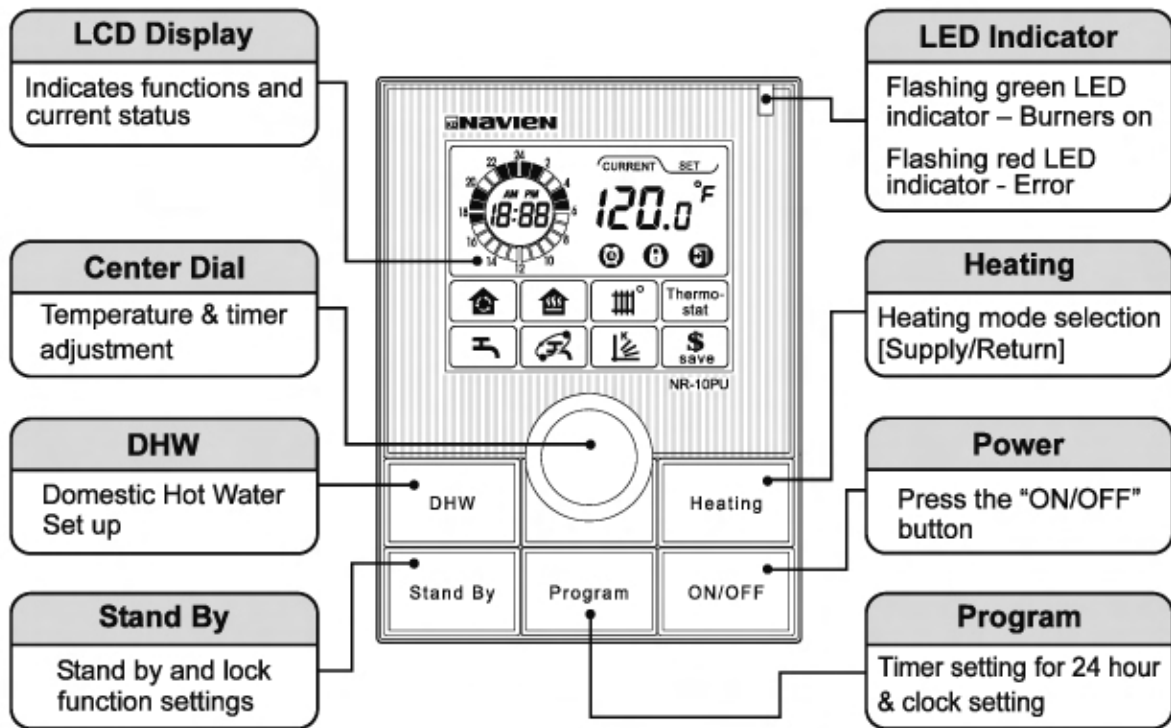







# General Parts

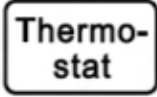

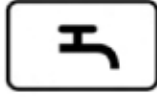
# Remote Controller

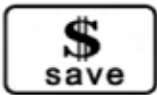

## LCD Display Icons

	Timer display for 24hour clock		Room temperature set
	Clock		Space heating Return water temperature
	Temperature		Space heating Supply temperature
	24 Hour heating timer indicator		THERMOSTAT controlled heating
	Lock		Hot water " In use "
	Stand By		Hot water pre-heating
	Current temperature		K Factor
	Setting temperature		Energy saving mode

## ■ Remote Controller ON/OFF

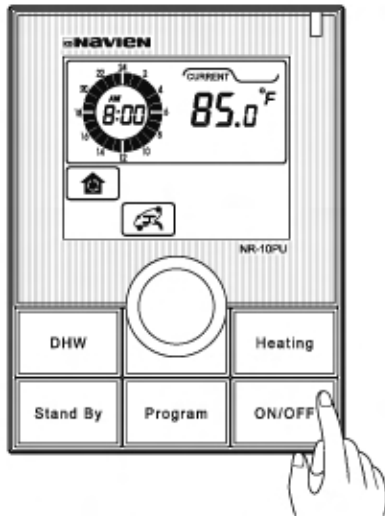

Press the ON/OFF button to turn the LCD on and off.

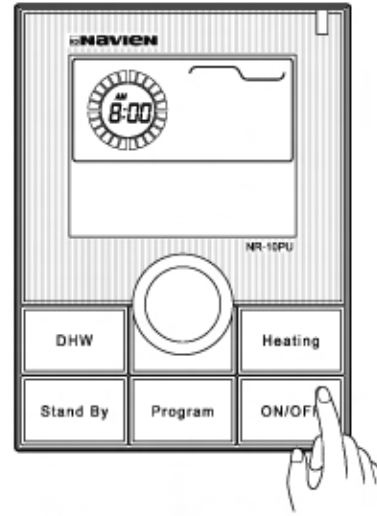

When the ON/OFF button is pressed, the LCD display switches to only a clock display. In this status any heating mode & domestic hot water are disabled.

## ■ Setting the Clock

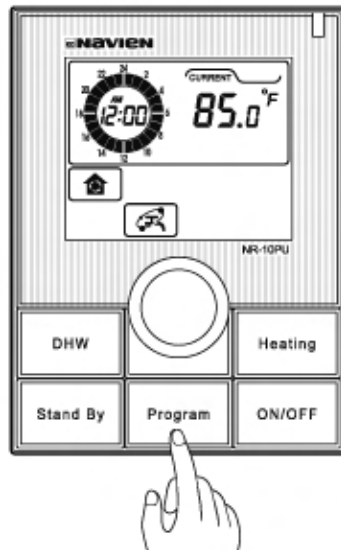

Press and hold "Program" button for 3 seconds, the "minutes" blink on the timer.

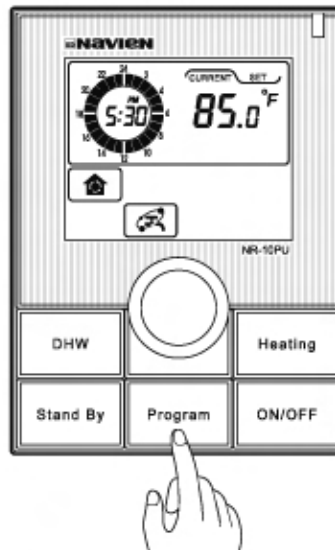

Use the center dial to move around the "minutes" and tap the "Program" button and the "hour" will blink. Use the center button to adjust the hour. Tap the "Program" button to adjust the AM/PM setting. Leave alone and the display will automatically set.

## ■ Hot Water Temperature Setting

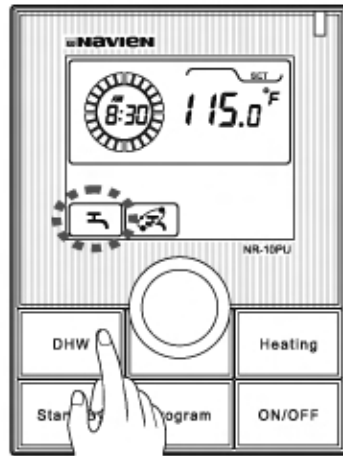

If the DHW button is pressed, 'hot water' icon flickers and temperature of hot water (86~120°F) is displayed. If temperature over 120°F is needed, DHW and Heating button shall be pressed simultaneously. Then user can adjust set temperature of hot water up to 140°F



When the 'hot water' icon flickers turn the dial to set desire hot water temperature. After a few seconds, the desire temperature is saved and get back to the previous function.



## ■ Pre-heating Setting

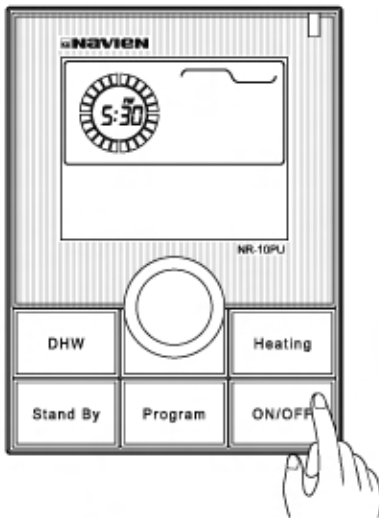

Please turn off the power of R/C pressing ON/OFF button.

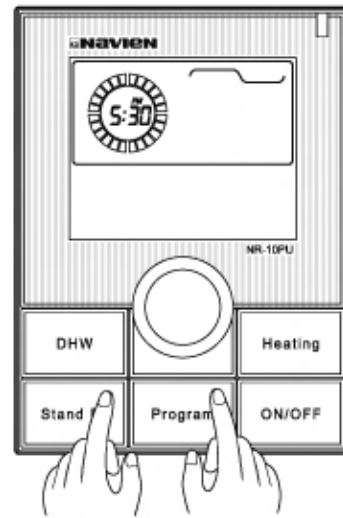

Press and hold the "Stand By" and "Program" buttons simultaneously for 3 seconds.

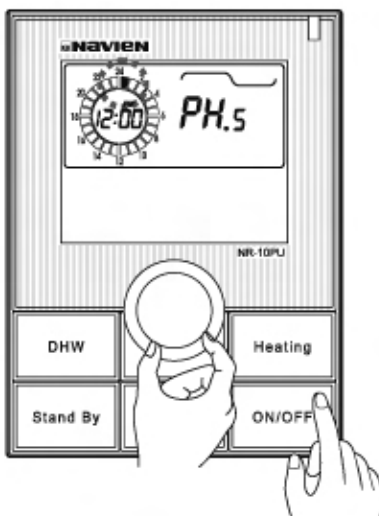

When the "Clock" is flashing with the cursor "■" use the center dial to move the cursor around. Tap the "Heating" button to enable (solid) or disable (blank) the specified time frame.

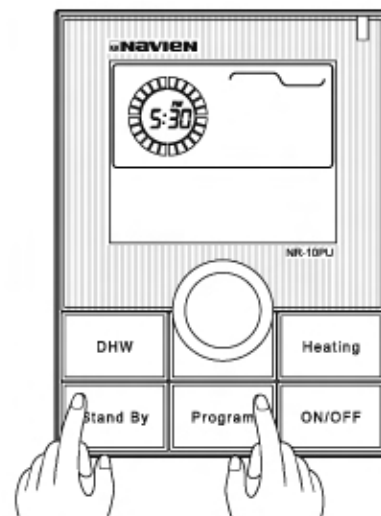

After setting the timer, press and hold "Stand By" and "Program" buttons simultaneously for 3 seconds. Preheating function is only available during R/C is on.

■ Room Temperature Setting (Options)

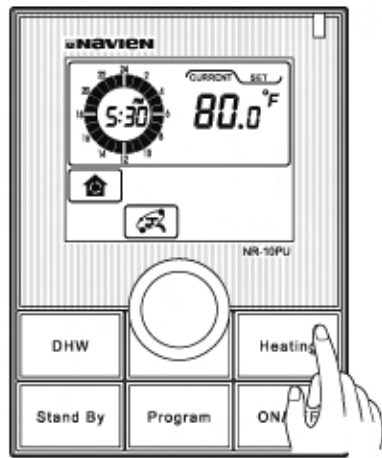

Tap "Heating" until "room temperature heating" icon appears. Leave alone and the display will automatically set.

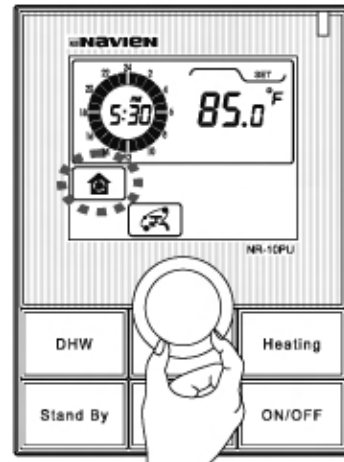

Tap "Heating" and when "room temperature heating" icon is blinking use the center dial to set the desired temperature between 50~100°F. Leave alone and the display will automatically set.

## ■ Return Temperature Controller (Options)

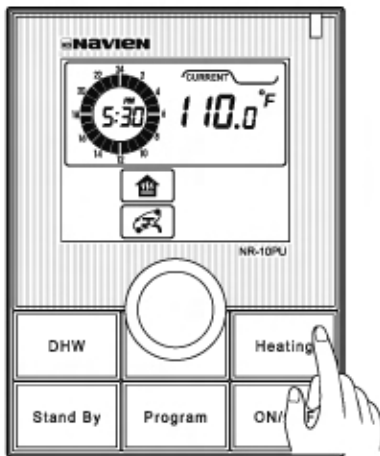

Tap the "HEATING" button until the "Return temperature heating" icon appears. Leave alone and the display will automatically set.

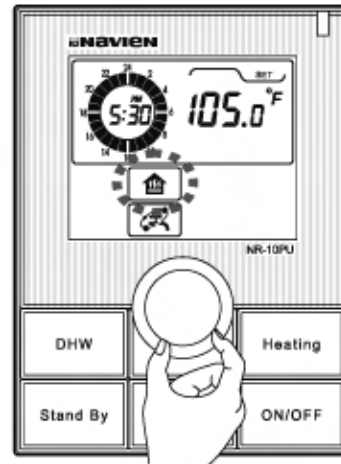

Tap "Heating" and when "Return temperature heating" icon is blinking use the center dial to set the desired temperature between 90~140°F. Leave alone and the display will automatically set.

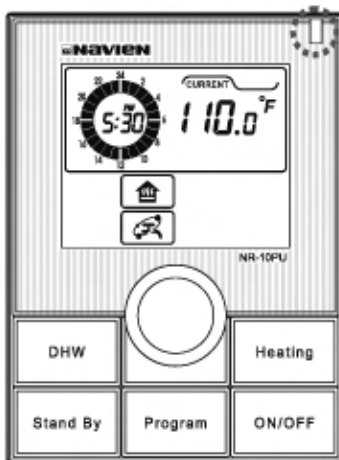

Depending on the setting temperature, the "ASA Control" automatically controls the heating operation. And the "green" LED indicator will turn on.

■ Supply temperature Controller (Option)

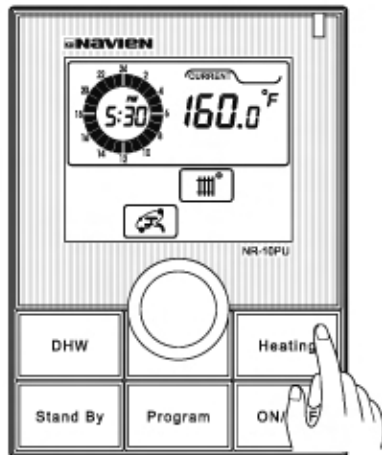

Tap "Heating" until "Supply temperature heating" icon appears. Leave alone and the display will automatically set.

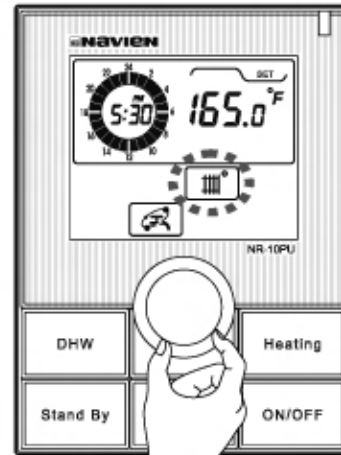

Tap "Heating" and when "Supply temperature heating" icon is blinking use the center dial to set the desired temperature between 105~185°F. Leave alone and the display will automatically set.

■ K Factor (Option)

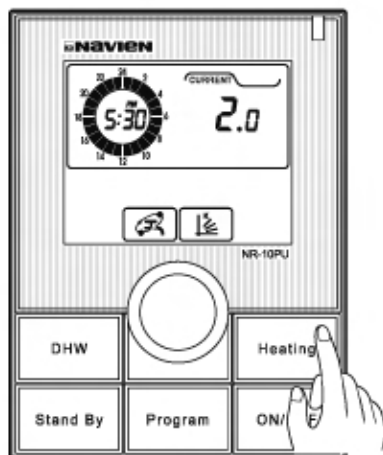

Tap "Heating" until "K Factor" icon appears. Leave alone and the display will automatically set.

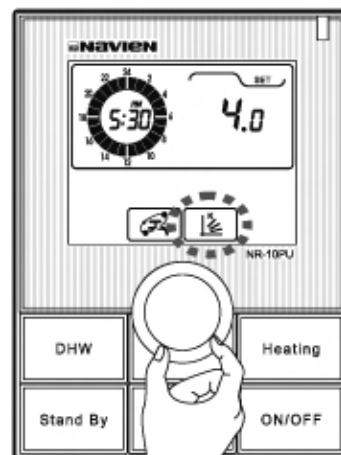

Tap "Heating" and when "K Factor" icon is blinking use the center dial to set the desired value between 0.5 ~ 6. Leave alone and the display will automatically set and return to its original state.

## PROGRAM(24h timer) Setting for Space Heating

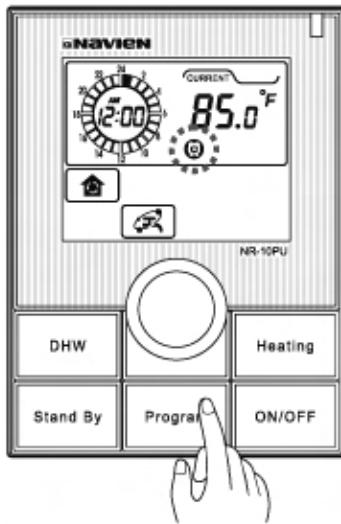

Tap the "PROGRAM" button to set the "24 hour" timer.

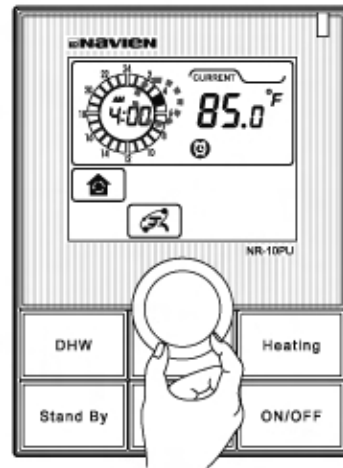

When the "clock" is flashing with the cursor, "■" use the center dial to move the cursor around.

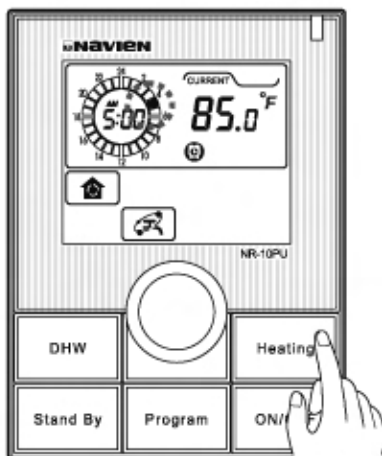

Tap the "HEATING" button to enable (solid) or disable (blank) the specified time frame. When a block is solid (■) the unit is enabled for that time frame.

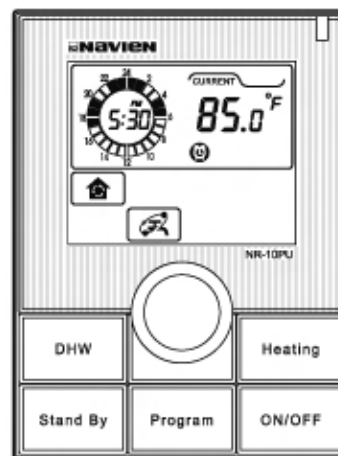

After setting the timer to the desired time frames, leave the remote alone and the display will automatically set the changes.

## ■ STAND BY

When the need for heat is not needed, the unit will set itself to operate in “stand by” mode.

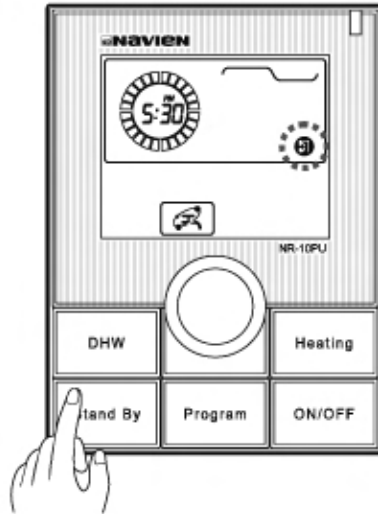

To Enable: Tap “STAND BY” and the “stand by” icon will appear.

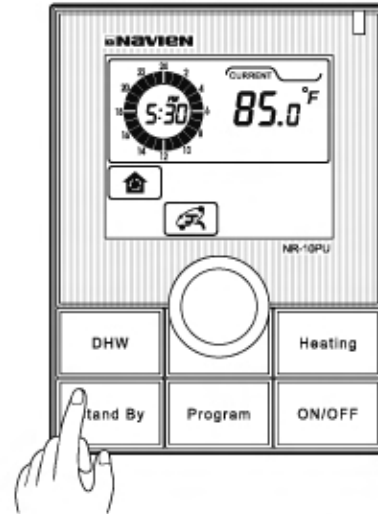

To Disable: Tap “STAND BY” and the “stand by” icon will disappear and the display will return to its original state.

## ■ Lock

This feature is a safety feature to prevent children from altering the settings which may in turn lead to harmful activity by the unit.

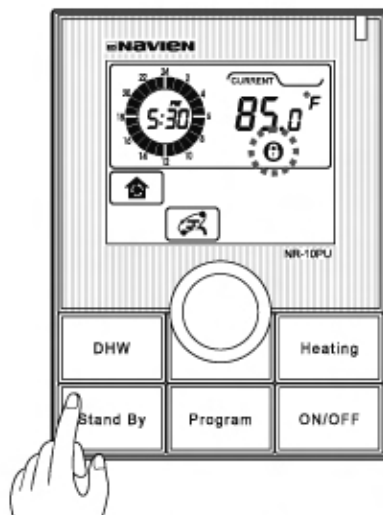

To Enable: Press and hold “STAND BY” for 3 seconds and the “lock” icon will appear.

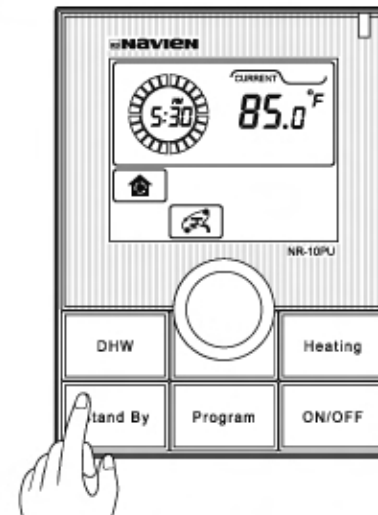

To Disable: Press and hold “STAND BY” for 3 seconds and the “lock” icon will disappear and the display will return to its original state.

## Heat Capacity Control

When the heating capacity is small, the desired heat capacity can be controlled by the use of the remote controller.

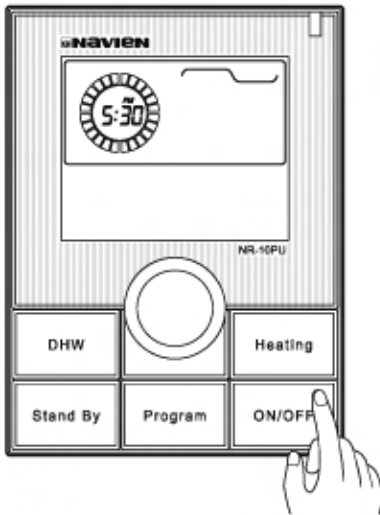

Tap "ON/OFF" to turn off the power of the remote controller.

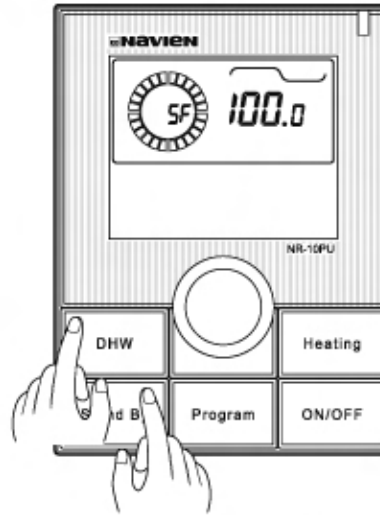

With the remote Controller off, press and hold the "DHW" and "Stand By" button simultaneously for 3 seconds. The black cursor should make 1 revolution around the clock and the heat capacity will be displayed on the right hand side of the clock.

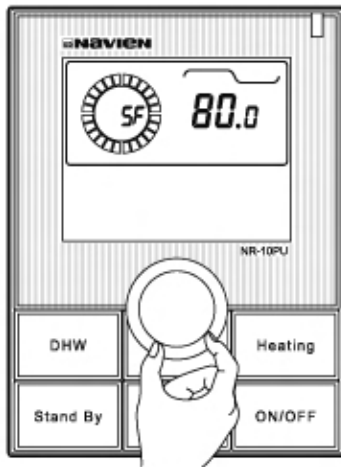

Use the center dial to adjust the heat capacity.(Range 30 ~ 100 %)

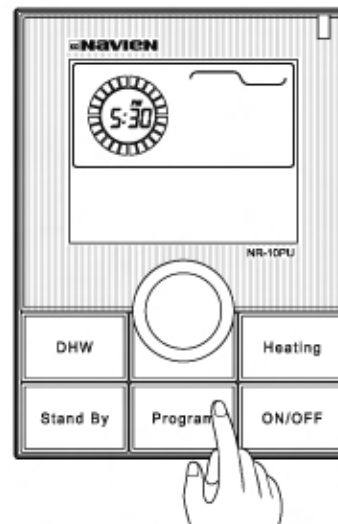

Press "Program" button to complete setting. If setting is completed R/C will return "OFF" state.

## ■ Capacity Control of The Whole

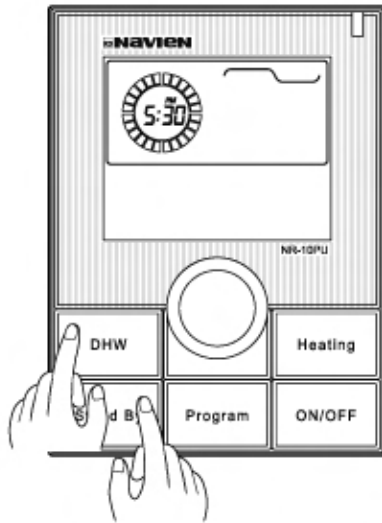

Please turn off the power of Remote Control by pressing ON/OFF button.

If the DHW and Stand By buttons are pressed simultaneously, the system goes into 'HEAT CAPACITY CONTROL' mode.

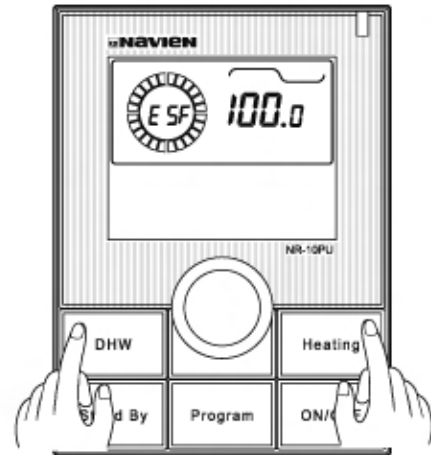

At this time, press the DHW and Heating button simultaneously for 3 seconds. Then the clock rotates clockwise and the current heat capacity is displayed.

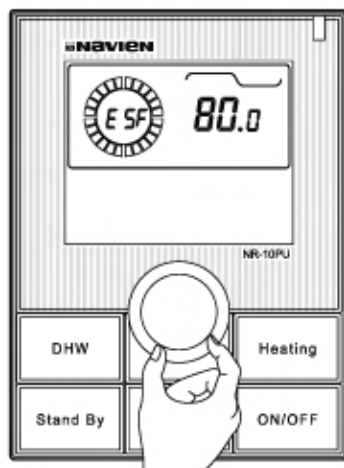

Use the center dial to adjust the heat capacity. (Range 30 ~ 100 %)



"Program" button to complete setting. If setting is completed R/C will return "OFF" state.



■ **Setting up the way of control of hot water**

Select which one will be used to control hot water temperature, supply water temperature or return water temperature.

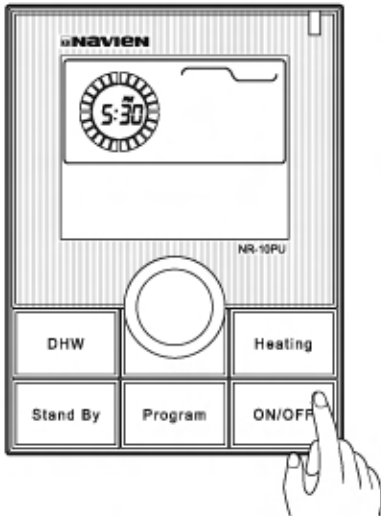

Please turn off the power of R/C by pressing ON/OFF button.

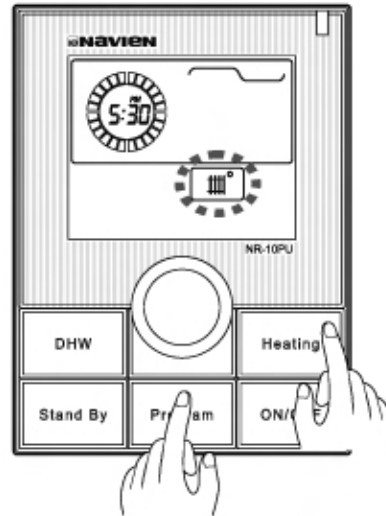

If the program and heating button are pressed simultaneously for 3 seconds, supply water (or return water) heating icon flickers.

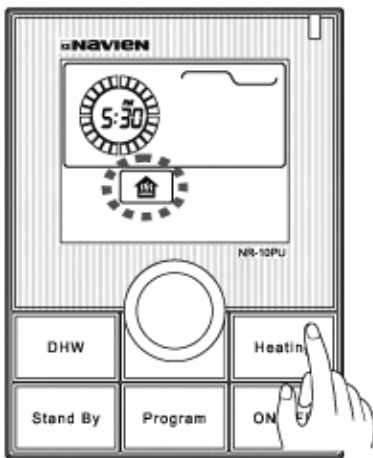

At this time if the heating button is pressed, the icon is changed to return water (or supply water)

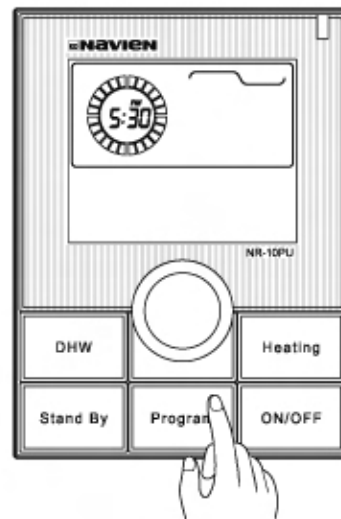

Leave the dial alone and the display will automatically save the savings and return to the "OFF" state.

## ■ Well pump setting

User can select whether well pump will be used or not.

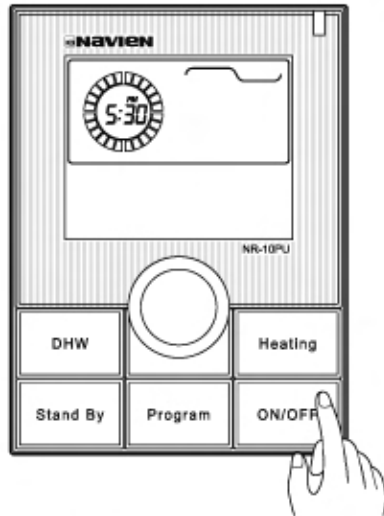

Please turn off the power of R/C by pressing ON/OFF button.

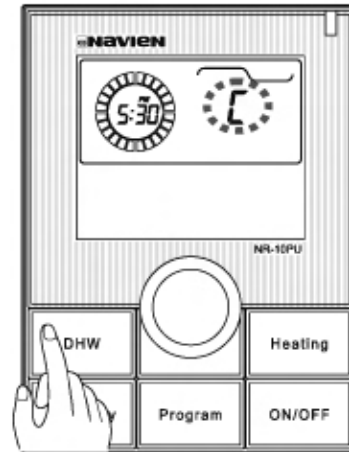

If the DHW button is pressed for 3 seconds, "IL P" is displayed inside the clock and "C" or "S" is flickered where the temperature is displayed. "C" means there is no WELL PUMP.

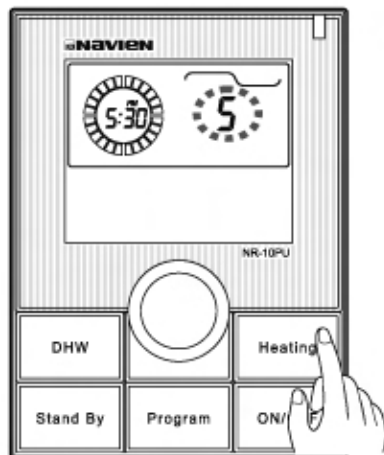

If the Well Pump setting needs to be changed, press the heating button to change "S" (or "C") to "C" (or "S").

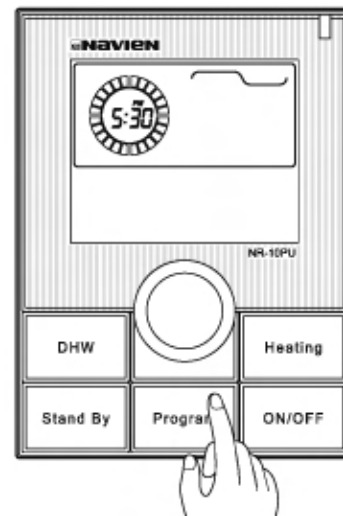

"Program" button to complete setting. If setting is completed R/C return "OFF" state.

## ■ Supply water pressure setting

Please follow the this procedure if setting up supply water pressure is needed

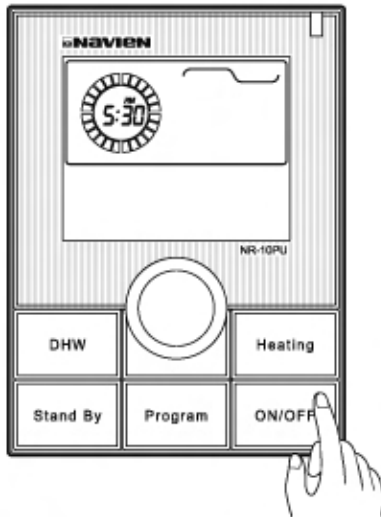

Please turn off the power of R/C by pressing ON/OFF button.

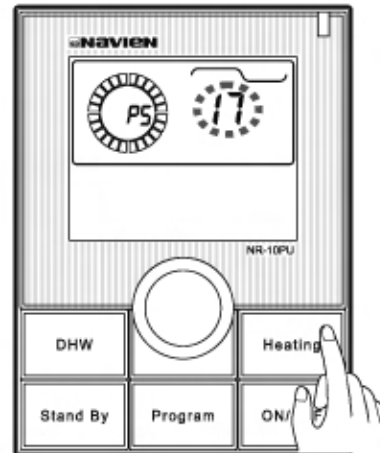

If the heating button is pressed for 3 seconds, "PS" is displayed inside the clock and desired supply water pressure is flickered where temperature was displayed.

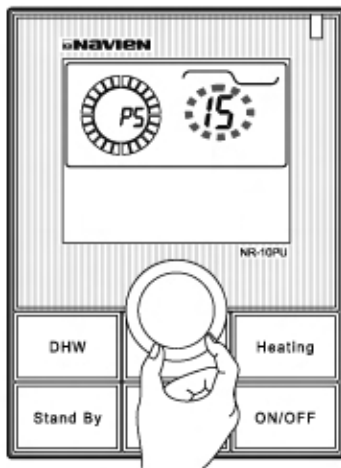

At this time, rotate dial to select desired supply water pressure, which shall be in the range of 12 and 30

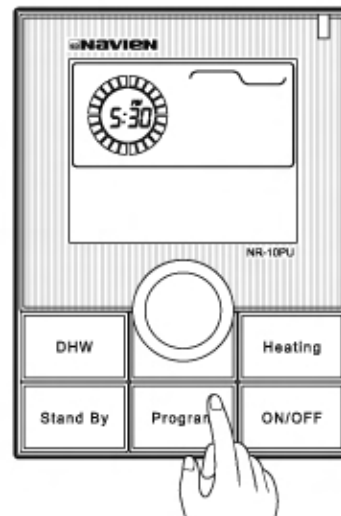

"Program" button to complete setting. If setting is completed R/C return "OFF" state.

■ **Function to set the number of initial  
Activating water heaters when cascade is used.**

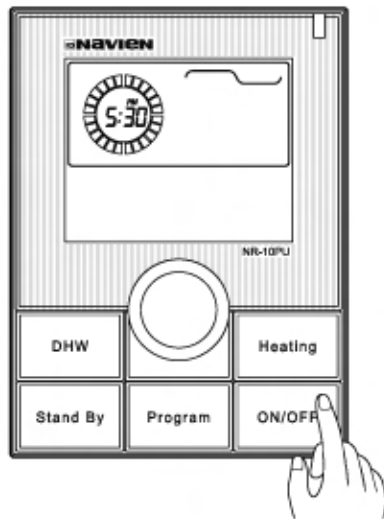

Please turn off the power of R/C by pressing ON/OFF button.

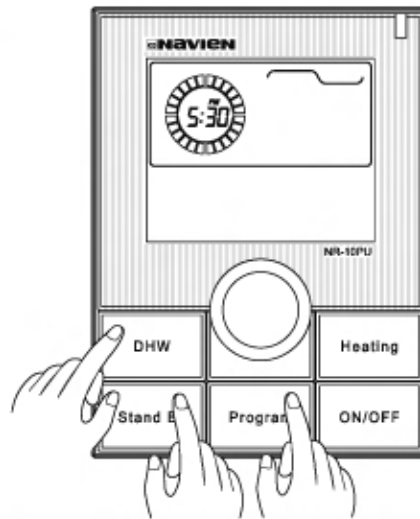

Press and hold "DHW", "Stand By" and "Program" buttons simultaneously for 3 seconds.

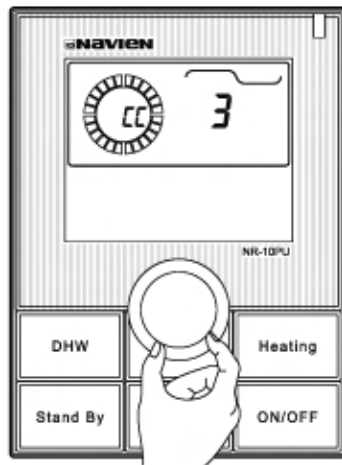

When number of operation is blinking on display panel, rotate dial to select the number of units to set initial operation

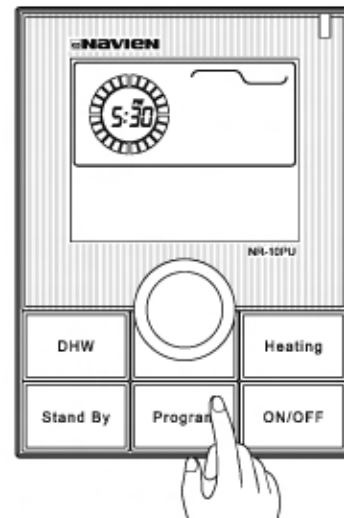

Press "Program" button to complete setting. If setting is completed R/C will return "OFF" state.

■ Function to set pump activating water heaters when cascade is used

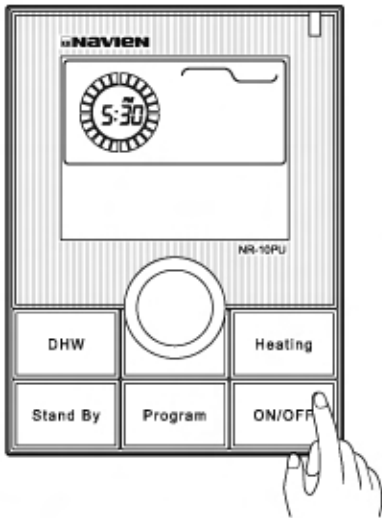

Please turn off the power of R/C by pressing ON/OFF button.

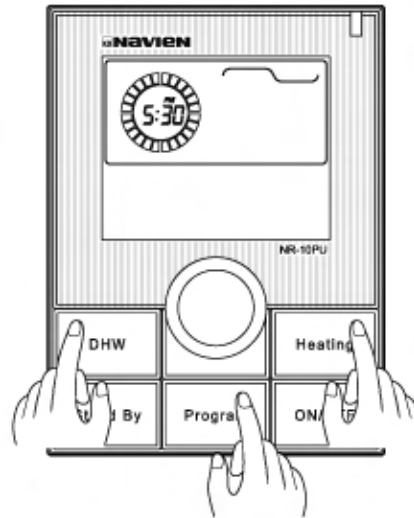

Press and hold "DHW", "Stand By" and "Heating" buttons simultaneously for 3 seconds.

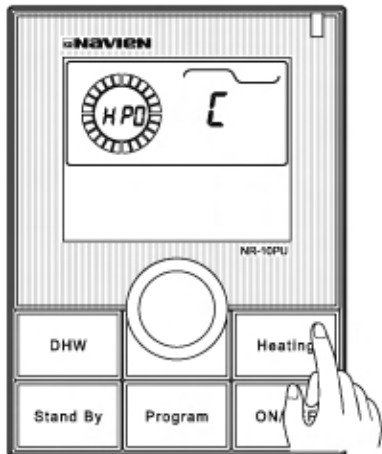

When the current setting state (C-disable, S-enable) is blinking, Press "Heating" button to change it's setting value.

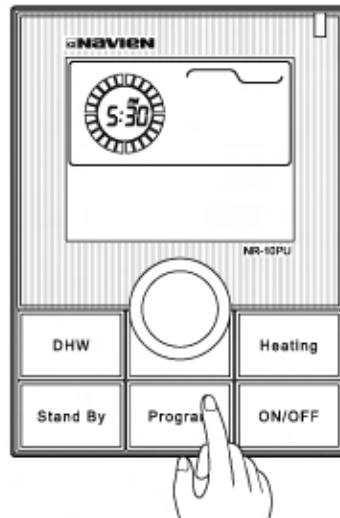

Press "Program" button to complete setting. If setting is completed R/C will return "OFF" state.

## Combination Water Heater: Heating (Mode)

The space-heating water is controlled by the thermostat. Provided which that enables the user to either set the desired room temperature required or set the heating water temperature. In some cases this thermostat may not be suitable for multi-system applications (The installing contractor will make this determination and install suitable alternative controls).

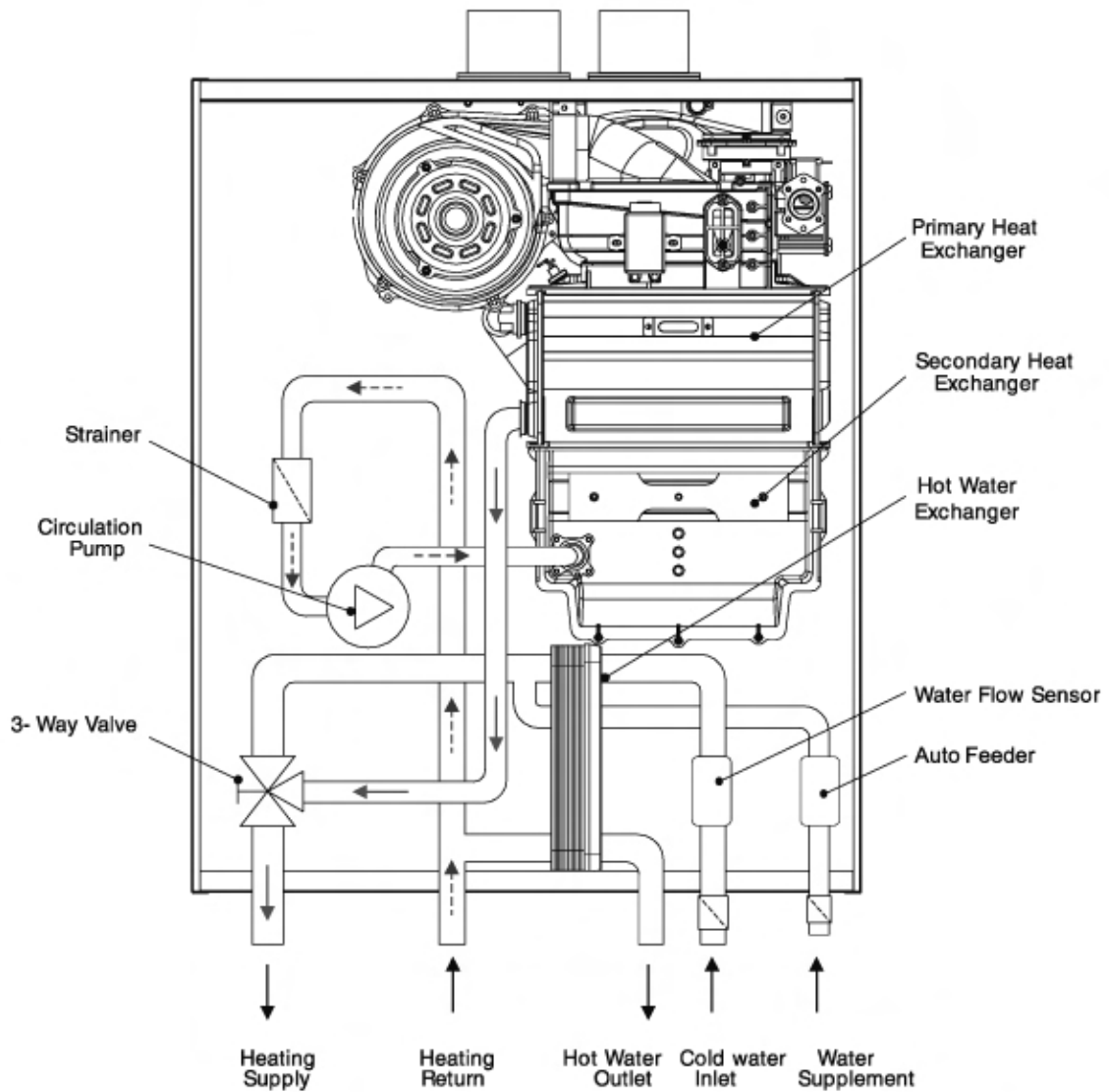

## Combination Water Heater: DHW (Mode)

The domestic hot-water (DHW) is controlled by the user. Because the Navien Combination Water Heater is a multi-purpose design, it can provide hot water on demand. The Navien Combination Water Heater will only produce hot water when you use it.

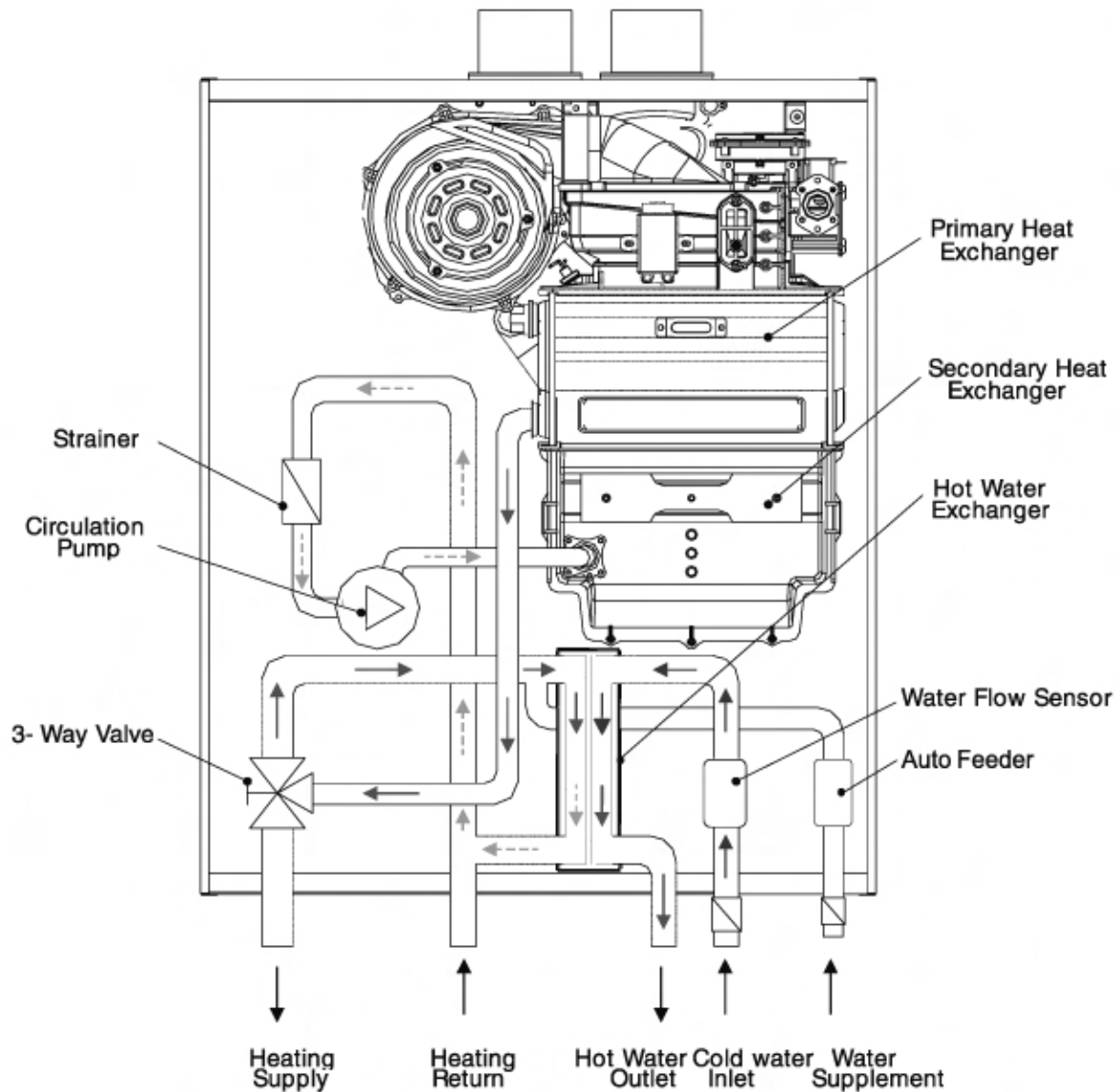

## Cleaning the combination water heater

### 1 Regular Maintenance:



#### CAUTION

Make sure the unit is OFF and the electrical power supply has been disconnected. The combination water heater may remain very hot for several minutes after it is turned off. To prevent burns, wait until the equipment has cooled down before inspecting or servicing.

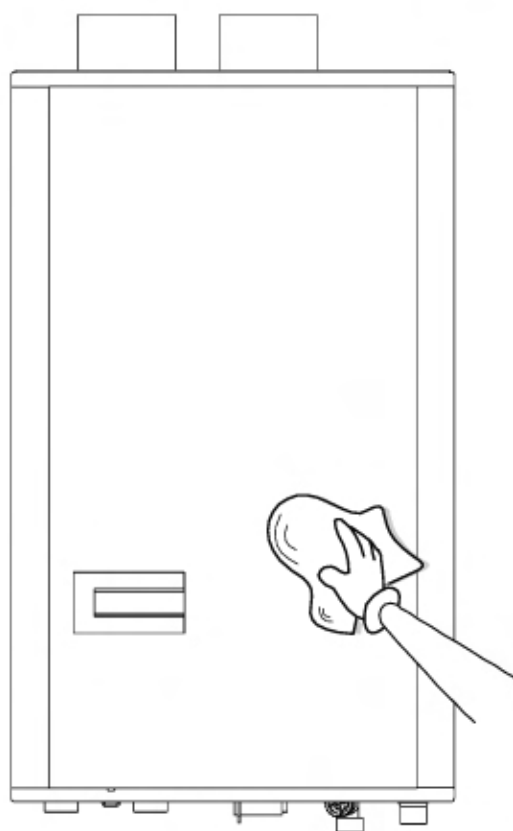

#### **Cleaning the combination water heater:**

Wipe the outside surface with a damp cloth. Use a mild detergent (non-acidic, non-abrasive cleanser) to remove any surface stains;

#### **Cleaning the Remote Controller**

Wipe the surface with a damp cloth. The remote controller is moisture resistant but NOT water proof. Keep it as dry as possible.



## Draining the combination water heater



### Draining the combination water heater - Parts you need to know:

Procedure to drain the combination water heater (figure below). You will need to prepare a bucket to collect some of the water to be drained.

1. Turn off the power to the unit.
2. Close the gas valve.
3. Close the water supply valve on the inlet to the unit. If there is no valve, turn off the water supply at the water meter.
4. Open the drain plug on the pump and allow the water to drain.
5. Open the drain plug at hot outlet side; open the drain valves inside the unit; open the drain valve at the pump and remove the filter from the cold inlet side
6. When the water is completely drained, return the drain plugs and the inlet filter and close the drain valves inside the unit.

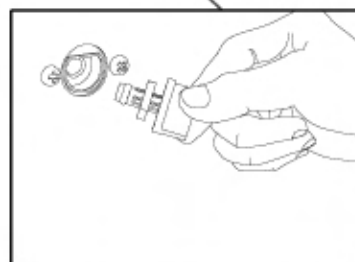
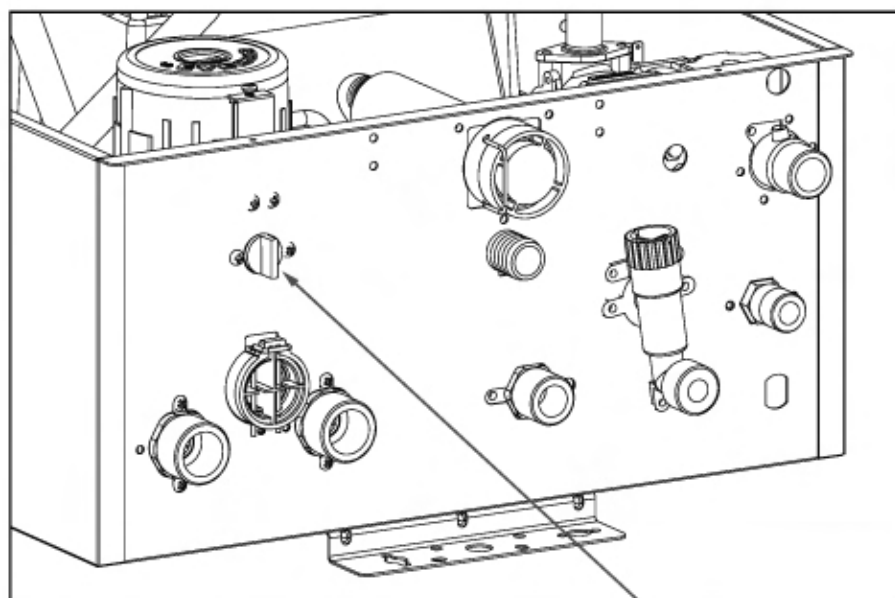

Pump Drain plug

## Auto feeder of the combination water heater

1. Make sure the drain plugs and the inlet filter have been inserted and that the drain valves inside the unit are closed.
2. Slowly open the water supply valve on the inlet to the unit. If there is no valve at the combination water heater, turn on the water supply at the water meter slowly.
3. Inspect and make sure there is no water leaking.
4. Combination water heater has an automatic feeder to fill water to the space heating side. It will fill automatically and stop. Please check the manual air release to make sure water filled properly.
5. Once all of the air has been bled out of the hot water lines, close all hot water faucets.
6. Turn power on to the unit.
7. Open the gas valve.
8. Open a hot water faucet to test for normal operation; the unit should fire and operate normally.

## Cleaning the Inlet Water Filter:



### Procedure:

Procedure to clean the cold water inlet filter (figure below). You will need to prepare a bucket to collect some of the draining water.

1. Turn off the power to the unit.
2. Close the water supply valve on the inlet to the unit.
3. Twist and remove the water filter
4. Clean the inlet filter by rinsing it under a faucet and scrubbing with a brush if needed.

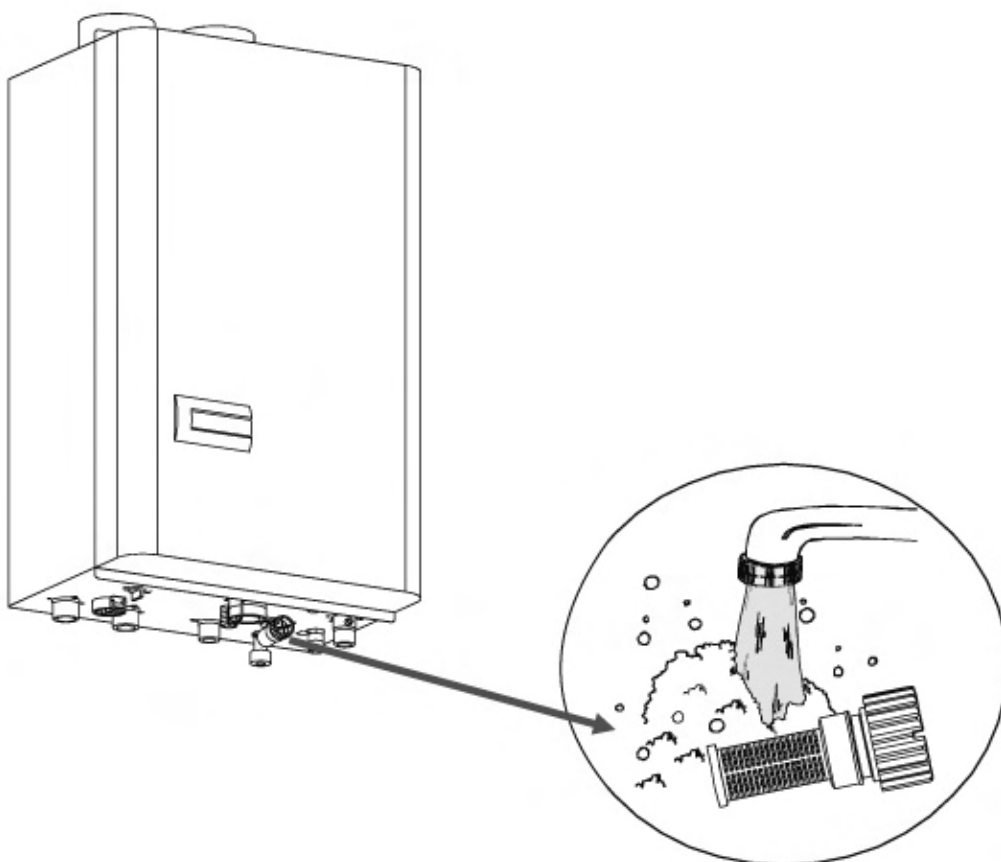

## Cleaning the Strainer

- ❑ **Strainer** : Increases heating performance by filtering impurities from the system. When heating performance is decreased, clean the filter by removing clip, Removing filter washing out and re-inserting the filter. Replace the clip!

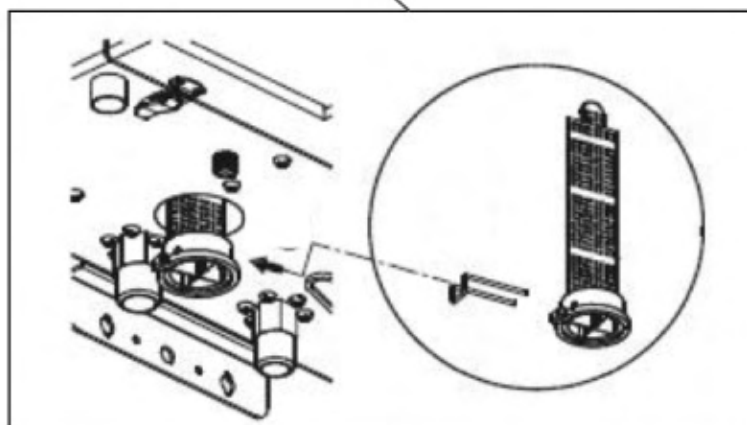
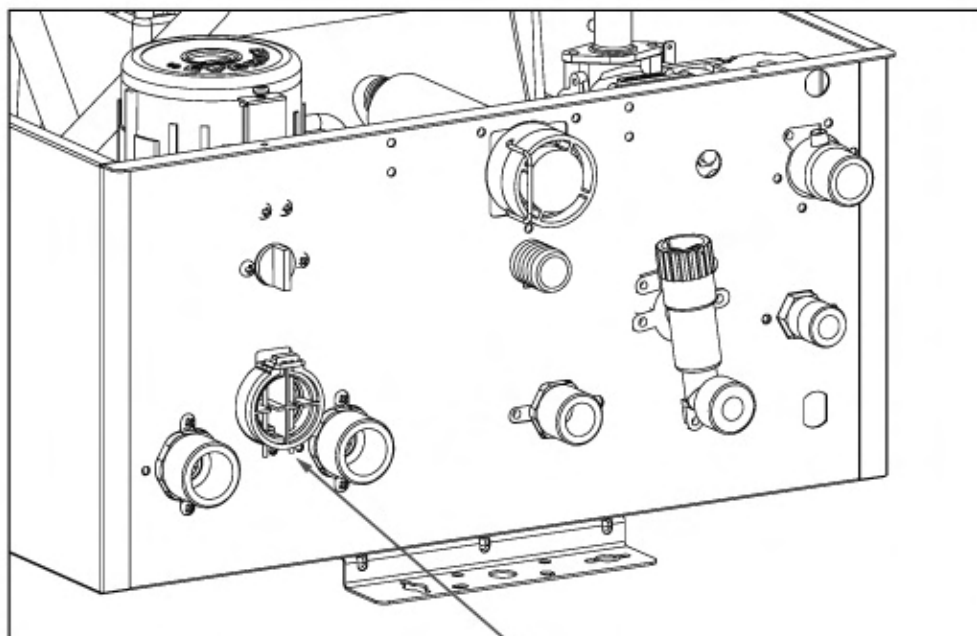

## Cleaning the Air-Intake Filter

✳ If an air intake filter is blocked by dust or pollen, the water heater will not operate and '10 Error' will be displayed. When this happens, please clean the water heater like the following.

1. Locate the air filter just above the fan and under the air intake pipe in the top left corner of the water heater.

2. To access the filter, there is one Philips screw that needs to be removed. The screw is located in the circled areas on the diagram to the right. Make note of which screw is taken. Once the screws are removed, then pull it out towards the front.

Air Intake Filter

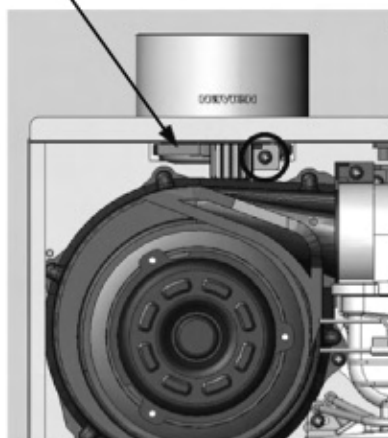

3. Remove the filter from the bottom of the intake pipe. Remove the Air Intake filter from the plastic assembly and clean it with a toothbrush and water. Re-fit the screen into the plastic assembly and fit the filter and frame onto the bottom of the air intake pipe.

Air Intake Filter

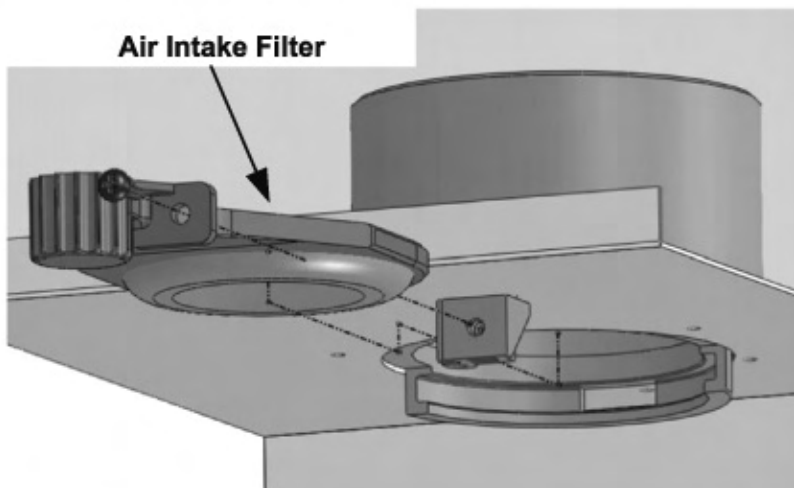

4. Once the filter is back on the intake, re-set the fan back to its original position (insert the fan on an angle into the back corner of the case and then move it into its correct position). Re-insert the screws into their original location.

# Optional Outdoor Temperature Sensor

- ❑ Detecting the outdoor temperature will make it possible to enjoy comfortable and convenient indoor life by operating the Combination Water Heater at the appropriate heating water temperature at a customized desired setting.
- ❑ The outdoor reset control operation (K-Factor) when enabled by connecting to the Navien CH unit can ensure that the system does not waste heat by exceeding current heat loss requirements, providing only the required fuel consumption, cerating loss pollution while saving you money.

## 1. K-Factor (Supply Temperature Setting)

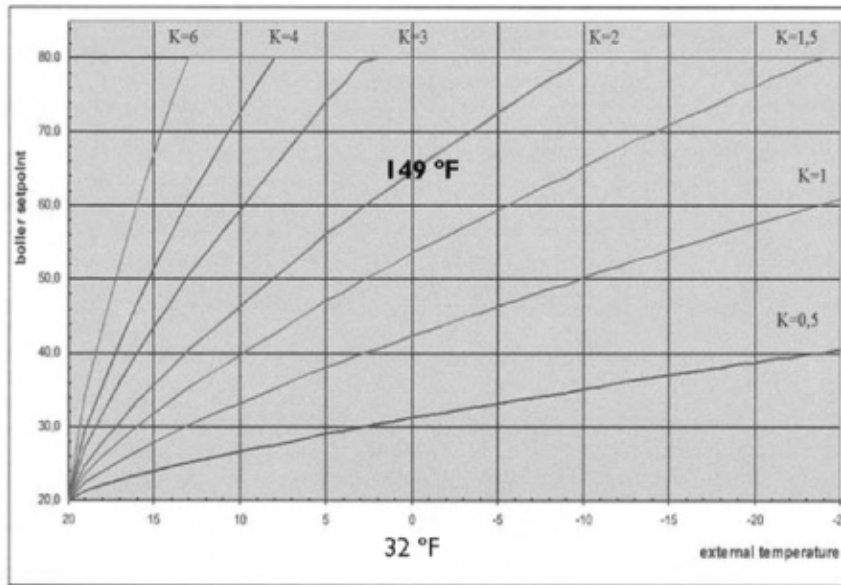

## 2. K-Factor (Return Temperature Setting)

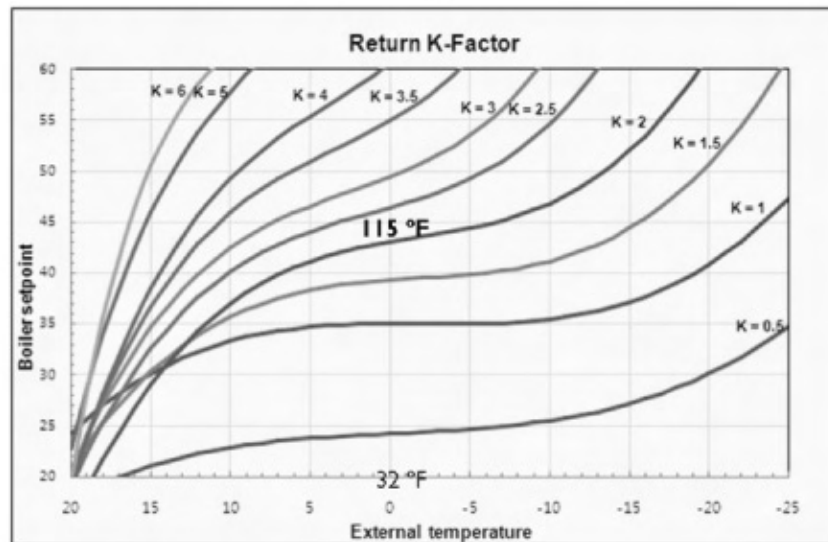

# Freeze Protection



## CAUTION

### Damage caused by freezing is NOT covered under Warranty

- ❑ Freezing damage will only occur if backdrafting is present caused by negative pressure within the building. This situation is not caused by the Navien Combination Water Heater and as such is not Navien's responsibility. Navien will not warrant any damage due to freezing. The installing contractor must be aware of this situation and ensure that there is sufficient make-up air to avoid such a situation.
  
- ❑ To avoid any freezing issues, Navien strongly recommends the use of Direct Vent. Ensure the exhaust vent pipe AND the air intake pipe are both connected directly from the combination water heater collars (top of unit) to the outdoors. This Direct Vent type installation will minimize any air movement within the unit.
  1. Do not unplug the electric power supply cord.
    - The freeze protection function requires electricity. If the combination water heater is installed in a cold area that experiences freezing temperatures and/or frequent power outages, drain the unit to avoid damage.
    - The freeze protection will operate regardless of whether the remote controller is ON or OFF.
  
  2. Insulate incoming and outgoing pipes to prevent freezing during cold seasons.
  
  3. Don't shut off the gas valve.
  
  4. Emergency methods for when inlet pipe is frozen:
    - During extreme cold seasons, when hot water is not able to flow, the inlet pipe may be frozen.
    - Using a hair dryer or heat gun, thaw the pipe to allow flow.



## FND Display

- ❑ LED read out shows supply water temperature and pressure for space heating in 5 Sec intervals, unless shows Error code.

## Basic Troubleshooting and Frequently Asked Questions

- ❑ If an 'Error Code' displays on the remote controller, follow the troubleshooting chart below before contacting your installer, service contractor or NAVIEN representative.
- ❑ Troubleshooting step #1 is to turn the unit OFF and then ON to reset the Navien combination water heater.
- ❑ If after resetting and following the steps outlined below, the combination water heater does not return to consistent operation, contact your installer, service contractor or Navien for service instructions.

Problem	Possible Cause(s)	What to do
There is no water at all when the hot water tap is opened.	<ul style="list-style-type: none"> <li>• Is the cold water filter clean?</li> <li>• Is the unit display flashing an error code?</li> <li>• Is the unit frozen?</li> </ul>	<ul style="list-style-type: none"> <li>• Make sure the shut-off valves on the hot and cold pipes are open.</li> <li>• Check if there is any error code flashing on the remote controller.</li> </ul>
When the tap is opened, there is no hot water or the hot water turns cold and stays cold.	<ul style="list-style-type: none"> <li>• Is the hot water fixture sufficiently open to draw at least 0.5 GPM through the combination water heater?</li> <li>• Is the unit display flashing an error code?</li> </ul>	<ul style="list-style-type: none"> <li>• Check if there is any error code flashing on the remote controller.</li> </ul>
The water is not hot enough.	<ul style="list-style-type: none"> <li>• Is the set temperature too low?</li> </ul>	<ul style="list-style-type: none"> <li>• Check unit's temperature setting.</li> <li>• Check for cross plumbing between cold and hot water lines.</li> </ul>
The water is too hot.	<ul style="list-style-type: none"> <li>• Is the set temperature set too high?</li> </ul>	<ul style="list-style-type: none"> <li>• Check unit's temperature setting.</li> </ul>



## Basic Troubleshooting and Frequently Asked Questions

Problem	Possible Cause(s)	What to do
Heating side malfunction (DHW works but Heating doesn't)	Is the setting temperature too low?	Use the center dial on the remote controller to raise the setting temperature.
	Is there power to the System, or is the system In stand-by?	Make sure the power is on, and plugged in to the outlet with the correct voltage. Tap "ON/OFF" then tap the heating button, and raise the setting temperature.
	Is the "24 hour" timer set correctly?	Make sure the current time setting is correct. Then adjust the timer settings to where the system is desired to run.
	Is the system running for domestic hot water (DHW)?	When the unit is heating for DHW, the heating side does not work. there is a standby time between switching form DHW and heating (3 min).
	Is the filter on the heating side restricted?	Clean out filters that belong to the heating side.
	Is the pre-heating icon blinking on the remote controller?	When the unit is in "pre-heating" mode the heating side is placed into stand by.

## Error Code Guide:

Error Code	Reason	Self-diagnostic / Action
E001	Water is boiling inside the heat exchanger	<ol style="list-style-type: none"> <li>1. Clean the inlet water strainer (part#55).</li> <li>2. Check the automatic flow adjustment valve(part#53).</li> <li>3. Check the heat exchanger; remove and clean with a cleaning solution.</li> </ol>
E002	Low pressure on heating side	<ol style="list-style-type: none"> <li>1. Turn off the system.</li> <li>2. Turn the unit back on.</li> </ol>
E003	Ignition failure	<ol style="list-style-type: none"> <li>1. Check to see if the main gas supply valve is open.</li> <li>2. Check that the power is "ON".</li> <li>3. Check the igniter for spark (part#34).</li> </ol>
E004	False flame detection	<ol style="list-style-type: none"> <li>1. Ensure ground wire is connected.</li> <li>2. Check the igniter for spark.</li> </ol>
E005	Heating supply outlet : Thermistor-open	<ol style="list-style-type: none"> <li>1. Check the thermistor.</li> <li>2. Replace the thermistor.</li> </ol>
E006	Heating supply outlet : Thermistor-closed	<ol style="list-style-type: none"> <li>1. Check the thermistor.</li> <li>2. Replace the thermistor.</li> </ol>
E007	Hot water outlet: thermistor -open	<ol style="list-style-type: none"> <li>1. Check the thermistor(part#62).</li> <li>2. Replace the thermistor.</li> </ol>
E008	Hot water outlet: thermistor -short	<ol style="list-style-type: none"> <li>1. Check the thermistor.</li> <li>2. Replace the thermistor.</li> </ol>
E009	Abnormal fan motor activity	<ol style="list-style-type: none"> <li>1. Check and clean the air filter(part#9).</li> <li>2. Check and clean the fan motor (part#21).</li> </ol>
E010	Abnormal air pressure	<ol style="list-style-type: none"> <li>1. Check the vent pipe for obstructions.</li> <li>2. Check and clean the air filter (part#9).</li> </ol>
E011	High pressure on heating side	<ol style="list-style-type: none"> <li>1. Turn off the system.</li> <li>2. Remove pump plug</li> <li>3. Drain water to release pressure</li> <li>4. Re-plug the pump</li> <li>5. Turn the unit back on.</li> </ol>
E012	Flame loss	<ol style="list-style-type: none"> <li>1. Check the main gas line (valve open?).</li> <li>2. Check intake air pipe.</li> <li>3. Check ground wire.</li> <li>4. Check power supply.</li> </ol>
E013	Abnormal Pump Activity	<ol style="list-style-type: none"> <li>1. Check the pump.</li> <li>2. Replace the pump.</li> </ol>
<p>If any of the above solutions do not resolve the problem with the combination water heater, contact Navien's Technical department at 1-800-519-8794.</p>		

## Error Code Guide:

Error Code	Reason	Self-diagnostic / Action
E015	Abnormal control board	1. Check power supply 2. Check the Emergency switch
E016	Overheating of heat exchanger	1. Turn OFF the system for at least 30 minutes then restart 2. Clean the inlet water strainer (part#55) 3. Check the automatic flow adjustment valve(part#53) 4. Check the heat exchanger; remove and clean with a cleaning solution
E018	Heating return inlet: Thermistor-open	1. Check Thermistor 2. Replace Thermistor
E019	Heating return inlet: Thermistor-short	1. Check Thermistor 2. Replace Thermistor
E021	Cold water inlet: Thermistor-open	1. Check Thermistor 2. Replace Thermistor
E022	Cold water inlet: Thermistor-short	1. Check Thermistor 2. Replace Thermistor
E027	Abnormal activity of the air pressure sensor	1. Check the vent pipe for obstructions 2. Check and clean the air filter (part#9)
E028	Pipe leak on heating side	1. Check pipes on heating side
E030	Exhaust Overheat: exhaust high limit switch shuts down the unit when the flue temperatures exceed 149°F (65°C)	1. Turn OFF the system for at least 30 minutes then restart 2. Clean the inlet water strainer (part#55) 3. Check the automatic flow adjustment valve(part#53) 4. Check the heat exchanger; remove and clean with a cleaning solution.
E035	Abnormal activity of the gas pressure sensor	1. Check gas line.
E036	Communication Failure	1. Contact to Navien tech. dept.
E039	Abnormal the Water Flow Sensor	1. Check the water flow sensor
E040	Outdoor Temperature Sensor – short (display only computer board)	1. Check Outdoor sensor 2. Replace

There will be error codes displayed on the remote controller and on the computer board (within the unit) of any problems or failures that occur with the combination water heater.

**NOTE:** To reset the combination water heater, either unplug and re-plug the electric supply or if a remote controller is installed, press the power button of the remote controller "OFF" then "ON".

# MEMO

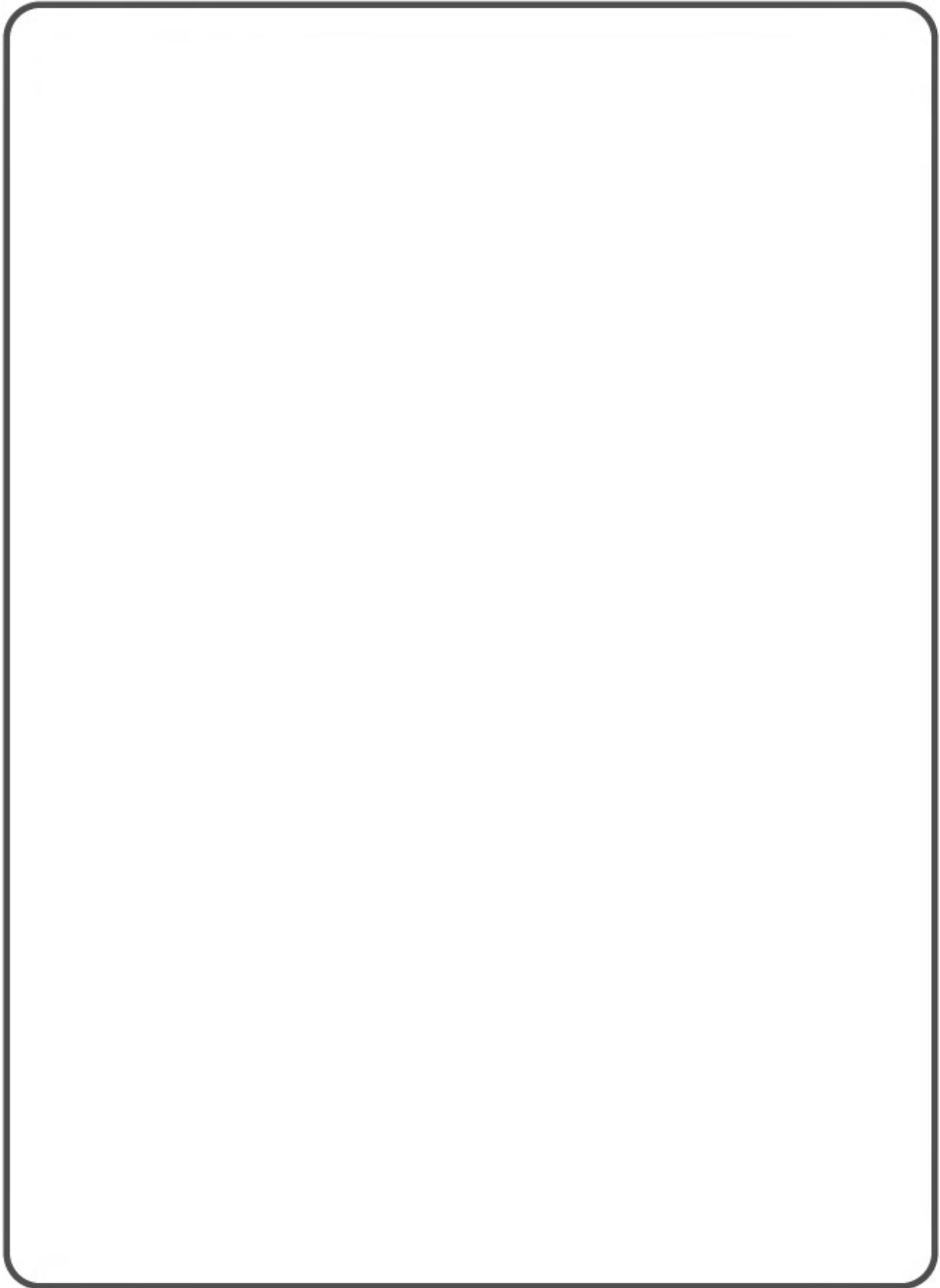

# MEMO

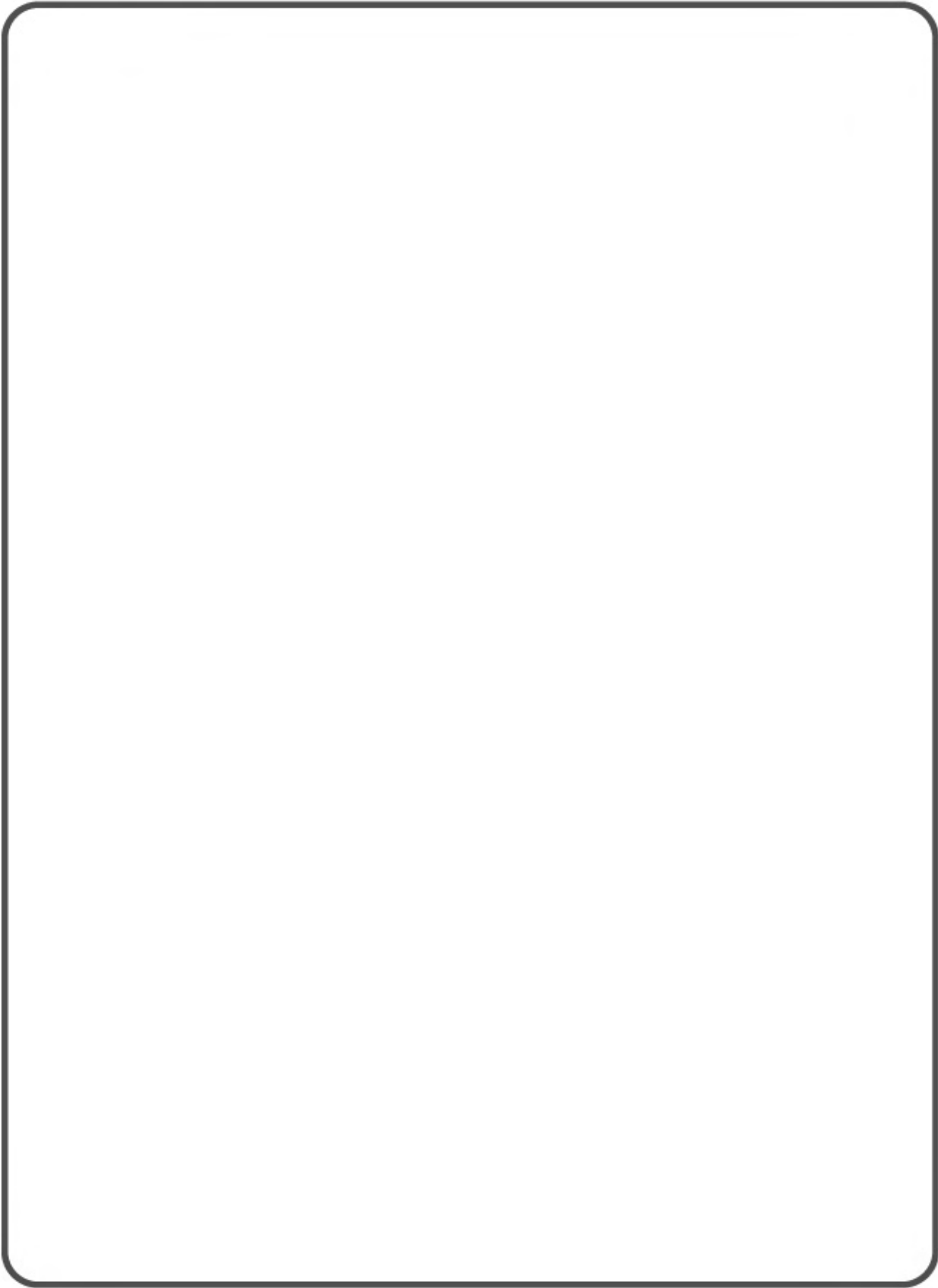

# MEMO

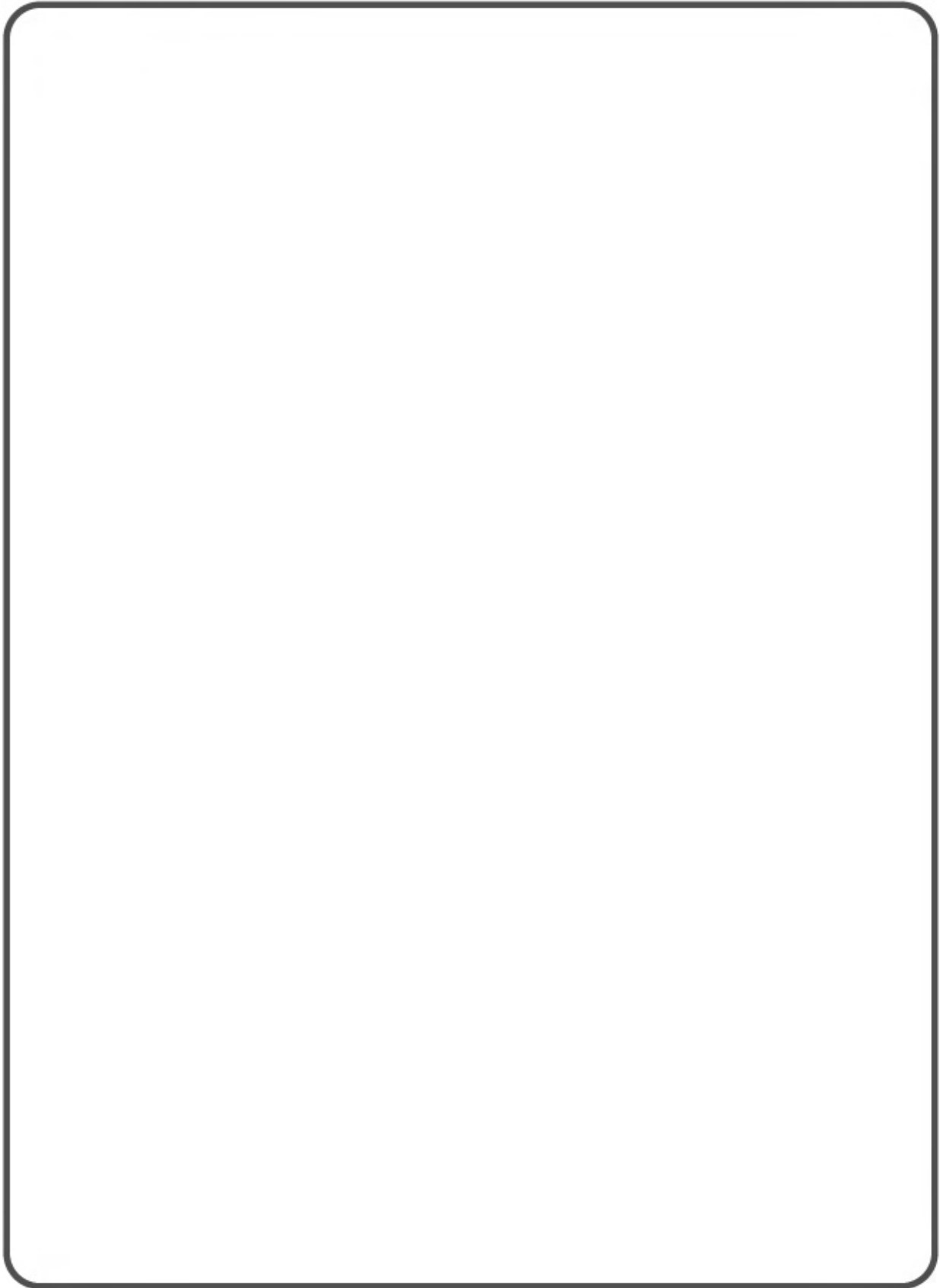

## Service

- ▶ Should you have any questions about this Navien water heater or if your water heater requires adjustment, repair or routine maintenance, it is suggested that you first contact the original installer. In the event the firm is unavailable, please refer to the contractor locator section of the Navien website ([www.navienamerica.com](http://www.navienamerica.com)) or contact to the Navien America Inc. Service Department:

**Navien America Inc**  
**1371 Santa Fe Drive**  
**Tustin CA 92780**  
**Tel: 714 258 9005, Fax: 714 258 9010**

- ▶ When contacting the manufacturer, please have the following information ready:
  - ① Model and serial number of the water heater as shown on the rating plate (located on the back side of the front cover);
  - ② Address where the water heater is physically located;
  - ③ Name and address of original installer and any service agency who has performed service on the water heater;
  - ④ Date of original installation and dates of any service work was performed;
  - ⑤ Details of the problem as best as you can describe them;
  - ⑥ List of people, with dates, who have been contacted regarding your problem.

Condensing  
**NAVIENT**  
Navigating Energy and Environment

***Navient Gas Combination Water Heater***



Navient America Inc.  
1371 Santa Fe Drive, Tustin CA 92780  
Tel: 714 258 9005, Fax: 714 258 9010, Toll Free: 1-800-519-8794  
[www.NavientAmerica.com](http://www.NavientAmerica.com)