

CE

Wall hung combination boiler

PROTHERM 23 BTVE



*User, Installation
and Servicing Instructions*

PROVITHERM 23 BTVE

The boiler serial number is marked on the label attached to the inside of the drop down door. Refer to the 'Introduction' section for a description of the basic functions of the boiler. The 'Users' section describes how to safely operate the boiler.

Instructions for Use

Introduction	2
Control and signalling	3
Boiler Start and Switch-Off	4
Warranty conditions	4

Instructions for Installation and Servicing

Introduction	5
Dimensions and pressure available	6
Technical parameters	7
Boiler schematic	8
Terminal position	9
Heating and hot water design	10
Boiler installation	12
Flue gas and air ducts	13
Electrical part	16
Commencing boiler operation	17
Safety devices	19
Cleaning and inspections	20
Replacement of boiler parts	24
Electrical diagrams	33
Defects	34

Mandatory warning for CEE countries

Warning: This appliance is designed, approved and inspected to meet the requirements of the market. The identification plate located on the inside of the appliance **certifies the origin** where the product was manufactured and the **country** for which it is intended.

If you see any exception to this rule, please contact your nearest dealer.
Thank you in advance for your assistance.

CE Mark

This boiler meets the requirements of Statutory Instrument No. 3083 The boiler (Efficiency) Regulations, and therefore is deemed to meet the requirements of Directive 92/42/EEC on the efficiency requirements for new hot water boilers fired with liquid or gaseous fuels.

Type test for purposes of Regulation 5 certified by: Notified body 0063.
Product/production certified by: Notified body 0063.

The CE mark on this appliance shows compliance with:

1. Directive 90/396/EEC on the approximation of the laws of the Member States relating to appliances burning gaseous fuels.
2. Directive 73/23/EEC on the harmonization of the Laws of the Member States relating to the electrical equipment designed for use within certain voltage limits.
3. Directive 89/336/EEC on the approximation of the Laws of the Member States relating to electromagnetic compatibility.

Dear Customer,

You have become an owner of a wall-hung combination boiler. The boiler PROVITHERM 23 BTVE with forced flue gas removal is designed for heating up the central heating water (CH) in central-heating systems in flats, family houses, workshops, offices, etc. and as a flow heater of domestic hot water (DHW). We believe it will serve you to your full satisfaction – certain minimum requirements must be fulfilled to that end. That is why we are asking you to study and follow these instructions carefully.

Please, keep the following rules in mind:

- The boiler and all accessories must be installed and used in compliance with the design, the applicable laws, technical regulations and the manufacturer's instructions.
- The boiler can only be installed in the type of environment for which it is designed.
- Only service centres authorised by the manufacturer are allowed to put the boiler into operation after installation.
- In case of defects, call a service centre authorised by the manufacturer – incompetent intervention can damage the boiler (and/or the accessories)!
- The service centre's employee who initiates the boiler operation after installation shall instruct the user about the boiler, its parts and operation.
- Check completeness of the delivery.
- Check to make sure the supplied boiler type complies with the expected manner of use.
- If you feel uncertain about any activities related to the boiler operation, look up and study all relevant information in these instructions, and follow the recommended procedure.
- Do not remove or damage any labels or markings on the boiler.
- When the life cycle of the boiler, or its parts, has expired, they should be disposed of in an environmentally friendly manner.

In practice, situations may occur in which the users must apply necessary precautions:

- Preventing the boiler from switching on (also accidental) when inspecting the flue-gas duct, water and gas piping – i.e., electricity supply to the boiler must be stopped (e.g., by unplugging) in addition to using the boiler switch;
- Stopping the boiler whenever flammable or explosive vapours appear (even if temporarily) – such as vapours of flooring glue, paints when surface finishing, gas leaks, etc.);
- If it is necessary to discharge water from the heating system, it must not be dangerously hot;
- If water has leaked from the boiler exchanger, or if the exchanger is filled with ice, no attempts to start the boiler should be made until normal operating conditions prevail;
- If there is a (whether confirmed or suspected) gas leak or stoppage in the gas supply, switching off the boiler, shutting down the gas supply and calling gasworks or a specialised service centre.

Safety of life and property:

- Boilers as products are checked for compliance with the following documents: EN 483, EN 437, EN 625, EN 50 165, EN 60 335-1:1997.
- The installation of this boiler must be carried out by a competent person in accordance with the relevant requirements of the current issue of:
 - The Gas Safety (Installation and Use) Regulations
 - The Building Regulations
 - The local water company Bylaws
 - The Building Standards Regulations
 - The Health and Safety at Work Act
- Besides the requirements as expressed in the above-cited documents, these Instructions for Use and the boiler documentation provided by the manufacturer are to be followed. During use, no children, drug-intoxicated or legally irresponsible persons should be allowed to tamper with the boiler.

Abbreviations used: CH – central heating water, DHW – domestic hot water.

USER INSTRUCTIONS

Control and Signalling

Your **Provitherm 23 BTVE** boiler has been factory configured to operate at the heart of an existing installation. However, because many installations are specially designed, do not hesitate to contact your installer who will be able to ensure that you get the best performance from your installation, by adjusting the heating circuit's maximum output or temperature. Once these settings have been made, you can still adjust the temperature to suit your needs.

Central heating adjustment

The selector switch enables you to vary the temperature of the water in the central heating circuit from the minimum setting (approx. 38°C) up to the maximum temperature set by your installer. Most of the time, the mid position will meet your needs but the selector should be moved nearer to the maximum setting in very cold weather when your home is not reaching the required temperature.

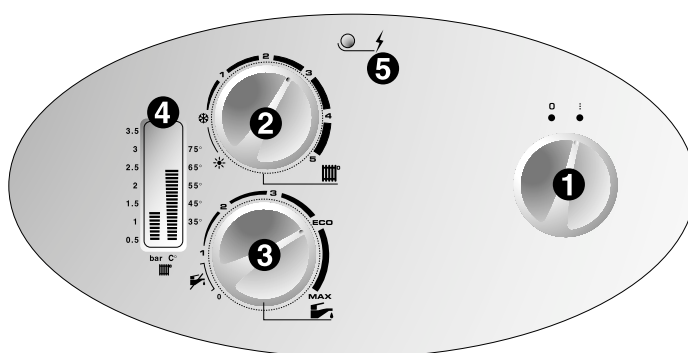

Diagram 1

Control Panel

- 1 - On/Off switch
- 2 - Central heating temperature selector
- 3 - Domestic hot water temperature selector
- 4 - Pressure gauge (bar) and temperature gauge (°C)
- 5 - Fault display (faults indicated by a red flashing light)

Domestic hot water

The selector switch can be adjusted from a temperature of (approx. 35°C up to 60°C or more). The **ECO** setting is ideally suited for all the requirements of normal family use (showers, washing up etc.). The maximum setting should be reserved for occasional use when very hot water is required.

Protection against freezing

The boiler has a built in frost protection programme as long as the electricity and gas are left switched on. If the temperature within the appliance falls to 4°C the burner and system pump are activated. When the temperature inside the appliance reaches 8°C the burner will shut down and after a short period the pump will stop. This device primarily protects the boiler. Any other exposed areas of the system should be protected by a separate frost thermostat.

If the boiler is to be out of use for any long periods during severe weather conditions, it is recommended that the whole system, including the boiler, be drained to avoid the risk of freezing.

If in doubt, consult your servicing company.

Draining and filling

Caution: The boiler is installed as part of a sealed system which must only be drained and filled by a competent person.

BOILER START AND SWITCH-OFF

The preparation for and commencing of the boiler operation may only be carried out by a specialised service centre!

Before starting the boiler when it has been put into operation, check the following facts:

- The power cord must be plugged into the socket.
- The gas valve that feeds the boiler must be open.
- The water pressure in the heating system should be between 1 and 2 bar.

Now the boiler is ready to be started.

Lighting the boiler:

Make sure that:

- The boiler is connected to the electrical supply.
- The gas service cock is open. Turn the switch **ON (I)**



Stop the boiler :

- Turn the switch **OFF (0)** the electrical supply is OFF.
- Turn the gas supply OFF at the gas service cock if the boiler is to be out of use for a long time.



Domestic hot water adjustment :

- **Position (0):** Domestic hot water OFF
- **Position (1) and ECO:** Domestic hot water between approx. 35°C and 50°C
- **ECO:** Maximum recommended for constant use
- **Between ECO and maxi:** Occasional use for water above approx. 50°C

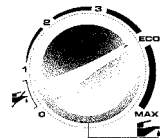

Heating temperature adjustment :

- **Winter:** Set the control knob between 1 and 5
- **Summer:** Set the control knob to *



If a fault occurs (indicated by red flashing light) :

- **Reset boiler:** Turn the On/Off switch to **(0)**, wait for five seconds. Turn the On/Off switch to **(I)** the boiler is reset. If the fault continues call your Installation/Service company.



Maintenance and inspections

Checks and maintenance on the boiler should be regular, at least once a year. Such inspections are not covered by the warranty. The Service Booklet contains a checklist for such inspections.

Cleaning

The boiler can be cleaned with a wet cloth and then dried and polished with a dry cloth. Never use any abrasives or thinners.

WARRANTY CONDITIONS

The warranty on PROVITHERM 23 BTVE boilers is provided as specified in the Guarantee Certificate, Service Booklet and under conditions specified in these Instructions for Use and Instructions for Installation (in chapters Introduction, Boiler installation).

INSTALLATION INSTRUCTIONS

Introduction

The **Provitherm 23 BTVE** boiler is a wall mounted modulating combination boiler with electronic ignition providing central heating and instantaneous hot water.

The boiler is of the **I2H** category for use with Natural Gas (G20). The boiler has a fan assisted balanced flue which both discharges the products of combustion to and draws the combustion air from the outside of the room. The boiler is suitable for top outlet flue connection only but can be fitted with horizontal flue, vertical flue or twin-pipe flue. Refer to flue options guide for further information, this is available from your nearest stockist. Both the central heating and domestic hot water temperature are user adjustable from the boiler control panel. Domestic hot water demand always has priority over heating demand. The pump, expansion vessel and associated safety devices are all fitted within the boiler. The boiler can be installed against either an external wall or on an adjacent inside wall, that is, the flue system will pass directly to the rear or to either side to the terminal fitted on the outside wall face. The installation must be carried out by a qualified registered person in accordance with the relevant requirements of The Building Regulations, The Water Byelaws, The Building Standards Regulations and any applicable local regulations. These instructions should be carefully followed for the safe and economical use of your boiler.

Electrical Supply

WARNING: This boiler must be earthed.

All system components shall be of an approved type and shall be connected in accordance with the current issue of appropriate norm and any applicable local regulations. All external wiring between the appliance and the electrical supply and earthing requirements shall comply with the current IEE Regulations.

Connection of the boiler and system controls to the mains supply must be through a common isolator and must be fused 3A, maximum. This method of connection must be by a fused double pole isolating switch, with a minimum contact separation of 3 mm on both poles. The switch should be readily accessible and preferably adjacent to the appliance. It should supply the appliance only and be easily identifiable as so doing.

Gas safety (Installation and use) Regulations

In your interests and that of gas safety, it is the law that ALL gas appliances are installed and serviced by a qualified registered person in accordance with the above regulations.

Gas leak or fault

If a gas leak or fault exists or is suspected, turn the boiler yoff and consult the local gas supply company or your installation/service company.

Air in the heating system

Persistent air in the heating system may indicate leaks in the system or corrosion taking place. Call your Installation/Service company.

Overheating safety

In the event of a problem, the overheating safety devices cause safety shutdown of the boiler. If this happens, call your Installation/Service company.

Boiler controls

The control panel, located at the lower front of the boiler casing, **see diagram 1**, allows the boiler to be started, shut down, controlled and monitored during use.

Flue

Do not obstruct the outside terminal of the flue.

Ancillary equipment

A range of flue accessories are available including vertical flues, twin-pipe flues, bends etc. For further information contact your supplier.

DIMENSIONS AND PRESSURE AVAILABLE

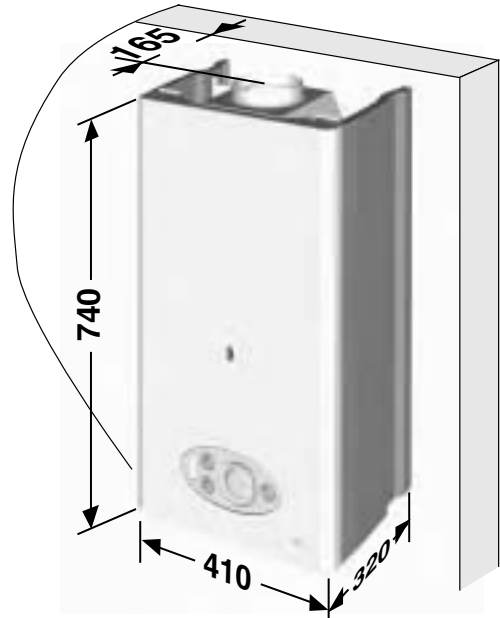

Net lift weight (boiler only) 36 kg
Gross lift weight (boiler and packaging) 37 kg

Diagram 3

- 1** Bypass fully shut
- 2** Open 1/4 turn
- 3** Open 1/2 turn
- 4** Open 1 turn
- 5** Open 2 turns

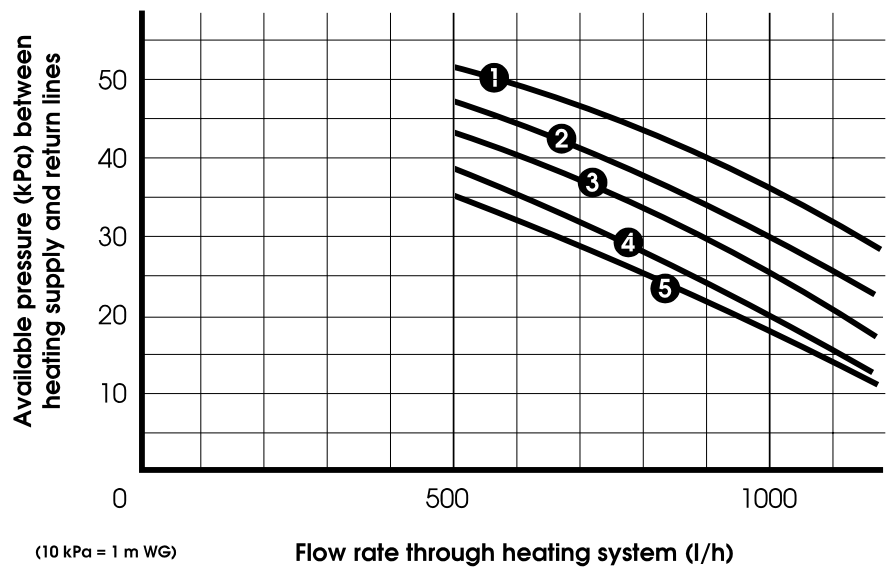

Diagram 4

TECHNICAL DATA – PROVITHERM 23 BTVE

Heating

Heat input (max) NET Q	25 kW / 85,300 BTU/H
Heat input (min) NET Q	10,4 kW / 35,490 BTU/H
Heat output (max) NET P	23 kW / 78,480 BTU/H
Heat output (min) NET P	8,7 kW / 29,670 BTU/H
Heat output (adjusted in manufacture) NET P	15 kW *
Efficiency	91%
Maximum heating temperature	80 °C
Expansion vessel effective capacity	5 l
Expansion vessel charge pressure	0,5 bar
Maximum system capacity at 75°C	70 l
Safety valve, maximum service pressure	3 bar

Hot water

Heat input (max) NET Q	25 kW / 85,300 BTU/H
Heat input (min) NET Q	10,4 kW / 35,490 BTU/H
Heat output (max) NET P	23 kW / 78,480 BTU/H
Heat output (min) NET P	8,7 kW / 29,670 BTU/H
Maximum hot water temperature	63 °C
Minimum hot water temperature	35 °C
Specific flow rate (for 30°C temp rise)	11L/min.
Threshold flow rate	1,7 L/min.
Maximum supply pressure	10 bar
Minimum supply pressure	0,5 bar

Combustion

Products outlet diameter	60 mm
Fresh air inlet diameter	100 mm

Electrical

Electrical supply	230 V ~ 50 Hz
Electrical rating	122 W fused at 3 A
Level of protection	IPX4D
Fuse rating	125 mA

Natural Gas (G20)

Ø Burner injector	1,2 mm
Inlet pressure	20 mbar
Maxi. Burner pressure	12 mbar
Mini. Burner pressure	2 mbar
Gas rate maximum	2,64 m ³ /h

* Note: Heat output adjusting – see section Servicing instruction

BOILER SCHEMATIC

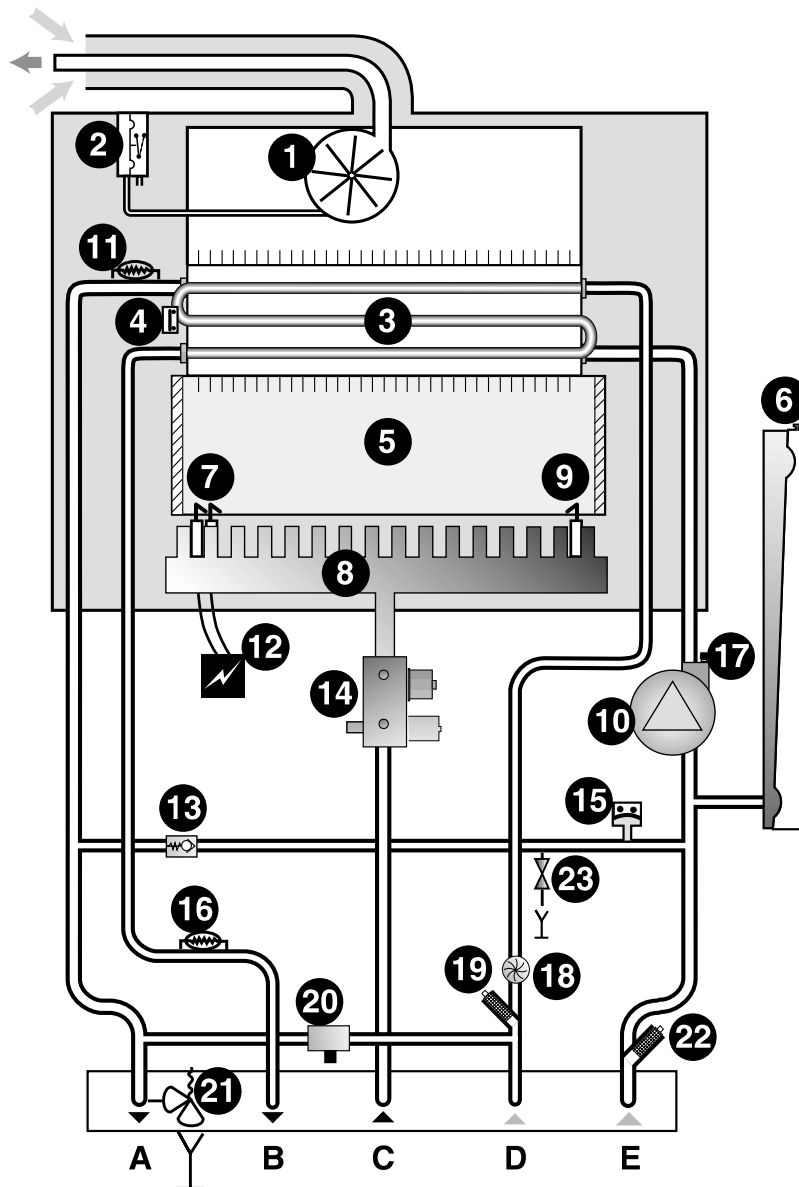

- | | | | |
|----|-----------------------|----|--------------------------------|
| 1 | Fan | 15 | Loss of water sensor |
| 2 | Air pressure switch | 16 | Domestic hot water thermistor |
| 3 | Heat exchanger | 17 | Automatic air vent |
| 4 | Overheat thermostat | 18 | Domestic water flow sensor |
| 5 | Combustion chamber | 19 | Filter cold water inlet |
| 6 | Expansion vessel | 20 | Filling system |
| 7 | Ignition electrode | 21 | Discharge safety valve (3 bar) |
| 8 | Burner | 22 | Heating filter |
| 9 | Flame sense electrode | | |
| 10 | Pump | A | Heating flow |
| 11 | Heating thermistor | B | Domestic hot water outlet |
| 12 | Ignition module | C | Gas |
| 13 | By-pass | D | Cold water inlet |
| 14 | Gas valve | E | Heating return |

Diagram 5

Flue terminals possibilities

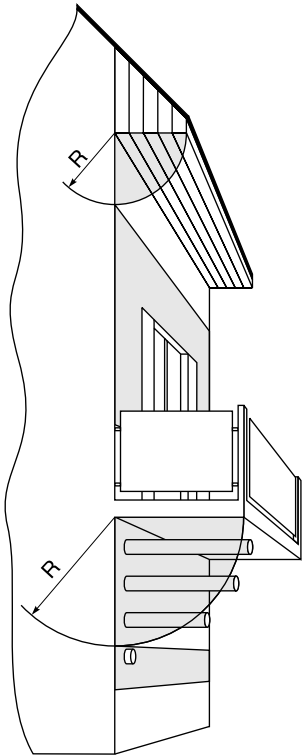
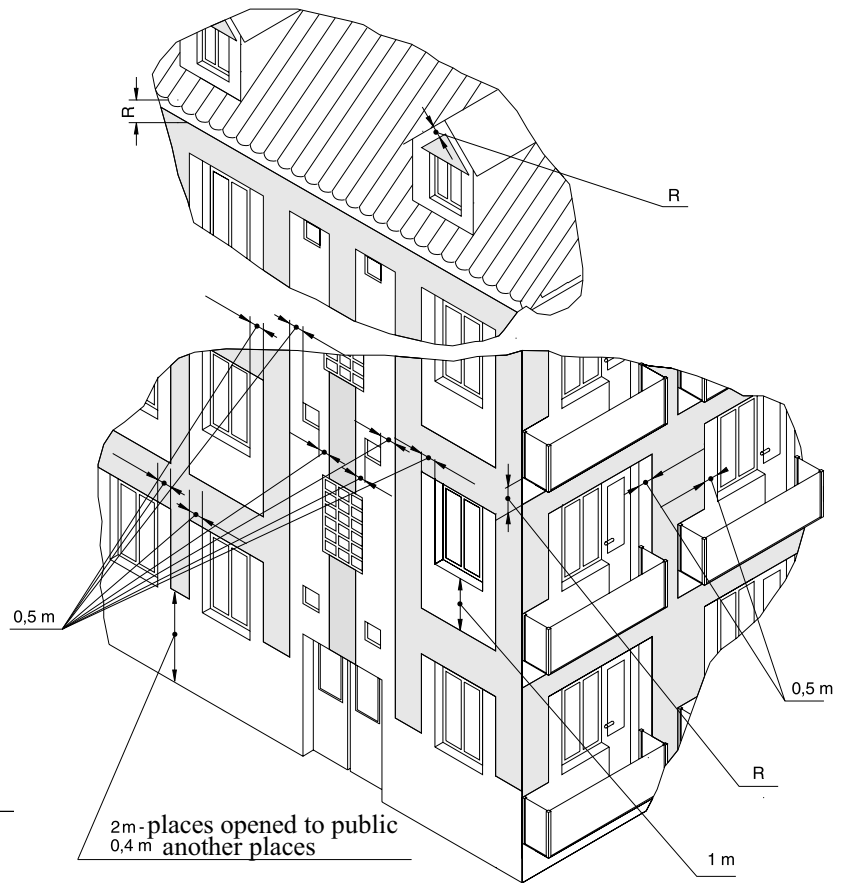

Diagram 8 - Overhang



■ - places for the positioning of flue terminals

Diagram 9 - Positioning on the facade

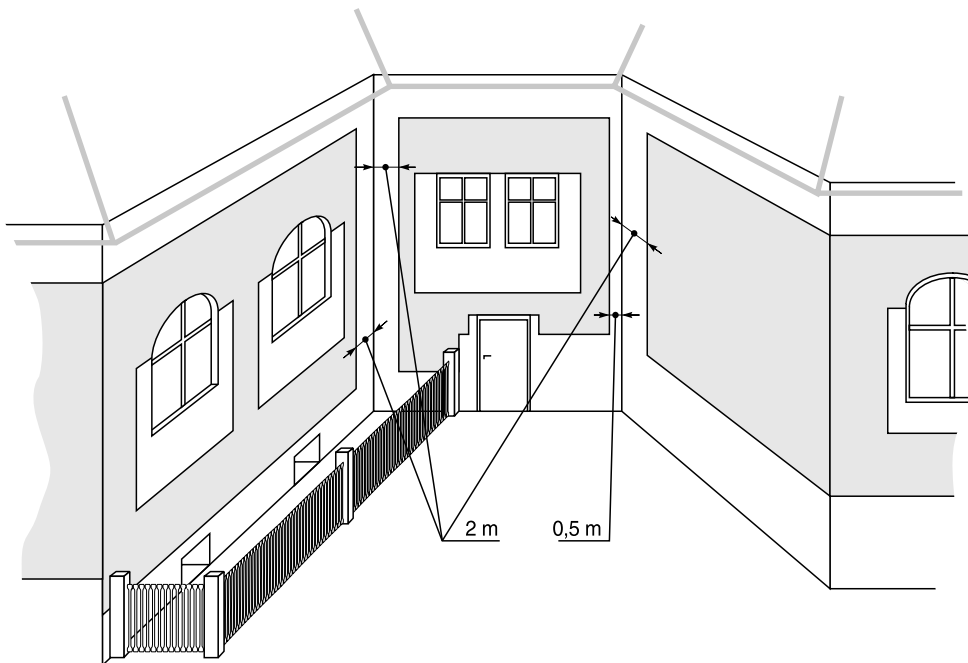

Diagram 10 - Quiet corner

HEATING SYSTEM DESIGN

Heating System Design

- The **Provitherm 23 BTVE** is compatible with any type of installation.
- Heating surfaces may consist of radiators, convectors or fan assisted convectors.
- Pipe sectional areas shall be determined in accordance with normal practices, using the output/pressure curve (**diagram1**). The distribution system shall be calculated in accordance with the output requirements of the actual system, not the maximum output of the boiler. However, provision shall be made to ensure sufficient flow so that the temperature difference between the flow and return pipes be less than or equal to 20°C. The minimum flow is 500 l/h.
- The piping system shall be routed so as to avoid any air pockets and facilitate permanent venting of the installation. Bleed fittings must be provided at every high point of the system and on all radiators.
- The total volume of water permitted for the heating system depends, amongst other things, on the static head in the cold condition. The expansion vessel on the boiler is pressurised at 0.5 bar and allows a maximum system volume of 70 litres for an average temperature of 75°C and a maximum service pressure of 3 bar. This pressure setting can be modified at commissioning stage if the static head differs. An additional expansion vessel can be fitted to the system if required.
- Provision shall be made for a drain valve at the lowest point of the system.
- Where thermostatic radiator valves are fitted, not all radiators must be fitted with this type of valve, and in particular, where the room thermostat is installed.
- In the case of an existing installation, it is **ESSENTIAL** that the system is thoroughly flushed prior to installing the new boiler, using a proprietary product such as Fenox or Sentinel. Contact the product manufacturers for specific details.

Domestic Hot Water System Design

- Copper tubing or plastic Hep20 may be used for the domestic hot water system. Unnecessary pressure losses should be avoided.
- The boiler will operate with a minimum supply pressure of 0,6 bar, but under reduced flow rate. Best operating comfort will be obtained from a supply pressure of 1 bar.

Hard Water Areas

In areas where the water is ,hard', more than 200 mg/litre, it is recommended that a proprietary scale reducer is fitted in the cold water supply to the boiler.

Safety valve discharge

WARNING. It must not discharge above an entrance or window or any type of public access area. The discharge pipe must be extended using not less than 15 mm o.d. pipe, to discharge in a visible position outside the building, facing downward preferably over a drain.

Note: Fit a compression fitting to facilitate service of the appliance.

The pipe must have a continuous fall and be routed to a position so that any discharge of water, possibly boiling or steam, cannot create any danger to persons, damage to property or external electrical components and wiring. Tighten all pipe connection joints.

Gas connection

The supply from the governed gas meter must be of adequate size to provide a constant inlet working pressure of 20 mbar.

To avoid low gas pressure problems, it is recommended that the 15 mm gas supply on the boiler is connected to using 22 mm pipe (as close as possible to the boiler within 1 metre).

- On completion, the gas installation must be tested using the pressure drop method and purged in accordance with the current issue of appropriate norm.

Sheet metal parts

WARNING: When installing or servicing this boiler, care should be taken when handling the edges of sheet metal parts to avoid the possibility of personal injury.

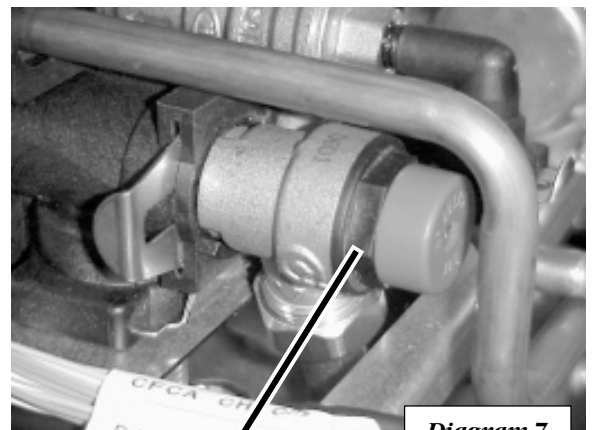

DISCHARGE
SAFETY VALVE (3 bar)

BOILER INSTALLATION

Installing the boiler

Prior to installing the boiler, the system must be thoroughly flushed to eliminate any foreign bodies and contaminants such as filings, solder, particles, oil, grease etc.

Note: Solvent products could cause damage to the system.

Flue to rear of boiler

- Mark correct position of hole from template.

Flue to side of boiler

- Mark the horizontal centre line for the hole on the rear wall. Extend the horizontal centre line to the side wall and mark the vertical centre line of flue hole as shown in **diagram 8**.

Cutting the flue hole

- Making allowance for the slope of the flue, cut hole in external wall, preferably using a core drill. For installations with internal and external access use a 105 mm diameter core drill. For installations with internal access only use a 125 mm diameter core drill.

Important

When cutting the flue hole and when extending the flue centre line to a side wall, remember that the flue system must have a fall of about 35 mm per metre of flue **DOWNWARD** towards the terminal. There must **NEVER** be a downward incline towards the boiler.

Water connection

Connect the system pipework to the copper connections on the fixing jig observing the correct flow and return format as shown in **diagram 9**. Do not subject the isolating valves to heat.

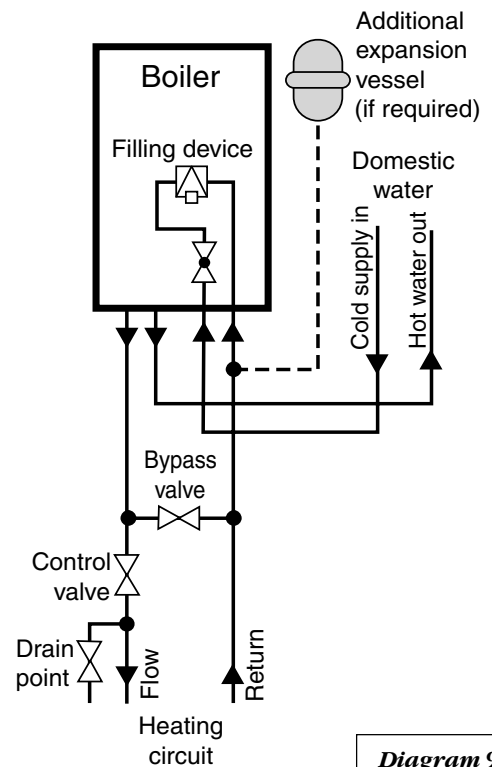

Diagram 9

HORIZONTAL FLUE INSTALLATION

- A** Air inlet pipe
- B** Terminal
- C** Seal and clamp
- D** Elbow
- E** Gasket
- F** Screws
- G** External rubber sealing collar
- I** Internal plastic collar
- J** 'O' rings

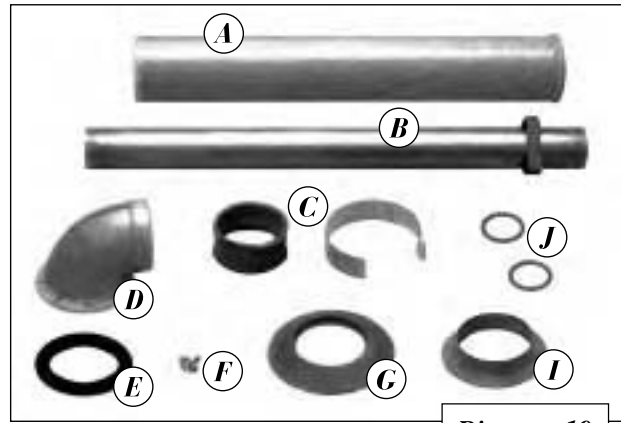

Diagram 10

- Fit gasket (**E**) onto underside of flue elbow (**D**).
- Carefully insert 'O' ring (**J**) into upper and lower parts of inner elbow.
- Fit elbow onto fan outlet.
- Fit external rubber sealing collar (**G**) onto air inlet pipe (**A**).
- Fit flue through hole in wall and pull up so that external collar (**G**) is flush against outside wall.
- Fit seal and clamp (**C**) to flue and assemble into elbow (**D**) making sure that both inner and outer pipes are sealed properly.

Note: Maximum horizontal length with no bends is 4 m. For horizontal flue lengths up to 1 m the restrictor must be left in the fan outlet, **see diagram 11**. For horizontal flue lengths between 1 and 4 m, remove the restrictor (**R**).

• Tighten up clamp using screws provided.
Note: Should it be necessary to cut the flue, always cut equal amounts from both inner and outer pipes.
 Always cut the end furthest from the terminal.

For each 90° flue bend fitted, reduce overall flue length by 1 m.
For each 45° flue bend fitted, reduce overall flue length by 1/2 m.

Diagram 11

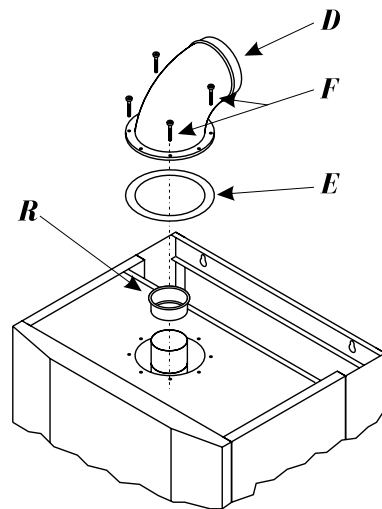
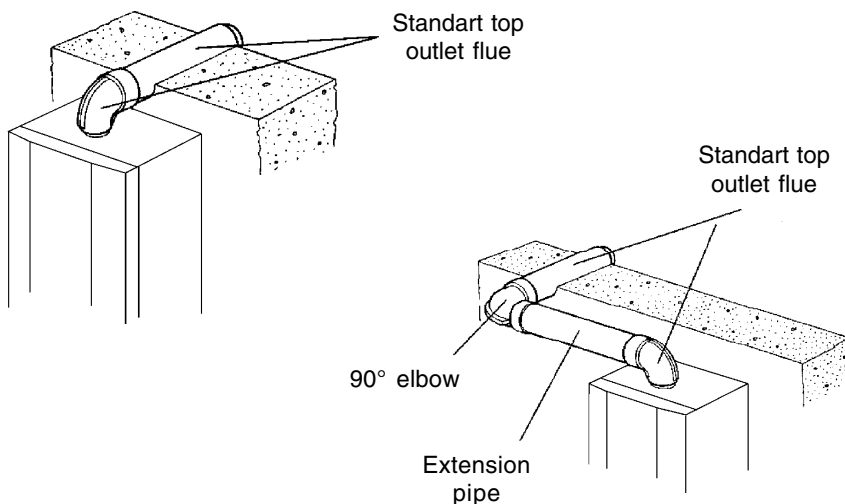

VERTICAL FLUE INSTALLATION

- Fit gasket (**E**) onto underside of vertical adaptor (**O**) – **see diagram 12**.
- Carefully insert 'O' ring (**J**) into vertical adaptor inner spigot.
- Fit vertical adaptor (**O**) onto fan outlet.
- For flat roof installation, fit flat roof flashing collar (part no. 85107)
- Fit extension pipes (**M**) as required.
- For pitch roof installation, fit pitch roof flashing (part no. 85105).
- Fit flue terminal (**L**) onto roof ensuring flashing makes a watertight joint.

Note: Maximum vertical height with no bends is 9 m.

Should it be necessary to cut the flue, always cut equal amounts from both inner and outer pipes.

Connect condensate trap (supplied) to vertical flue adaptor when flue length exceeds 3 m.

Connect 15 mm plastic pipe (not supplied) to a suitable drain.

For vertical flue lengths up to 4 m the restrictor must be left in the fan outlet, **see diagram 11**.

For vertical flue lengths between 4 and 9 m, remove the restrictor (**R**).

For each 90° flue bend fitted, reduce overall flue height by 1 m.

For each 45° flue bend fitted, reduce overall flue height by 1/2 m.

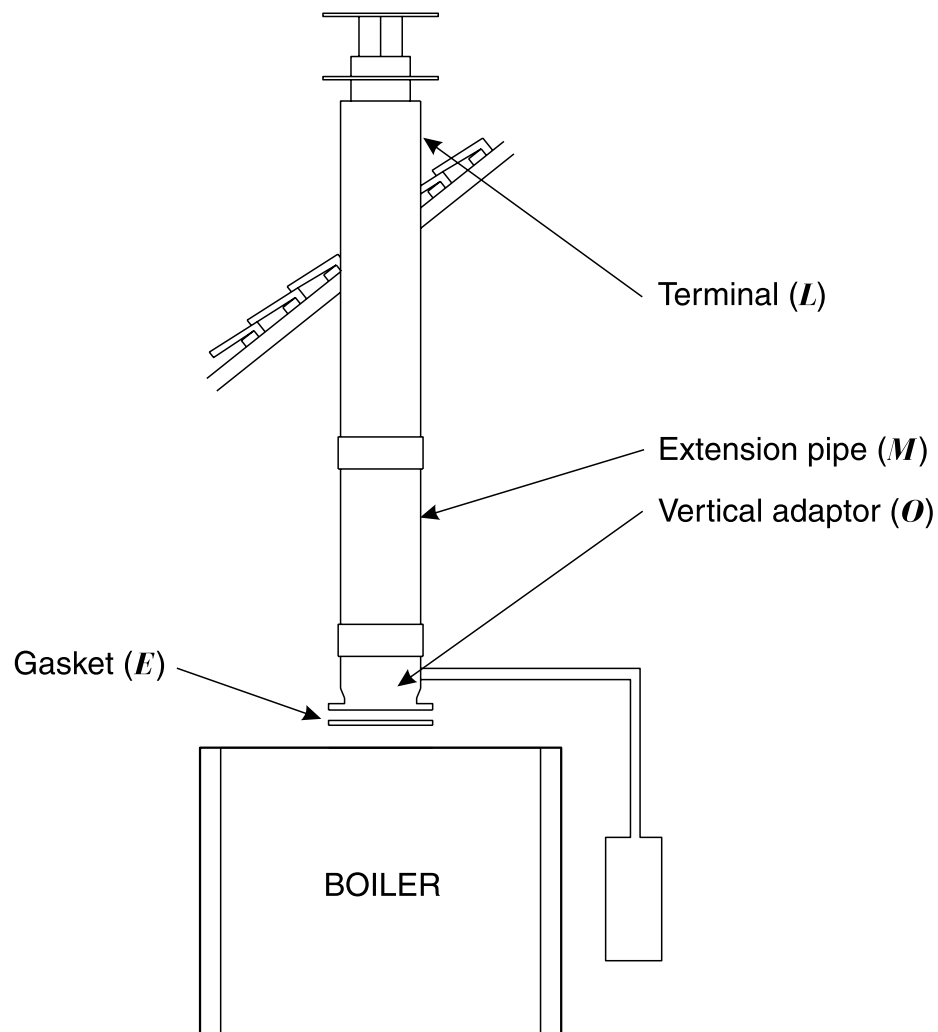
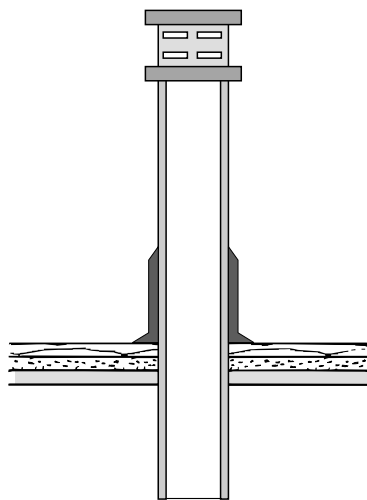
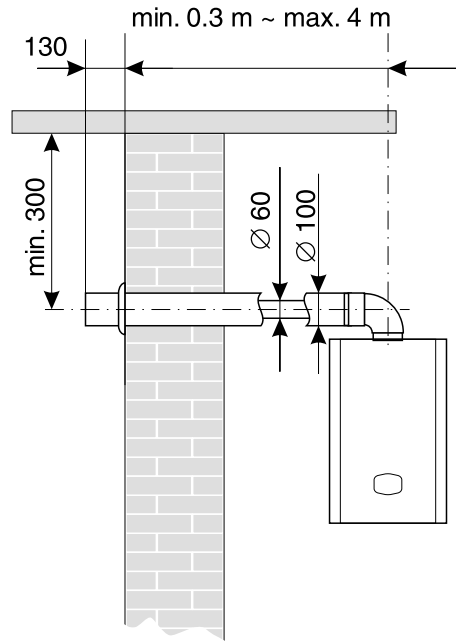
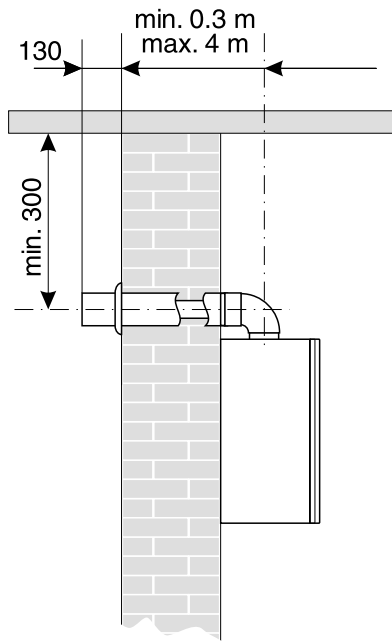
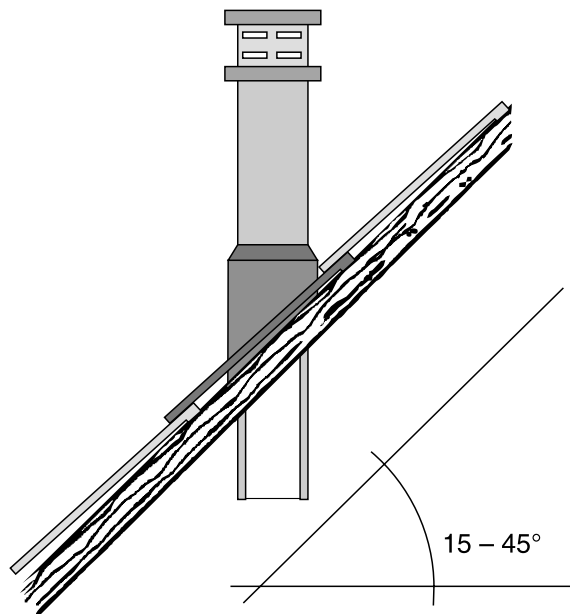

Diagram 12

FLUE CONFIGURATIONS



Flat roof which would normally require a black terminal



Pitch roof which would normally require a brick terminal

Diagram 13

ELECTRICAL PART

Warning. This boiler must be earthed

All system components must be of an approved type. Electrical components have been tested to meet the equivalent requirements.

Connection of the whole electrical system and any heating system controls to the electrical supply must be through a common isolator. Isolation should preferably be by a double pole switched fused spur box having a minimum contact separation of 3 mm on each pole. The fused spur box should be readily accessible and preferably adjacent to the boiler. It should be identified as to its use.

A fused three pin plug and shuttered socket outlet may be used instead of a fused spur box provided that both the plug and socket comply with the current issue of appropriate norm. The mains electrical supply must be maintained at all times in order to provide domestic hot water.

Do not interrupt the mains supply with a time switch or programmer.

WARNING: UNDER NO CIRCUMSTANCES MUST ANY MAINS VOLTAGE BE APPLIED TO ANY OF THE TERMINALS ON THE VOLTAGE FREE HEATING CONTROLS CONNECTION PLUG.

Warning: This appliance must be wired in accordance with these instructions. Any fault arising from incorrect wiring cannot be put right under the terms of the guarantee.

External controls - Voltage Free

This boiler will operate on heating as supplied, provided that the wire link (E) fitted between the two terminals of the heating controls connection plug is left in place, **see diagram 15.**

External controls e.g. room thermostat, frost thermostat etc. should be fitted in accordance with the rules in force.

Testing - Electrical

Checks to ensure electrical safety must be carried out by a competent person.

After installation of the system, preliminary electrical system checks as below should be carried out.

1. Test insulation resistance to earth.
2. Test earth continuity and short circuit of all cables.
3. Test the polarity of the mains. The installer is requested to advise and give guidance to the user of the controls scheme used with the boiler.

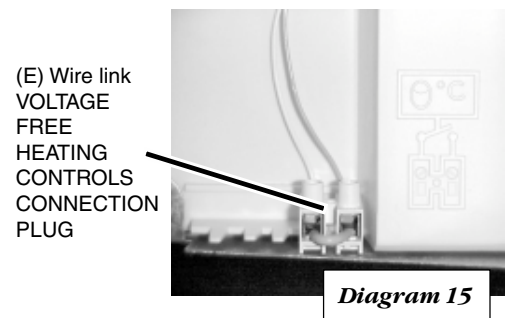

Diagram 15

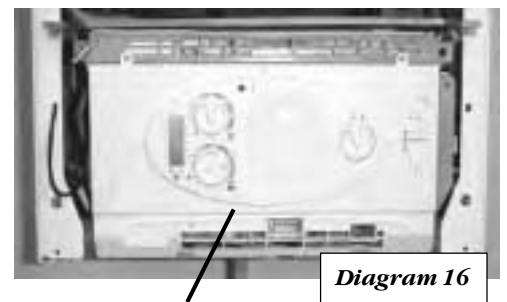

Diagram 16

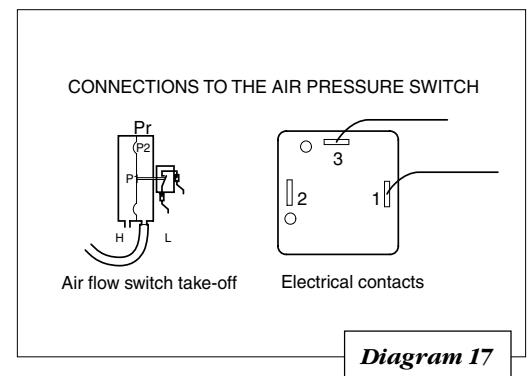

Diagram 17

COMMENCING BOILER OPERATION

The commissioning and first firing of the boiler must only be done by a qualified registered person.

Gas installation

It is recommended that any air is purged from the supply at the gas inlet test point on the gas valve, see **diagram 18**

GAS INLET
TEST POINT

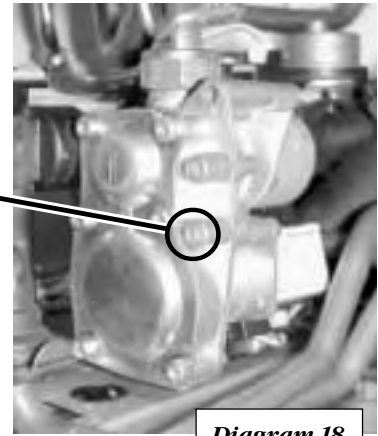
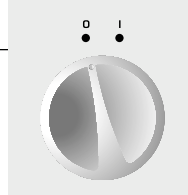

Diagram 18

Filling the system

1. Make sure that:

The boiler is connected to the electrical supply.
The gas service cock is open.
Turn the switch **OFF (0)**



2. Undo cap (**A**) on automatic air vent on top of pump and leave undone, see **diagram 19**.

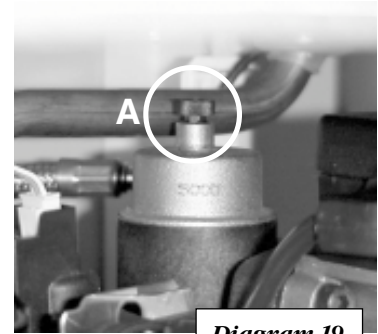
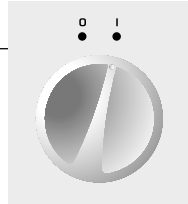

Diagram 19

3. Turn the switch **ON (I)**

Open the tap (→) on the filling device (see **diagram 20**) and fill the system until the pressure indicated on the display is 2 bar. Close filling device.



4. Bleed each radiator to remove air, ensure all bleed screws are re-tightened.
If necessary repressurise the system, refer to procedure 3.

5. Leave cap (**A**) on automatic air vent on top of pump open, see **diagram 19**.

6. Open various hot water taps to bleed system.

7. Ensure the display indicates a system pressure of 1.5 bar adjust if necessary, see **diagram 23**.

Diagram 20

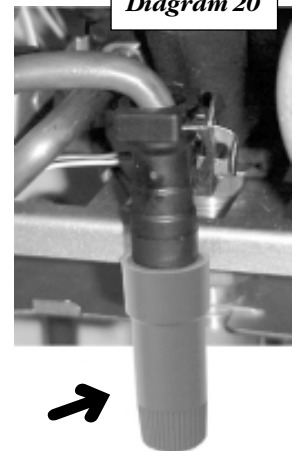
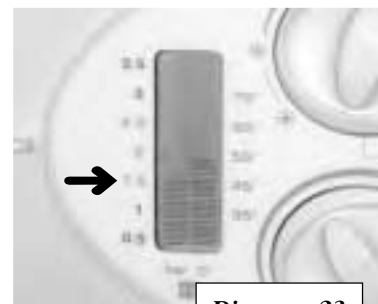

Diagram 23



Installation filling:

- **If the boiler loses water:** the pressure gauge (a) and fault display (b) will flash. Fill the system by the filling device (c) at the bottom of the boiler until the pressure gauge reads 1.5 bar (see diagram 23).

Warning: Take care not to overfill the boiler. At a pressure of 2.5 bar or above indicating over pressure, the fault display (b) will flash. The pressure must be reduced to 1.5 bar by bleeding a radiator. If the fault continues call your Installation/Service company or Heatcall.

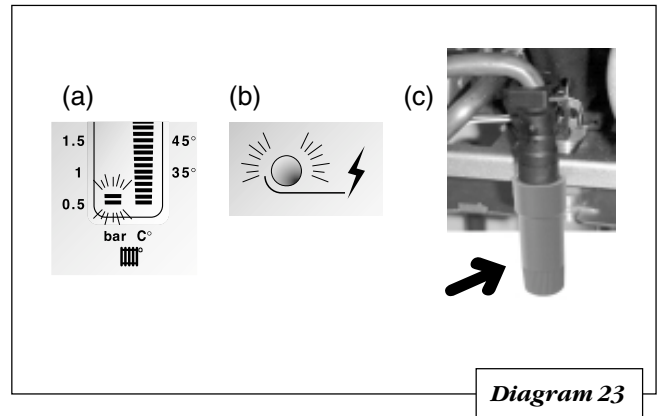

Warning: When purging the boiler, do not use the valve on the expansion vessel – it is **NOT** a purging valve!!!

- Adjust heating temperature to maximum.
- Check that any external controls, if fitted, are calling for heat (set room thermostat to maximum).
- Allow the temperature to rise to the maximum value, with all radiator valves open. The temperature rise will cause release of the gases contained in the water of the central heating system.
- Gases driven towards the boiler will be automatically released through the automatic air vent.
- The gases trapped at the highest point of the system must be released by bleeding the radiators. Check the burner gas rate required, ten minutes from lighting. Refer to Data Label on electrical controls box. Should there be any doubt about the gas rate it should be checked at the meter. On reaching maximum temperature, the boiler should be turned off and the system drained as rapidly as possible whilst still hot.
- Refill system to a pressure of between 1 and 2 bar and vent as before.
- Restart boiler and operate until a maximum temperature is reached. Shut down boiler and vent heating system. If necessary, top up heating system and make sure that a pressure of at least 1 bar is indicated when system is COLD.

Flush the domestic hot water system by opening the hot water taps for several minutes.

Boiler start

Before starting the boiler, check whether:

- The main gas valve is open;
- The gas valve on the boiler is open;
- Water valves (DHW, heating) are open;
- The boiler's cord is plugged in.

Bypass

The **Provitherm 23 BTVE** boiler has a built-in bypass. This must be adjusted according to the requirements of the system, refer to the flow rate pressure curve (diagram 1). The boiler is supplied with the built-in bypass open a half a turn. It is adjusted by turning the bypass screw (A), see diagram 24. Turn the screw clockwise to close the bypass. When using thermostatic radiator valves (TRV's) on all of the radiators, it is essential that a separate, adjustable bypass of 15 mm minimum diameter is fitted between the flow and return of the heating circuit, see diagram 8. Any bypass must be fitted before system controls.

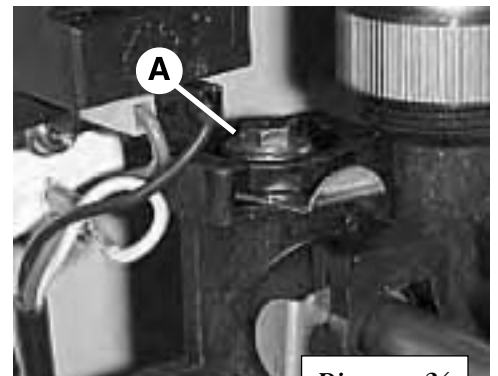

SAFETY DEVICES

The **Provitherm 23 BTVE** incorporates a visual fault display that indicates certain-fault conditions, (red flashing light, see diagram 25) should they occur. Should the boiler fail to operate during Commissioning, the most likely fault is that the gas supply to the boiler has not been turned on or purged sufficiently or that there is no pressure in the heating system.

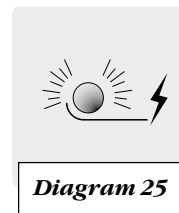

General safety devices

Air flow rate safety device

If an obstruction, even partial, of the flue occurs, for any reason whatsoever, the built in safety system of the boiler will turn the boiler OFF, the red light will flash and the fan will continue to run. The boiler will be ready to operate when the fault has been cleared.

Heating safety valve

CAUTION: A heating safety valve with a discharge pipe is fitted to this boiler. The valve **MUST NOT BE TOUCHED** except by a qualified registered person. If the valve discharges at any time, switch the boiler off and isolate it from the electrical supply. Contact your installation/service company.

In case of power supply failure

The boiler no longer operates. As soon as power supply is restored, the boiler will be automatically restarted.

If the gas supply is interrupted

The boiler switches over to safety mode, the red light will flash. Call a your installation/service company .

Air in pipes

Important: A central heating system can not operate correctly unless it is filled with water and air bled from the system. If these conditions are not met the system may be noisy. Bleed the air in the radiators and adjust the pressure if system requires. If the system requires filling to often this may be due to minor leaks or corrosion in the system. Call a qualified service engineer.

Frost protection

The **Provitherm 23 BTVE** has a built in frost protection device that protects the boiler from freezing. If the boiler is to be left and there is a risk of frost, ensure that the gas and electrical supplies are left connected. The frost protection device will light the boiler when the temperature of the boiler water falls below 4°C. When the temperature reaches 8°C, the boiler stops.

Note: This device works irrespective of any room thermostat setting and will protect the complete heating system.

SERVICING INSTRUCTIONS

To ensure the continued efficient and safe operation of the boiler, it is recommended that it is checked and serviced at regular intervals.

The frequency of servicing will depend upon the installation conditions and usage but, in general, once a year should be enough.

It is the law that any servicing is carried out by a competent person.

Heat output adjusting

If the heat output adjusted in manufacture for 15 kW don't meets You set the cursor by the trimmer P_{CH} between max and min position (23 and 8,7 kW) according to required heat output – see **diagram 26**.

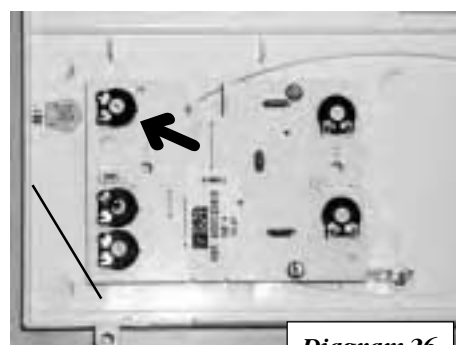

ROUTINE CLEANING AND INSPECTION

- Operate boiler and check for any faults that need to be put right.
- Isolate boiler from the gas and electrical supplies.
- On completion check all gas carrying parts for soundness with leak detection fluid.

REMEMBER, when replacing a part on this appliance, use only spare parts that you can be assured conform to the safety and performance specification that we require. Do not use reconditioned or copy parts. To ensure the continued efficient and safe operation of the boiler it is recommended that it is checked and serviced at regular intervals. The frequency of servicing will depend upon the particular installation conditions and usage, but in general once a year should be enough. It is the law that any servicing is carried out by a qualified registered person.

Service Check and Preparation.

- Isolate boiler from the gas and electrical supplies.
- Drain the Domestic hot water circuit and the boiler, refer to **diagram 30**.
- On completion check all gas-carrying parts for soundness with leak detection fluid.
- Remove boiler casing as follows:

Front panel

- Unscrew and remove the two retaining screws from the bottom of the front panel.
- Remove front panel by pulling forward and lifting up.

Control panel

- Lower forwards to gain access to lower part of boiler.

Sealed chamber cover

- Unclip the two toggle clips holding the sealed chamber cover.
- Lift cover up and off pins on the top of the boiler.

Side panels (for ease of access if required).

- Support the side panels as you remove them.
- Unscrew and remove the three retaining screws from front of each side panel.
- Left hand side panel only disconnect the control panel retaining strap at the control panel.
- Pull each panel forward from the rear retaining pins to remove.

To Drain the central heating circuit

- Open drain valve fitted at the lowest point in the system.
- Allow air into the system by opening a radiator bleed screw or the boilers drain valve **(a)**, see diagram 30.

To Drain the Domestic hot water circuit

- see diagram 30

- Close boiler isolating valve **(c)**.
- Turn on one or more hot water taps.

To Drain the boiler - see diagram 30

- Close isolating screws on the isolating valves **(b)**, **(c)** and **(d)**
turn from vertical to horizontal to close.
- Open the boiler drain valve **(a)**.
- Turn on one or more hot water taps.
- Disconnect electrical connections from thermistor.
- Remove the thermistor from the heat exchanger.
- Fit replacement thermistor.
- Refit electrical connections.
- Open the boiler drain valve **(a)**.
- Turn on one or more hot water taps. **(a)**

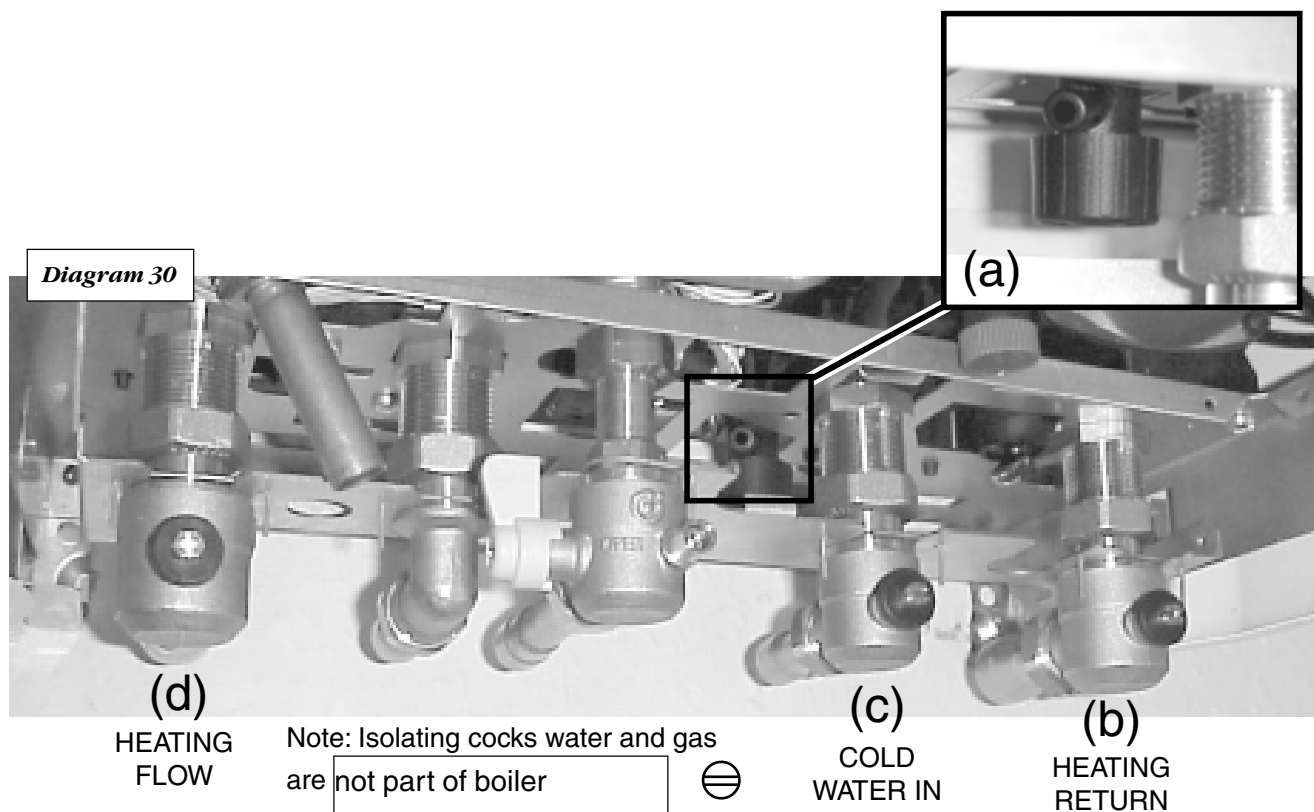

Combustion chamber cover

- Unscrew and remove the four screws securing combustion chamber cover to combustion chamber.
- Remove combustion chamber cover from boiler.
- Take care not to damage the insulation.

Spark and Sense Gaps

- Check that the spark and sense gaps as shown in **diagram 32**.

Note: To gain access to spark and sense electrodes for removal, refer to **Section Replacement of Parts**.

Burner, refer to diagram 33.

- Unscrew and remove the two burner retaining screws.
- Remove burner from boiler by easing it forward off the two burner guides.
- Clean burner by washing in soapy water. Dry thoroughly before refitting.

Note: To gain access to injectors for removal and cleaning, refer to **Section Replacement of Parts**.

Fan, refer to diagram 34.

- Disconnect power supply leads and earth lead from fan.
- Remove air pressure switch sensing tube from the side of the fan.
- Unscrew and remove the fan retaining screw.
- Ease the fan down and forwards to remove.

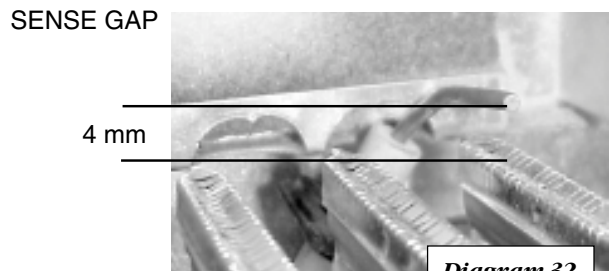
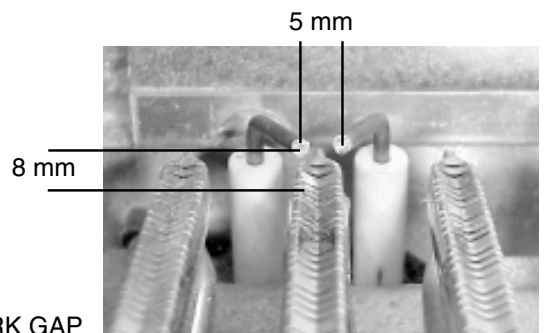
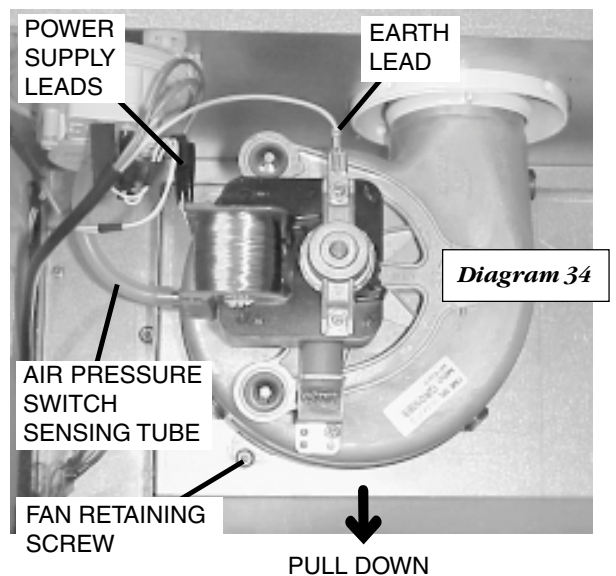
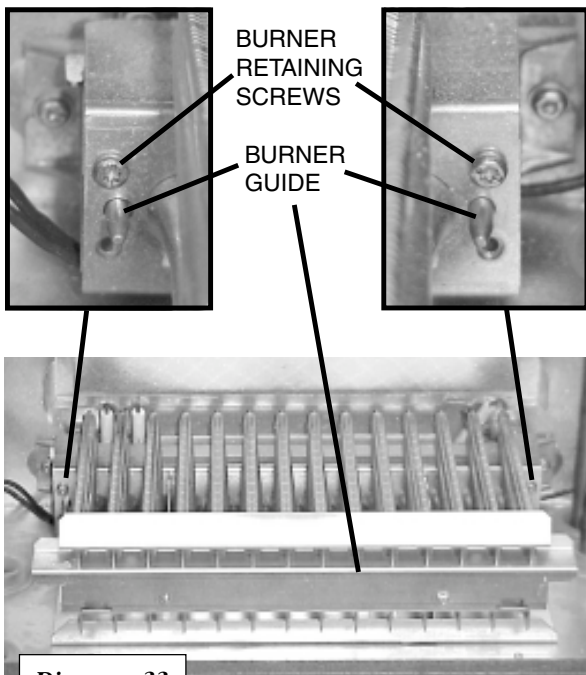

Diagram 32



Heat exchanger.

- Remove the two flue hood retaining screws to remove the flue hood.
- Use a soft brush or vacuum clean the heat exchanger.

DO NOT USE ANY TOOL LIKELY TO DAMAGE PAINTED FINISH OF HEAT EXCHANGER.

Domestic water inlet filter, refer to diagram 36.

If the water flow rate through the appliance has reduced it may be necessary to clean or replace the domestic water inlet filter.

- Pull out slotted clip securing the filter in its housing, remove the filter to clean or renew if necessary. Replace the filter into its housing and replace the securing clip.
- Open isolating valve (c) on cold water inlet and test the Domestic Hot Water circuit for soundness.

Central Heating Filter, refer to diagram 37.

Remove the filter retaining clip and filter clean or renew if necessary. Refit the filter, ensuring the correct orientation. The flat and hole in the filter as shown. Secure with retaining clip.

Reassembly of parts removed for servicing

All parts are replaced in reverse order to removal.

Flue system

- Check externally to make sure that flue is not blocked
- Inspect flue system to make sure that all fittings are secure.

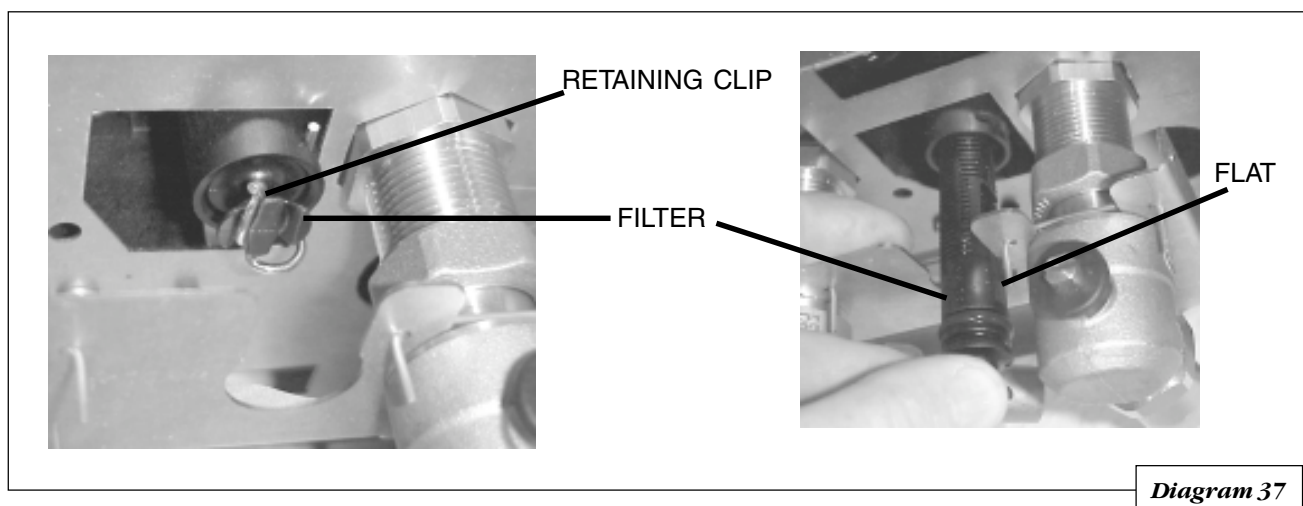
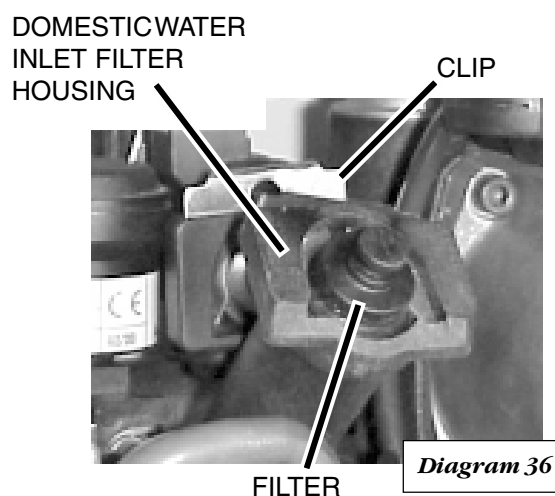

REPLACEMENT OF PARTS

IMPORTANT INFORMATION

WARNING: Before commencing the replacement of any component, isolate appliance from electrical supply and turn off gas at service cock. Replacement of parts must be carried out by a competent person. When replacing components it may be necessary to renew sealing washers, gaskets and ,O' rings. If new ones are supplied with replacement components they must be used. All parts are replaced in reverse order to removal. If any gas-carrying components are disturbed, removed or replaced it will be necessary on completion to check for gas soundness with leak detection fluid.

Central heating thermistor

Before starting refer to the front of **Section Important information.**

- Remove the front panel.
- Lower the control panel.
- Remove the sealed chamber cover.
- Locate central heating thermistor on the top left hand side of the heat exchanger, **see diagram 38.**

Fan - refer to section "Routine cleaning and inspection"

Important: Ensure that fan outlet is correctly fitted into flue elbow at top of boiler.

Air pressure switch

Before starting refer to the front of **Section Important information.**

- Remove the front panel.
- Lower the control panel.
- Remove the sealed chamber cover.
- Locate air pressure switch situated inside combustion chamber on top left hand side, **see diagram 39.**
- Remove air pressure switch tube from sensing probe on fan.
- Disconnect air pressure switch electrical connections.
- Unclip to remove air pressure switch.

Domestic water inlet filter

Before starting refer to the front of **Section Important information.** If the water flow rate through the appliance has reduced it may be necessary to clean or replace the water inlet filter, **refer to Section Routine cleaning and inspection.**

Central Heating Filter

Before starting refer to the front of **Section Important information.**

It may be necessary to clean or replace the central heating filter, **refer to section Routine cleaning and inspection.**

CENTRAL HEATING THERMISTOR

OVERHEAT THERMOSTAT

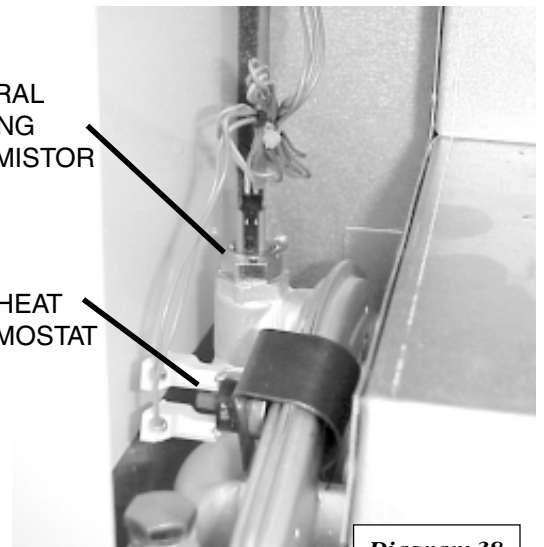

Diagram 38

RETAINING CLIPS

AIR PRESSURE SWITCH

ELECTRICAL CONNECTORS

SENSING TUBE

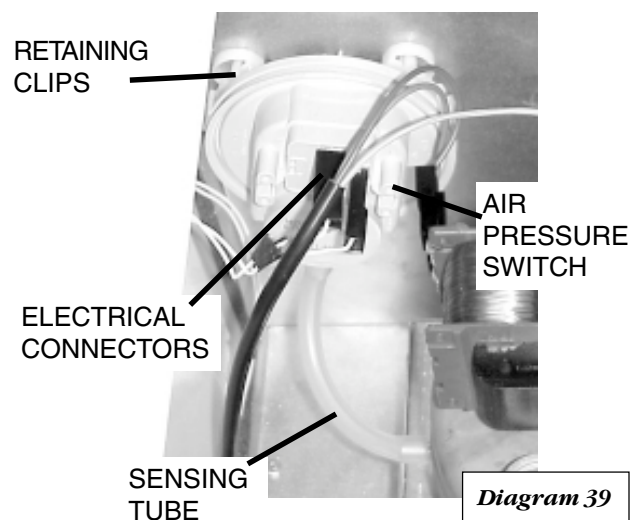

Diagram 39

Burner, refer to Section Routine cleaning and inspection.

Before starting refer to the front of **Section Important information.**

Burner injectors, refer to diagram 40.

Before starting refer to the front of **Section Important information.**

- Remove burner from boiler.
- Remove and replace injectors as required.

Note: The injectors may be cleaned, remove injectors inspect and clean. **Do not use a wire or sharp instrument.**

Note: Make sure that injector size, marked on each injector, is the same as that given in '**Section Technical Data**' for the type of gas being used.

Burner injector assembly, refer to diagram 41.

Before starting refer to the front of **Section Important information.**

- Remove burner from boiler.
- Undo the gas supply union nut from under the sealed chamber.

Note: The fibre washer between the burner injector assembly and gas supply must be kept for use on reassembly.

- Undo and remove the sense and ignition electrode assemblies.
- Remove the burner injector assembly securing screws.
- Remove the burner injector assembly by lifting up, easing the gas connection through the grommet in the sealing chamber.
- When refitting burner injector assembly ensure the gas connection locates correctly through the grommet.

Note: Make sure that injector size, marked on each injector, is the same as that given in '**Section Technical Data**' for the type of gas being used.

Domestic hot water thermistor

Before starting refer to the front of **Section Important information.**

- Remove the front panel.
- Lower the control panel.
- Locate domestic hot water thermistor on domestic hot water pipe to the left of centre of the boiler, **see part of diagram 42.**
- Disconnect electrical connections from thermostat
- Unclip thermostat from flow pipe to the heat exchanger.
- When refitting electrical connections to replacement thermostat the polarity is not important.

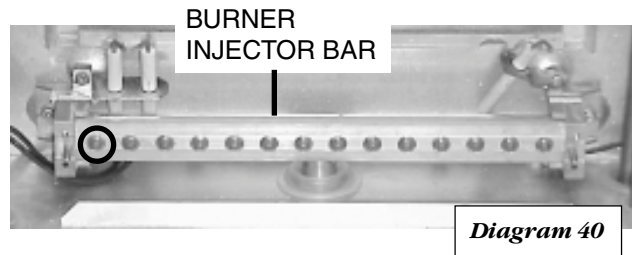

Diagram 40

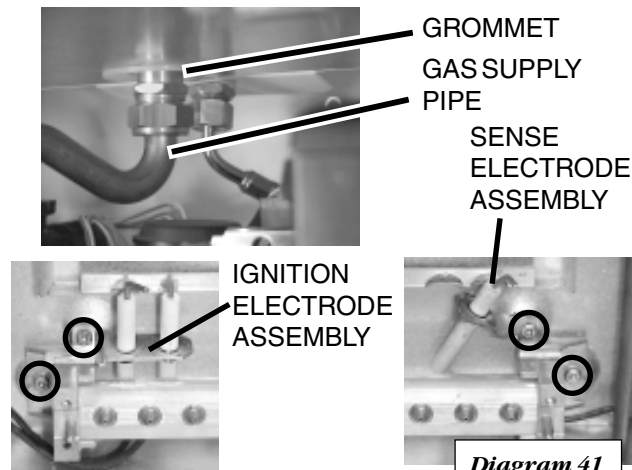

Diagram 41

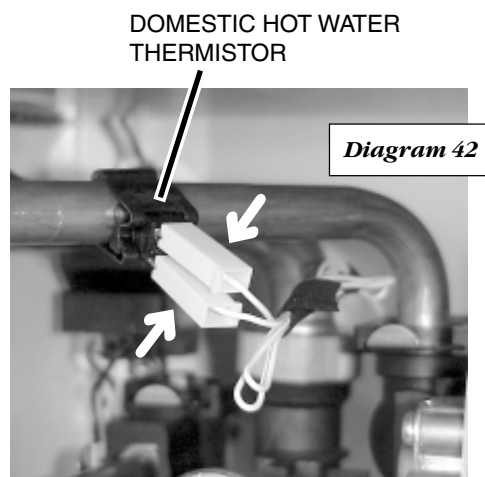

Diagram 42

Overheat thermostat

Before starting refer to the front of **Section Important information**.

- Remove the front panel.
- Lower the control panel.
- Remove the sealed chamber cover.
- Locate overheat thermostat on left hand side of heat exchanger, **see part of diagram 43**.
- Disconnect electrical connections from thermostat
- Unclip thermostat from heat exchanger.
- When refitting electrical connections to replacement thermostat the polarity is not important.

Ignition electrode

Before starting refer to the front of **Section Important information**.

- Remove burner.
- Remove the left hand side panel.
- Undo and remove screw securing electrode assembly to the burner injector assembly, **see diagram 41**.
- Disconnect the electrical connections at the igniter unit, **see diagram 57**. Note the routing of the cables.

Flame sense electrode

Before starting refer to the front of **Section Important information**.

- Remove burner.
- Remove the right hand side panel.
- Undo and remove screw securing sense assembly to the burner injector assembly, **see diagram 41**.
- Disconnect the electrical connection from the inline connector. Note the routing of the cable.

Heat exchanger, refer to diagram 43.

Before starting refer to the front of **Section Important information**.

- Remove the front panel.
- Lower the control panel.
- Remove the sealed chamber cover.
- Remove the combustion chamber cover.
- Drain down central heating water circuit and domestic hot water circuit of the boiler only.
- Remove the fan.

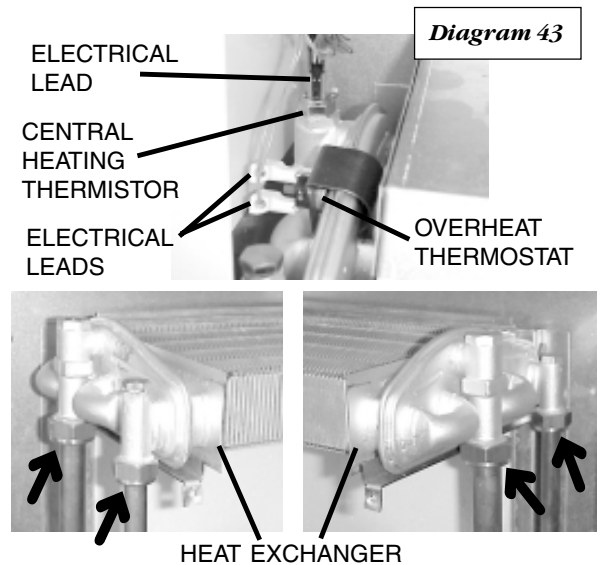

- Remove the flue hood, retained by two screws lift up and off.
- Remove the electrical leads from the overheat thermostat, **refer to diagram 43.**
- Disconnect the four union nuts.
- Lift to remove the heat exchanger taking, care not to damage the insulation.

Printed circuit board (PCB), refer to diagram 45.

Before starting refer to the front of **Section Important information.**

- Remove the front panel.
- Lower the control panel.
- Gain access to rear of control panel.
- Undo and remove the two cover retaining screws. This will disconnect the metal plate heat reflector.
- Hinge up the control panel cover and ease forwards from the rear retaining lugs to gain access to PCB. Do not strain the cables attached to the PCB. Note the routing of the cables.
- Carefully pull off electrical connections to PCB.
- Unclip and lift out PCB.
- Fit replacement PCB in reverse order to removal. Be careful not to trap any of the cables. Make sure that PCB connections are fully pushed onto replacement PCB.

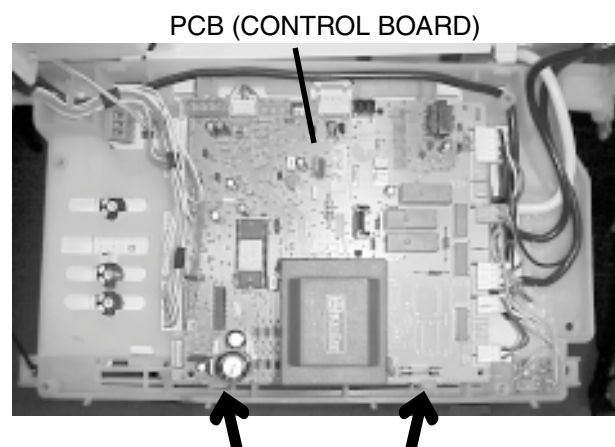
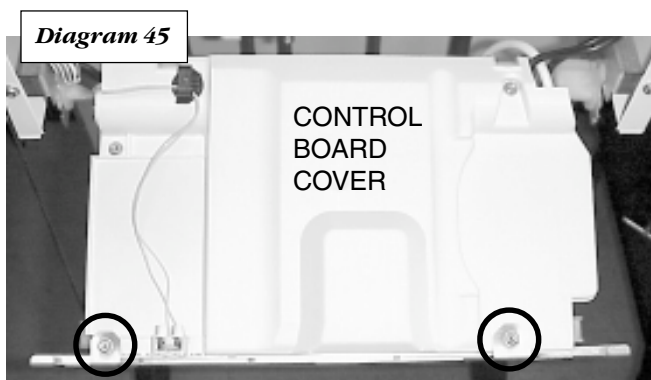
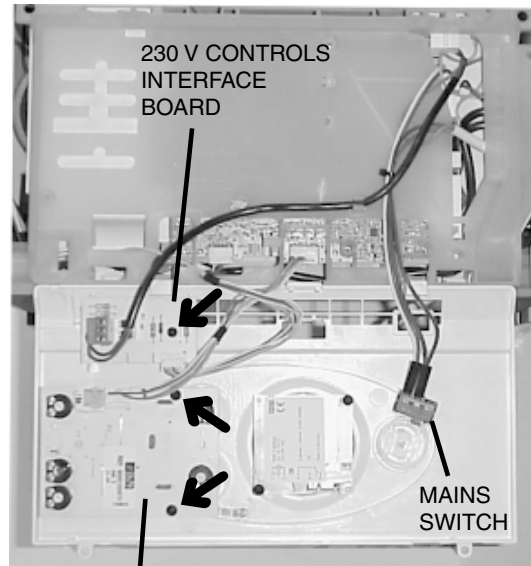

Diagram 46



CONTROL PANEL



USER INTERFACE BOARD

User interface board, refer to diagram 46.

Before starting refer to the front of **Section Important information.**

- Remove the front panel, **refer to Section Routine cleaning and inspection.**
- Lower the control panel, **refer to Section Routine cleaning and inspection.**
- Unclip control panel user interface and hinge forward . Do not strain the cables.
- Disconnect the electrical connections from the user inter face board.
- Remove the two user inter face board retaining screws.
- Remove the user inter face board.

Mains switch, see diagram 46.

Before starting refer to the front of **Section Important information.**

- Remove the front panel, **refer to Section Routine cleaning and inspection.**
- Lower the control panel, **refer to Section Routine cleaning and inspection.**
- Unclip control panel user interface and hinge forward . Do not strain the cables.
- Disconnect the electrical connections from the mains switch.
- Remove and replace the mains switch.

Central heating pump head, refer to diagram 47.

Before starting refer to the front of **Section Important information.**

- Remove the front panel.
- Lower the control panel.
- Drain down central heating water circuit of the boiler only.

Note: it is not necessary to drain down the entire heating system to carry out this work.

- For ease of access if required remove the right hand side panel.
- Undo four fixing screws and remove pump head.
- Gain access to the pump electrical connection box and remove cover.

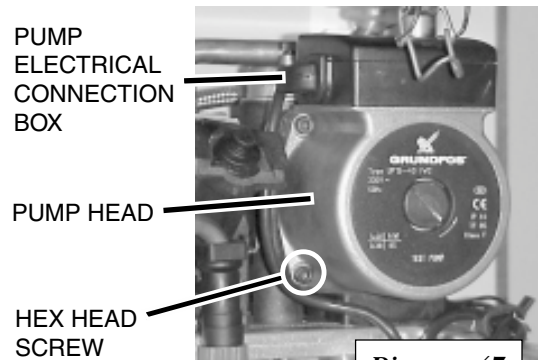

Diagram 47

- Disconnect pump cable from pump (avoid straining cables).
- Connect electrical connection to replacement pump head.
- Fit replacement pump head in reverse order to removal.
- Check for leaks.

Filling system tap, refer to diagram 48.

Before starting refer to the front of **Section Important information.**

- Remove the front panel.
- Lower the control panel.
- Drain down the boiler only.
- Pull out slotted metal clip securing tap into housing, remove tap.
- Pull out slotted metal clip and remove pipe from tap.

Reduced pressure zone valve (RPZ), refer to diagram 48.

Before starting refer to the front of **Section Important information.**

- Remove the front panel.
- Lower the control panel.
- Drain down the boiler only.
- Pull out slotted metal clip securing pipe to RPZ.
- Pull out slotted metal clip securing RPZ into housing, remove RPZ.

Boiler drain point, refer to diagram 49.

Before starting refer to the front of **Section Important information.**

- Remove the front panel.
 - Lower the control panel.
 - Drain down the boiler only.
- Pull out slotted metal clip securing boiler drain valve into housing, remove boiler drain valve.

Water flow sensor, refer to diagram 50.

Before starting refer to the front of **Section Important information.**

- Remove the front panel, **refer to Section Routine cleaning and inspection.**
- Lower the control panel, **refer to Section Routine cleaning and inspection.**
- Drain down the boiler.
- Undo the union on the cold water inlet isolating tap.
- Pull out slotted metal clip securing filling system tap into housing, swing the tap forwards.
- Pull out the two slotted metal clips retaining the domestic water inlet filter housing.
- Remove domestic water inlet filter housing.
- Remove electrical connections from water flow sensor.
- Pull off slotted metal clip and remove water flow sensor.

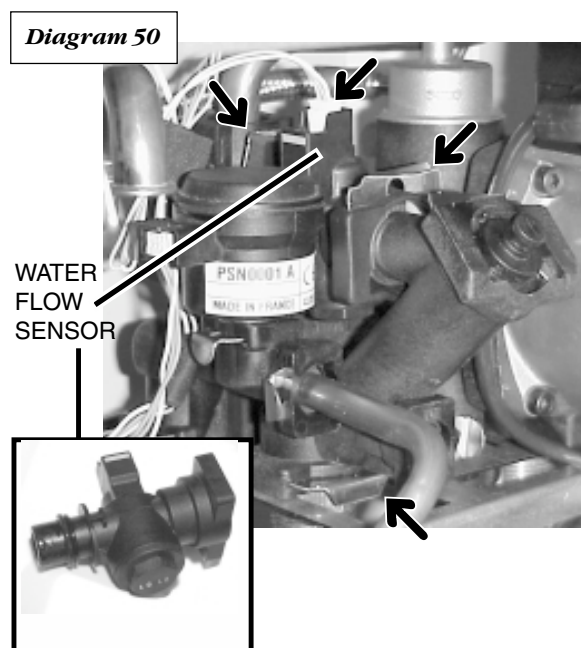
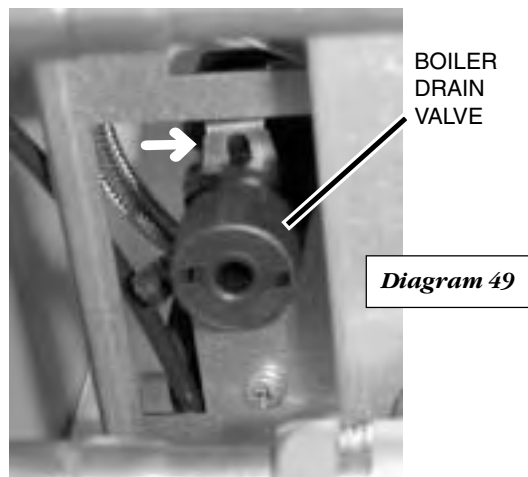
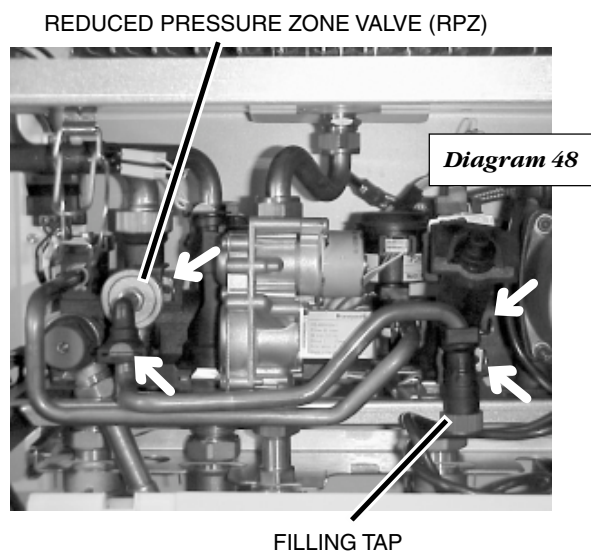

System water pressure sensor, refer to diagram 51.

Before starting refer to the front of **Section Important information.**

- Remove the front panel, refer to **Section Routine cleaning and inspection.**
- Lower the control panel, refer to **Section Routine cleaning and inspection.**
- Drain down the boiler.
- Remove electrical connections from water pressure sensor.
- Pull off slotted metal clip and remove water pressure sensor.

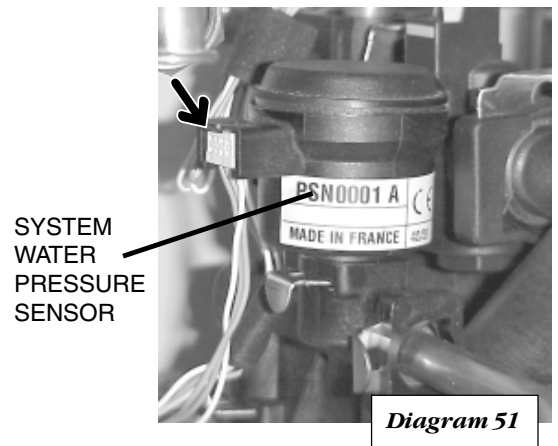

Bypass valve, refer to diagram 52.

Before starting refer to the front of **Section Important information.**

- Remove the front panel.
- Lower the control panel.
- Drain down the boiler.
- Pull out slotted metal clip and remove bypass valve.

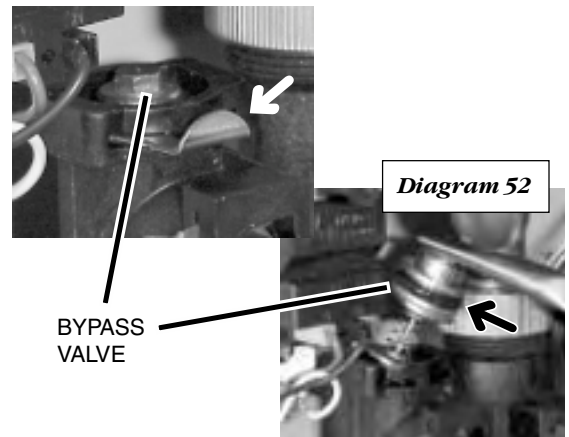

Automatic air vent, refer to diagram 53.

Before starting refer to the front of **Section Important information.**

- Remove the front panel.
- Lower the control panel.
- Drain down the boiler only.
- Unscrew to remove automatic air vent.
- After fitting replacement automatic air vent ensure the cap is open.

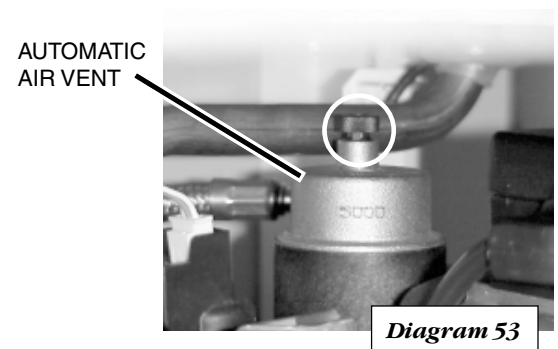

Gas Control valve, refer to diagram 54.

Before starting refer to the front of **Section Important information.**

- Remove the front panel.
- Lower the control panel.
- Disconnect gas supply pipe union nuts at the gas control valve.
- Disconnect injector supply pipe union nut at the gas control valve. Slacken the union nut at the burner injector bar.
- Remove gas control valve retaining clip from the underside of gas control valve.
- Ease gas control valve forwards and disconnect electrical connections to gas control valve.

Note: The washers must be kept for use on reassembly.

- Withdraw gas control valve assembly.
- After fitting replacement gas control valve test for gas soundness.

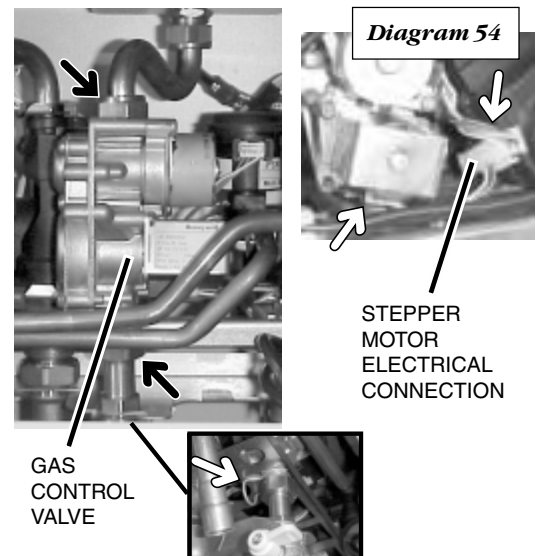

Gas control valve stepper motor

Before starting refer to the front of **Section Important information**.

- Remove the front panel.
- Lower the control panel.
- Disconnect the electrical connection from stepper motor, **see diagram 54**.
- Remove the two screws securing stepper motor to the gas control valve, **see diagram 55**.
- Fit replacement gas control valve stepper motor.
- Note: Take care not to damage the ,O' ring.

Igniter unit, refer to diagram 56.

Before starting refer to the front of **Section Important information**.

- Remove the front panel.
- Lower the control panel.
- For ease of access remove the left hand side panel, **refer to Section Routine cleaning and inspection**.
- Disconnect electrical connections.
- Remove ignition unit securing screw.
- Pull upwards to release and remove the ignition unit from the retaining slot.

Discharge safety valve, refer to diagram 57.

Before starting refer to the front of **Section Important information**.

- Remove the front panel
- Lower the control panel.
- Undo discharge pipe union nut.
- Pull out slotted metal clip from valve body and remove valve.

Diagram 55

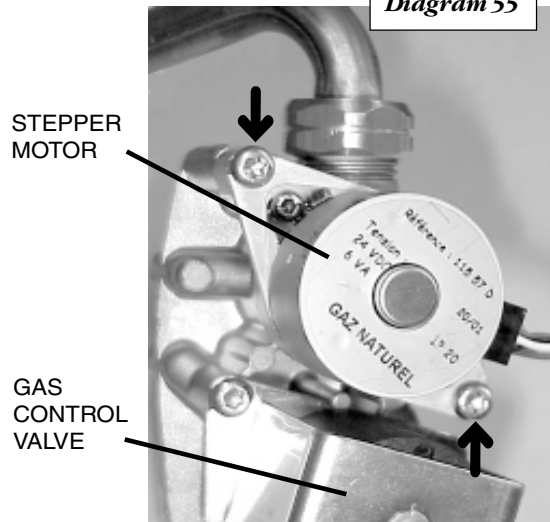

Diagram 56

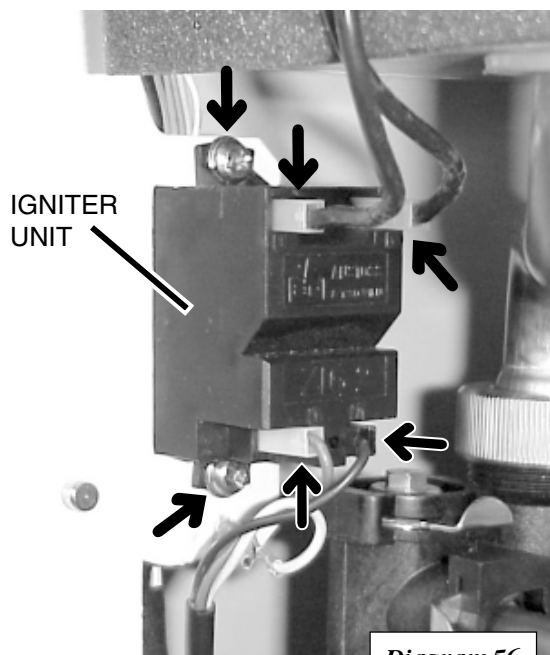
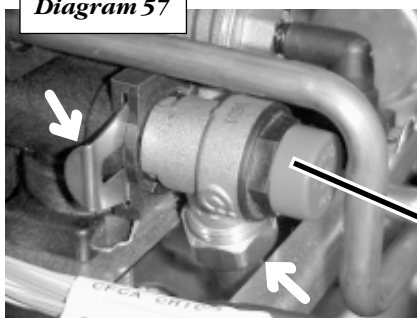
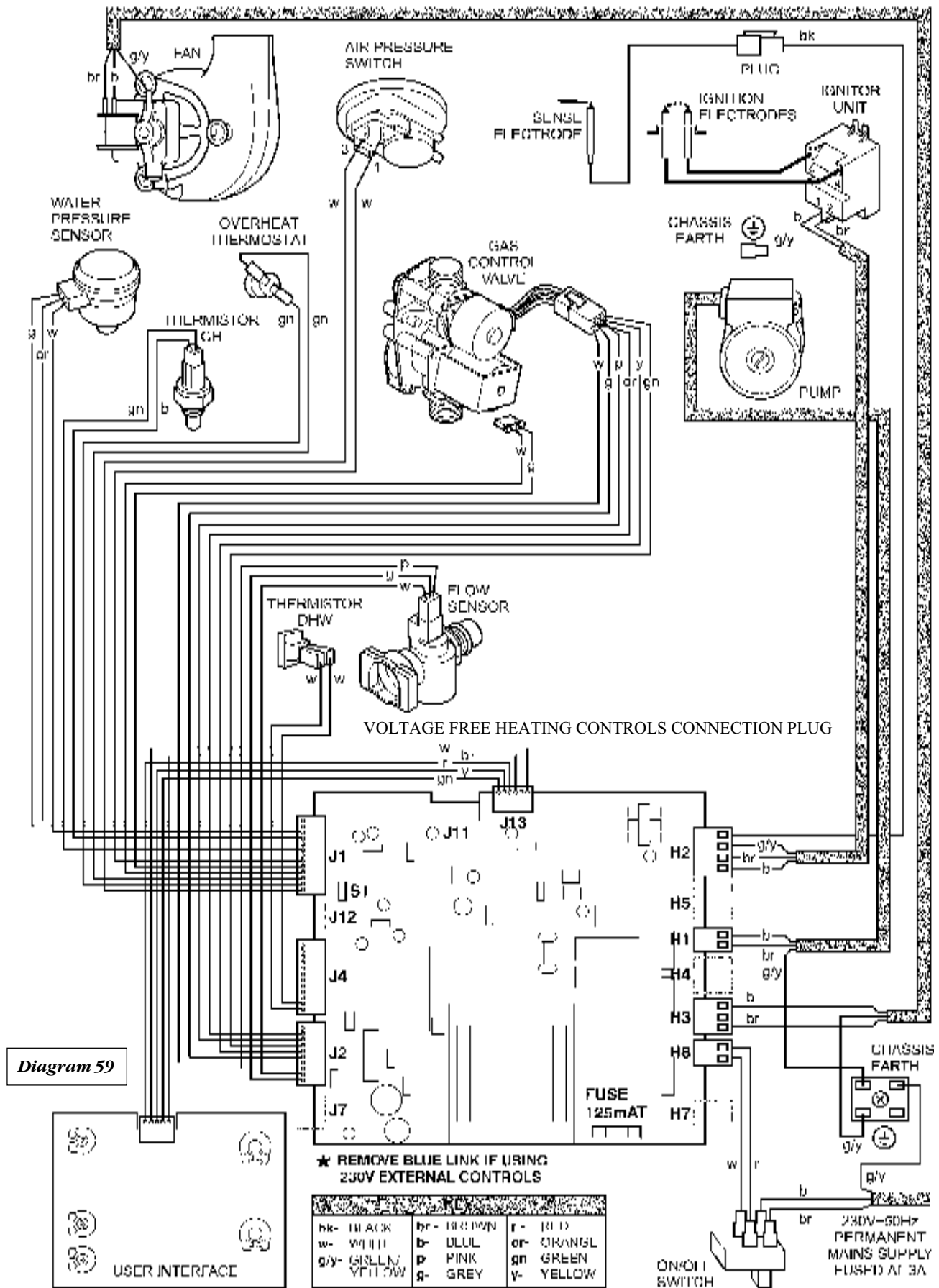

Diagram 57



DISCHARGE SAFETY VALVE

PROVITHERM 23 BTVE - Electrical diagram



DEFECTS

Before trying to operate the boiler make sure that:

- All gas supply cocks are open and that the gas supply has been purged of air.
- The heating system pressure is at least 1 bar.
- There is a permanent mains supply to the boiler.
- The fuse on the PCB is intact.

WARNING. Always isolate the boiler from the electrical supply before carrying out any electrical replacement work. Always check for gas soundness after any service work. Should there be any doubt about the voltage supply to any of the components, it is possible to carry out a simple electrical test to ensure all is operational in that area. To carry out the electrical test, gain access to the main Printed Circuit Board (PCB), as described previously, and measure the voltages according to table 2.

IMPORTANT: On completion of the fault finding task which has required the breaking or remaking of the electrical connections, the continuity, polarity, short circuit and resistance to earth checks must be repeated using a suitable multimeter.

Table 2

Voltage	Measured value	Measuring point
230 Volt	230 V AC	Between terminals H8.1 and H8.2
24 Volt	maximum 33 V DC minimum 20 V DC	Between terminals J5.3 and J15.1
18 Volt	18 V ± 1 V	Between terminals J2.9 and J2.10
Display 5 V	± 0.5 V	Between terminals J13.4 and J13.1

The electrical resistance of the thermal sensors corresponds to temperature changes as follows:

- 15 °C..... 16 kΩ
- 20 °C..... 12.7 kΩ
- 25 °C..... 10 kΩ

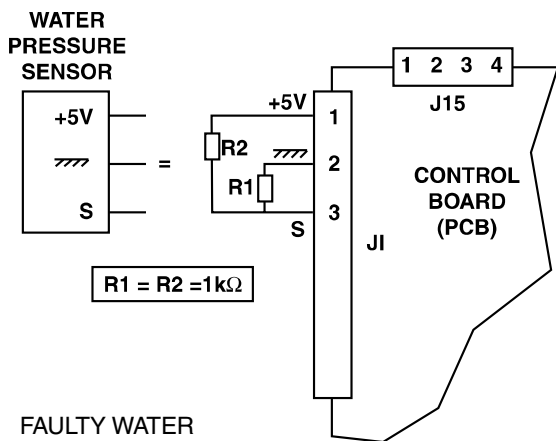

FAULTY WATER PRESSURE SENSOR
It is possible to replace the sensor with two 1kΩ resistors as shown in the diagram.

Diagram 60

Overheat thermostat reset button.

Refer to section 18.10 to locate the overheat thermostat reset button.

Depress the button to reset.

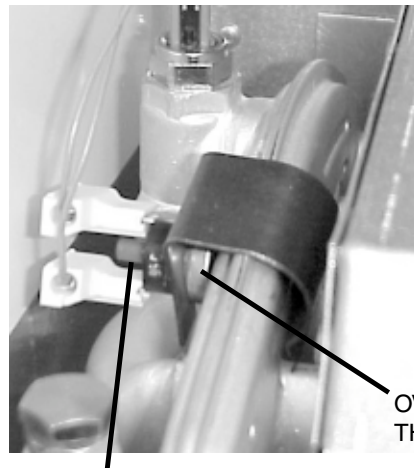

RESET BUTTON

OVERHEAT THERMOSTAT

Diagram 61

TYPE OF FAULT	CHECK
No domestic hot water or central heating (No flashing warning light on control panel)	<ul style="list-style-type: none"> • 230V supply • Is fuse blown • Loose connections on control board (PCB) • Faulty control or interface board (PCB's)
No domestic hot water or central heating (A flashing warning light on control panel)	<ul style="list-style-type: none"> • Water pressure • Shortage of air or gas • Faulty temperature sensor • Overheating • Wrong flue length • Connections on air pressure switch (electrical or tubes) disconnected
No hot water but central heating ok	<ul style="list-style-type: none"> • Loose connections at hot water flow sensor. • Faulty hot water flow sensor. • Faulty control board (PCB).

COMPONENT	NORMAL	MEASURE CHECK
Gas control valve Resistance of coil 116 Ω	<p><i>Under demand during ignition sparks:</i> 24V dc for 1 to 2 seconds, then 12Vdc (constant) at the gas control valve electrical connection.</p>	<p><i>If 0 Volt:</i> the gas control valve is not faulty. <i>If 24 Volts and then 12 Volts but no gas at the burner:</i> Check if the gas control valve is stuck. If not, check the stepper valve.</p>
Adjustment valve (step motor)	<p><i>Close the gas inlet:</i> Dismantle the step motor (screw not sealed in). Trigger a demand and check that the valve opens during the ignition.</p>	<p>If the valve does not move: Check the connections at both motor and control board (PCB). Change the motor. Replace the control board (PCB).</p>
Domestic water flow		<p><i>To test:</i> Use a new detector and connect it electrically in place of the faulty one. Blow through to simulate a demand for water.</p>