



# AIR CONDITIONER SPLIT TYPE

SERVICE MANUAL

***X-FRIZZY***

RS-B07A/RU-B07A  
RS-B09A/RU-B09A  
RS-B12A/RU-B12A

## **CONTENTS**

## **PAGE**

<b>PRODUCT SPECIFICATIONS</b>	<b>3</b>
<b>REFRIGERATION DIAGRAM</b>	<b>7</b>
<b>INTRODUCTIONS OF INSTALLATION</b>	<b>8</b>
<b>REMOTE CONTROLLER INTRODUCTIONS</b>	<b>14</b>
<b>BRIEF INTRODUCTION FOR USAGE</b>	<b>22</b>
<b>WIRING DIAGRAM</b>	<b>31</b>
<b>DISASSEMBLY &amp; ASSEMBLY</b>	<b>33</b>
<b>TROUBLESHOOTING GUIDE</b>	<b>37</b>
<b>EXPLODED VIEWS &amp; PARTS LIST</b>	<b>46</b>
<b>OPERATION DETAILS</b>	<b>50</b>
<b>CURRENT &amp; WIRING DIAGRAM OF PCB</b>	<b>58</b>

## *Chapter 1 Product Specification*

### *1.1 Photo of Product*

#### ***Indoor Unit***



#### ***Outdoor Unit***

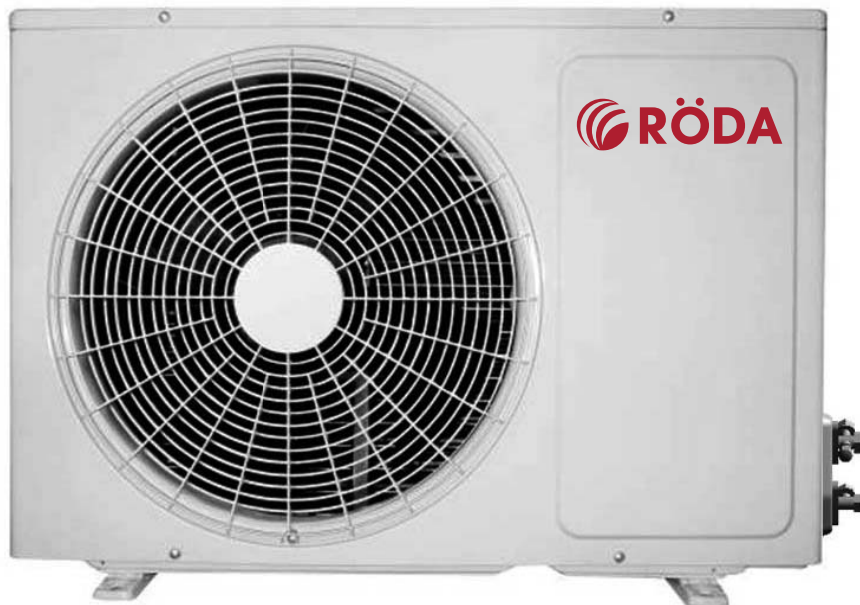

## 1.2 Outline Dimensions

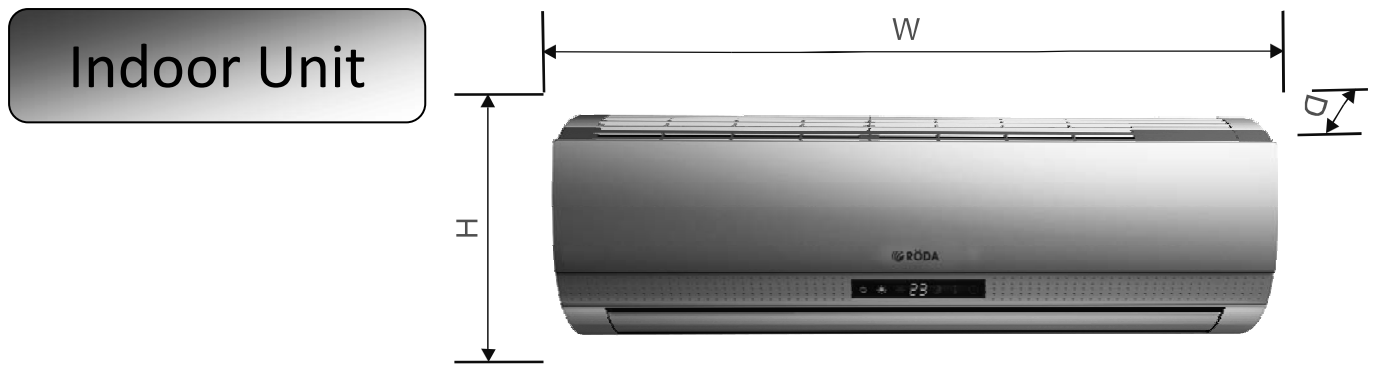

MODEL		7000 BTU	9000 BTU	12000 BTU
<b>W</b>	mm	802	802	802
<b>D</b>	mm	265	265	265
<b>H</b>	mm	190	190	190

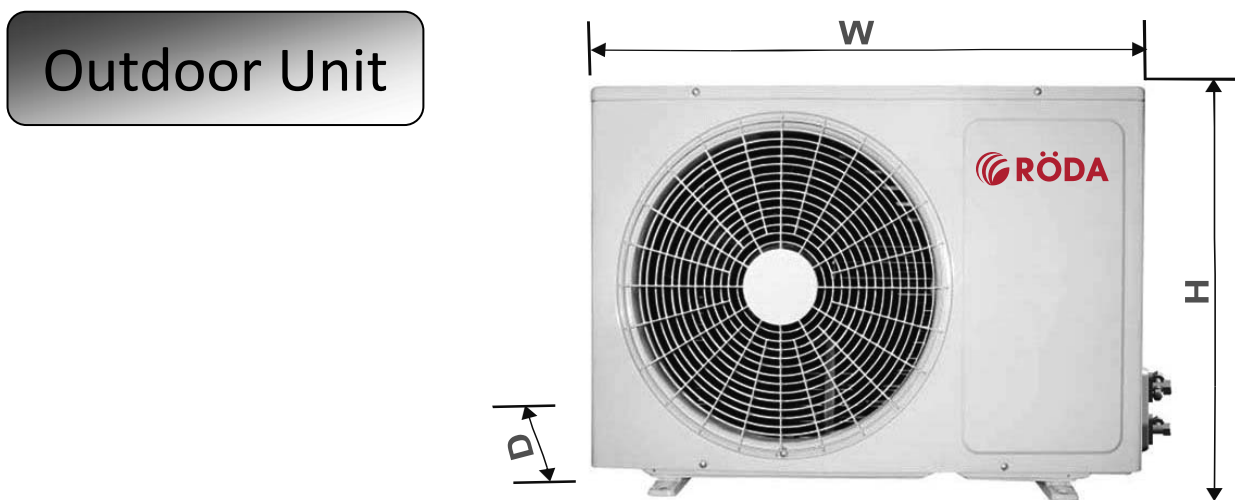

MODEL		7000 BTU	9000 BTU	12000 BTU
<b>W</b>	mm	600	700	760
<b>D</b>	mm	250	225	260
<b>H</b>	mm	490	500	540

# Chapter 2 Refrigeration Diagrams

## 2.1 Cooling Only

### Cooling Mode

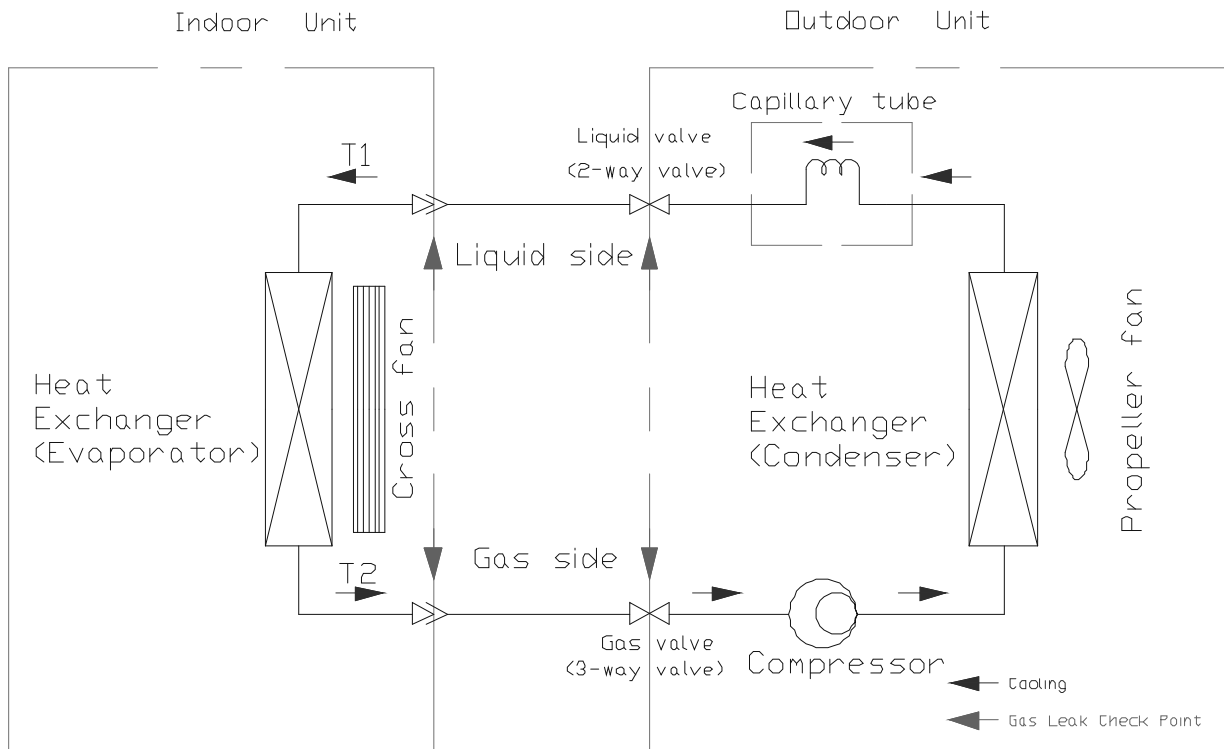

### Cooling Cycle

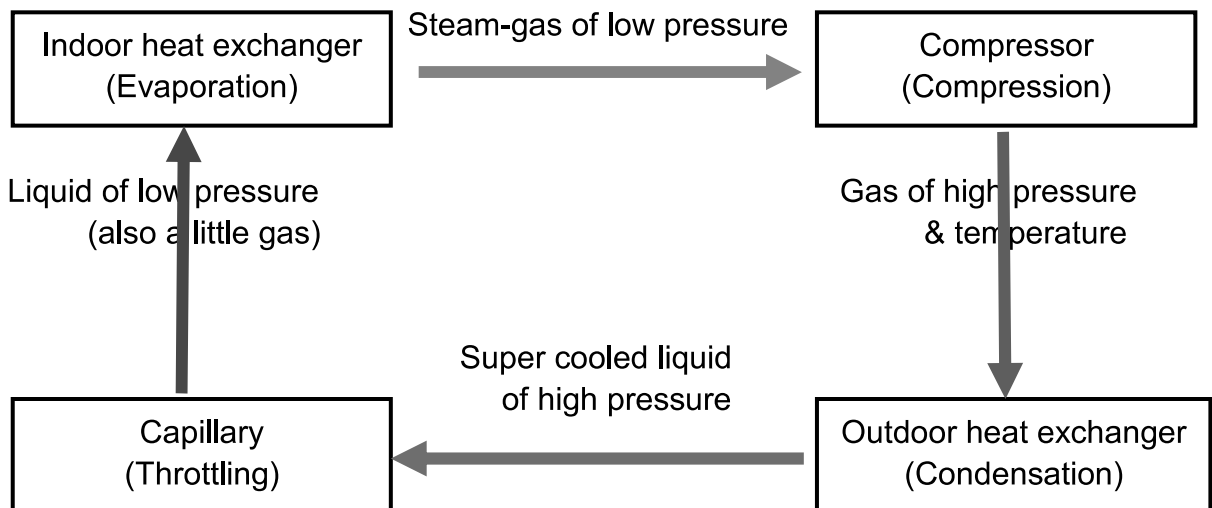

## 2.2 Cooling & Heating

### Cooling Mode

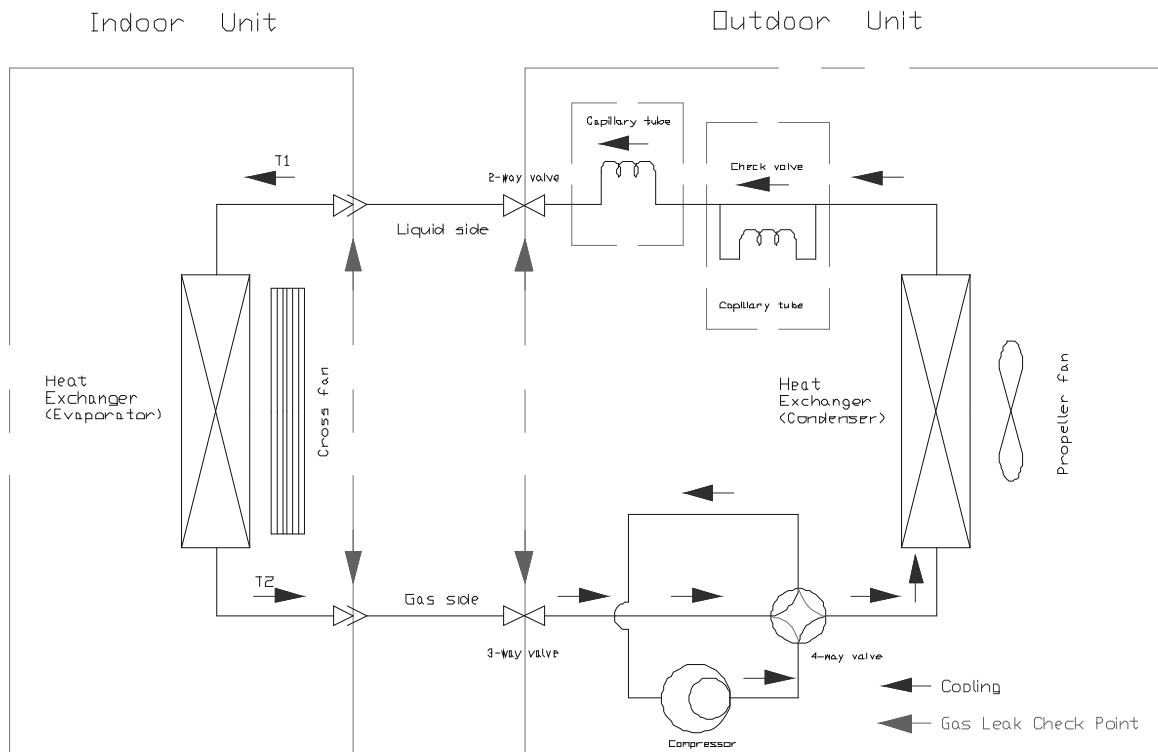

### Cooling Cycle

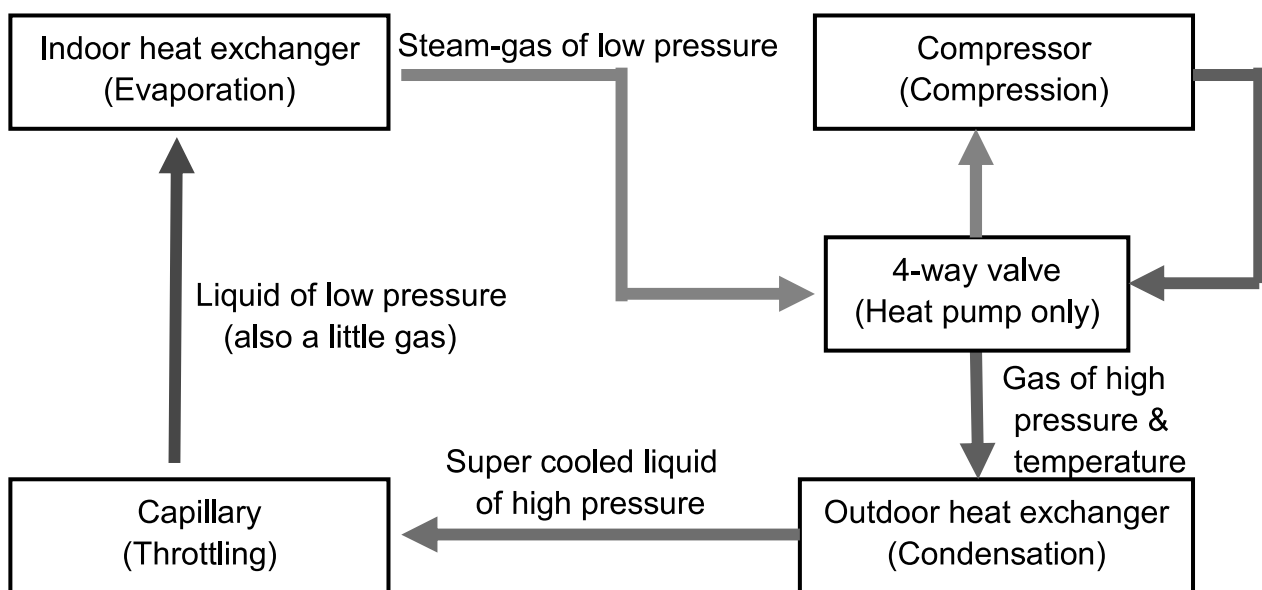

# Heating Mode

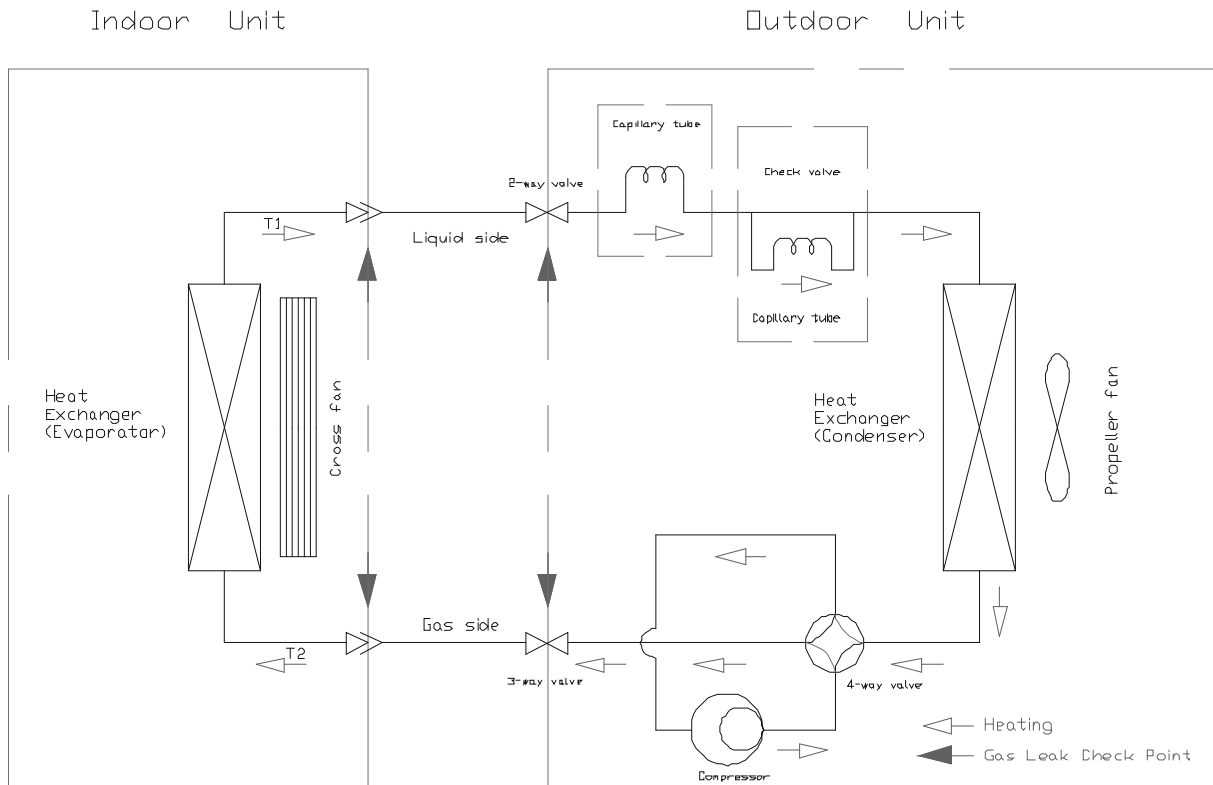

# Heating Cycle

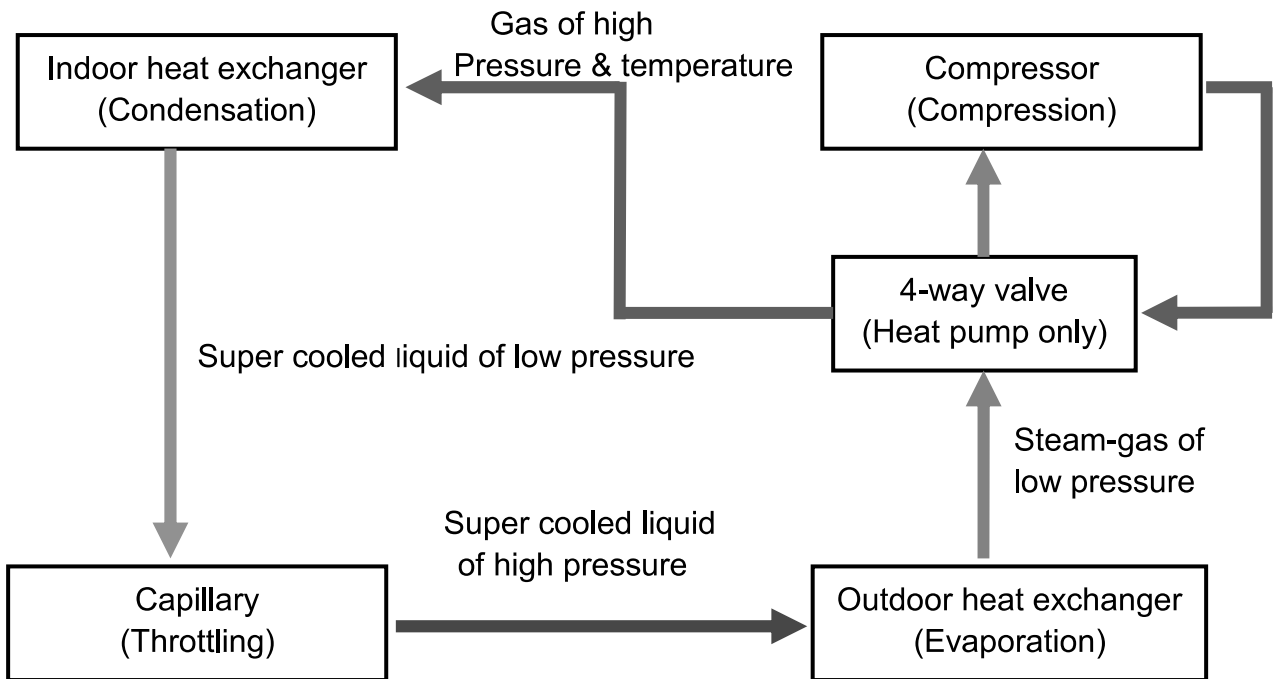

# Chapter 3 Instructions of Installation

- ※ Please read the instructions carefully before installation of the air-conditioner.
- ※ The installation should be carried out by specialists.
- ※ Installing the air-conditioner and connecting the pipe and wires must be strict to reference the instructions.
- ※ The machine power connections is type Y. If the power wires is destroyed, electrical performance should be carried out by electrical specialists.

## Installation order

Selection of the installing position → Installation the air-conditioner → connecting the pipes and wires  
 → Expelling the air in the pipes and the indoor unit → Testing

### Selection of the installing position

#### Indoor Unit

- There is no heating and steaming source nearby.
- No obstacles for installing position nearby.
- Keep good air circulation.
- Convenient to adopt measures to reduce noises.
- Don't install them near the doorway.
- Make sure to have the distance specified in the picture between the ceiling, wall, furniture and other obstacles.
- 2 meters high above the floor.

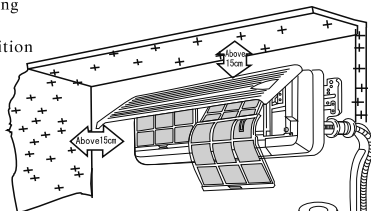

#### Outdoor Unit

- In case that you put up a canopy to protect it from rains and sunrays, pay attention not to cause any obstacles for the heating dispersion for the condenser.
- Don't grow animals or plants near the installation location for the cold and hot air out will affect them.
- Make sure to have the distance specified in the picture between ceiling, wall, furniture and other obstacles.
- Stay away from heating source and inflammable air.
- The installation base and supporting frame should be strong and secure. The machine should be at plane surface.

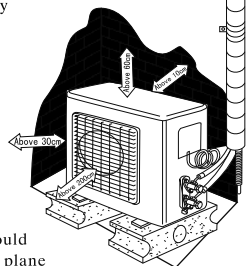

The distance between indoor and outdoor unit should be 5 meters and pipe length can go up to maximum 15 meters with additional refrigerant charge.

Max. Allowable Tubing Length at Shipment(m)	Limit of Tubing Length(m)	Limit of Elevation Difference H(m)	Requires Amount of Additional Refrigerant (g/m)
5	15	5	CC ≤ 12000Btu CC ≥ 18000Btu 20 30

### Warning

- ※ Installation is forbidden in the stairs, the exits and the corridors in the building.
- ※ Make sure that the distance between the support of outdoor unit and the ground is 2.5m.

### Installation of the Outdoor Unit

- The outdoor unit must be firmly fixed to avoid falling in the strong wind.
- Install on the cement base the drawing below.
- If it will be installed at seaside or at a place high above the ground and with strong wind, the AC should be installed against the wall and ensure the normal operation of the fan and the blocking plate should be used.
- If it will be installed in lift type, the structure of the mounting surface should be made of solid stick, cement or materials with equivalent strength, and be of enough bearing capacity. Otherwise, measures such as reinforcement, support or vibration damping should be adopted.

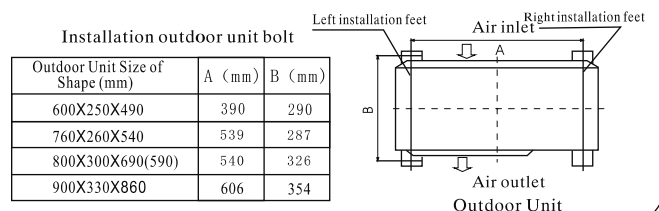



# Installation of the Indoor Unit

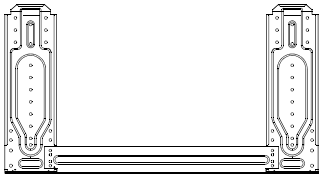

- First make changes to wall and make sure that is hard and secure. Using four “+” type screws to fasten the installation board onto the wall. Keep it water level horizontal direction and perpendicular in vertical direction. Otherwise it might cause water drops when air-conditioner is running cooling operation.

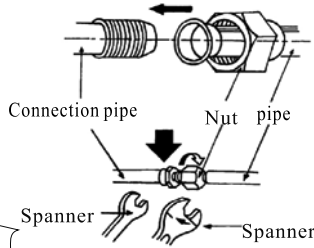
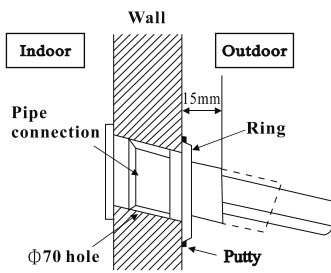

- Pull out the indoor unit pipes after detached the fixed parts on them. Connect the interconnected pipes to the indoor unit: point to the center of pipe and fasten the connection screw at first by hand and then by wrench until you hear the “Click” sound. Fastening direction is shown in the right picture. Using torque is shown in the following table.

Drilling 70mm diameter pipe hole at the left down or right down side of the installation board. The hole shall slant outward slightly.

- Arrange the connection pipes, cable, outflow tube according to the figure, then connect the drain pipe to the draining hole.
- Use insulation sleeve to warp the position of connection pipe and indoor unit, then wrap the insulating tape on the sleeve to avoid condensate water.
- Fasten connection pipes, cables and drain pipe together by plastic strap.

Remove the base support foam in one side before installation

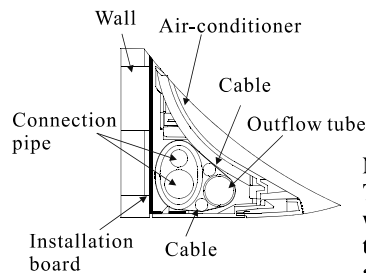
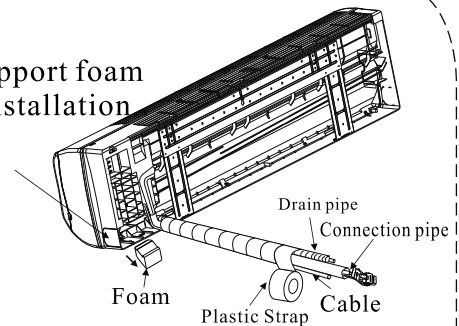

**Note:**  
The installed air-conditioner won't be tightly appressed to the wall if the tubes are not arranged as shown in the picture.

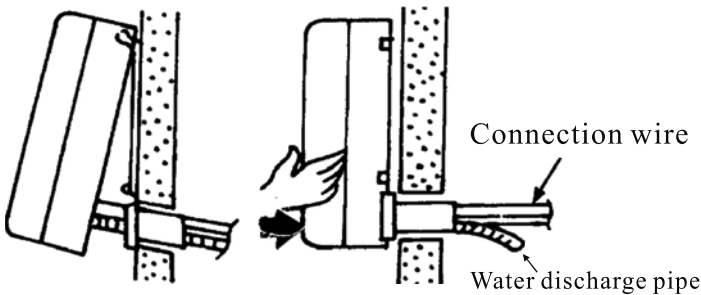

- Hang the indoor unit to the board and make sure the machine is in the middle of the board.
- Pushing the machine towards the left down and right down side of the installation board until the hangers enters tightly the grooves (it makes “click” sound)

# Check the water discharge

1. Take off the frame the unit cover.

Take off the front frame for maintenance according to the following steps:

- Turn perpendicular airflow direction handle from “1” to horizontal direction.
- As shown in the picture on the right, take off two covers from the front frame and then unfasten two fixture screws..
- Pull the front frame towards yourself and take it off.

In case that put the front frame back, turn the perpendicular airflow direction handle from “1” to horizontal, then proceed according to the third and the second steps.

You should check whether the front frame is firmly inside the fixture groove on the top.

2. Check the water discharge

- Put a cup of water into groove.
- Check whether the water flow through the water discharge hole.

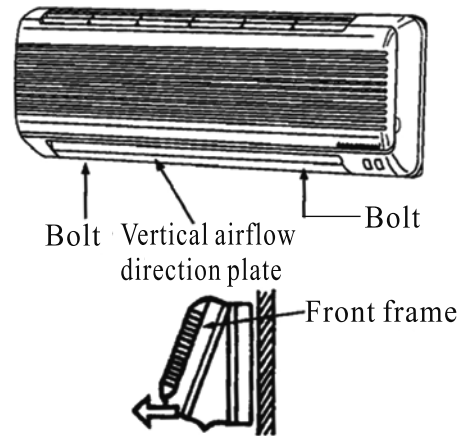

Pull down the front frame towards your and take off the front frame.

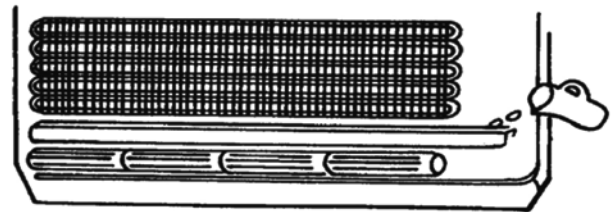

## Pipe Connection

- Connect the pipe to the unit: point to the center of pipe and fasten the connection screw at first by hand and then by wrench until it is tightly fastened, The fastening direction is in the following picture.

The size of pipe	Torque
$\Phi 6.35\text{mm}(\frac{1}{4}'' )$	18N. m
$\Phi 9.52\text{mm}(\frac{3}{8}'' )$	42N. m
$\Phi 12.7\text{mm}(\frac{1}{2}'' )$	55N. m
$\Phi 15.88\text{mm}(\frac{5}{8}'' )$	75N. m

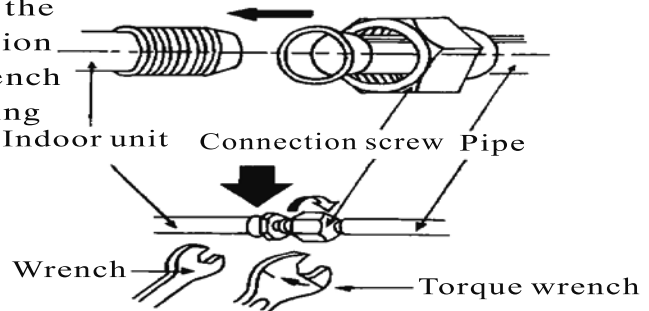

- Pointing towards the center of pipe, fasten the screw with strength.
- Wrench the screw in the end until you hear the "Click" sound.

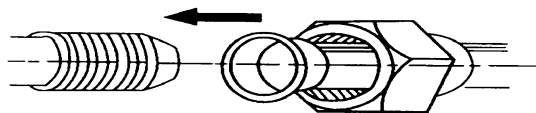

(Refer the direction to the picture)

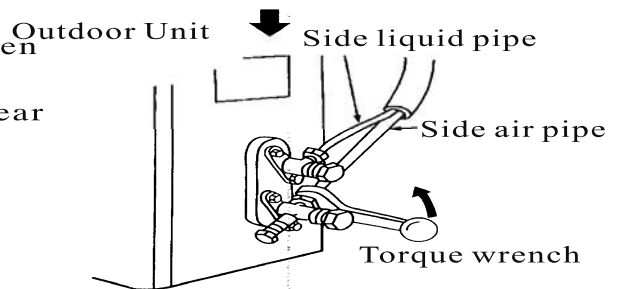

## The form of pipe

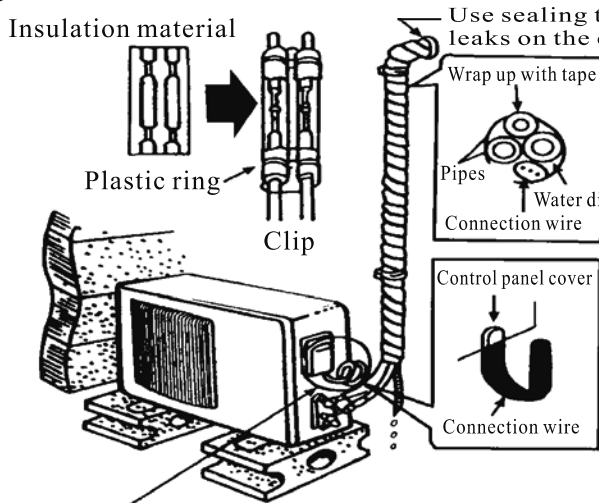

Round in this shape to prevent water entering the electrical parts.

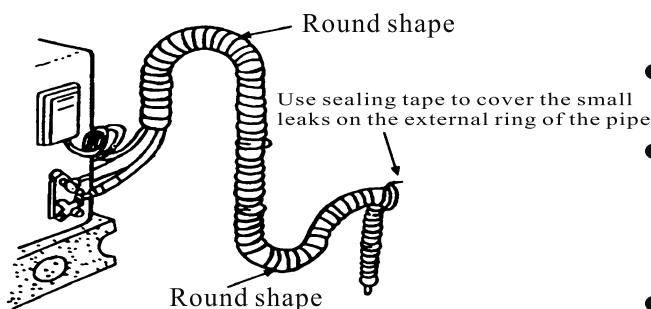

See the picture on the left

- Wrap up all pipe, water discharge and connection wire from top to below.
- Cover the connection parts with insulation material and fix them with two plastic rings.
- Wrap up the pipes with tape alongside the wall and fix them to the wall with clips. These steps are usually adopted when outdoor unit is installed below the indoor unit.
- In case that you want to have additional water discharge pipe, the end of pipe should be within certain distance towards to surface (don't let it under the water. Fix it onto the wall so it won't be swayed by the wind)
- Wrap the pipes and connection wire well from below to top.
- Wrap up the pipes that are rounded up by the wall corners in the way shown in the picture so it can prevent water entering the room.
- Use clips or other fixture to fasten the pipes to the walls.

# Electrical connection

- Unscrew the screw, take off the control panel cover from the unit.
- Connect the cable to their terminals according to their number.
- The grounded wire connection:
  - 1.loosen the grounded screw of electrical shelf.
  - 2.Connect the grounded wire with the grounded screw then setscrew in the “⊕” mark formerly.
- Fix the cable to the terminal board with fastening piece.
- Reinstall the cover with the screw.

## NOTE:

- ※Don't reverse the power polarity.
- ※The wrong connection lead to the mal function of some electrical parts.
- ※Must fix the screw nail of the firmly wire, then drag the wire lightly, confirmation whether it's firmly.
- ※Must changed if the wire slide, the self-drive screw can't used to the electric connection.
- ※If there is a connector, connect it directly.

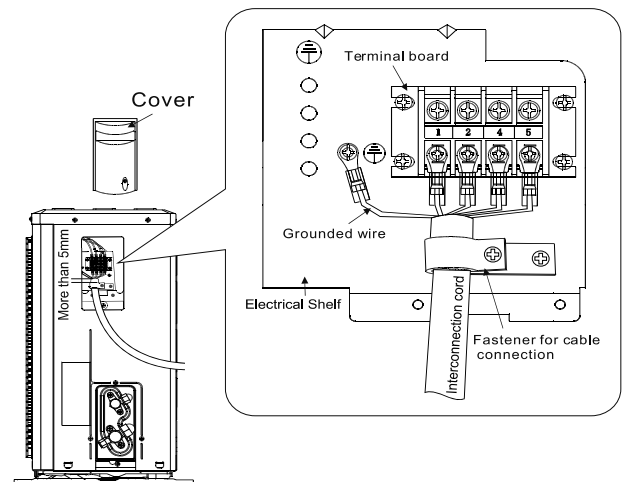

Cold wind Type  
Terminal board for outdoor unit

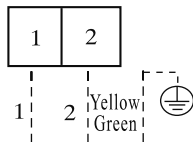

Temperature control wire connector  
(only for heat pump type)

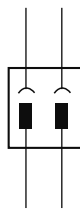

Compressor signal wire connector and  
temperature control wire connector  
(only for heat pump type 6000W/7000W)

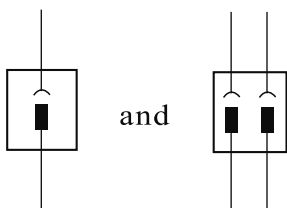

Single wire      Double wires

Heat-pump type  
Terminal board for outdoor unit

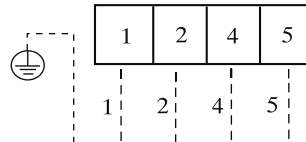

Compressor signal wire connector  
(only for cooling pump type  
6000W/7000W)

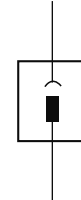

**Note:**  
**Explanation for the power cord without  
plug (see below figure):**

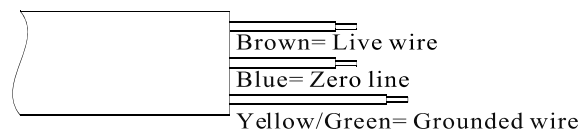

## Expelling the air in the pipes and the indoor unit

**Expelling the air:** humid air in the refrigerating system might cause trouble of compressor.

- Take off the cover from the stop valve and T-branch valve.
- Take off the auxiliary cover from the T-branch valve.
- Turn the stop valve rod anti-clock wise to an angle of 90 degree, keep it open for 8 seconds and close the valve.
- Check whether there is air leakage at all connection parts of pipes.
- Push the top rod of T-branch valve by hexagon wrench to expel air.
- Repeat the third and fifth steps.
- Open the stop and T-branch valve with a hexagon wrench to make the unit operate.
- There is no leakage allowed, please check all the piping connection parts. You must test the leakage, generally, it can be tested by soap water.

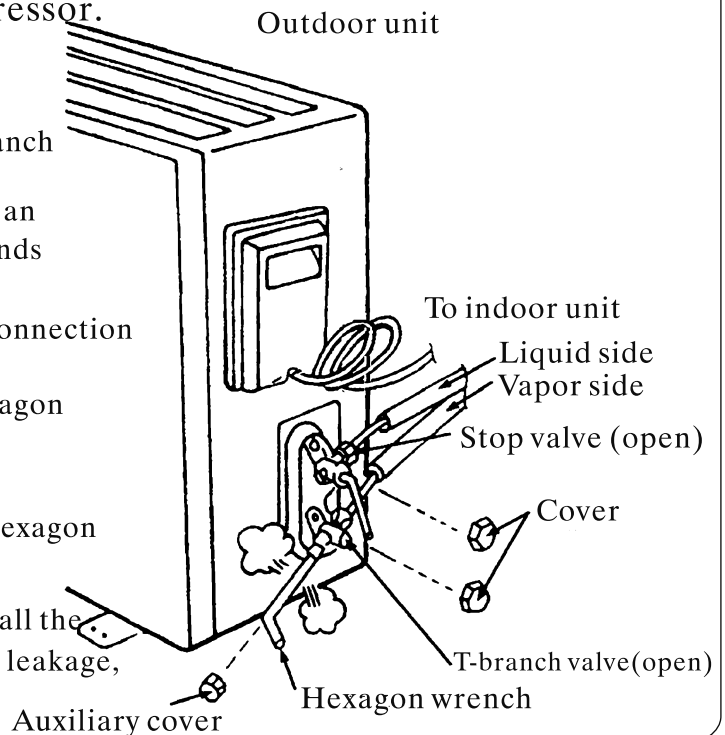

## Test running

- Make sure that the pipes and wires are connected.
  - Make sure that the liquid side valve and air side valve both are completely open.
- 1. The connection of power source**
- Connect the wire to independent power source socket
  - Preparation of remote controller.
  - Run the air-conditioner in cooling operation mode for 30 minutes or longer.
- 2. Performance evaluation**
- Test the out and in air temperature.
  - Make sure whether the outlet air temperature subtract from inlet's gives more than 10°C .

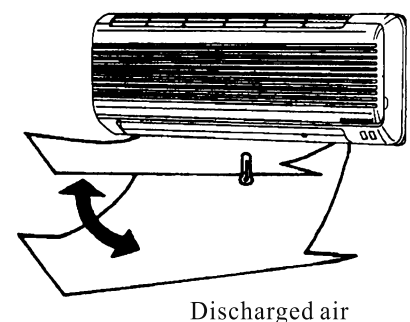

# Chapter 4 Remote Controller Introductions

## AIR-CONDITIONER REMOTE CONTROLLER

### INSTRUCTIONS

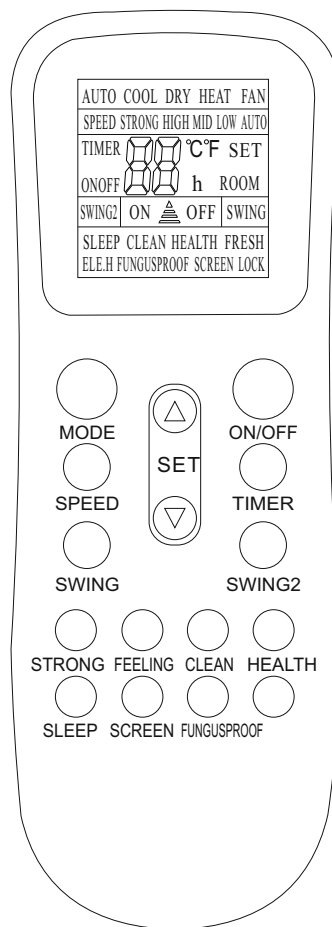

- Read this “instructions” carefully so that you can use the air-conditioner safely and correctly.
- Take good care of the “instructions” so that it can be referred to at any time.

# Buttons description

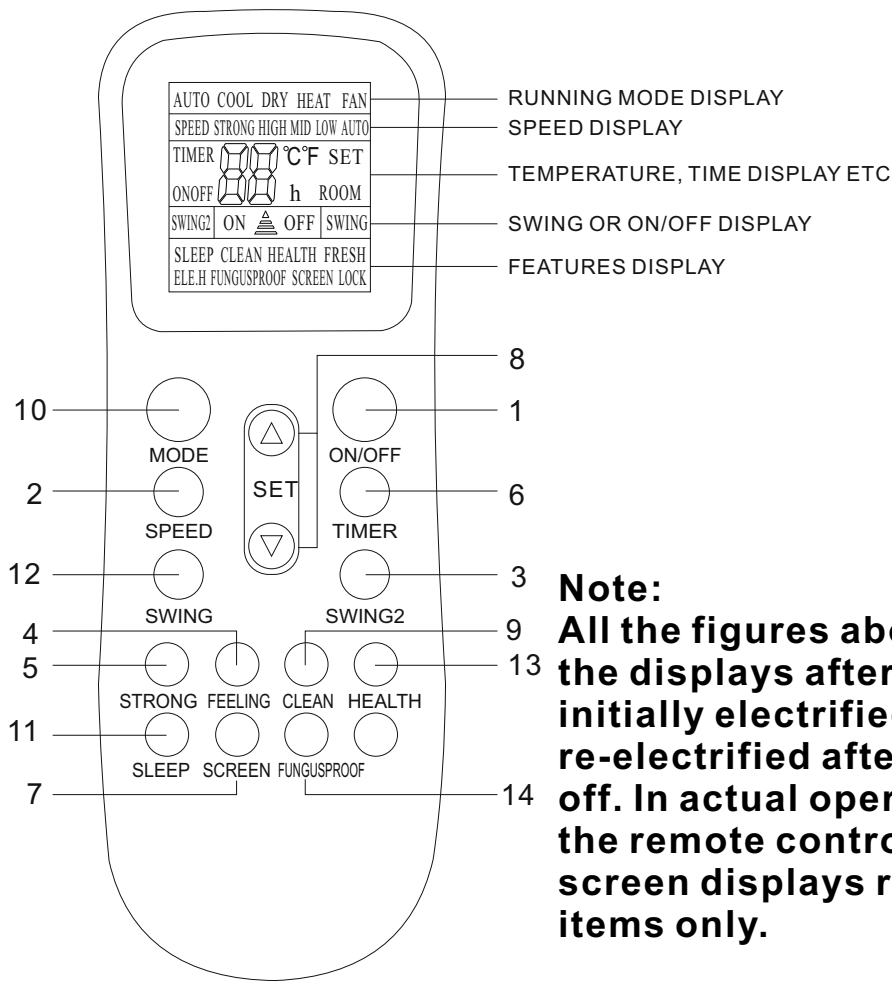

**Note:**  
**All the figures above are the displays after being initially electrified or re-electrified after power off. In actual operations, the remote controller screen displays related items only.**

**Note: The picture is general remote controller, contains almost all of the function buttons. They may be slightly different from material object(depend on model).**

## 1. ON/OFF button

You can start or stop the air-conditioner by pressing this button.

## 2. SPEED button

You can select fan speed as the following:



## 3. SWING2 button

Press this button, the vertical wind direction vanes can rotate automatically, when you have the desired horizontal wind direction, press it again, the vertical wind direction vanes will be stopped at the situation of your choice.

#### 4. **FEELING** button

When it displays **FEELING** button:

Press this button can be used to set the feeling function. The LCD shows the actual room temperature when the function set and it shows the setting temperature when the function cancelled. This function is invalid when the appliance at the Fan mode.

#### 5. **STRONG** button

Only under the state of cooling or heating mode, press this button, the fan speed is adjusted to strong auto-matically and the LCD displays high fan, the strong function is started to reach the highest cooling or heating.

#### 6. **TIMER** button

##### **Setting the ON timer time**

- a. When remote controller is at off state, press **TIMER** button, the LCD displays **TIMER ON** and the timer time, the range of setting time is 0.5h to 24h.
- b. You can press the button to adjust the timer time, each touch will be set time to increase or reduce 0.5h before 10 hours ago, after ten hours will be set time to increase or reduce 1h per pressing, to enables your required timer.
- c. Press **TIMER** button again, to set the timer on function.
- d. You can set another function to insure the suitable state after air conditioner turn on (including mode, temperature, swing, fan speed and etc). The LCD will displays all your setting and keep it, when the timer reach to the set time, the air conditioner will be working according to your set automatically.

##### **Setting the OFF timer time**

- a. When remote controller is at on state, press **TIMER** button, the LCD displays **TIMER OFF** and the timer time, the range of setting time is 0.5h to 24h.
- b. You can press button to adjust the timer time, each touch will be set time to increase or reduce 0.5h before 10 hours ago, after ten hours will be set time to increase or reduce 1h per pressing, to enable your required timer.
- c. Press **TIMER** button again, to set the timer off function.

#### 7. **SCREEN** button

You can let the LCD display working or not by pressing this button.



## 8. **SET UP+** or **DOWN-** button

Press the **SET+** or **SET -** button, you can set the temperature range from 16 to 32, Display will change when you touch the button.

## 9. **CLEAN** button

- a. When remote controller is at the off state, press **CLEAN** button, the wind guiding bars turn to initial positions for cooling, the A/C runs **CLEAN** function with max duration 35mins. The purpose of this function is to clean dust on evaporator and dry the inside water of evaporator and to prevent the evaporator going moldy due to water deposition and boasting strange smell.
- b. After setting **CLEAN** function, press **CLEAN** button again to cancel **CLEAN** function or press **ON/OFF** button to cancel **CLEAN** function and start A/C.
- c. The clean function will be stop working after 35 minutes running working without any operation.

**Note: clean function can be set in parallel with time start function; in this case , time start function will be executed after clean function.**

## 10. **MODE** button

Which enables you to select different operation mode, after each pressing, the operation mode will be changed. It shows in the following display.

AUTO-COOL-DRY-HEAT-FAN-AUTO

**Remark: cold wind type has no heating function.**

## 11. **SLEEP** button

1. Press the **SLEEP** button, the sleeping indicator light of indoor unit flashes on.
2. After the setting of sleeping mode, the cooling operation enables the set temperature to increase 1 after 1 hour and another 1 automatically after 1 hour.
3. After the setting of sleeping mode, the heating operation enables the set temperature to drop 2 after 1 hour and another 2 automatically after 1 hour.
4. The air-conditioner runs in sleeping mode for 7 hours and stops automatically.

**Remark: press the **MODE** or **ON/OFF** button, the remote controller clears sleeping mode away.**

## 12. **SWING** button

Press this button, the horizontal wind direction vanes can swing automatically, when you have the desired vertical wind direction, press it again, the horizontal wind direction vanes will be stopped at the situation of your choice.

## 13. **HEALTH** button

Press this button, you can turn on or off the health function.

## 14. **FUNGUSPROOF** button

This A/C has special dry and anti-mold function which has yes or no two selections. This function is controlled by the remote controller under cooling, dry and auto (cooling and dry) modes, the horizontal wind guiding bars are at the initial position for cooling. The A/C runs under heating mode (the cooling only A/C only runs under fan mode), the internal fan runs for three minutes with weak wind before stop. The purpose of this function is to dry the inside of the evaporator and to prevent the evaporator from going mouldy due to water deposition and thus dispersing strange smell.

### **Note:**

- 1. This function has not been set in the factory. You may freely set and cancel this function. The setting method is: under off status of the A/C and the remote controller, point the remote controller toward the A/C and continuously press FUNGUSPROOF pushbutton for one time, the buzzer keep beeping five times again after five times beep, indicating that this function is ready. In case this function has been set, unless the whole A/C is powered off or the function is manually cancelled, the A/C then has this function as default;**
- 2. To cancel the function: 1. Power off the whole A/C; 2. Under off status of the A/C and the remote controller, point the remote controller toward the A/C and continuously press FUNGUSPROOF pushbutton for one time, the buzzer keep beeping three times again after five times beep, indicating that this function has been cancelled;**
- 3. When this function is on, it is suggested not to restart the A/C before it is completely stop;**
- 4. This function will not run in case of time stop or sleep stop.**

# Usage

## ★ Fix batteries

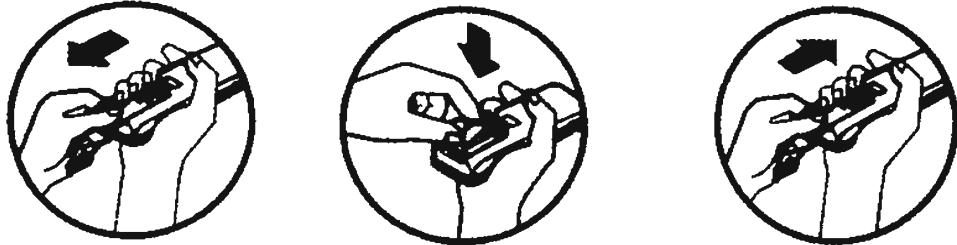

1. Slide open the cover according the direction indicated by arrowhead.
2. Put into two brand new batteries (7#), position the batteries to right electric poles (+J-).
3. Put back the cover.

## ★ Automatic operation mode

1. Press the ON/OFF button, the air-conditioner starts to operate.
2. Press the MODE button, select the automatic operation mode.
3. Press the SPEED button, you can select fan speed.  
You can select fan speed from LOW, MID, HIGH, AUTO.
4. Press the button again, the air-conditioner stops.

## ★ Cooling/Heating operation mode (cold wind type has no heating function)

1. Press the ON/OFF button, the air-conditioner starts to operate.
2. Press the MODE button, select the Cooling or Heating operation mode.
3. Press the SET+ or SET- button, set the temperature, temperature can be set at 1 difference range from 16-32.
4. Press the SPEED button, you can select fan speed.  
You can select fan speed from LOW, MID, HIGH, AUTO.
5. Press the button again, the air-conditioner stops.

## ★ Fan operation mode

1. Press the ON/OFF button, the air-conditioner starts to operate.
2. Press the MODE button, select the Cooling or Heating operation mode.
3. Press the SPEED button, you can select fan speed. You can select fan speed from LOW, MID, HIGH.
4. Press the button again, the air-conditioner stops.

**Remark: In the circulation operation mode, to set the temperature is noneffective.**

## ★ Drying operation mode

1. Press the ON/OFF button, the air-conditioner starts to operate.
2. Press the MODE button, select the Dry operation mode.
3. Press the SET + or SET - button, set the temperature, temperature can be set at 1 difference range from 16-32.
4. Press the SPEED button, you can select fan speed. You can select fan speed from LOW, MID, HIGH, AUTO.
5. Press the button again, the air-conditioner stops.

### **Note:**

**This manual introduces function for all of the remote control, maybe you press one button without any reaction, well, the air-conditioner you bought hasn't this function.**

# Attention

1. Aim the remote controller towards the receiver on the air-conditioner.
2. The remote controller should be within 8 meters away from the receiver.
3. No obstacles between the remote controller and receiver.
4. Do not drop or throw the remote controller.
5. Do not put the remote controller under the forceful sunrays or heating facilities and other heating sources.
6. Use two 7# batteries, do not use the electric batteries.
7. Take the batteries out of remote controller before stop its using for long.
8. When the noise of transmitting signal can't be heard indoor unit or the transmission symbol on the display screen doesn't flare, batteries need be replaced.
9. If reset phenomenon occurs on pressing the button of the remote controller, the electric quantity is deficient and new batteries need to be substituted.
10. The waste battery should be disposed properly.

# Chapter 5 Brief Introduction for Usage

## Parts Description

### ★ Indoor Unit

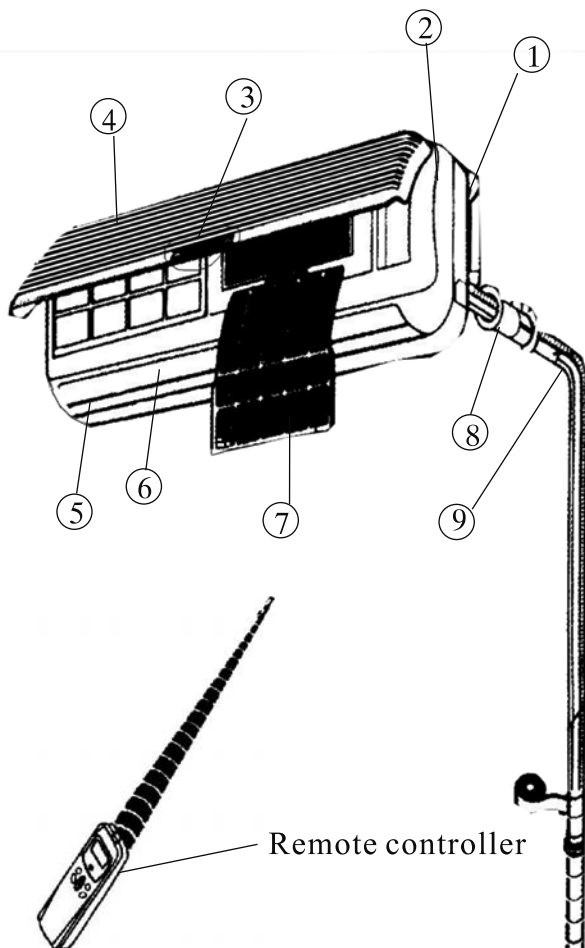

#### ● Indoor Unit

- ① Installation board
- ② Middle frame
- ③ Indication light and signal receiver
- ④ Front panel
- ⑤ Horizontal airflow direction vane
- ⑥ Vertical airflow direction vane(inner)
- ⑦ Air filter
- ⑧ Pipe protection ring
- ⑨ Drain pipe

### ★ Outdoor Unit

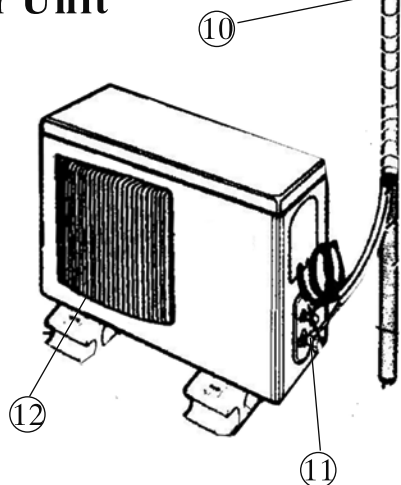

#### ● Outdoor Unit

- ⑩ Pipe and Drain pipe
- ⑪ Cut-off valve
- ⑫ Outlet cover

Fig.1

#### Note:

The appearance of the units in Figure 1 is for illustration purpose only.

## Usage

### ★ Working condition

Cooling	Indoor	Maximum:	DB/WB	32°C/23°C
		Minimum:	DB/WB	21°C/15°C
	Outdoor	Maximum:	DB/WB	43°C/26°C
		Minimum:	DB/WB	21°C/15°C
Heating	Indoor	Maximum:	DB/WB	27°C-
		Minimum:	DB/WB	20°C-
	Outdoor	Maximum:	DB/WB	24°C/18°C
		Minimum:	DB/WB	-5°C/-6°C

### ★ Remote control usage

See “Air-conditioner Remote Control Instruction”

### ★ Hand control operation

#### ☆ Forced operation

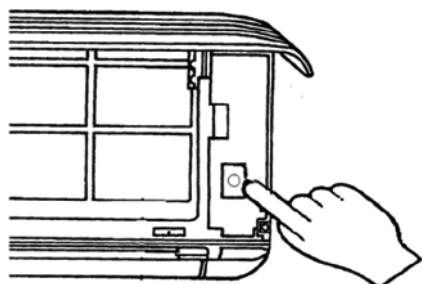

- ① In case the remote control is not in hands, and the air-conditioner is operating. Press the “forced operation” button to make it stop. Press the button a second time, it starts to operate.
- ② In case the remote control does not work, press the “forced operation” button, which is an automatic operation.  
The airflow direction is adjusted automatically.

### ☆ Air flow direction adjusting

#### 1. Horizontal air flow direction adjusting

Move the vane and change the horizontal wind direction with hands.

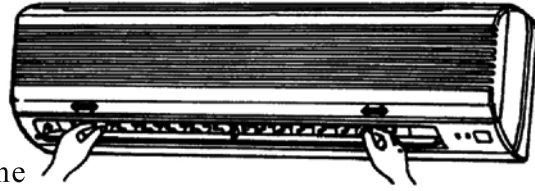

#### ⚠ Note:

Adjust the horizontal air flow direction before the air-conditioner starts. Do not put reach your finger into air-out window when the air-conditioner is operating.

#### 2. Vertical air flow direction adjusting

Refer to “Remote Control Usage Instruction ” for how to adjust vertical air flow direction through adjusting the horizontal airflow vane by remote control.

#### ⚠ Note

- Adjust the vertical air flow direction by remote control. When you adjust the horizontal airflow vane by hand, the machine may cause problem.
- When the air-conditioner stops, the horizontal wind vane will close the wind outlet of air-conditioner.

### Items of attention

Please read this instruction carefully before using the air-conditioner, you are strict to operate according to the instruction. Otherwise, there may be damage to the air-conditioner or to the other person's safety and property.

### ★ Checking before usage

- The grounding wire is connected safely and reliably.
- The filter is properly fixed.
- If not using for a while, please clean the filter before starting the air-conditioner, see “Maintenance” for how to operate.
- Make sure that air outlet and inlet are not blocked.

### ★ Safety rules

#### ⚠ Note

- Installation should always be carried out by a licensed and qualified technician . The customers should not install the air-conditioner by themselves, Otherwise, there may be damage to the air-conditioner or to the other person s safety and property.
- In order to properly use the air-conditioner ,please follow the Working condition in the instructions, otherwise, it may activate the inside protection, or lead to weeping, or decrease the cooling/heating efficiency.
- Set the suitable temperature, especially when there are aged people, children and patients in the room. Generally ,keep the temperature difference between the inside and outside within 5°C.
- In the case the air-conditioner closes down or gash due to the severe interference from outer environments such as auto and mobile phone etc., please take off the plug and then plug in after several seconds to restart the air-conditioner.



## ★ Optimal operation

Pay attention to the following items so as to ensure optimal operation of the system, details of operation see the relevant content.

- Please set the scheduled operation time with the remote control.
- Set the suitable temperature for a comfortable environment. Do not make the room too cold or too hot.
- During the cooling operation, do not allow let the sunlight to come into the room, please pulldown the window shades or veils.
- Close the windows and doors. Otherwise, it will decrease its cooling or heating capacity.

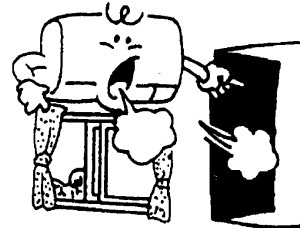

- Make sure that air outlet and inlet are not blocked, or it may decrease the efficiency of the air-conditioner, even stops the operation of the system.
- If the air filter is blocked, the cooling or heating capacity will be affected. Please regularly clean the air filter.

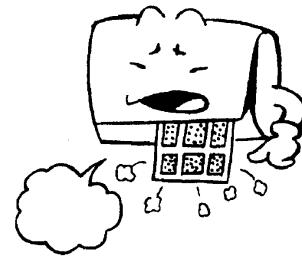

### ⚠ Warning

- The primary power switch should be placed out of reach of children to prevent the child from the danger of electric shock.
- In lighting storm weather, please cut off the primary power supply switch in order to prevent the machine from damage.

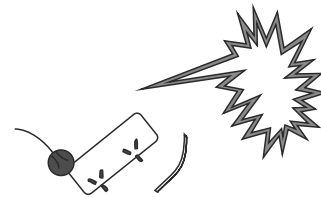
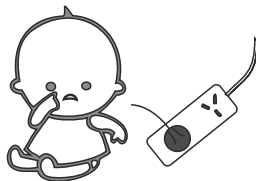

- If not using for a long period of time please cut off the primary power supply switch to avoid incident.
- Liquid detergent or corrosive detergent should not be used for cleaning the machine and sprinkle water or other liquid onto it. Otherwise it may result in damages on the plastic components of the case, even electric shock.

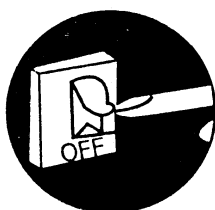

Cut off the power supply switch

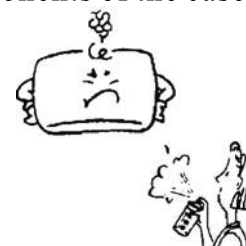

**⚠ Danger**

- Do not put your hands or stick-shaped objects into the air outlet of the indoor and outdoor unit, otherwise, the rotating fan at high speed may cause injury to you.

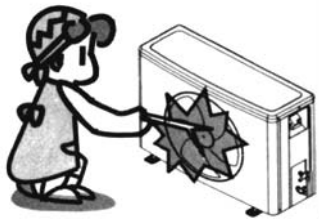

- Do not touch the swinging wind vanes, or it may clamp your finger and damage the driving parts of the wind vanes.



- In case that abnormal phenomenon occurs such as unusual noise, smoke or electric leakage etc., please immediately cut off the power supply and then contact with the service centre do not try to repair it by yourself.



- Do not pull the power cord, The damage of power cord will cause serious electric shock.



- Do not use and store flammable gas or liquid such as fixture, paint or gasoline close to the air-conditioner to avoid fire hazard.

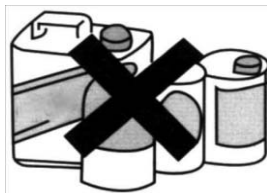

- Do not operate with wet hands or in damp environment. it will cause electric shock.



- Keep the indoor unit and the remote control dry to avoid short circuit , even fire accident.

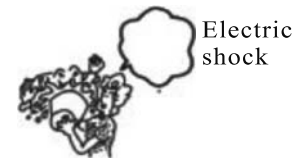

- Do not split the fan cover to avoid the possible injury by the rotating fan at high speed.
- Do not allow the children to touch the air-conditioner to avoid the possible danger.

**Maintenance**

**★ Failure type and methods of resolution**

In case the following situation, please immediately stop the operation of the air-conditioner and cut off the power supply, then contact the service centre.

Failure type	The RUN light or other display light flashes rapidly and keep flashing after the plug is taken off and then plugged in.
	The fuse blows repeatedly or the circuit breaker is activated repeatedly.
	Object or water from outside comes into the air-conditioner.
	The remote control does not work or the switch operates unusually .
	Other abnormal phenomenon.

In the following situations, please handle it according to the following methods, if it does not work, please contact service centre and inform the failure details.

Failure	Causes	Methods of resolution
Start-up failure	Power supply failure	Wait for the recovery of power supply
	The power switch is released	Switch on the power
	The fuse is burnt	Replace the fuse
	The battery is exhausted	Replace the battery
	It does not reach the set time for start up	Wait or eliminate the original setting
The wind blowing out, but the cooling/heating effect is inefficient	Mistakes in temperature setting	Set a proper temperature, see the methods of application
	The air filter is blocked by dust	Clean the air filter
	The air inlet or outlet of machine is blocked	Remove the obstruction
	The doors or windows are open	Close the doors and windows
The wind blowing out, but it does not refrigerate	The air inlet or outlet of machine is blocked	Remove the obstruction, then restart it
	Compressor has three minutes protection	Wait
	Mistakes in temperature setting	Set a proper temperature

## ★ Non-air-conditioner problem

The normal protections of the air-conditioner

### 1. Compressor protection

The compressor do not restart after stop operating in 3 minutes.

#### ● Cold wind prevention (heat pump type )

In the heating mode, the indoor unit will not send wind or operate in low wind ,if the heat exchanger of indoor unit has not reached the stipulated temperature in the following three states, so as to prevent the cold wind.

- ①the heating operation just starts
- ②frost dissolving operation
- ③operating under low temperature

#### ● Frost dissolving operation (hot pump type )

When the temperature is low and humidity is high outdoors, the heat exchanger of outdoor unit may frost, which may decrease the heating capacity. In such case, the air-conditioner will stop the heating operation and convert to automatic frost dissolving, and then resume heating after the frost dissolving finishes.

- (1) The fan of the indoor and outdoor unit will stop under frost dissolving operation.
- (2) The time for frost dissolving varies in range of 4 to 10 minutes according to the outdoor temperature and the frost condition.
- (3) It is normal phenomenon that there may be steam coming out from the outdoor unit during the frost dissolving operation.

2. White steam comes out from the indoor unit

During the cooling operation , under high relative humidity indoors, white steam may come out due to the high humidity and temperature difference of air inlet and outlet.

The air-conditioner converts to heating operation after the frost dissolving, the moisture due to frost dissolving is discharged in form of steam.

3. High noise during operation

When the compressor is operating or just stops operation, fizzle may be heard because of the refrigerant flow or stop flowing.

After the air-conditioner operates or stops for a while, crackle from the naturel expansion and contraction of the plastic components may be heard because of temperature variation. When the air-conditioner is energized for the first time, sound from friction may be heard because of the rotating of wind wave.

4. Dust is blown out from the indoor unit

When the air-conditioner is used for the first time after being left unused for a long time, the dust inside the indoor unit will be blown out.

5. The peculiar smell emanates from indoor unit

The smell which absorbed from room, furniture, clothing or cigarette emanates during the air-conditioner is operating.

6. Cooling /Heating (not for cold wind type) operation converts to only wind mode.

When the indoor unit reaches the stipulated temperature, the air-conditioner will stop the operation of compressor and convert to only wind mode. The compressor will restart cooling or heating after the room temperature rise or drop to a certain degree.

7. If you select the cooling operation in a relatively damp environment (relative humidity is higher than 80%), dew may be formed over the surface of indoor unit and drop. In such case, please adjust the vertical wind vanes to its maximum ventilation position(i.e., close to the position normal to the horizontal direction)and choose “high” to improve the dew phenomenon.

8. Heating operation (heat pump type )

During the heating operation ,the heat pump of air-conditioner operates with the principle of absorbing heat outdoor and release heat indoor.

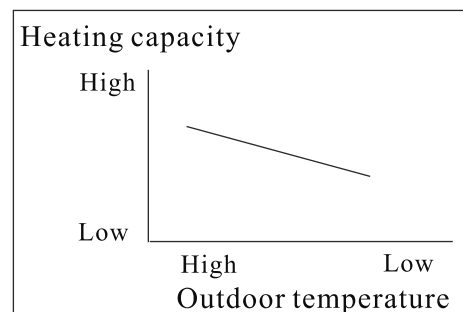

When the outdoor temperature falls, the heating capacity decrease accordingly because the heat absorbed from outdoors decreases (See the figure at the right).At the same time, the temperature difference between indoors and outdoors is enlarged, so that the heating load increase accordingly. If the air-conditioner can not reach a satisfactory effect, it is recommended that other heating devices to be used together.

9. The power cable should be H05VV-F. The connecting cable should be H07RF.

## ★ Cleaning

### ⚠ Warning:

For safety purposes, please turn off the air-conditioner and cut off the power supply before cleaning.

### ☆ Cleaning the indoor unit

1. Wipe the indoor unit with dry cloth .
2. If the indoor unit is very dirty, please wipe with wet cloth dipped by cold water.
3. The panel of indoor machine may be taken off. Dry it with dry cloth after cleaning.

- ⚠ **Note :**
- Do not use dedusting products by chemicals or place close to the machine.
  - Do not use harsh chemicals or abrasive cleaners on any part of the unit.

### ☆ Cleaning air filter

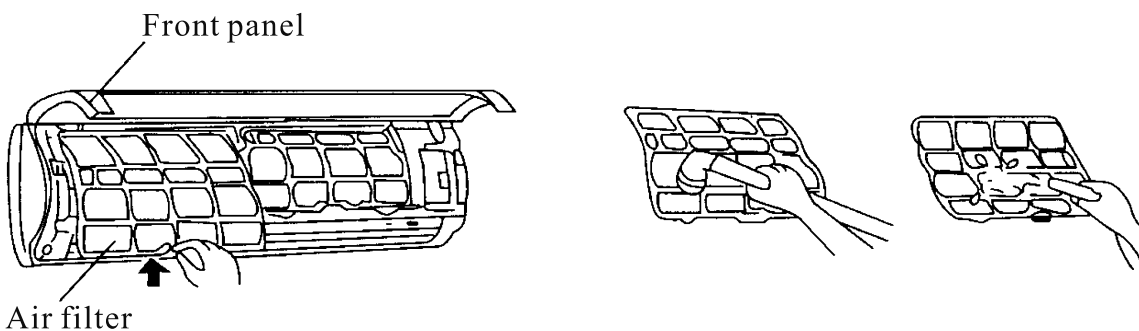

If the air filter is cover by dust, he cooling effect will be undermined. Please regularly clean the air filter.

1. Raise up the front panel of indoor unit until it suddenly stop; then raise up the protruded part of air filter and pull it out downwards.
2. Use vacuum cleaners or water to clean the air filter, then dry it in a dark and cool place.
3. Insert the upside of air filter into the machine until being entirely fixed, close the front panel and tighten it.

## ★ Maintenance

- After the air-conditioner is left unused for a long period ,check the inlet and outlet of indoor and outdoor unit for any possible blockage, if so, please clean it.
- If the air-conditioner will be left unused for a long period, please make the following preparation.

1. Select the “circulation” operation mode, make the air-conditioner run for a long time to dry.



3. Take out the battery in the remote control.

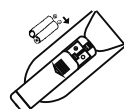

2. After stopping operation, Cut off the power supply

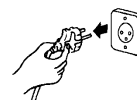

4. The inner components of the outdoor unit should be regularly check and clean.



## Installation

- ▲ The installation must be carried out by a licensed and qualified technician only.

### ★ Guide of customer

- The customer should have a qualified power supply coincident with the tag of the air conditioner, its voltage should be in the range of 90-110% of its rated voltage.
- The power supply circuit should have leakage protector and air switch of which the capacity should be more than 1.5 times of the maximum current.
- Only use special circuit and efficient grounding socket matching with the plug of air-conditioner.
- The wiring must be done by qualified electrician according to the electrical safety requirements.
- The air-conditioner must be well grounded, and the switch of the main power of air-conditioner must be reliably grounded.
- Do not pull the power supply wire.

### ★ Installation position

See “*Installation Instruction*”

### ★ Items of attention

- Fix the machine firmly, otherwise it will produce noise and vibration.
- Install the outdoor unit where it will not disturb your neighbor.

## WEEE Warning

### Meaning of crossed out wheeled dustbin:

Do not dispose of electrical appliances as unsorted municipal waste, use separate collection facilities.

Contact you local government for information regarding the collection systems available.

If electrical appliances are disposed of in landfills or dumps, hazardous substances can leak into the groundwater and get into the food chain, damaging your health and well-being.

When replacing old appliances with new ones, the retailer is legally obligated to take back your old appliance for disposals at least free of charge.

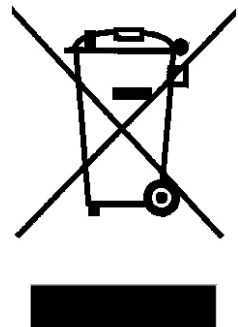

# Chapter 6 Wiring Diagram

## 6.1 Electric chart for 09/12K(Non inverter)

### Indoor unit

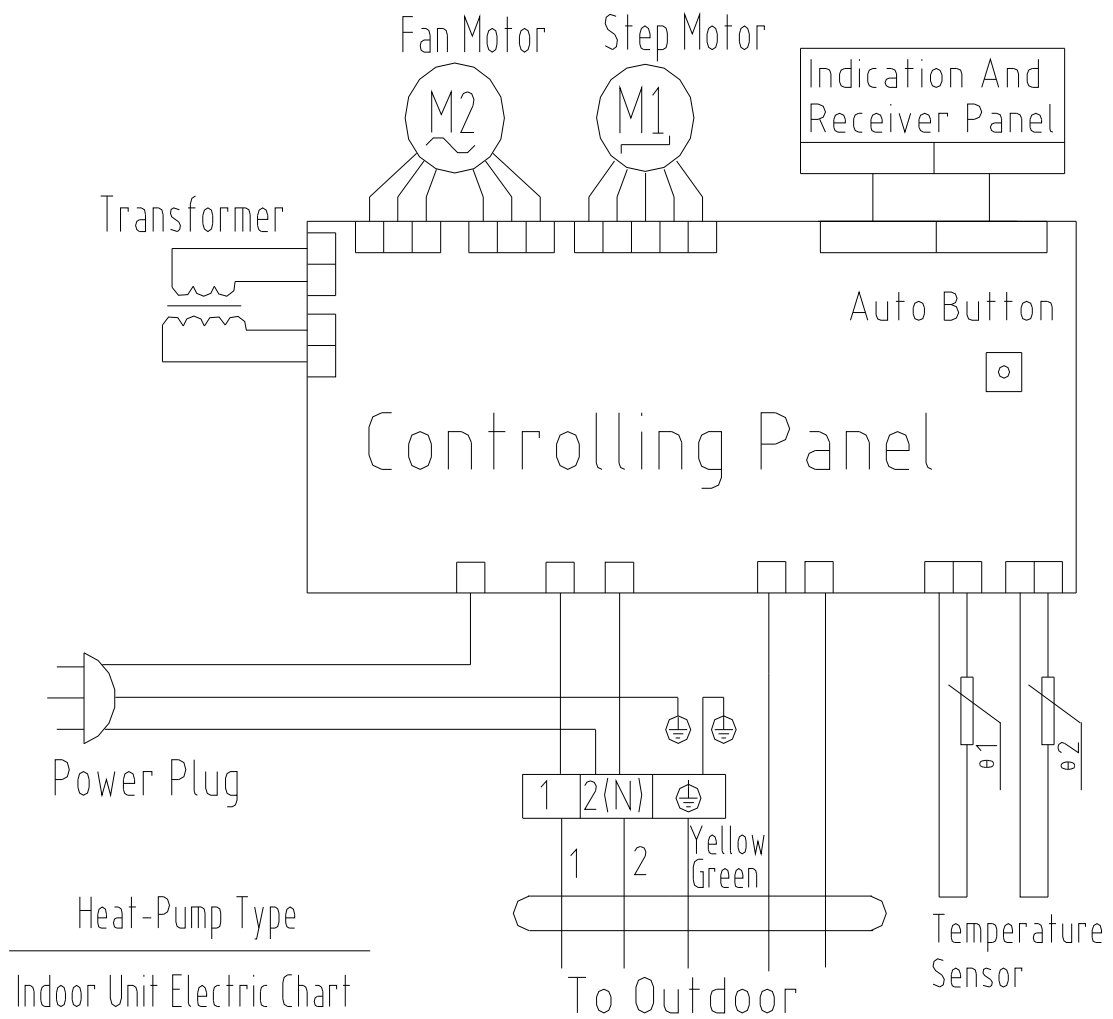

# Outdoor unit

Fan Motor Red

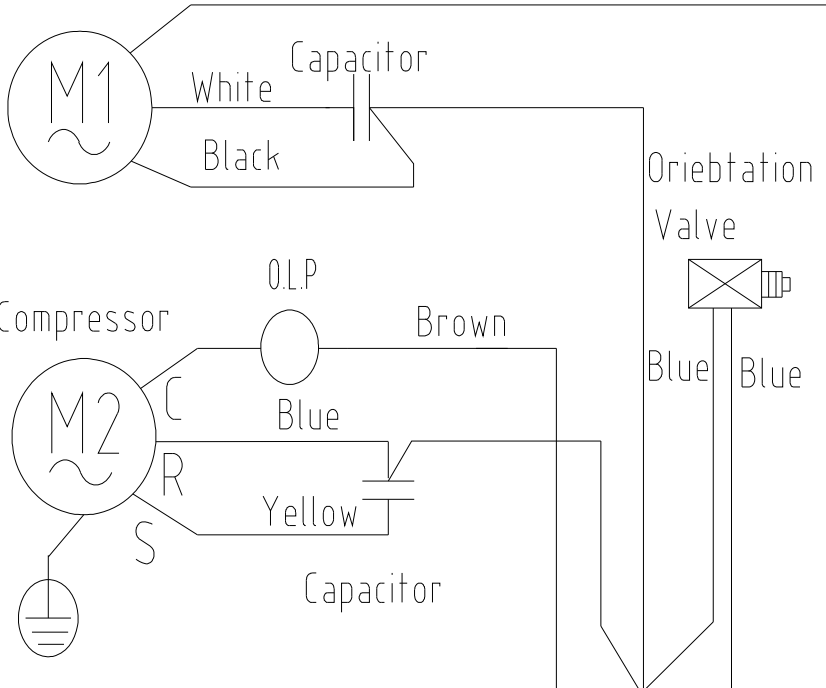

Some Models with Compressor of In-side Overload Protect

1886R003392

Outdoor Unit Electric Chart

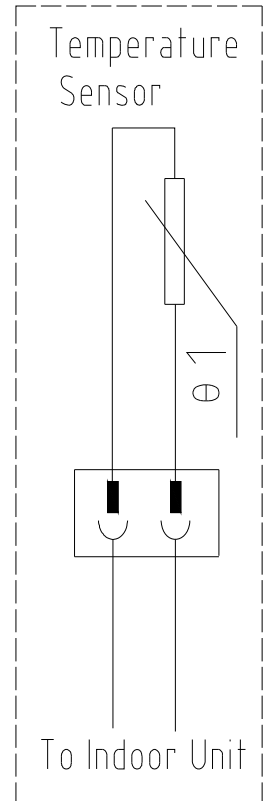
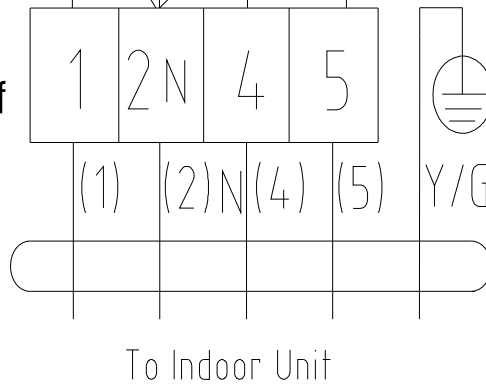

Intelligent Defrost Unit have no Temperature Sensor







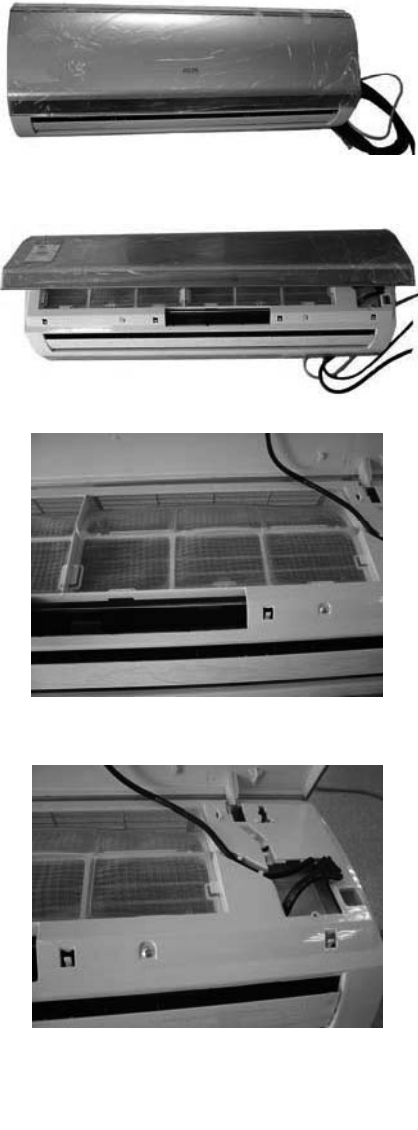

## Chapter 7 Disassembly & Assembly

### (1) Indoor unite and outdoor unit of 9000BTU~12000BTU

**Attention:** Turn off the air-conditioner and pull out the plug of the power supply before the service.

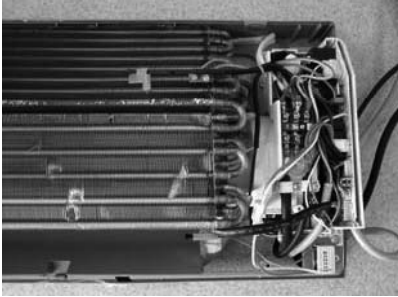
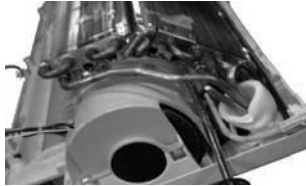

#### 1. Indoor unit:

No.	Part	Operation Process	Remark
1	Panel	1) Turn off the air-conditioner and cut off the power supply; 2) Tear the adhesive tape sticking to the panel;  3) Hold the handles at both sides of the panel and push upward to have it slip out; 4) Grasp the both sides of the panel and push upward; 5) Turn the upper board by 90° and unload it from the connecting pole carefully;  6) Take out the filter from the right and left side.  7) Screw off the bolts on the electrical box cover and unload the box cover;  8) Screw off the 5 bolts (for 1Hp AC) or 8 bolts (for 1.5Hp AC) on the medium frame; 9) Hold the both sides of the medium frame and open it gently 10) Turn up the medium frame by about 90°; 11) Offload the medium frame once hearing the crack sound;	
2	Electrical component	1) Do No."1" and "2" firstly, offload the water drainage soft tube; 2) Offload the water draining tank from chassis and take out the electrical components.	

3	Water draining tank	<p>1) Do No. "1" firstly;</p> <p>2) Pull out all tie-in connecting with PCB and the temperature sensor, etc.;</p> <p>3) Screw off the screws and bolts as indicated in the picture. Untie the outdoor unit's interconnection cord and power supply cord from the terminal of the electrical box.</p> <p>4) If the main PCB board is loosed by chance, remove it away;</p>	
4	Evaporator	<p>1) Do No."1" , "2" and "3" firstly;</p> <p>2) Offload the connecting pipe;</p> <p>3) Offload the tube clip at the rear;</p> <p>4) Screw off the bolts at the right and left side;</p> <p>5) Lift up the evaporator, and draw it out from the indoor unit;</p>	 
5	Indoor fan Fan motor	<p>1) Screw off one bolt from the motor cover, and remove the motor cover;</p> <p>2) Offload the motor from the fan;</p> <p>3) Offload the fan from bearing;</p>	  

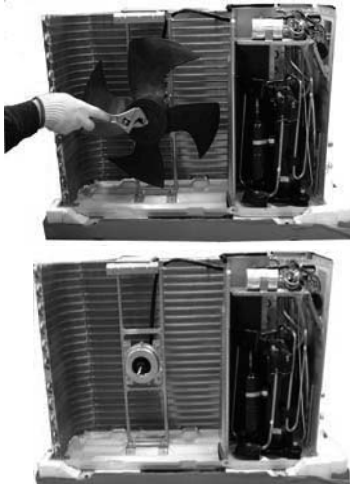
## 2. Outdoor unit:

No.	Part	Operation Process	Remark
1	General operation	<p>1) Screw off one fastening bolt from the electrical box cover, and offload the box cover;</p> <p>2) Pull out the interconnection cord from the electrical box;</p> <p>3) Screw off the five fastening bolts from the cover board, and offload the board; Screw the six fastening bolts from the front panel, and offload the front panel;</p> <p>4) Screw off the fastening bolts from the electrical assembly;</p> <p>5) Screw off the eight fastening bolts and offload the outer frame;</p>	
2	Outdoor fan motor	<p>1) Do No. "1" firstly;</p> <p>2) Screw off the fastenings screws clockwise.</p> <p>3) Offload the fan.</p> <p>4) Screw off the four fastening bolts and offload the fan motor;</p> <p>5) Screw off the two fastening bolts and offload the fan motor bracket.</p>	

3	Condenser	<ol style="list-style-type: none"> <li>1) Do No."1" and "2" firstly;</li> <li>2) Screw off the two fastening bolts;</li> <li>3) Weld off the inlet and outlet tube;</li> <li>4) Offload the condenser.</li> </ol>	
4	Compressor	<ol style="list-style-type: none"> <li>1) Do No."1" , "2"and "3" firstly;</li> <li>2) Open the cover of compressor, release the connection cord.</li> <li>3) Weld off the inlet and outlet tube;</li> <li>4) Screw off the three screws;</li> <li>5) Offload the compressor.</li> </ol>	

## Chapter 8 Troubleshooting Guide

### 8.1 Error Code

No.	Error Code	Problem
1	E1	Temperature sensor of air intake fault
2	E2	Temperature sensor of outdoor coil fault
3	E3	Temperature sensor of indoor coil fault
4	E4	PG motor of indoor unit feedback fault

### 8.2 Troubleshooting Guide for 09-12K

#### 1. The Foremost Inspecting Items

(1)The input voltage must be within +10% tolerance of the rated Voltage. If it is not the case, the air-conditioner will probably not work normally.

(2)Check the connecting cord between indoor unit and outdoor unit to see if it is properly connected. The connecting must be done according to the wiring diagram, please also notice that even different models may have the connecting cord of the same specification.

Please check if the marks at the connecting terminal and the marks on the cord can match, otherwise, the air-conditioner will not work normally.

(3)If the following phenomena are found, the problem is not from the air-conditioner itself.

<b>NO.</b>	<b>Problems</b>	<b>Causes</b>
1	The motor is heard operating but the air-conditioner dose not work when the indoor unit is powered on	Since the air-conditioner is powered on, it will come to working condition as long as you press the ON/OFF button of the remote control and the Signal is well received.
2	The compressor stops running but the indoor fan motor keeps working when it is at cooling mode with the indoor temperature higher than set temperature.	If you turn off the air-conditioner and restart it immediatly, it will return to normal in 3 minutes, after that, the air-conditioner will automatically adjust the indoor fan speed to what you set.
3	The compressor works discontinuously at dehumidifying mode.	The air-conditioner will automatically control the working of the compressor according to the inside temperature
4	The air-conditioner does not work while the LED display is on.	The TIMER is set with the air-conditioner; it will be in hold on condition. If the TIMER setting is cancelled, the air-conditioner will return to normal working condition
5	The compressor works discontinuously at cooling and dehumidifying mode, and the indoor fan motor slows down.	The compressor stops internally or the fan motor slows down to prevent the indoor heat exchanger from being frozen.

## 2. No Power Display

(1) Items

- a) Check if the input voltage is correct?
- b) Check if the AC power supply connecting is correct?
- c) Check if the output voltage of the manostat L7805 (IC2) is correct?

(2) Trouble shooting procedure

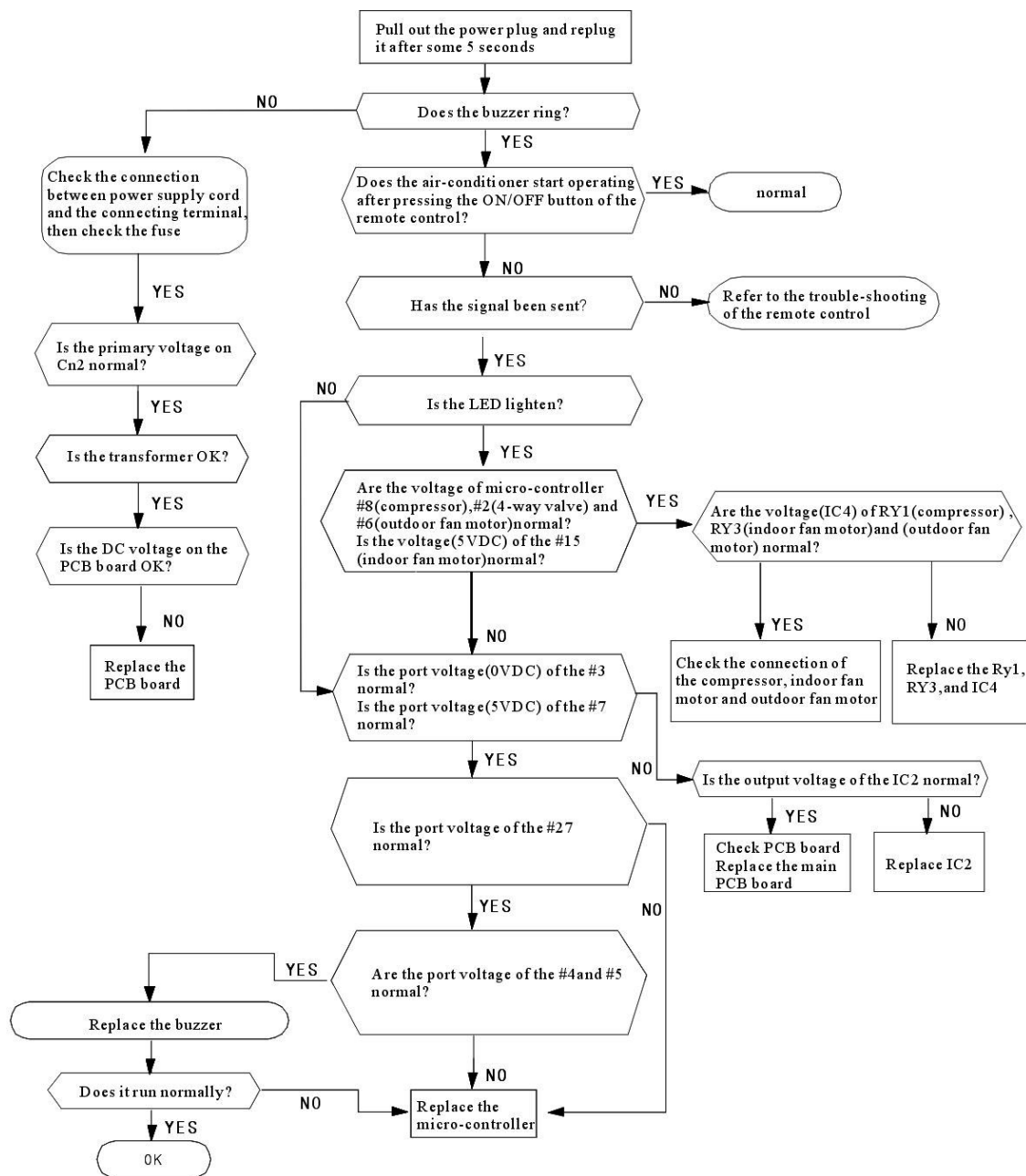

### 3. The Indoor Fan Motor Does Not Work

(1) Items

a) Check if the indoor fan motor is connected correctly to the connector (CN8)?

b) Check if the AC input voltage is correct?

c) Check if the IC of indoor fan motor is connected correctly to the connector (CN2)?

d) Check if the capacity of indoor fan motor is connected correctly to the connector (CN8)?

(2) Trouble shooting procedure

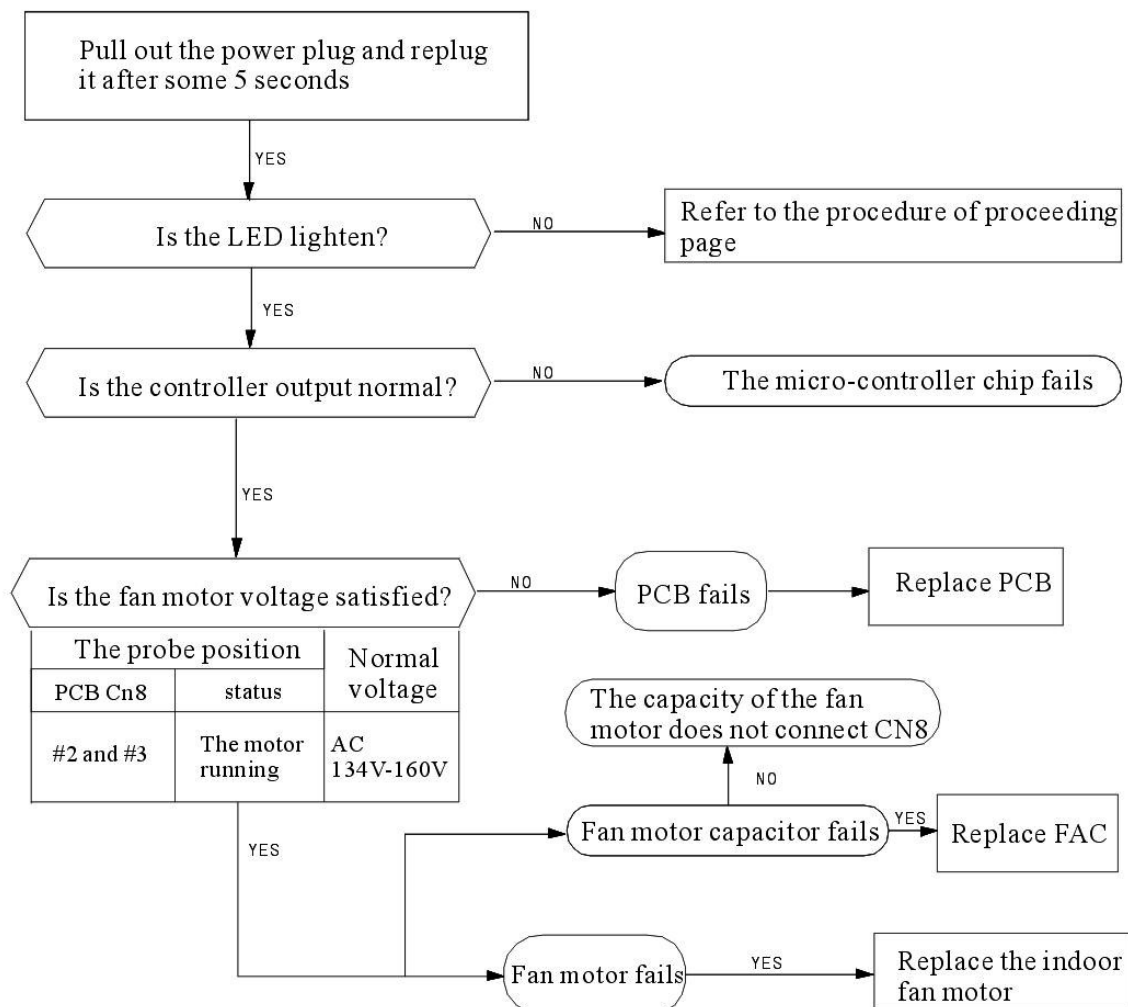



## 4. The Outdoor Unit Does Not Work

(1) Items

- a) Check if the input voltage is correct?
- b) Check if the wire connection of the outdoor connecting terminal is correct?

(2) Trouble shooting procedure

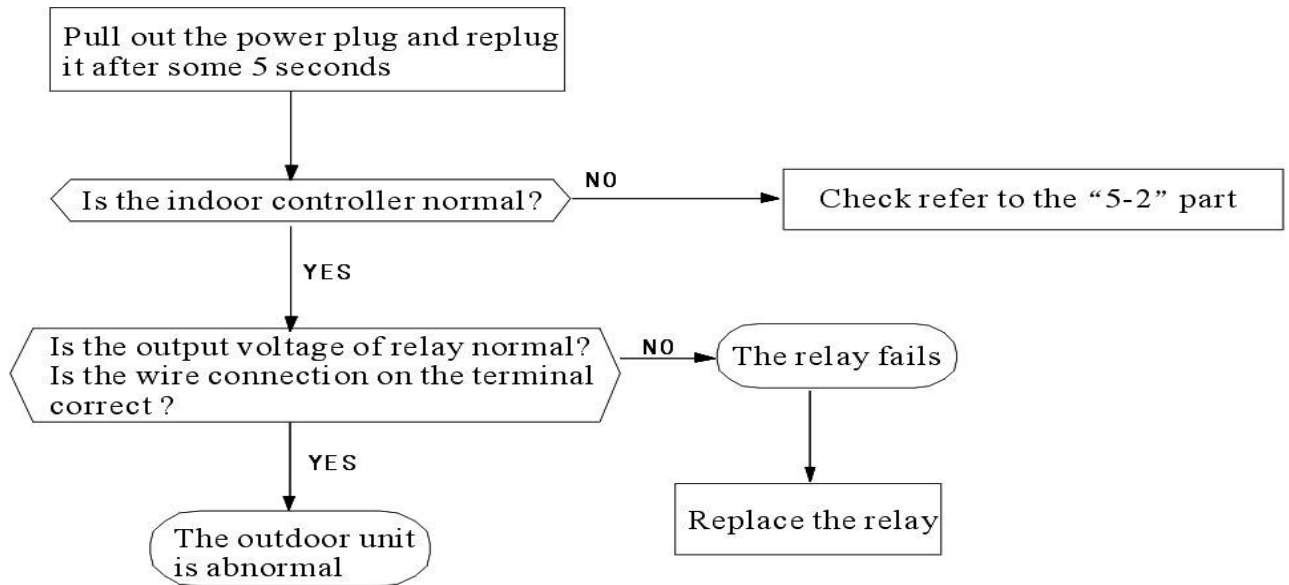

## 5. The Step Motor Does Not Work

(1) Items

a) Check if the input voltage is correct?

b) Check if the step motor controlling the up-down movement firmly connected to Cn2?

(2) Trouble shooting procedure

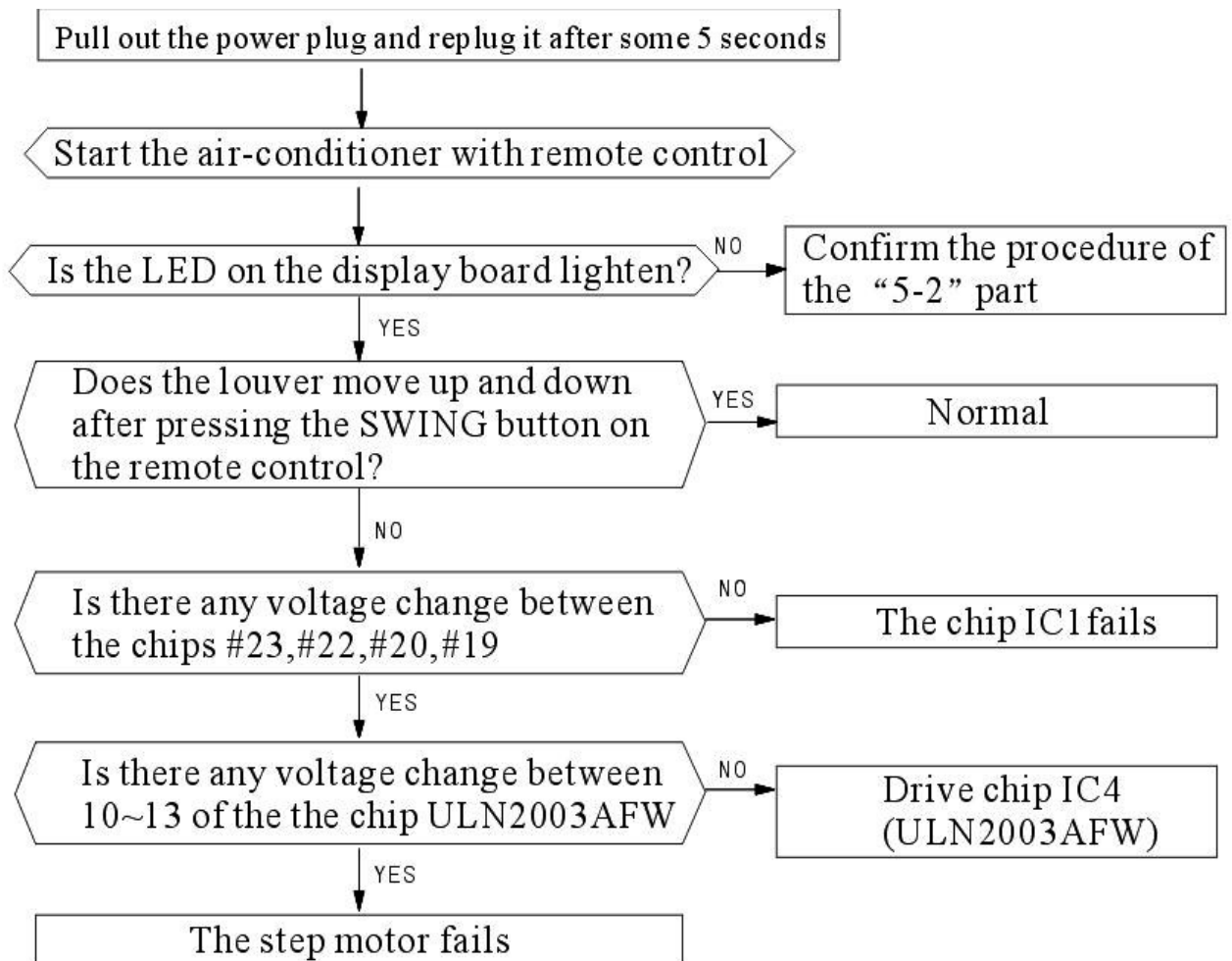

## 6. Heating Mode Can Work, But No Hot Air Blow

(1) Check if the set temperature is lower than the indoor temperature?

(2) Check if the indoor PCB is connected to the terminal correctly?

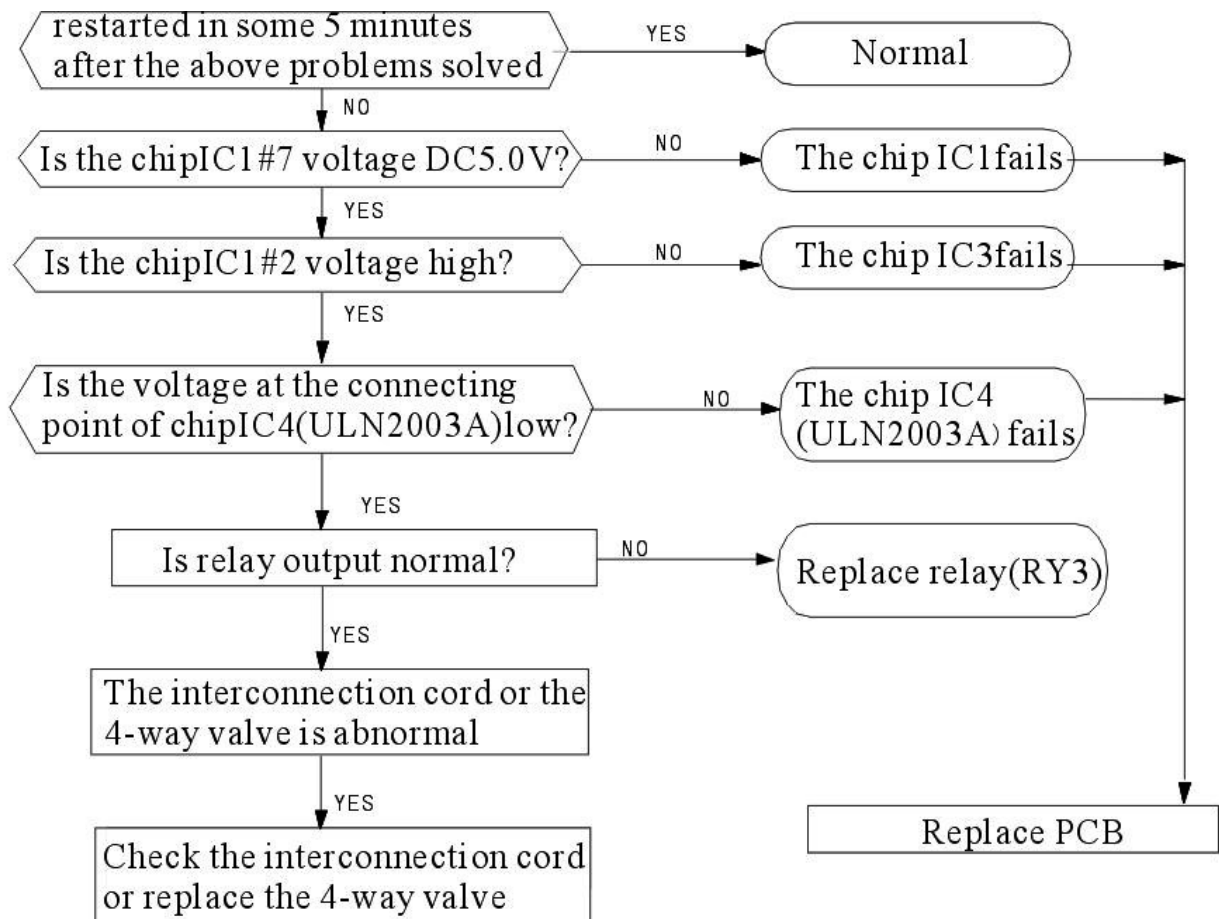

## 7. Remote Control Can Not Work

Trouble shooting procedure

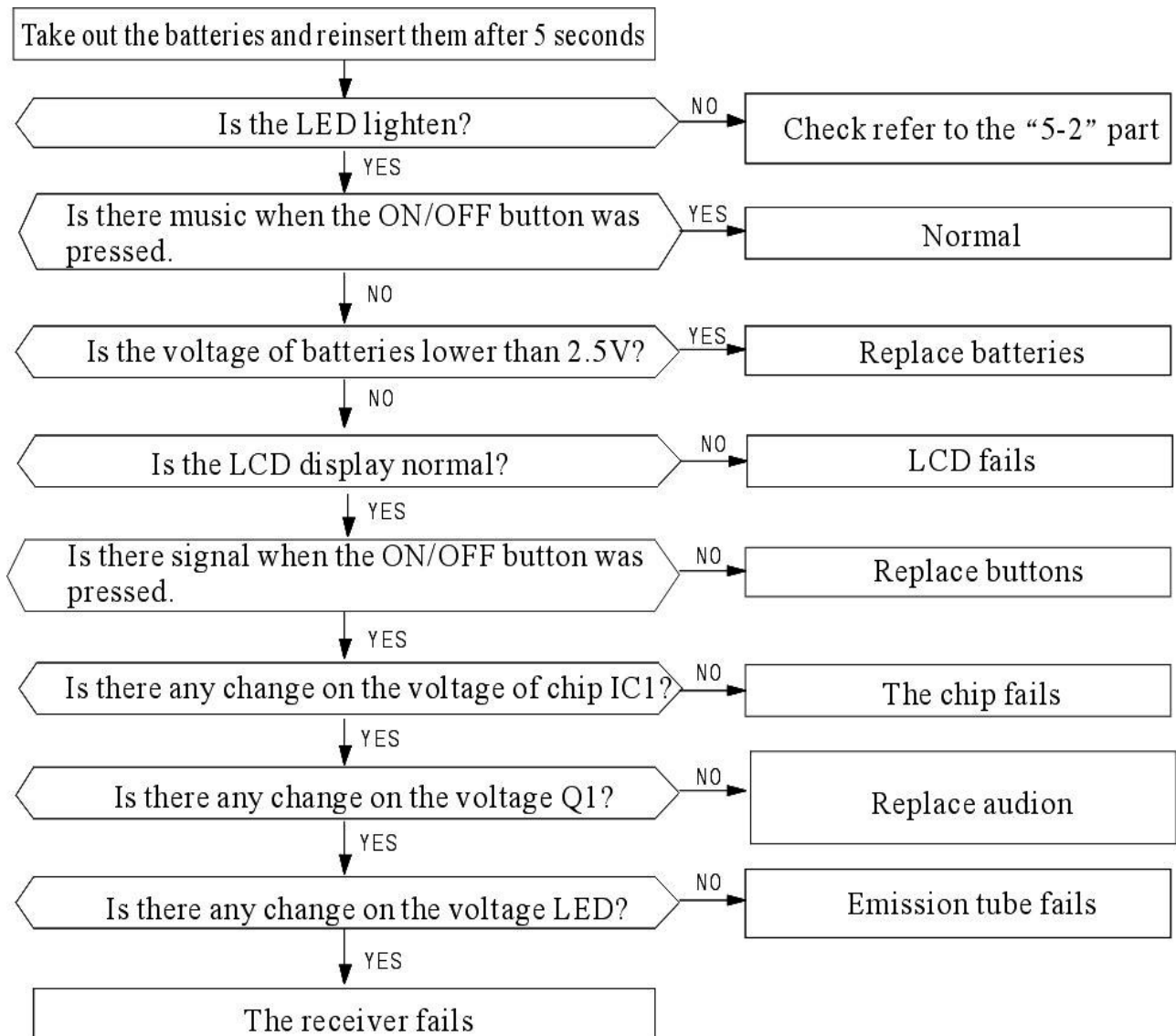

## 8. The Failure Analysis of the Main Parts

Part	Analysis																										
Heat exchanger	Measure resistance																										
	Normal	<table border="1"> <thead> <tr> <th>Environment temperature</th> <th>15℃</th> <th>20℃</th> <th>25℃</th> <th>30℃</th> <th>35℃</th> <th>40℃</th> </tr> </thead> <tbody> <tr> <td>Resistance of transformer(KΩ)</td> <td>7.45</td> <td>6.08</td> <td>5</td> <td>4.13</td> <td>3.43</td> <td>2.86</td> </tr> </tbody> </table>	Environment temperature	15℃	20℃	25℃	30℃	35℃	40℃	Resistance of transformer(KΩ)	7.45	6.08	5	4.13	3.43	2.86											
		Environment temperature	15℃	20℃	25℃	30℃	35℃	40℃																			
Resistance of transformer(KΩ)	7.45	6.08	5	4.13	3.43	2.86																					
Abnormal	∞ : Turn-off ; 0Ω : Short-cut																										
The indoor fan motor	Detecting the resistance between each connecting terminal																										
	Normal	Environment temperature (10℃ ~30℃ ) <table border="1"> <thead> <tr> <th colspan="2">Between</th> <th>1</th> <th>2</th> <th>3</th> </tr> </thead> <tbody> <tr> <td>Blue、yellow</td> <td>Main</td> <td>410Ω ±10%</td> <td>350Ω ±10%</td> <td>370Ω ±10%</td> </tr> <tr> <td>Blue、red</td> <td>Auxiliary</td> <td>325Ω ±10%</td> <td>270Ω ±10%</td> <td>300Ω ±10%</td> </tr> <tr> <td colspan="2">Input</td> <td colspan="3">YYK13-4: 13W YYK19-4: 19W</td> </tr> </tbody> </table>	Between		1	2	3	Blue、yellow	Main	410Ω ±10%	350Ω ±10%	370Ω ±10%	Blue、red	Auxiliary	325Ω ±10%	270Ω ±10%	300Ω ±10%	Input		YYK13-4: 13W YYK19-4: 19W							
		Between		1	2	3																					
		Blue、yellow	Main	410Ω ±10%	350Ω ±10%	370Ω ±10%																					
		Blue、red	Auxiliary	325Ω ±10%	270Ω ±10%	300Ω ±10%																					
Input		YYK13-4: 13W YYK19-4: 19W																									
Abnormal	∞ : Turn-off ; 0Ω : Short-cut																										
Detecting the voltage between the signal wire of fan motor and ground																											
Normal	<table border="1"> <thead> <tr> <th>Between</th> <th>Voltage</th> </tr> </thead> <tbody> <tr> <td>Gray、Orange</td> <td>0.5V~4.5V</td> </tr> <tr> <td>Yellow、Orange</td> <td>5V</td> </tr> </tbody> </table>	Between	Voltage	Gray、Orange	0.5V~4.5V	Yellow、Orange	5V																				
Between	Voltage																										
Gray、Orange	0.5V~4.5V																										
Yellow、Orange	5V																										
Abnormal	voltage<0, voltage>5 is abnormal																										
Step motor	Normal	Environment temperature (10℃ ~30℃ ) <table border="1"> <thead> <tr> <th colspan="2">Between</th> <th>1</th> <th>2</th> <th>-</th> </tr> </thead> <tbody> <tr> <td colspan="2"></td> <td>24BYJ48</td> <td>35BYJ412B</td> <td>-</td> </tr> <tr> <td>Blue、yellow</td> <td>-</td> <td>Above 300Ω</td> <td>Around 120Ω</td> <td>-</td> </tr> <tr> <td>-</td> <td>-</td> <td>-</td> <td>-</td> <td>-</td> </tr> <tr> <td colspan="2">Input</td> <td>1.5W</td> <td>-</td> <td>-</td> </tr> </tbody> </table>	Between		1	2	-			24BYJ48	35BYJ412B	-	Blue、yellow	-	Above 300Ω	Around 120Ω	-	-	-	-	-	-	Input		1.5W	-	-
		Between		1	2	-																					
				24BYJ48	35BYJ412B	-																					
Blue、yellow		-	Above 300Ω	Around 120Ω	-																						
-	-	-	-	-																							
Input		1.5W	-	-																							
Abnormal	∞ : Turn-off ; 0Ω : Short-cut																										
The outdoor fan motor	Detecting the resistance between the red wire and every connecting end																										
	Normal	When the temperature is20℃ ~30℃ ,around 300Ω and 120Ω																									
	Abnormal	∞ : Turn-off ; 0Ω : Short-cut																									

# Chapter 9 Exploded Views & Part List

(1) Indoor unit exploded picture (09-12K BTU, S Series)

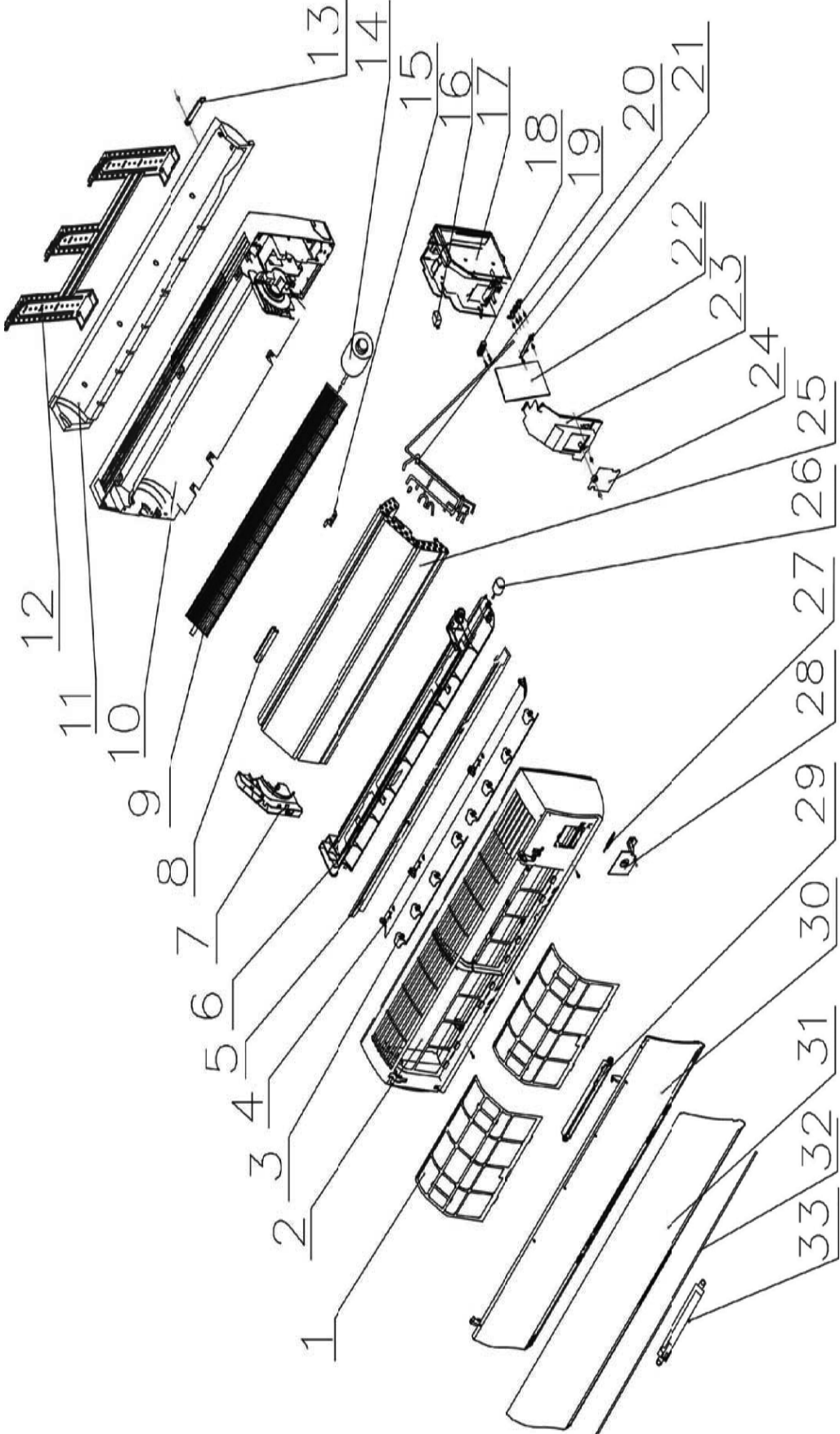

### INDOOR UNIT LIST

NO.	Name	Name	Quantity
1	过滤网	Filter	2
2	中框	Medium frame	1
3	导风叶片	Vertical air-blade	8
4	导风门	Horizontal air-blade	1
5	导风架泡沫	Foam of air blade holder	1
6	导风架	Air-vent holder	1
7	蒸发器支架	Left plastic-crutch for evaporator	1
8	底座盖板	Cover of chassis	2
9	贯流风叶	Through-flow fan	1
10	底座	Chassis	1
11	底座泡沫	Chassis foam	1
12	挂板	Mounting plate	1
13	管路压攀	Pipe clamp	1
14	塑封电机	Indoor fan motor	1
15	滑块	Slip block	3
16	变压器	Transformer	1
17	电控盒	Electric controller box	1
18	端子板	Terminal board	1
19	压线板	Wire clamp	1
20	蒸发器配管	Evaporator tubing assembly	1
21	遥控器接收座	Signal receiver holder for remote controller	1
22	主控板	Main PCB	1
23	电控盒上盖	Cover of electric controller box	1
24	接线盖	Top cover of electric controller box	1
25	蒸发器	Evaporator	1
26	步进电机	Step motor	1
27	接受窗	Receiver window for remote controller	1
28	电控盒盖	Cover of medium frame	1
29	显示灯座	Indication lamp holder	1
30	面板衬板	Panel scaleboard	1
31	面板	Panel	1
32	镜面装饰板	Panel ornamental board	1
33	显示灯板	Display board	1

**(2) Outdoor unit exploded picture (09-12K BTU, S Series)**

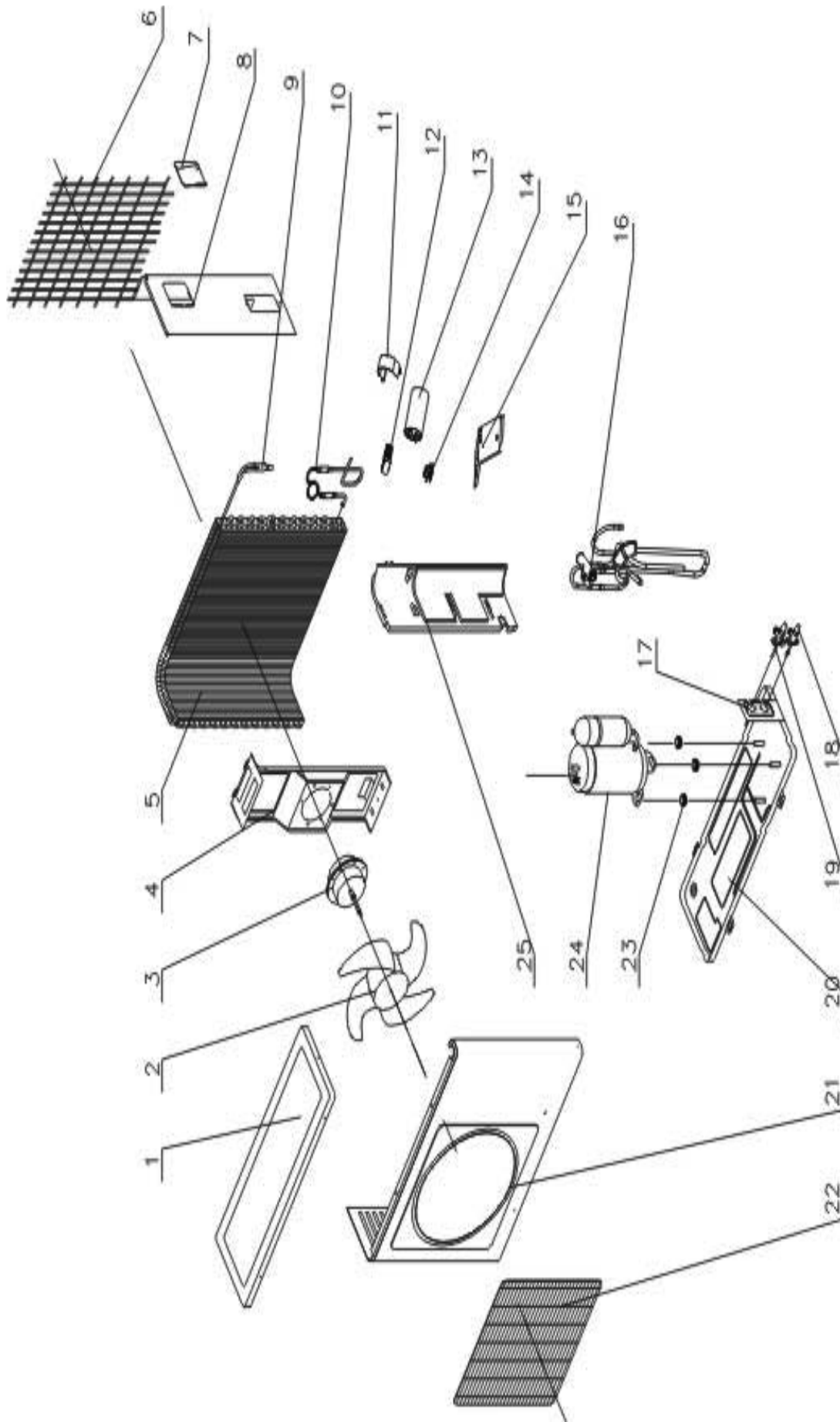



OUTDOOR UNIT LIST

No.	Name	Name	Quantity
1	顶盖板	Top cover board	1
2	轴流风扇	Axial-flow fan	1
3	风扇电机	Fan motor	1
4	电机支架	Motor bracket	1
5	冷凝器组件	Condenser assembly	1
6	防护网罩	Defense net	1
7	电器盖板	Handle	1
8	右侧板	Right side plate	1
9	三通铜管	Three way copper pipe	1
10	毛细管组件	Capillary assembly	1
11	电容抱攀	Capacitor clamp	1
12	五位端子板	Terminal board	1
13	压缩机电容	Compressor capacitor	1
14	压线板	Wire clamp	1
15	电器架	Electricity board	1
16	四通阀管路组件	Four-way valve assembly	1
17	阀板	Valve plate	1
18	高压阀组件 Dg4	Liquid valve assembly	1
19	低压阀组件 Dg8- I	Gas valve assembly	1
20	底盘组件	Chassis assembly	1
21	面板	Panel	1
22	出风网罩	Air-outlet net	1
23	压缩机减震块	Compressor shock absorber washer	3
24	压缩机	Compressor	1
25	隔风立板	Partition plate	1

# Chapter 10 Operation Details

## Summarization

This specification is used for E、 Q、 SA series whose capacity is 12000 btu and lower one, this standard book include all of the functions of 12000 btu and lower styles , but to the single unit , it not always all of the functions, the specific functions need to correspond corresponding modes to decide, this specification's contents include same parts as below:

- 1、 the basic condition of electrical control using
- 2、 partition of electrical controller's function
- 3、 description of main functions
- 4、 technique index and demand

The products must conform this specification's technique index and demand, what do not conform to this specification should be sentenced to as nonconforming product

### **The basic condition of electrical control using**

- 1、 the suitable scope of electricity and voltage: input voltage 175V~253V;
- 2、 alternating current input voltage frequency: 50Hz;
- 3、 environment temperature of electronic control working: (-10~+70)°C;
- 4、 environment humidity of electronic control working: RH20%~RH90%;
- 5、 indoor fan for the PG plastic motor , three-pulse feedback signal;
- 6、 outdoor fan for the tap steel shell motor, first files is wind speed, the

normal working electricity less than 1.5A;

7、 the four-way valve working electricity less than 1A/220V;

8、 the swing motor is DC12V, four-phase eight clap step motor ;

9、 the compressor is single power, the normal working electricity less than 1.5A;

### **partition of electrical control's function**

controller's function constitute by some parts below:

- 1、 remote control receive function
- 2、 display function
- 3、 forced running function
- 4、 indoor fan's air blade automatic swing and location setting function
- 5、 buzzer drive function
- 6、 indoor fan drive function
- 7、 timer ON/OFF function
- 8、 compressor three minutes delayed protect function
- 9、 under heating mode, the indoor heat exchanger high temperature protect function
- 10、 under the heating mode, automatic defrost function and recover heating function
- 11、 under the heating mode, prevent cold wind function
- 12、 under cooling、 drying mode, prevent freeze function

### 13、 self-test function

## **Main function instruction**

### **1、 proper noun and expression**

TA: indoor environment temperature

TE: indoor evaporator temperature

TS: setting temperature

### **2、 mandatory switch**

when the air conditioner under the opening condition, press this button is closing phenomenon; when the air conditioner under the closing condition ,press this is opening phenomenon, and after opening by press this button ,the air conditioner operation under the automatic mode, the operation light flicker 20s, operation after the system designate the operation mode; the air conditioner according to the indoor temperature automatic choose cooling 、 drying 、 heating modes to operation.

### **3、 automatic mode**

when the remote controller choose the automatic mode, the operation light flicker 20s after opening and operation after the system designate the operation mode; the air conditioner according to the indoor temperature automatic choose cooling 、 drying 、 heating modes to operation.

#### **4、cooling mode**

setting the temperature by remote controller, the control scope of temperature is 16°C~32°C, press the “up”、 “down” button can adjust the temperature. Press the “wind speed choose” button can choose the automatic wind、 high speed wind、 middle speed wind、 low speed wind. Under this mode ,the four-way valve closed.

#### **5、drying mode**

under this mode ,the four-way valve always closed, the control scope of temperature is 16°C~32°C.

#### **6、ventilation mode**

under this mode, the outdoor conditioner always closed, indoor fan operation under the setting wind speed, the remote controller can choose high speed wind、 middle speed wind、 low speed wind, no automatic wind; the wind door operation condition same with cooling mode; there have timer 、 power off memory(reserved) 、 anion(reserved)function.

#### **7、heating mode**

setting the temperature by remote controller, the control scope of temperature is 16°C~32°C. press the “up”、 “down” button can adjust the temperature. Press the “wind speed choose” button can choose the automatic wind、 high speed wind、 middle speed wind、 low speed wind

#### **8、online detection of electric heating function**

when the heating mode normal operation, the compressor start、 outdoor fan operation、 valve circuit have power、 indoor fan open, and when satisfy the condition in the same time, the electric heating open.

## **9、 intelligent defrost function**

When this mode operation , the conditioner begin to defrost if satisfy the condition, the sleeping light flicker.

## **10、 sleep control function**

when automatic、 cooling、 drying、 heating operation, the sleeping function effective, after enter the sleeping, the indoor fan wind speed automatic reduce one files, sleeping light lighten.

Press “sleep” button enter into sleeping operation, for the cooling operation, the setting temperature automatic rise 1℃ after 1h; for the heating operation, the setting temperature drop 2℃ after 1h, for the cooling operation, the setting temperature rise 1℃ again; for the heating operation, the setting temperature drop 2℃ again. The sleeping mode closed after 7h.

After enter the sleeping operation:

- ① mode change effective, but after change the mode, the sleeping function cancel
- ② if press “warming” button, the air conditioner will according “new setting temperature+ revise temperature” to operation.

Under the sleeping condition, press the “sleep” button again、 mode

choose button or close, the sleeping cancel, finish the sleeping operation.

### Cooling operation sleeping:

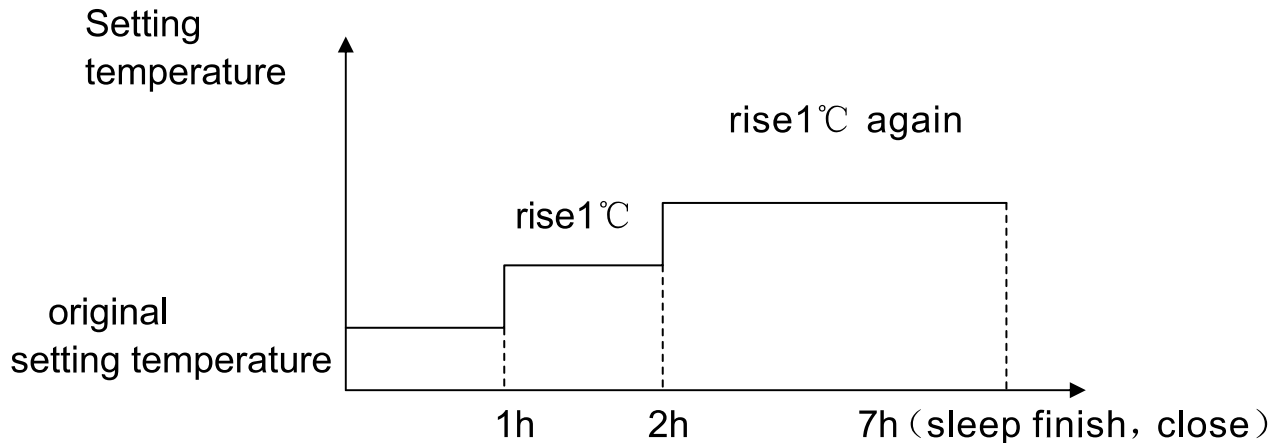

### Heating operation sleeping:

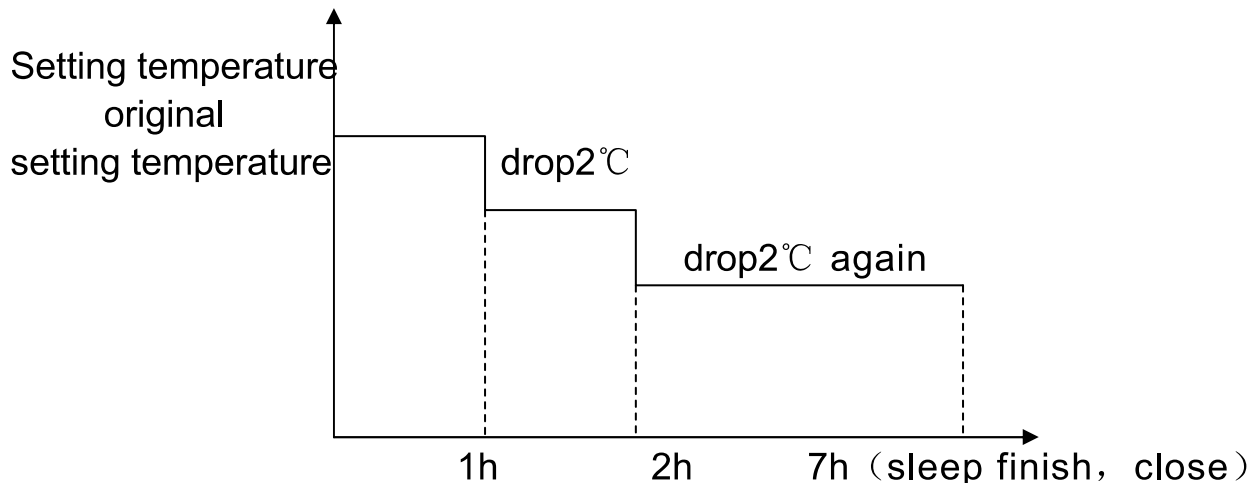

## 11、 timing control function

The longest timing time is 24h, unit is 1min, single timing way, change the mode not cancel the timing function, after setting the timing mode, pointing light lighten.

### ① Setting the “off” timer time

Just setting under condition of air conditioner operation, the timing scope is 1min~12h, divide 12h a.m. and 12h p.m., when arriver the

setting time, the conditioner automatic close.

③ Setting the “on” timer time

Just setting under condition of the air conditioner closed, the timing scope is 1min~12h, divide 12h a.m. and 12h p.m., when arriver the setting time, the conditioner automatic open.

Open or close the conditioner after setting timing, the intrinsic timing and sleeping automatic cancel.

Note: the sleeping and timing function can setting in the same time, when two functions setting in the same time, function of time for which the implementation of the first functions to be.

**13、 fault indication**

When the air conditioner breakdown, the nixie tube on the remote controller light board or LED light will according different fault to point homologous fault code, the detailed as follow:

Reason of fault	Way of display	phenomenon
PG feedback unusual	display“E4”or timing light flicker 4times or 8s	Closing down
TA unusual(open or short circuit)	display“E1” or timing light flicker 1times or 8s	Closing down
TE unusual(open or short circuit)	display“E3” or timing light flicker 3times or 8s	Closing down
Full-machine	display“E6” or timing light flicker	Closing down



electricity protect	6times or 8s	
---------------------	--------------	--

Note: the nixie tube just display homologous fault code, if not have the nixie tube and just have the timing light, so the timing light point homologous fault code.

When the indoor fan motor add the voltage, if not detection pulse signal which feedback by the indoor fan motor, close the output voltage of power supply to the indoor fan motor on the remote controller , after standby 30s, offer the voltage to the indoor fan motor again, if also not detection pulse signal which feedback by the indoor fan motor in 10s, so the remote controller enter into the standby condition, meanwhile, the nixie tube display the homologous fault code E4 , this moment, close the conditioner by remote controller, so the fault display relieve.

## **20、 automatic cleaning function**

This function as a special function, just can use under the closing condition, as long as the users choose this function, the full-machine procedure setting mode automatic operation, after operation automatic cleaning, the air conditioner operation according to the remote controller's require(close or timing open).

# Chapter 11 Current & Diagram of PCB

3.1

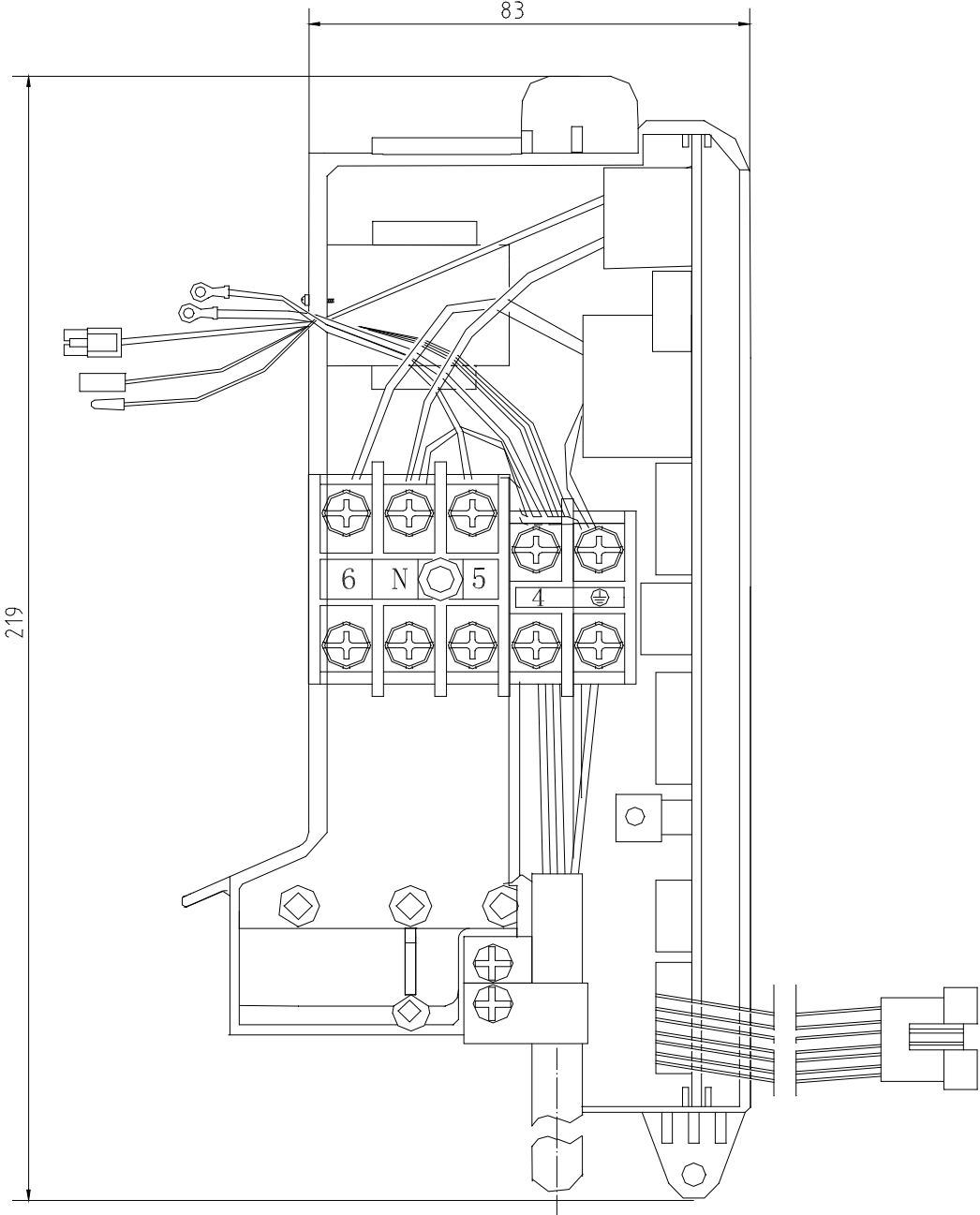

3.2

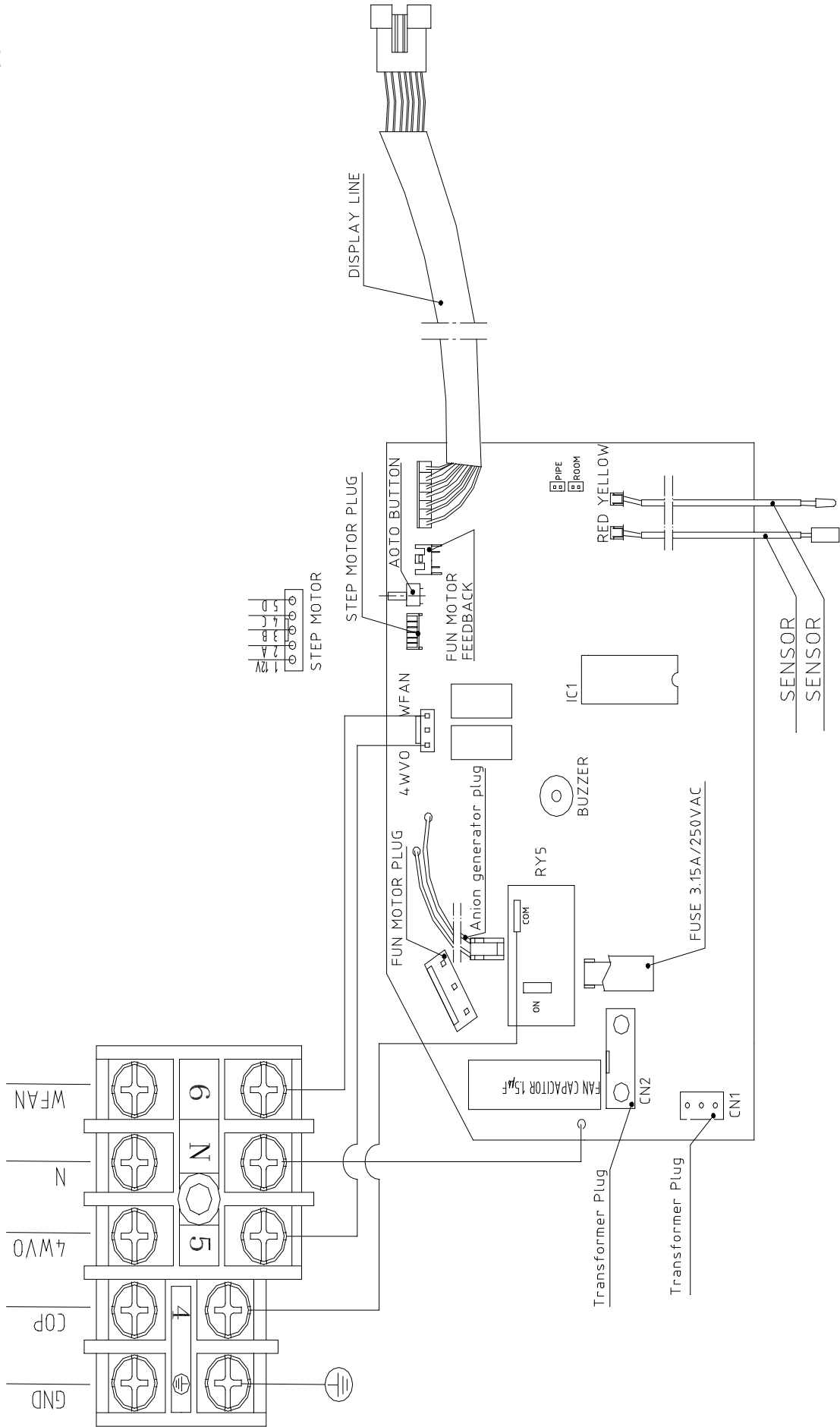

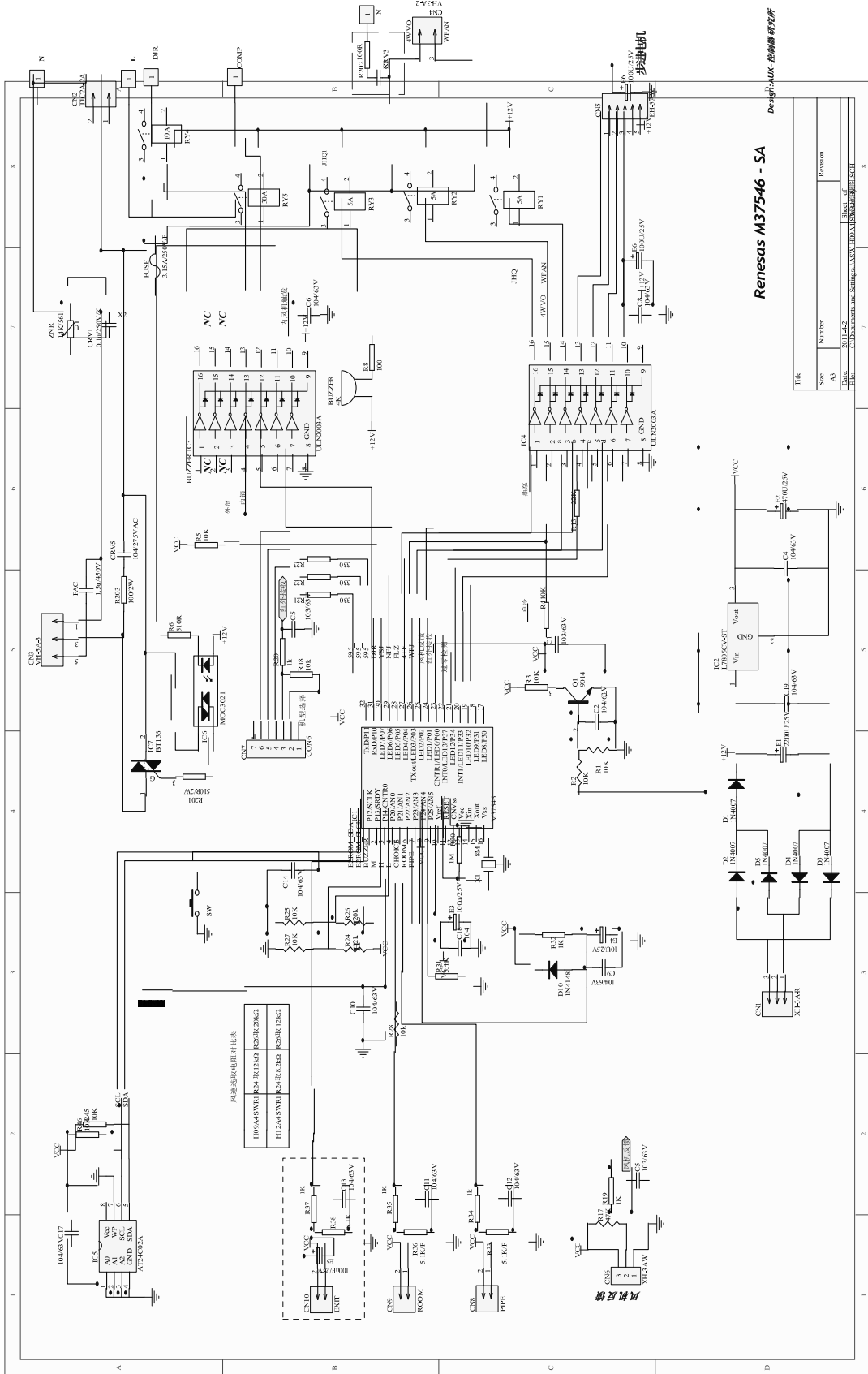

Renesas M37546 - SA

Design: AOK-控制部研究科

File	Size	Number	Revision
M37546	45		
Doc	2014-02		
File	C:\Documents and Settings\Administrator\Desktop\SA\PCB\M37546_SCH1		Sheet of 8

