

# Airwell

# Service Manual

## HGF / HHF Series

---

Indoor Units		Outdoor Units
AWSI-HGF009-H11	AWSI-HHF009-H11	AWAU-YGF009-H11
AWSI-HGF012-H11	AWSI-HHF012-H11	AWAU-YGF012-H11
AWSI-HGF018-H11	AWSI-HHF018-H11	AWAU-YGF018-H11
AWSI-HGF024-H11	AWSI-HHF024-H11	AWAU-YGF024-H11



---

REFRIGERANT

R410A

HEAT PUMP

SM HGFHHF 1-A.1 GB

March- 2011

Version:2

LIST OF EFFECTIVE PAGES

**Note:** Changes in the pages are indicated by a “Revision#” in the footer of each effected page (when none indicates no changes in the relevant page). All pages in the following list represent effected/ non effected pages divided by chapters.

Dates of issue for original and changed pages are:

Original ..... 01 ..... 27 Dec, 10  
 Updated..... 02 ..... 04 Mar, 11

Total number of pages in this publication is **75** consisting of the following:

Page No.	Revision No. #	Page No.	Revision No. #	Page No.	Revision No. #
Title.....	1				
A .....	1				
i.....	1				
1-1 - 1-4.....	1				
2-1 - 2-4.....	1				
3-1.....	1				
4-1 - 4-2.....	1				
5-1 - 5-10.....	1				
6-1 - 6-4.....	1				
7-1 - 7-1.....	1				
8-1 - 8-4.....	1				
9-1.....	1				
10-1.....	1				
11-1 - 11-8.....	1				
12-1 - 12-2.....	1				
13-1 - 13-18.....	1				
14-1.....	1				

\* Zero in this column indicates an original page.

---

## Table of Contents

1.	INTRODUCTION .....	1-1
2.	PRODUCT DATA SHEET .....	2-1
3.	RATING CONDITIONS .....	3-1
4.	OUTLINE DIMENSION .....	4-1
5.	PERFORMANCE DATA .....	5-1
6.	SOUND LEVEL CHARACTERISTICS .....	6-1
7.	ELECTRICAL DATA .....	7-1
8.	WIRING DIAGRAM .....	8-1
9.	REFRIGERATION DIAGRAMS .....	9-1
10.	TUBING CONNECTIONS .....	10-1
11.	CONTROL SYSTEM .....	11-1
12.	TROUBLESHOOTING .....	12-1
13.	EXPLODED VIEW & SPARE PART LIST .....	13-1
14.	APPEDDIX .....	14-1

## 1. INTRODUCTION

### 1.1 General

HGF/HHF/YGF series is monosplit fixed speed air conditioner designed for residential buildings. The IDU HGF/HHF is a high-wall mounted type indoor with modern appearance. Following models are included:

- AWSI-HGF009-H11 / AWSI-HHF009-H11 // AWAU-YGF009-H11
- AWSI-HGF012-H11 / AWSI-HHF012-H11 // AWAU-YGF012-H11
- AWSI-HGF018-H11 / AWSI-HHF018-H11 // AWAU-YGF018-H11
- AWSI-HGF024-H11 / AWSI-HHF024-H11 // AWAU-YGF024-H11

Different appearance styles are used in HGF and HHF indoors.

### 1.2 Main Features

The unit benefits from the most advanced technological innovations, namely:

- R410A models
- Microprocessor control and indoor LED display
- Energy efficiency class A in cooling mode for all models
- Max allowing tubing distance of 25m.(For model HGF/HHF018-024)
- Up to 10 m vertical high between indoor and outdoor units
- Cooling operation at outdoor temperature up to 46°C.
- Easy installation and service.
- Sleep mode from remote control to save energy
- ON/OFF timer and clock display
- Vertical auto swing with motorized flap (any position stop)
- Intelligent Deicing
- Memory from power failure
- Rapid cooling/heating
- I-Feel function
- Cold air prevention in heating
- Clean function (Blow dry)
- Self diagnostic (Error indications) for ease of maintenance

### 1.3 Indoor Unit

The indoor unit is wall mounted, and can be easily fitted to many types of residential locations. It includes:

- LED display
- Variable speed with PG motor
- Motorized flap
- High efficiency filtration to ensure a best Air Quality : Advanced filtering combine mechanical, Photo-catalytic + Bi-anti bacterial and observe bad gaseous and smokes.

### 1.4 Control

The microprocessor indoor controller, and an infrared remote control, supplied as standard, provide complete operating function and programming.

Remote control RC 8:

Compact and economically design, it offers excellent user comfort. Combining modern design with high technology, the RC8 remote control offers powerful functions of real considering of user comfort and energy saving of air-conditioner .

For detail of functions, please refer to Appendix 1

## 1.5 Outdoor Unit

The outdoor units can be installed as floor or wall mounted units by using a wall supporting bracket. The metal sheets are protected by anti- corrosion paint work allowing long life resistance. All outdoor units are pre-charged. For further information please refer to the Product Data Sheet, Chapter 2.

It includes :

- Compressor mounted in a soundproofed compartment :
- Axial fan.
- Outdoor coil with hydrophilic louver fins for RC units.
- Outlet air fan grill.
- Interconnecting wiring terminal block.





## 1.6 Tubing Connections

Flare type interconnecting tubing to be produced on site.  
For further details please refer to the Installation Manual.

## 1.7 Inbox Documentation

Each unit is supplied with its own installation, operation and remote control manuals.

1.8 Matching Table

OUTDOOR UNITS	INDOOR UNITS			
	AWSI-HGF009-H11	AWSI-HGF012-H11	AWSI-HGF018-H11	AWSI-HGF024-H11
	AWSI-HHF009-H11	AWSI-HHF012-H11	AWSI-HHF018-H11	AWSI-HHF024-H11
 AWAU-YGF009-H11	√			
 AWAU-YGF012-H11		√		
 AWAU-YGF018-H11			√	
 AWAU-YGF022-H11				√

## 2. PRODUCT DATA SHEET

### 2.1 HGF009 / HHF009 // YGF009

Model Indoor Unit				HGF009/HHF009	
Model Outdoor Unit				YGF009	
Installation Method of Pipe				Flared	
Characteristics		Units		Cooling	Heating
Capacity (4)		kW		2.64	2.81
Power input (4)		kW		0.82	0.78
EER (Cooling) or COP(Heating) (4)		W/W		3.21	3.61
Energy efficiency class				A	A
Power supply		V		220-240	
		Ph		1	
		Hz		50	
Rated current		A		3.8	3.6
Power factor				0.92	0.92
Prated (IDU+ODU)		W		1120	
Circuit breaker rating		A		10A	
INDOOR	Fan type & quantity		Crossflow x 1		
	Fan speeds	Cooling	SH/H/M/L	RPM	1390/1280/1180/1080
		Heating	SH/H/M/L	RPM	1350/1250/1140/1040
	Air flow (1)		SH/H/M/L	M3/hr	400/370/340/310
	External static pressure		Min	Pa	0
	Sound power level (2)		SH/H/M/L	dB(A)	50/47/45/42
	Sound pressure level(3)		SH/H/M/L	dB(A)	40/37/35/32
	Moisture removal			l/hr	1.0
	Condensate drain tube I.D			mm	16
	Dimensions		WxHxD	mm	730x255x174
	Net Weight			kg	8
	Package dimensions		WxHxD	mm	790x325x245
	Packaged weight			kg	10.5
	OUTDOOR	Refrigerant control		Capillary	
Compressor type, model		Rotary, Panasonic-5PS102EAA22			
Fan type & quantity		Propeller(direct) x 1			
Fan speeds		H	RPM	830	
Air flow		H	M3/hr	1500	
Sound power level		H	dB(A)	60	
Sound pressure level(3)		H	dB(A)	50	
Dimensions		WxHxD	mm	785x540x320	
Net Weight			kg	31	
Package dimensions		WxHxD	mm	820x580x355	
Packaged weight			kg	34	
Refrigerant type		R410A			
Standard charge			kg(4m)	0.76	
Additional charge			g/m	30g/m(4m<L<15m)	
Connections between units	Liquid line		In.(mm)	1/4"(6.35)	
	Suction line		In.(mm)	3/8"(9.53)	
	Max.tubing length		m.	Max. 15	
	Max.height difference		m.	Max. 10	
Operation control type				Remote control	

- (1)Airflow in ducted units; at nominal external static pressure.
- (2)Sound power in ducted units is measured at air discharge.
- (3)Sound pressure level measured at 1-meter distance from unit.
- (4)Rating conditions in accordance to ISO 5151 and ISO 13253 (for ducted units).



2.2 HGF012 / HHF012 // YGF012

Model Indoor Unit				HGF012/HHF012		
Model Outdoor Unit				YGF012		
Installation Method of Pipe				Flared		
<b>Characteristics</b>			<b>Units</b>	<b>Cooling</b>	<b>Heating</b>	
Capacity (4)			kW	3.22	3.52	
Power input (4)			kW	1.00	0.97	
EER (Cooling) or COP(Heating) (4)			W/W	3.21	3.61	
Energy efficiency class				A	A	
Power supply			V	220-240		
			Ph	1		
			Hz	50		
Rated current			A	4.7	4.6	
Power factor				0.92	0.92	
Prated (IDU+ODU)			W	1450		
Circuit breaker rating			A	16A		
INDOOR	Fan type & quantity				Crossflow x 1	
	Fan speeds	Cooling	SH/H/M/L	RPM	1350/1250/1100/950	
		Heating	SH/H/M/L	RPM	1350/1250/1100/950	
	Air flow (1)			SH/H/M/L	m3/hr	550/500/420/350
	External static pressure			Min	Pa	0
	Sound power level (2)			SH/H/M/L	dB(A)	50/48/45/42
	Sound pressure level(3)			SH/H/M/L	dB(A)	40/38/35/32
	Moisture removal				l/hr	1.0
	Condensate drain tube I.D				mm	16
	Dimensions		WxHxD	mm	790x265x177	
	Net Weight				kg	9
	Package dimensions		WxHxD	mm	870x355x248	
	Packaged weight				kg	12
	OUTDOOR	Refrigerant control				Capillary
Compressor type, model				Rotary, LANDA- QXA-B120C150		
Fan type & quantity				Propeller(direct) x 1		
Fan speeds		H	RPM	850		
Air flow		H	m3/hr	1800		
Sound power level		H	dB(A)	62		
Sound pressure level(3)		H	dB(A)	52		
Dimensions		WxHxD	mm	798x540x320		
Net Weight				kg	35	
Package dimensions		WxHxD	mm	825x580x355		
Packaged weight				kg	40	
Refrigerant type				R410A		
Standard charge			kg(4m)	0.76		
Additional charge			g/m	30g/m(4m<L<20m)		
Connections between units		Liquid line		In.(mm)	1/4"(6.35)	
		Suction line		In.(mm)	1/2"(12.7)	
	Max.tubing length		m.	Max. 20		
	Max.height difference		m.	Max. 10		
Operation control type					Remote control	

- (1)Airflow in ducted units; at nominal external static pressure.
- (2)Sound power in ducted units is measured at air discharge.
- (3)Sound pressure level measured at 1-meter distance from unit.
- (4)Rating conditions in accordance to ISO 5151 and ISO 13253 (for ducted units).

2.3 HGF018 / HHF018 // YGF018

Model Indoor Unit				HGF018/HHF018		
Model Outdoor Unit				YGF018		
Installation Method of Pipe				Flared		
Characteristics			Units	Cooling	Heating	
Capacity (4)			kW	5.30	5.70	
Power input (4)			kW	1.64	1.67	
EER (Cooling) or COP(Heating) (4)			W/W	3.23	3.41	
Energy efficiency class				A	B	
Power supply			V	220-240		
			Ph	1		
			Hz	50		
Rated current			A	7.8	7.9	
Power factor				0.92	0.92	
Prated (IDU+ODU)			W	2550		
Circuit breaker rating			A	25A		
INDOOR	Fan type & quantity				Crossflow x 1	
	Fan speeds	Cooling	SH/H/M/L	RPM	1350/1200/1050/900	
		Heating	SH/H/M/L	RPM	1350/1200/1050/900	
	Air flow (1)			SH/H/M/L	m3/hr	850/780/650/550
	External static pressure			Min	Pa	0
	Sound power level (2)			SH/H/M/L	dB(A)	58/55/52/48
	Sound pressure level(3)			SH/H/M/L	dB(A)	48/45/42/38
	Moisture removal				l/hr	3.0
	Condensate drain tube I.D				mm	16
	Dimensions		WxHxD	mm	940x298x200	
	Net Weight				kg	13
	Package dimensions		WxHxD	mm	1010x380x285	
	Packaged weight				kg	17
	OUTDOOR	Refrigerant control				Capillary
Compressor type, model				Rotary, HITACHI - ASH210SV-C8LU		
Fan type & quantity				Propeller(direct) x 1		
Fan speeds		H	RPM	860		
Air flow		H	m3/hr	2790		
Sound power level		H	dB(A)	64		
Sound pressure level(3)		H	dB(A)	54		
Dimensions		WxHxD	mm	913x680x378		
Net Weight				kg	46	
Package dimensions		WxHxD	mm	994x725x428		
Packaged weight				kg	50	
Refrigerant type				R410A		
Standard charge			kg(4m)	1.5		
Additional charge			g/m	30g/m(4m<L<25m)		
Connections between units	Liquid line		In.(mm)	1/4"(6.35)		
	Suction line		In.(mm)	1/2"(12.7)		
	Max.tubing length		m.	Max. 25		
	Max.height difference		m.	Max. 10		
Operation control type				Remote control		

- (1)Airflow in ducted units; at nominal external static pressure.
- (2)Sound power in ducted units is measured at air discharge.
- (3)Sound pressure level measured at 1-meter distance from unit.
- (4)Rating conditions in accordance to ISO 5151 and ISO 13253 (for ducted units).

2.4 HGF024/ HHF024 // YGF024

Model Indoor Unit				HGF024/HHF024		
Model Outdoor Unit				YGF024		
Installation Method of Pipe				Flared		
<b>Characteristics</b>		<b>Units</b>		<b>Cooling</b>	<b>Heating</b>	
Capacity (4)		kW		6.16	6.50	
Power input (4)		kW		1.90	1.90	
EER (Cooling) or COP(Heating) (4)		W/W		3.24	3.42	
Energy efficiency class				A	B	
Power supply		V		220-240		
		Ph		1		
		Hz		50		
Rated current		A		8.9	8.9	
Power factor				0.92	0.92	
Prated (IDU+ODU)		W		2700		
Circuit breaker rating		A		25A		
INDOOR	Fan type & quantity			Crossflow x 1		
	Fan speeds	Cooling	SH/H/M/L	RPM	1350/1200/1050/900	
		Heating	SH/H/M/L	RPM	1350/1200/1050/900	
	Air flow (1)			SH/H/M/L	m3/hr	850/780/650/550
	External static pressure			Min	Pa	0
	Sound power level (2)			SH/H/M/L	dB(A)	57/54/51/48
	Sound pressure level(3)			SH/H/M/L	dB(A)	47/44/41/38
	Moisture removal				l/hr	3.0
	Condensate drain tube I.D				mm	16
	Dimensions		WxHxD	mm	940x298x200	
	Net Weight				kg	13
	Package dimensions		WxHxD	mm	1010x380x285	
	Packaged weight				kg	17
	OUTDOOR	Refrigerant control			Capillary	
Compressor type, model			Rotary, HITACHI - ASH232SV-C8LU			
Fan type & quantity			Propeller(direct) x 1			
Fan speeds		H	RPM	780		
Air flow		H	m3/hr	2790		
Sound power level		H	dB(A)	64		
Sound pressure level(3)		H	dB(A)	54		
Dimensions		WxHxD	mm	913x680x378		
Net Weight				kg	46	
Package dimensions		WxHxD	mm	994x725x428		
Packaged weight				kg	50	
Refrigerant type			R410A			
Standard charge			kg(4m)	1.45		
Additional charge			g/m	30g/m(4m<L<15m)		
Connections between units		Liquid line		In.(mm)	1/4"(6.35)	
		Suction line		In.(mm)	1/2"(12.7)	
	Max.tubing length		m.	Max. 25		
	Max.height difference		m.	Max. 10		
Operation control type				Remote control		

- (1)Airflow in ducted units; at nominal external static pressure.
- (2)Sound power in ducted units is measured at air discharge.
- (3)Sound pressure level measured at 1-meter distance from unit.
- (4)Rating conditions in accordance to ISO 5151 and ISO 13253 (for ducted units).

### 3. RATING CONDITIONS

Rating conditions in accordance with ISO 5151 and ISO 13253 (for ducted units).

**Cooling:**

Indoor: 27°C DB 19°C WB

Outdoor: 35°C DB

**Heating:**

Indoor: 20°C DB

Outdoor: 7°C DB 6°C WB

#### 3.1 Operating Limits

R410A

		Indoor	Outdoor
<b>Cooling</b>	Upper limit	32°C DB 23°C WB	46°C DB
	Lower limit	21°C DB 15°C WB	21°C DB
<b>Heating</b>	Upper limit	27°C DB	24°C DB 18°C WB
	Lower limit	10°C DB	-9°C DB 80%RH
<b>Voltage</b>		1-PH 50Hz 198 – 264 V	

**4. OUTLINE DIMENSION**

**4.1 Indoor: HGF/HHF009-012-018-024**

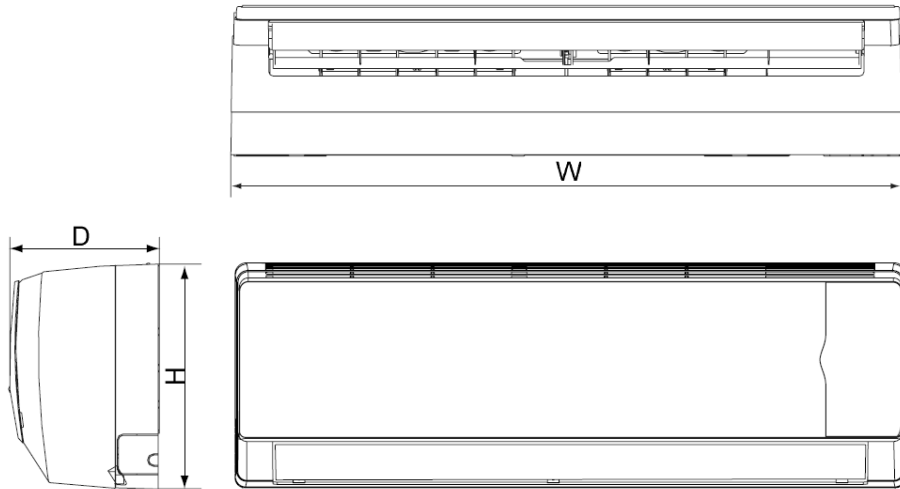

09K 12K

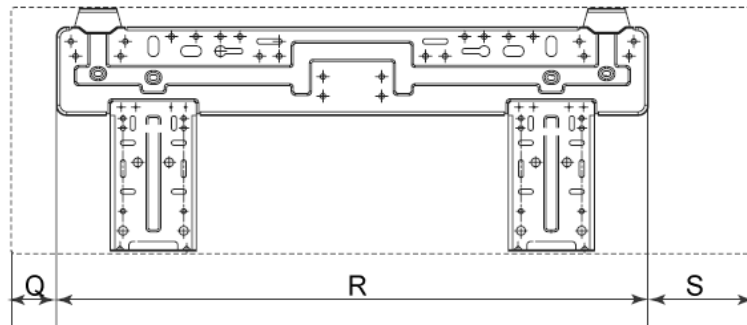

18K 22K

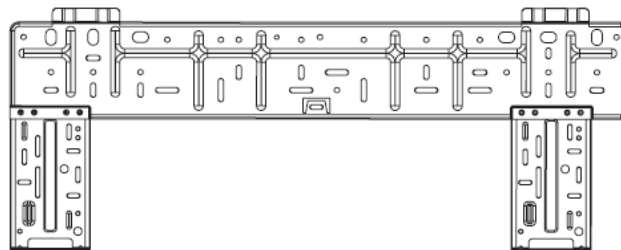

Unit: mm

Model	W	H	D	Q	R	S
09K	730	255	174	27	562	141
12K	790	265	177	35	605	150
18-24K	940	298	200	52	694	194

4.2 Outdoor: YGF009-012-018-024

Model 09/12

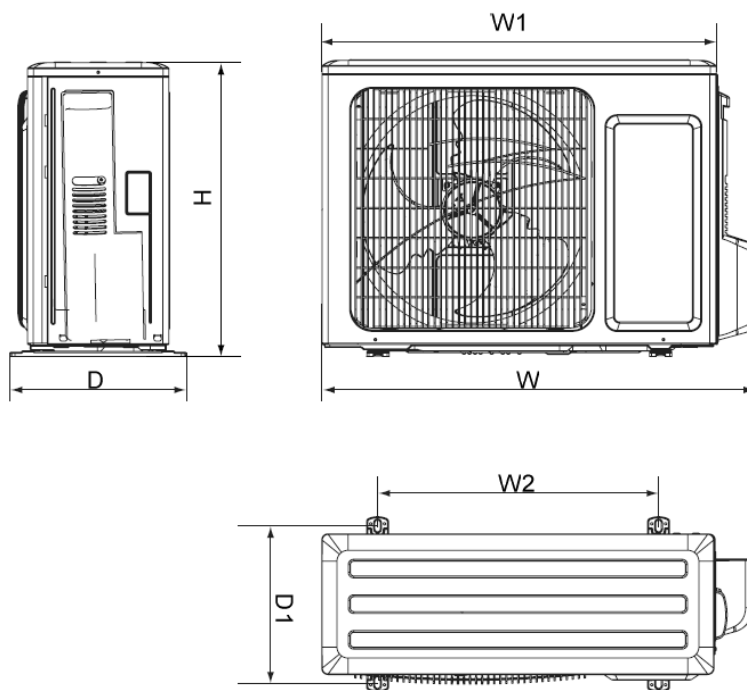

Model 18/24

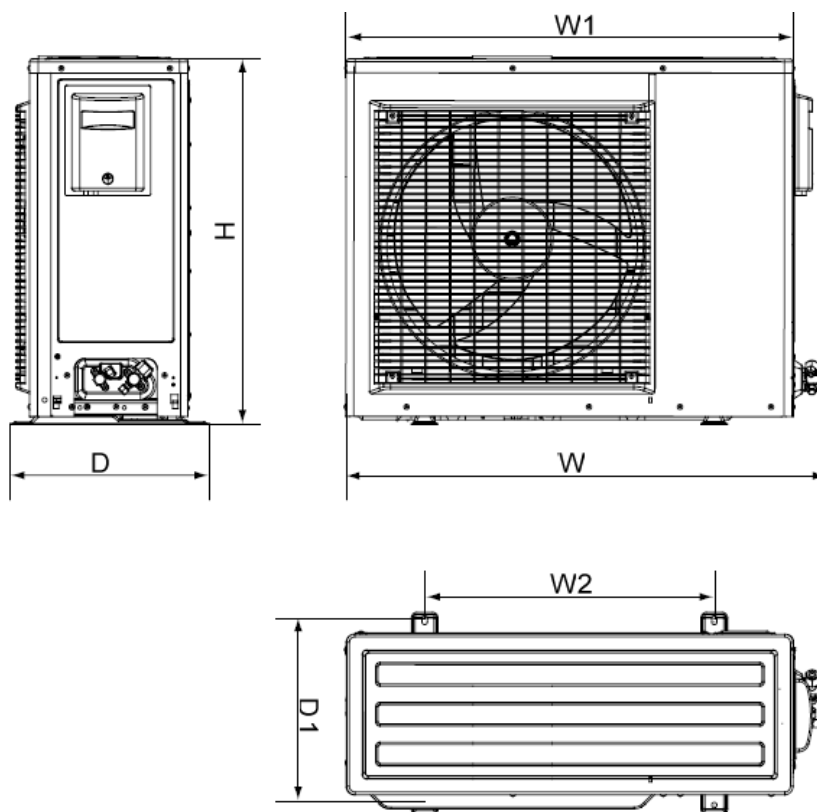

**OUTLINE DIMENSION***Airwell*

Unit: mm

Model	W	H	D	W1	W2	D1
09-12K	776	549	320	714	510	286
18-24K	913	680	378	847	549	342

**5. PERFORMANCE DATA**

**5.1 HGF009 / HHF009 // YGF009**

**5.1.1 Cooling Capacity (kW)**

Entering Air DB OD Coil(°C)	Data	Entering Air WB/DB ID Coil(°C)				
		15/21	17/24	19/27	21/29	23/32
20	TC	2.69	2.84	2.92	2.99	3.06
	SC	1.77	1.87	1.95	2.00	2.04
	PI	0.63	0.63	0.64	0.64	0.64
25	TC	2.55	2.75	2.89	2.98	3.05
	SC	1.73	1.83	1.93	1.99	2.02
	PI	0.68	0.69	0.69	0.70	0.70
30	TC	2.38	2.59	2.80	2.90	2.99
	SC	1.67	1.78	1.89	1.95	1.98
	PI	0.74	0.75	0.75	0.76	0.77
35	TC	2.20	2.39	<b>2.64</b>	2.77	2.90
	SC	1.59	1.70	<b>1.85</b>	1.90	1.94
	PI	0.79	0.81	<b>0.82</b>	0.83	0.83
40	TC	2.00	2.18	2.38	2.60	2.74
	SC	1.50	1.61	1.75	1.80	1.84
	PI	0.86	0.87	0.89	0.90	0.90
46	TC	1.74	1.90	2.09	2.31	2.49
	SC	1.38	1.48	1.59	1.65	1.69
	PI	0.94	0.95	0.97	0.99	1.00

**LEGEND**

- TC – Total Cooling Capacity, kW
- SC – Sensible Capacity, kW
- PI – Power Input, kW
- WB – Wet Bulb Temp., (°C)
- DB – Dry Bulb Temp., (°C)
- ID – Indoor
- OU – Outdoor



5.1.3 Heating Capacity (kW)

ENTERING WB OD COIL(°C)	ENTERING AIR DB ID COIL(°C)					
	15		20		25	
	TH	PI	TH	PI	TH	PI
-10	1.48	0.62	1.42	0.66	1.36	0.70
-7	1.59	0.64	1.53	0.67	1.48	0.71
-2	1.69	0.65	1.63	0.69	1.58	0.72
2	2.05	0.68	1.97	0.72	1.89	0.76
6	2.90	0.73	2.81	0.78	2.72	0.83
10	3.15	0.77	3.07	0.82	2.98	0.88
15	3.40	0.80	3.32	0.86	3.24	0.92
20	3.59	0.83	3.50	0.90	3.40	0.97

**LEGEND**

- TH - Total Heating Capacity, kW
- PI - Power Input, kW
- WB - Wet Bulb Temp., (°C)
- DB - Dry Bulb Temp., (°C)
- ID - Indoor
- OU - Outdoor

5.1.4 Curves

5.1.4.1 Cooling

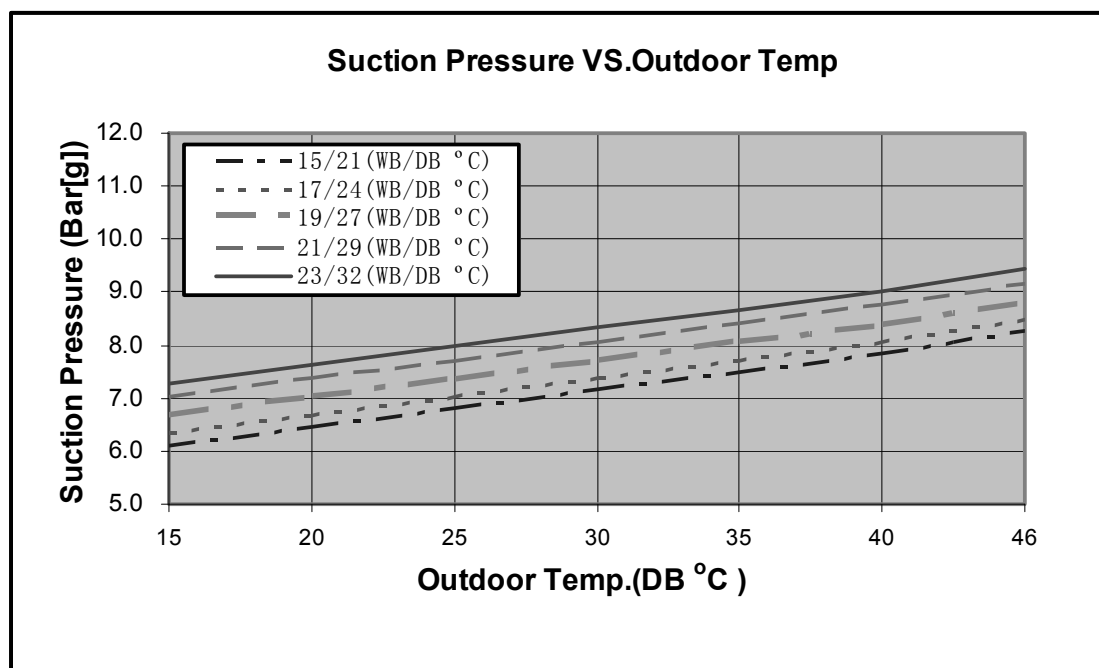

5.1.4.2 Heating

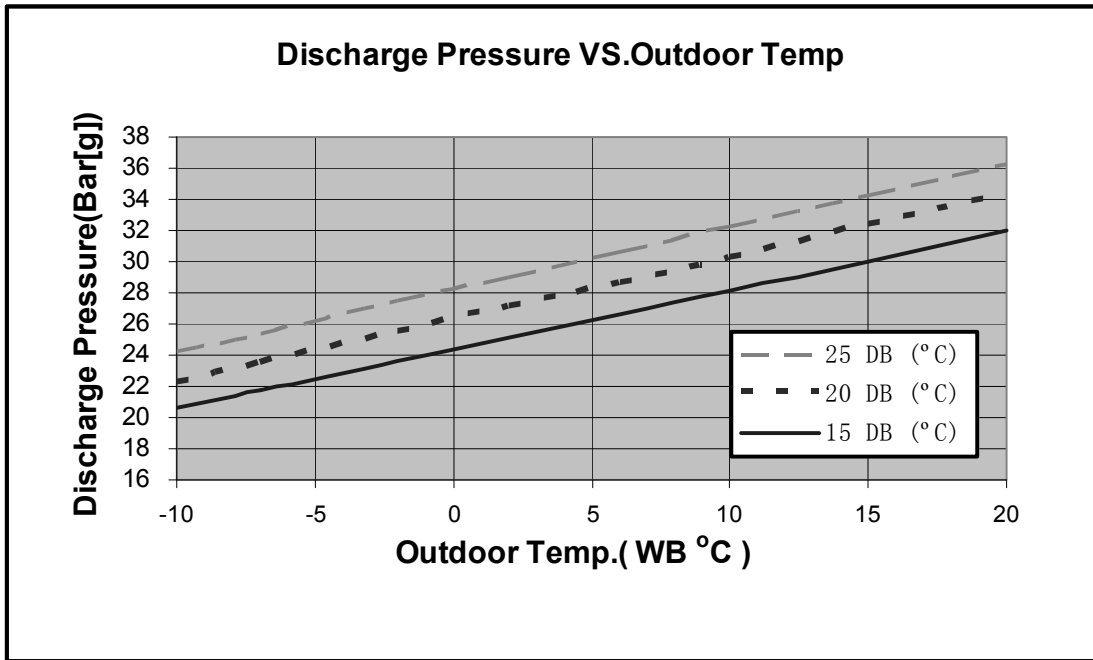

5.2 HGF012 / HHF012 // YGF012

5.2.1 Cooling Capacity (kW)

Entering Air DB OD Coil(°C)	Data	Entering Air WB/DB ID Coil(°C)				
		15/21	17/24	19/27	21/29	23/32
20	TC	3.29	3.46	3.57	3.66	3.74
	SC	2.17	2.28	2.38	2.45	2.49
	PI	0.77	0.78	0.78	0.78	0.78
25	TC	3.11	3.36	3.53	3.64	3.73
	SC	2.11	2.24	2.36	2.43	2.47
	PI	0.84	0.84	0.85	0.85	0.86
30	TC	2.91	3.17	3.42	3.54	3.65
	SC	2.04	2.17	2.31	2.38	2.42
	PI	0.90	0.91	0.92	0.93	0.94
35	TC	2.69	2.92	<b>3.22</b>	3.38	3.54
	SC	1.94	2.08	<b>2.26</b>	2.32	2.37
	PI	0.97	0.99	<b>1.00</b>	1.01	1.02
40	TC	2.45	2.67	2.91	3.18	3.34
	SC	1.83	1.97	2.13	2.20	2.25
	PI	1.05	1.06	1.08	1.10	1.11
46	TC	2.12	2.32	2.55	2.82	3.04
	SC	1.69	1.81	1.95	2.01	2.06
	PI	1.15	1.16	1.19	1.21	1.22

**LEGEND**

- TC – Total Cooling Capacity, kW
- SC – Sensible Capacity, kW
- PI – Power Input, kW
- WB – Wet Bulb Temp., (°C)
- DB – Dry Bulb Temp., (°C)
- ID – Indoor
- OU – Outdoor

**5.2.2 Heating Capacity (kW)**

ENTERING WB OD COIL(°C)	ENTERING AIR DB ID COIL(°C)					
	15		20		25	
	TH	PI	TH	PI	TH	PI
-10	1.85	0.78	1.78	0.83	1.71	0.87
-7	1.99	0.80	1.92	0.84	1.85	0.89
-2	2.11	0.81	2.04	0.86	1.97	0.90
2	2.57	0.85	2.46	0.90	2.36	0.95
6	3.62	0.91	3.52	0.97	3.39	1.03
10	3.94	0.96	3.83	1.03	3.73	1.10
15	4.25	1.00	4.15	1.08	4.04	1.15
20	4.48	1.03	4.38	1.12	4.25	1.21

**LEGEND**

- TH – Total Heating Capacity, kW
- PI – Power Input, kW
- WB – Wet Bulb Temp., (°C)
- DB – Dry Bulb Temp., (°C)
- ID – Indoor
- OU – Outdoor

5.1.5 Curves

5.1.5.1 Cooling

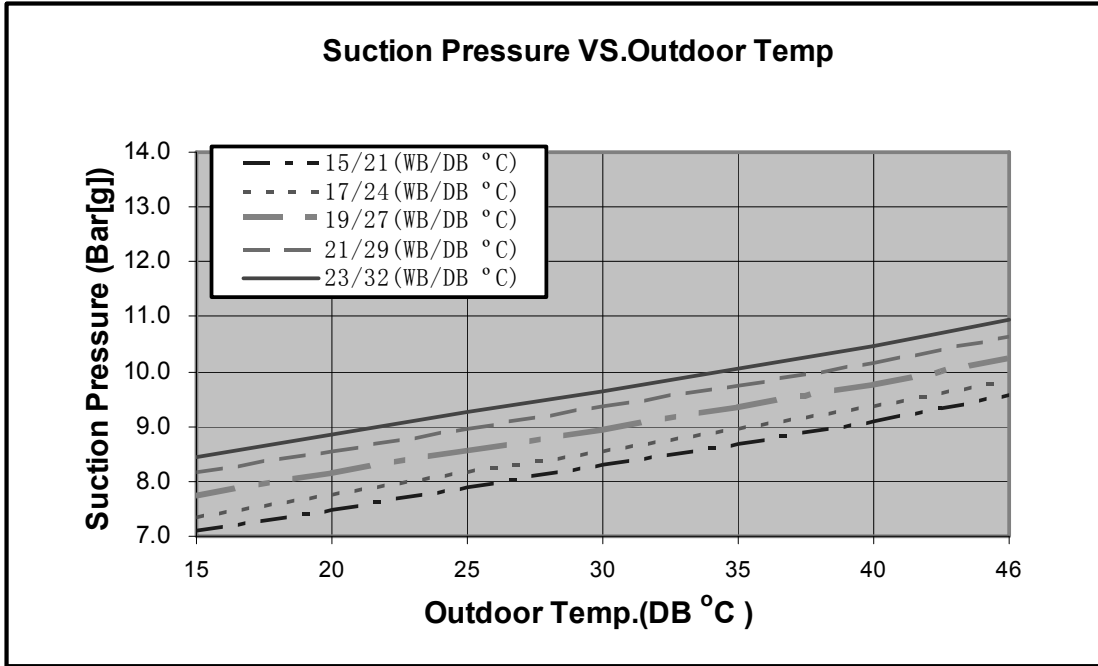

5.1.5.2 Heating

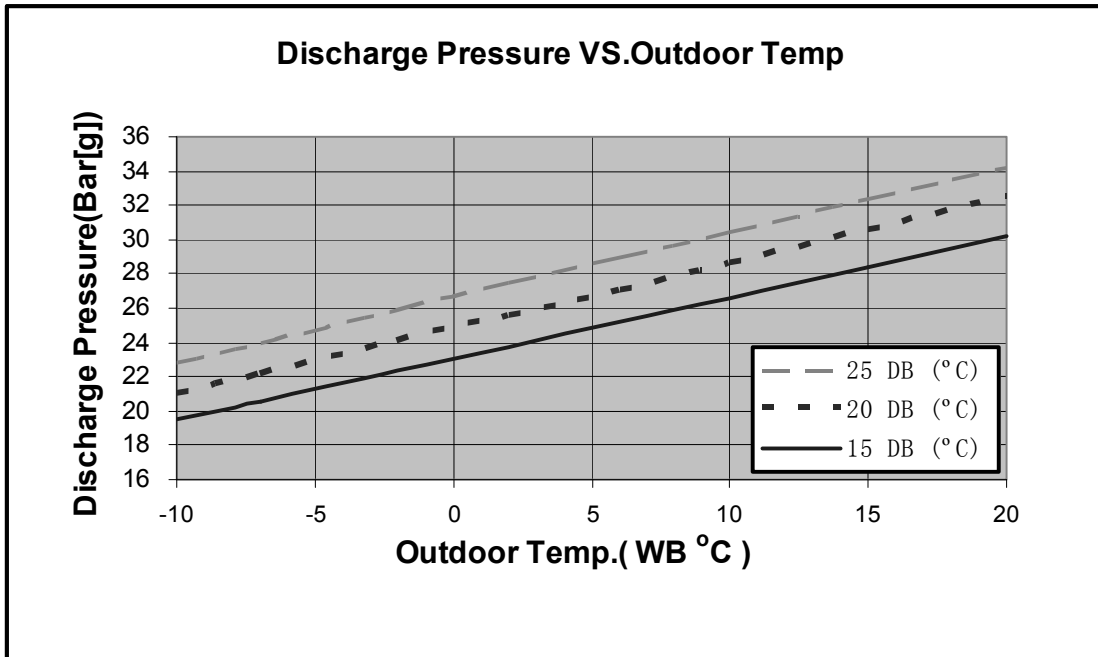

**5.3 HGF018 / HHF018 // YGF018****5.3.1 Cooling Capacity (kW)**

Entering Air DB OD Coil(°C)	Data	Entering Air WB/DB ID Coil(°C)				
		15/21	17/24	19/27	21/29	23/32
20	TC	5.40	5.70	5.88	6.02	6.14
	SC	3.56	3.75	3.91	4.02	4.10
	PI	1.26	1.27	1.27	1.28	1.28
25	TC	5.11	5.52	5.81	5.98	6.13
	SC	3.47	3.68	3.88	3.99	4.07
	PI	1.36	1.37	1.38	1.39	1.40
30	TC	4.78	5.21	5.63	5.83	6.00
	SC	3.36	3.57	3.80	3.91	3.98
	PI	1.47	1.49	1.51	1.52	1.53
35	TC	4.43	4.80	<b>5.30</b>	5.57	5.83
	SC	3.20	3.43	<b>3.71</b>	3.82	3.89
	PI	1.59	1.61	<b>1.64</b>	1.65	1.66
40	TC	4.03	4.38	4.78	5.23	5.50
	SC	3.01	3.24	3.51	3.62	3.70
	PI	1.71	1.74	1.77	1.79	1.81
46	TC	3.49	3.82	4.20	4.64	5.00
	SC	2.77	2.97	3.20	3.31	3.39
	PI	1.87	1.90	1.94	1.97	1.99

**LEGEND**

- TC – Total Cooling Capacity, kW  
 SC – Sensible Capacity, kW  
 PI – Power Input, kW  
 WB – Wet Bulb Temp., (°C)  
 DB – Dry Bulb Temp., (°C)  
 ID – Indoor  
 OU – Outdoor

5.1.3 Heating Capacity (kW)

ENTERING WB OD COIL(°C)	ENTERING AIR DB ID COIL(°C)					
	15		20		25	
	TH	PI	TH	PI	TH	PI
-10	2.99	1.34	2.88	1.42	2.76	1.49
-7	3.22	1.37	3.11	1.44	2.99	1.52
-2	3.42	1.39	3.31	1.47	3.19	1.55
2	4.16	1.45	3.99	1.54	3.82	1.64
6	5.87	1.56	5.70	1.67	5.50	1.77
10	6.38	1.65	6.21	1.76	6.04	1.88
15	6.90	1.72	6.73	1.85	6.56	1.97
20	7.27	1.77	7.10	1.92	6.90	2.07

**LEGEND**

- TH – Total Heating Capacity, kW
- PI – Power Input, kW
- WB – Wet Bulb Temp., (°C)
- DB – Dry Bulb Temp., (°C)
- ID – Indoor
- OU – Outdoor

5.1.6 Curves

5.1.6.1 Cooling

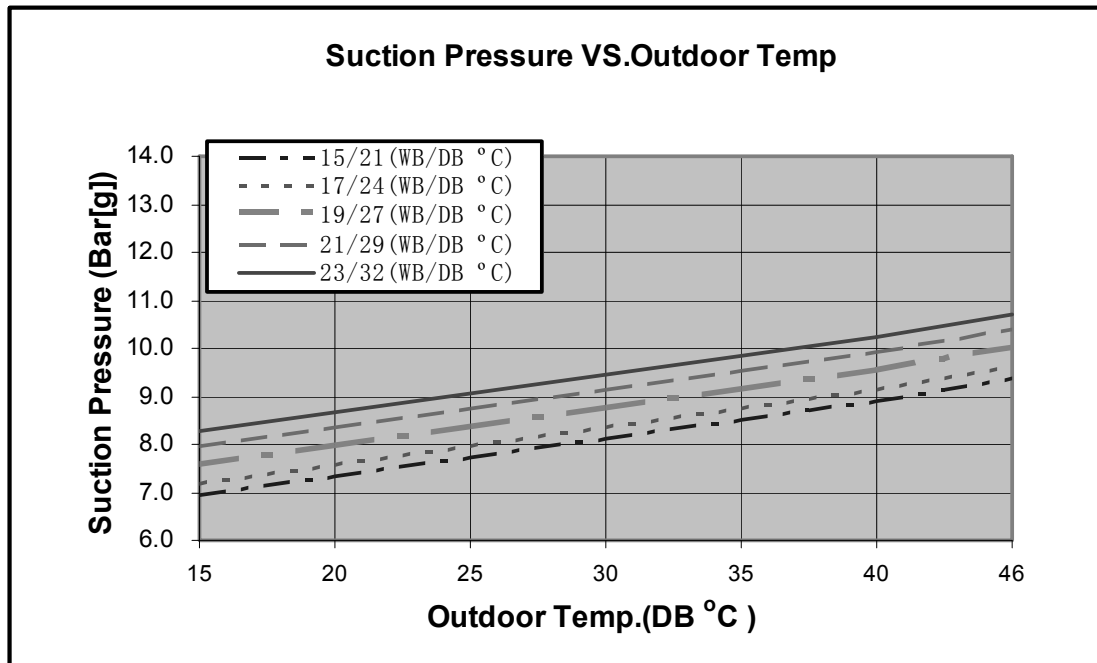

5.1.6.2 Heating

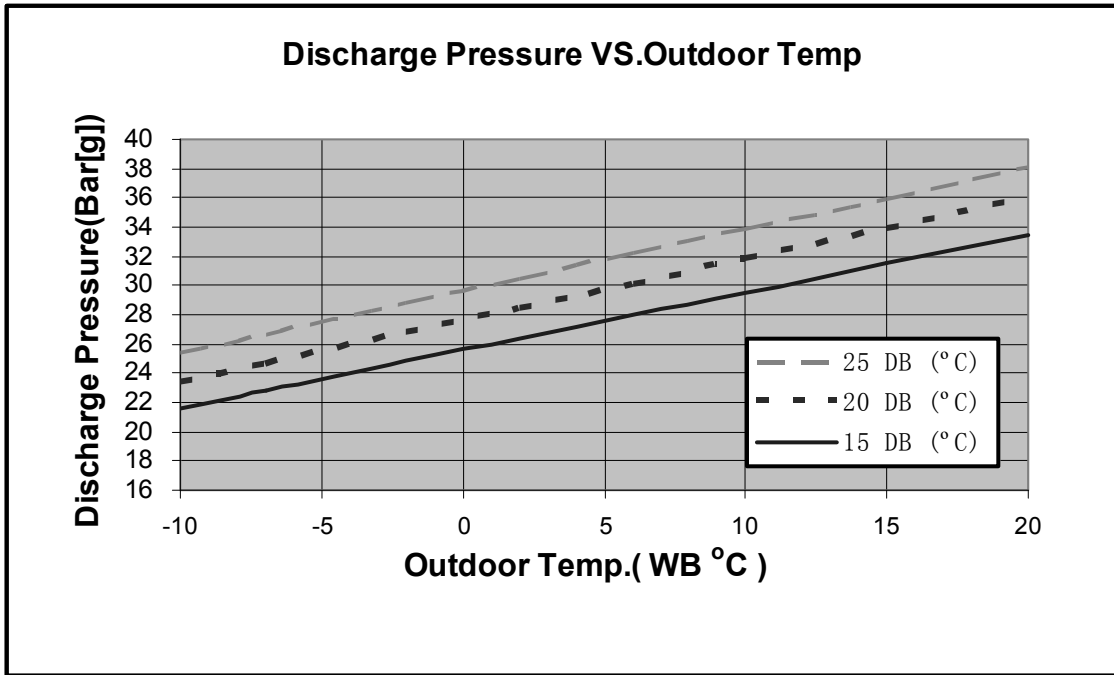

5.4 HGF024 / HHF024 // YGF024

5.4.1 Cooling Capacity (kW)

Entering Air DB OD Coil(°C)	Data	Entering Air WB/DB ID Coil(°C)				
		15/21	17/24	19/27	21/29	23/32
20	TC	6.28	6.62	6.82	6.99	7.14
	SC	4.14	4.36	4.54	4.67	4.76
	PI	1.46	1.47	1.47	1.48	1.48
25	TC	5.94	6.41	6.74	6.95	7.11
	SC	4.03	4.28	4.51	4.64	4.72
	PI	1.58	1.59	1.60	1.61	1.62
30	TC	5.55	6.05	6.53	6.77	6.97
	SC	3.90	4.15	4.41	4.54	4.63
	PI	1.70	1.73	1.74	1.76	1.77
35	TC	5.14	5.58	<b>6.16</b>	6.46	6.77
	SC	3.71	3.98	<b>4.31</b>	4.43	4.52
	PI	1.84	1.87	<b>1.90</b>	1.91	1.93
40	TC	4.68	5.09	5.55	6.07	6.39
	SC	3.50	3.76	4.08	4.21	4.29
	PI	1.98	2.01	2.05	2.07	2.09
46	TC	4.06	4.44	4.88	5.39	5.81
	SC	3.22	3.45	3.72	3.85	3.93
	PI	2.17	2.20	2.25	2.28	2.31

**LEGEND**

- TC – Total Cooling Capacity, kW
- SC – Sensible Capacity, kW
- PI – Power Input, kW
- WB – Wet Bulb Temp., (°C)
- DB – Dry Bulb Temp., (°C)
- ID – Indoor
- OU – Outdoor

**5.4.2 Heating Capacity (kW)**

ENTERING WB OD COIL(°C)	ENTERING AIR DB ID COIL(°C)					
	15		20		25	
	TH	PI	TH	PI	TH	PI
-10	3.41	1.52	3.28	1.62	3.15	1.70
-7	3.67	1.56	3.54	1.64	3.41	1.73
-2	3.90	1.58	3.77	1.67	3.64	1.77
2	4.75	1.65	4.55	1.76	4.36	1.86
6	6.70	1.78	6.50	1.90	6.27	2.02
10	7.28	1.88	7.09	2.00	6.89	2.14
15	7.87	1.96	7.67	2.11	7.48	2.24
20	8.29	2.01	8.09	2.19	7.87	2.36

**LEGEND**

- TH – Total Heating Capacity, kW
- PI – Power Input, kW
- WB – Wet Bulb Temp., (°C)
- DB – Dry Bulb Temp., (°C)
- ID – Indoor
- OU – Outdoor



5.1.7 Curves

5.1.7.1 Cooling

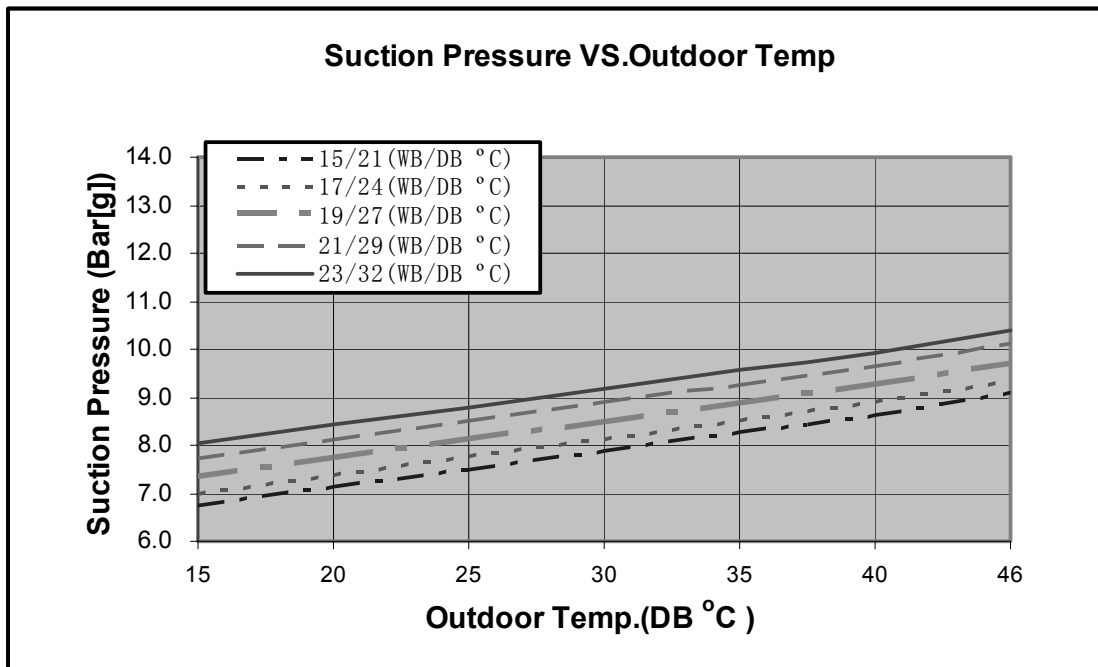

5.1.7.2 Heating

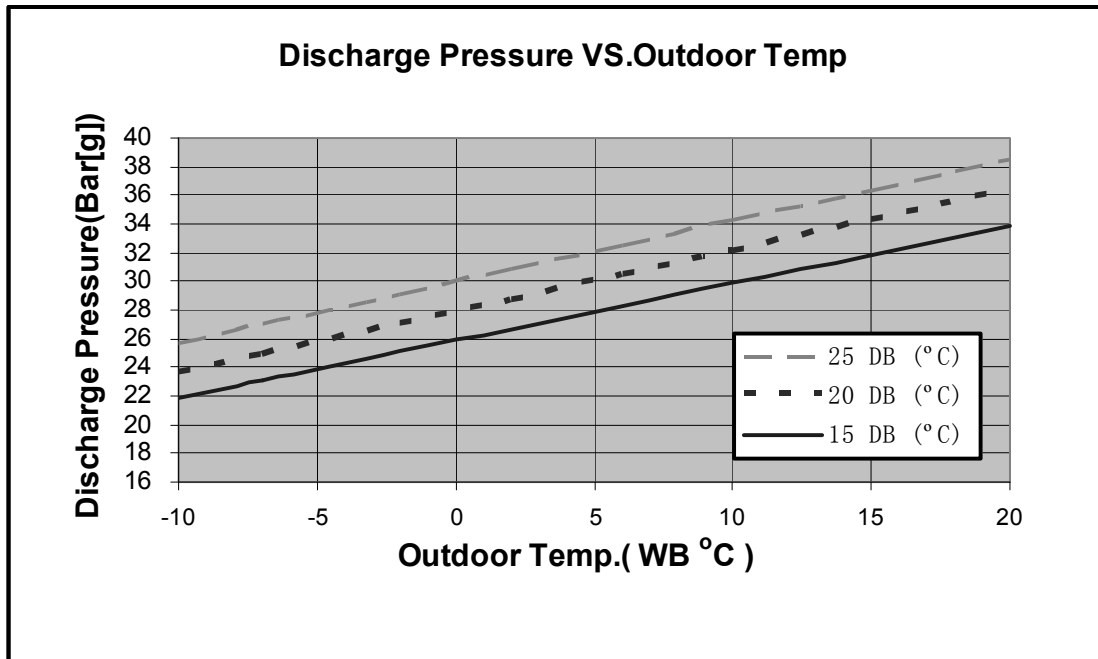

## 6. SOUND LEVEL CHARACTERISTICS

### 6.1 Sound Pressure Level - Indoor

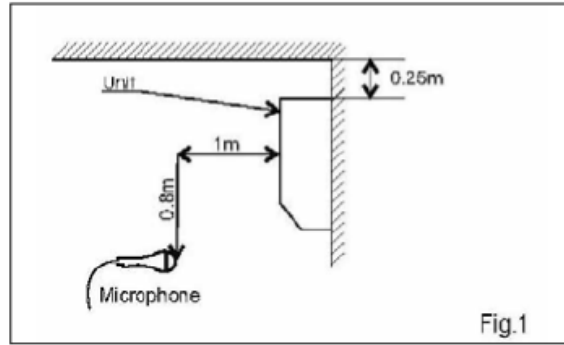
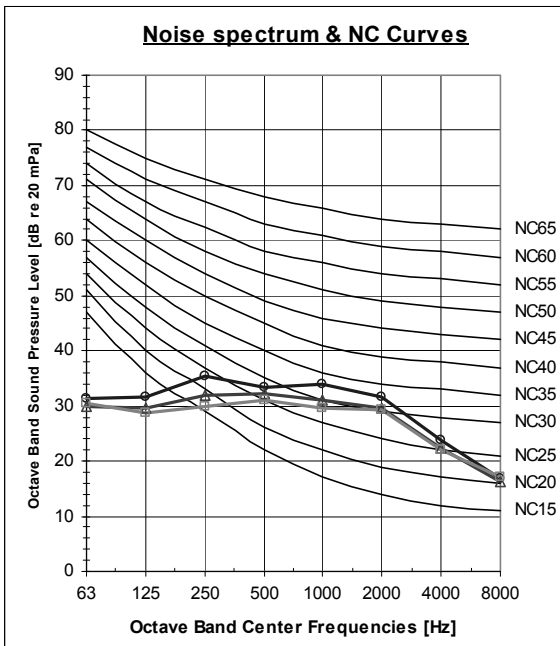

Figure 1. Wall Mounted

### 6.2 Sound Pressure Level Spectrum - Indoor (Measured as Figure 1)

HGF007 / HHF007 / HGF009 / HHF009  
Cooling



HGF007 / HHF007 / HGF009 / HHF009  
Heating

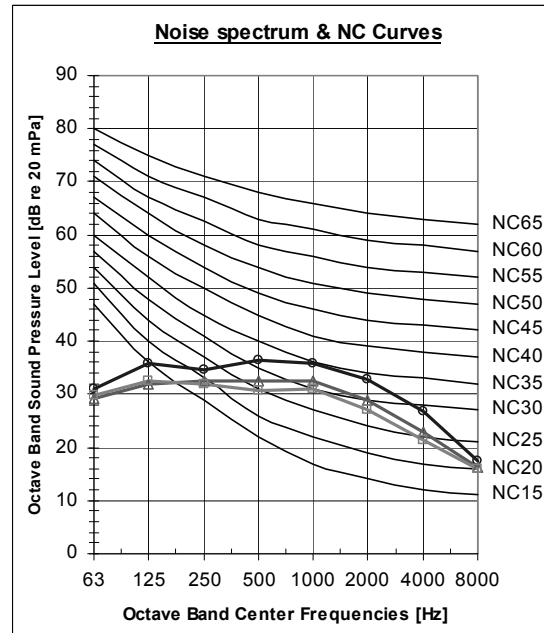

**HGF012 / HHF012  
Cooling**

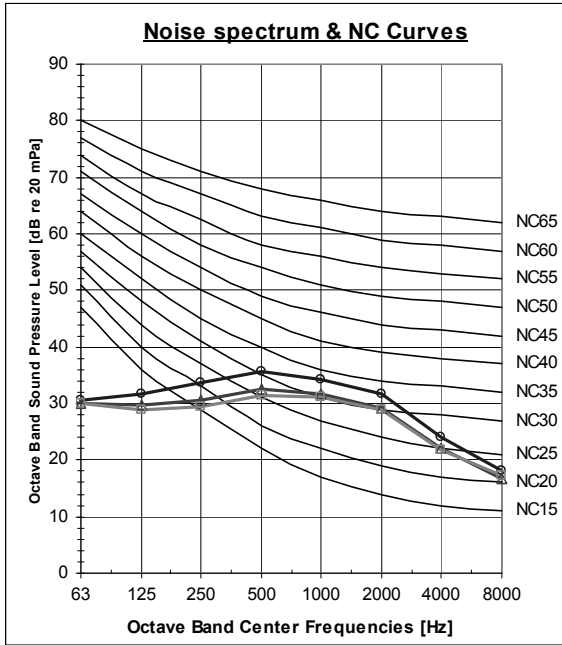

**HGF012 / HHF012  
Heating**

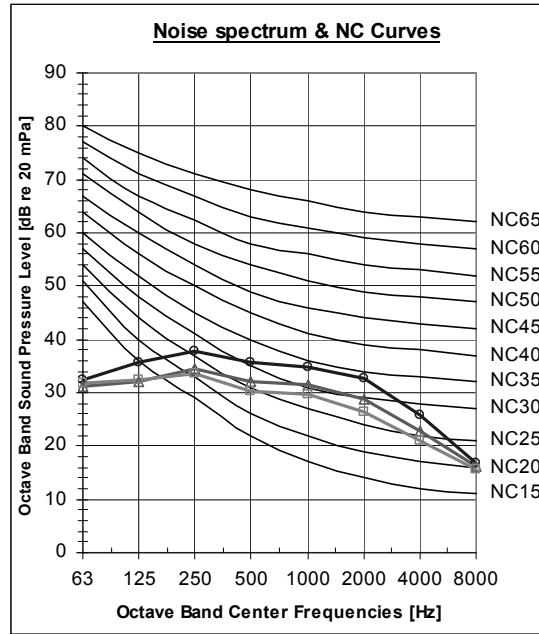

**HGF018 / HHF018  
Cooling**

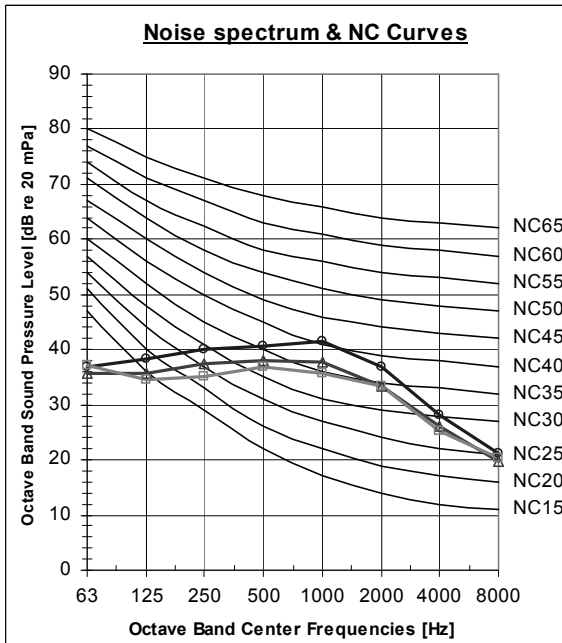

**HGF018 / HHF018  
Heating**

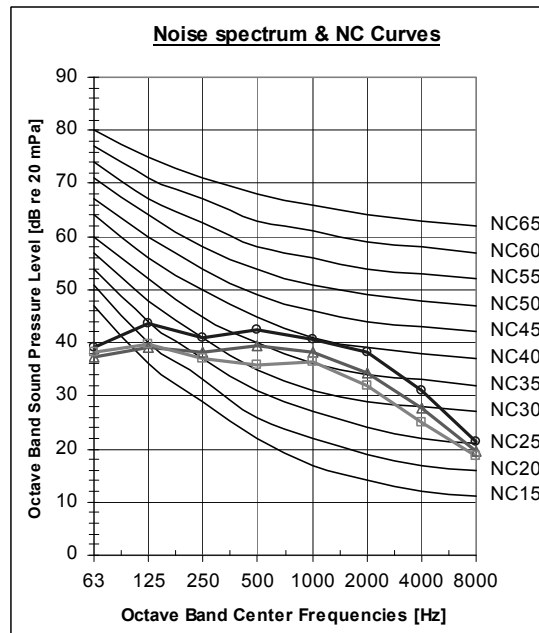

HGF024 / HHF024  
Cooling

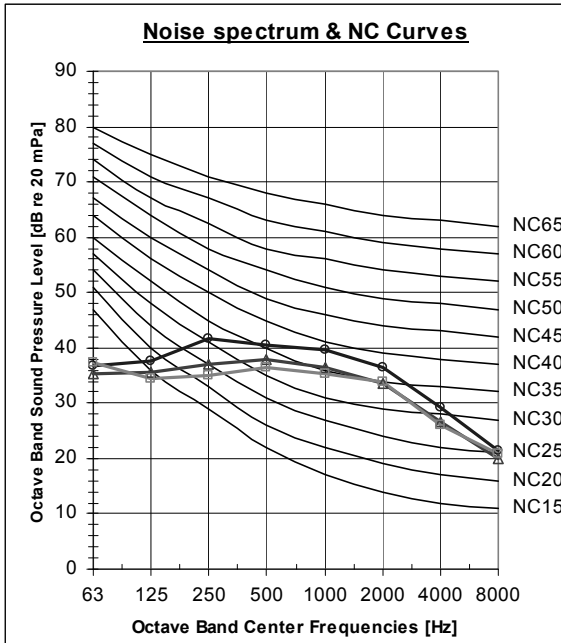

HGF024 / HHF024  
Heating

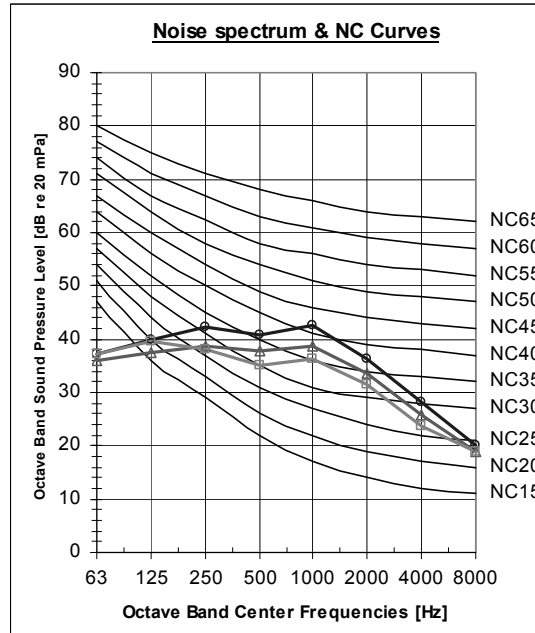

6.3 Sound Pressure Level - Outdoor

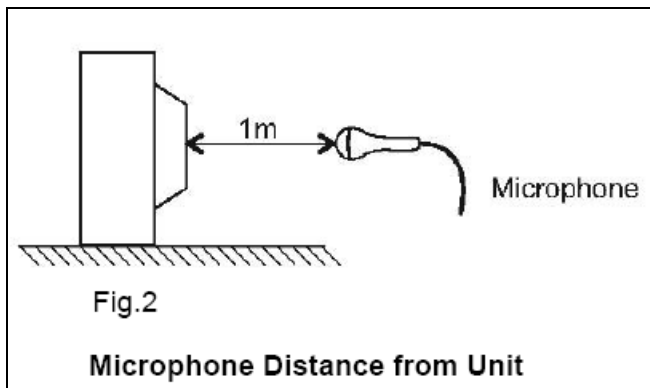

6.4 Sound Pressure Level Spectrum - Outdoor (Measured as Figure 1)

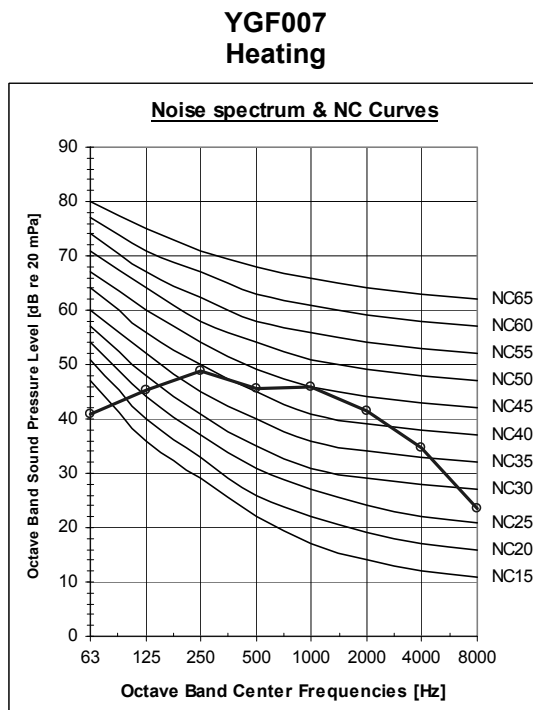
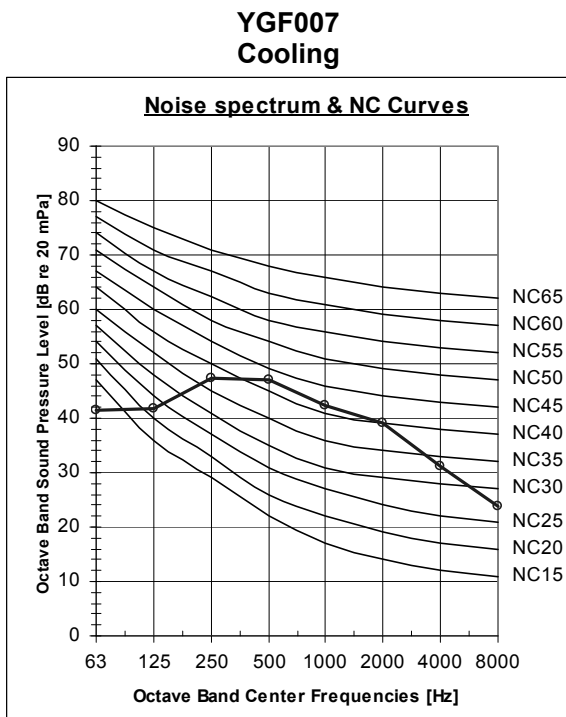

**YGF009  
Cooling**

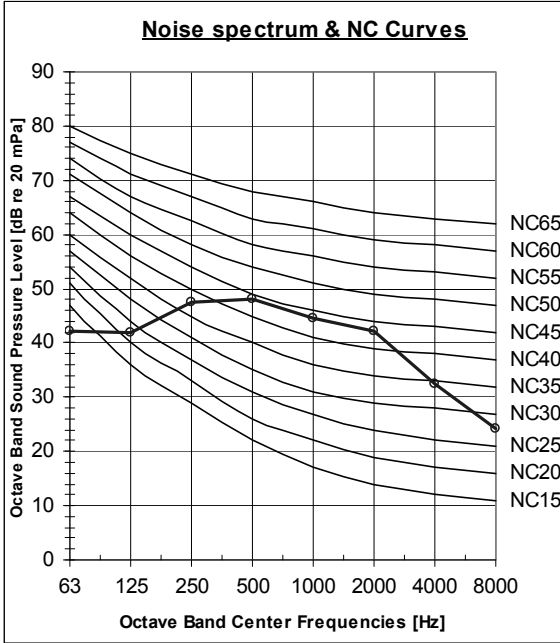

**YGF009  
Heating**

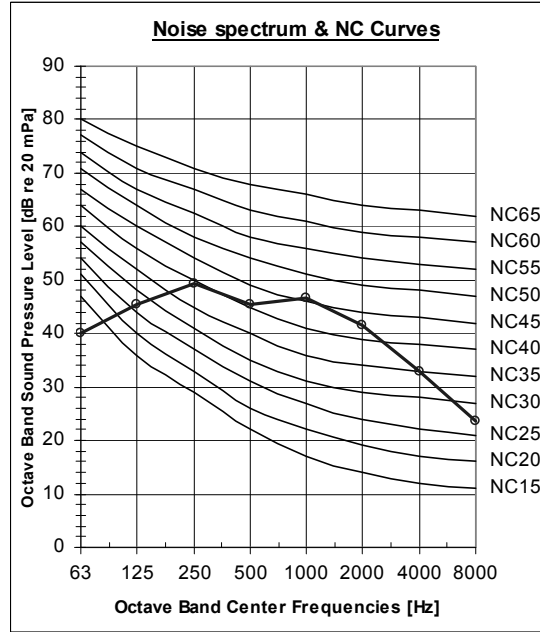

**YGF012  
Cooling**

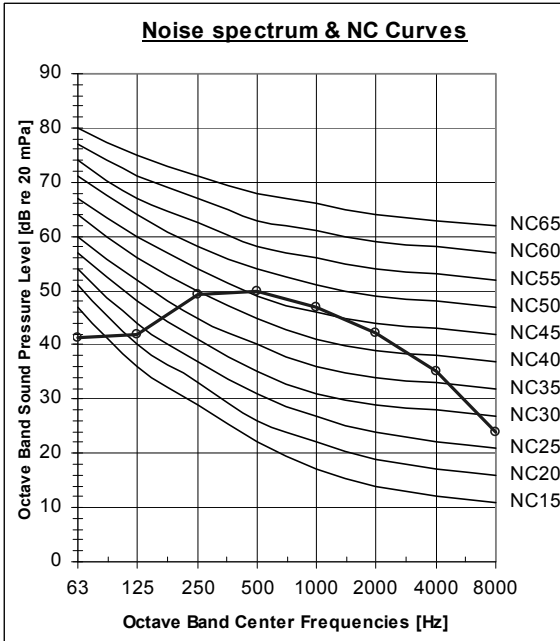

**YGF012  
Heating**

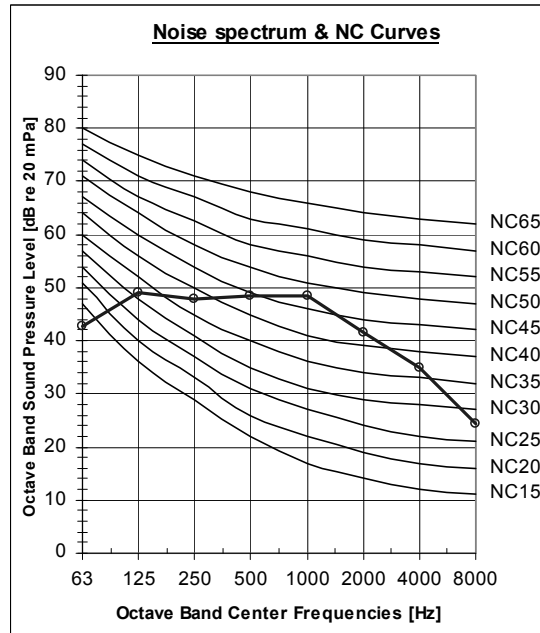

**YGF018  
Cooling**

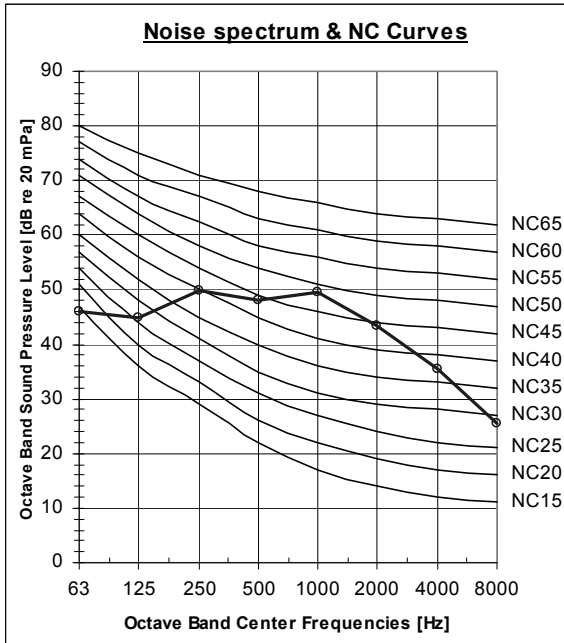

**YGF018  
Heating**

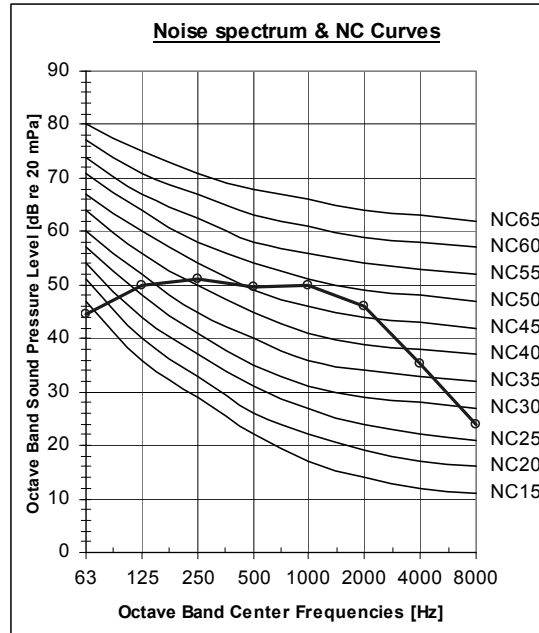

**YGF024  
Cooling**

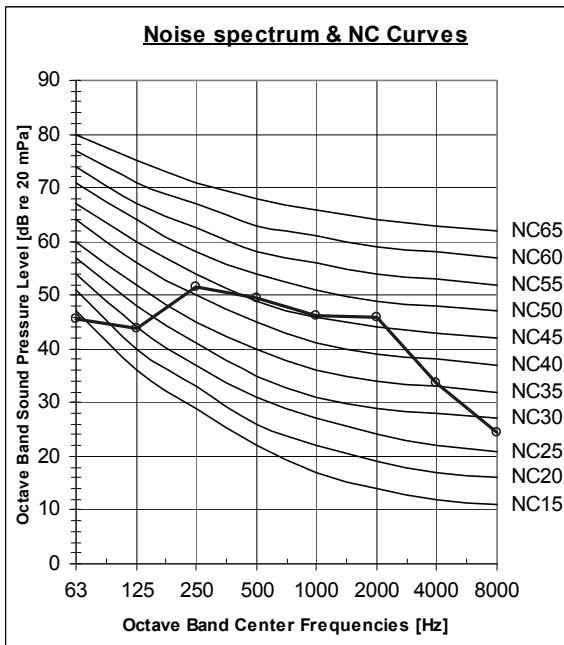

**YGF024  
Heating**

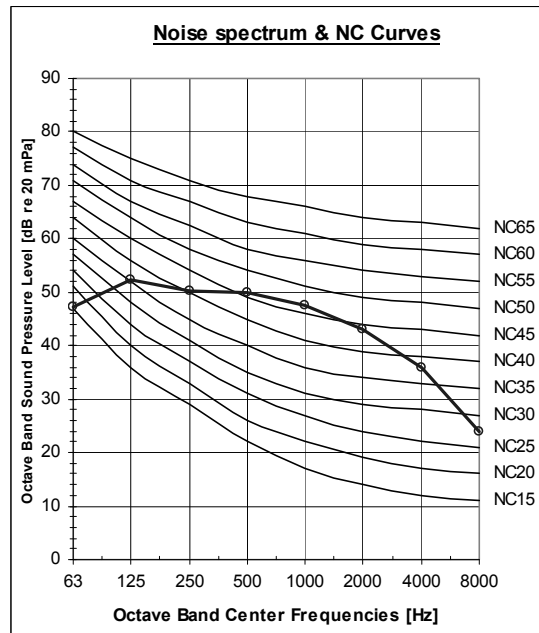

## 7. ELECTRICAL DATA

MODEL	YGF009	YGF012	YGF018	YGF024
Power Supply	To indoor			
	1PH-220-240V-50Hz			
Max Current, A	5.1A	6.3A	11.1A	11.7
Circuit Breaker, A	10A	16A	25A	25A
Power Supply No. X Cross Section mm <sup>2</sup>	3x1.0		3x2.5	
Interconnecting Cable No. X Cross Section mm <sup>2</sup>	3X1.0+2X0.75		5x2.5	

### NOTE

Power wiring cord should comply with local laws and electrical regulations requirements.



## 8. WIRING DIAGRAM

### 8.1 HGF009 / HHF009 // YGF009

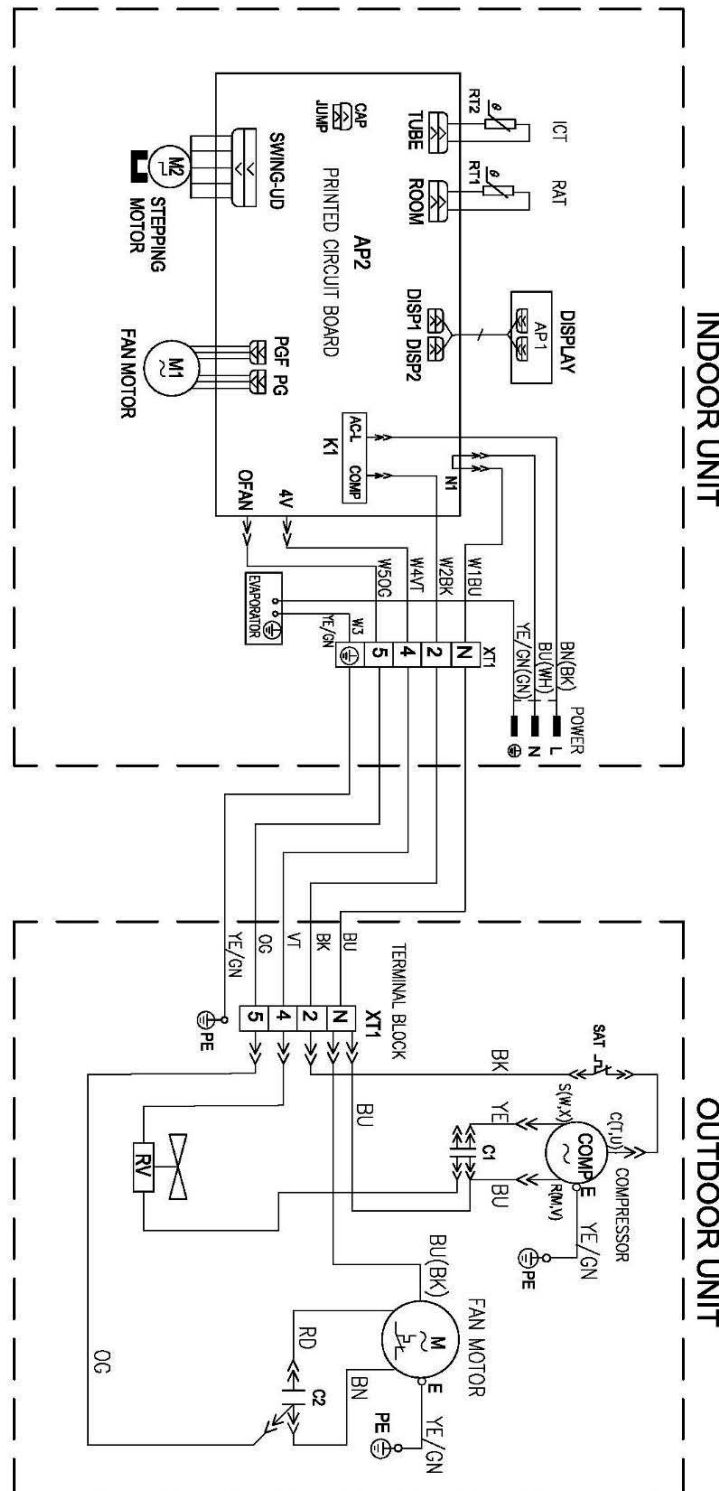

8.2 HGF012 / HGF012 // YGF012

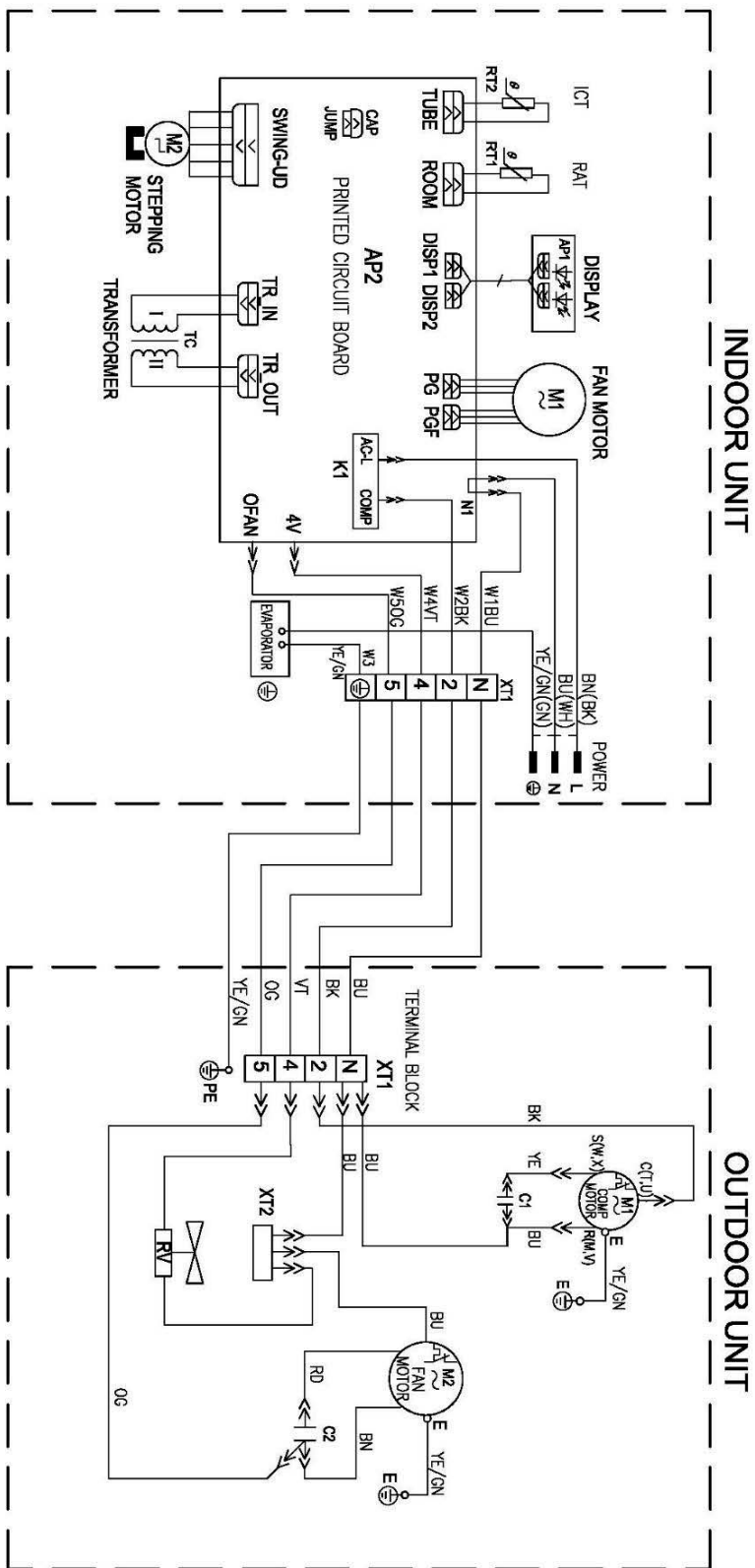

8.3 HGF018 / HHF018 // YGF018

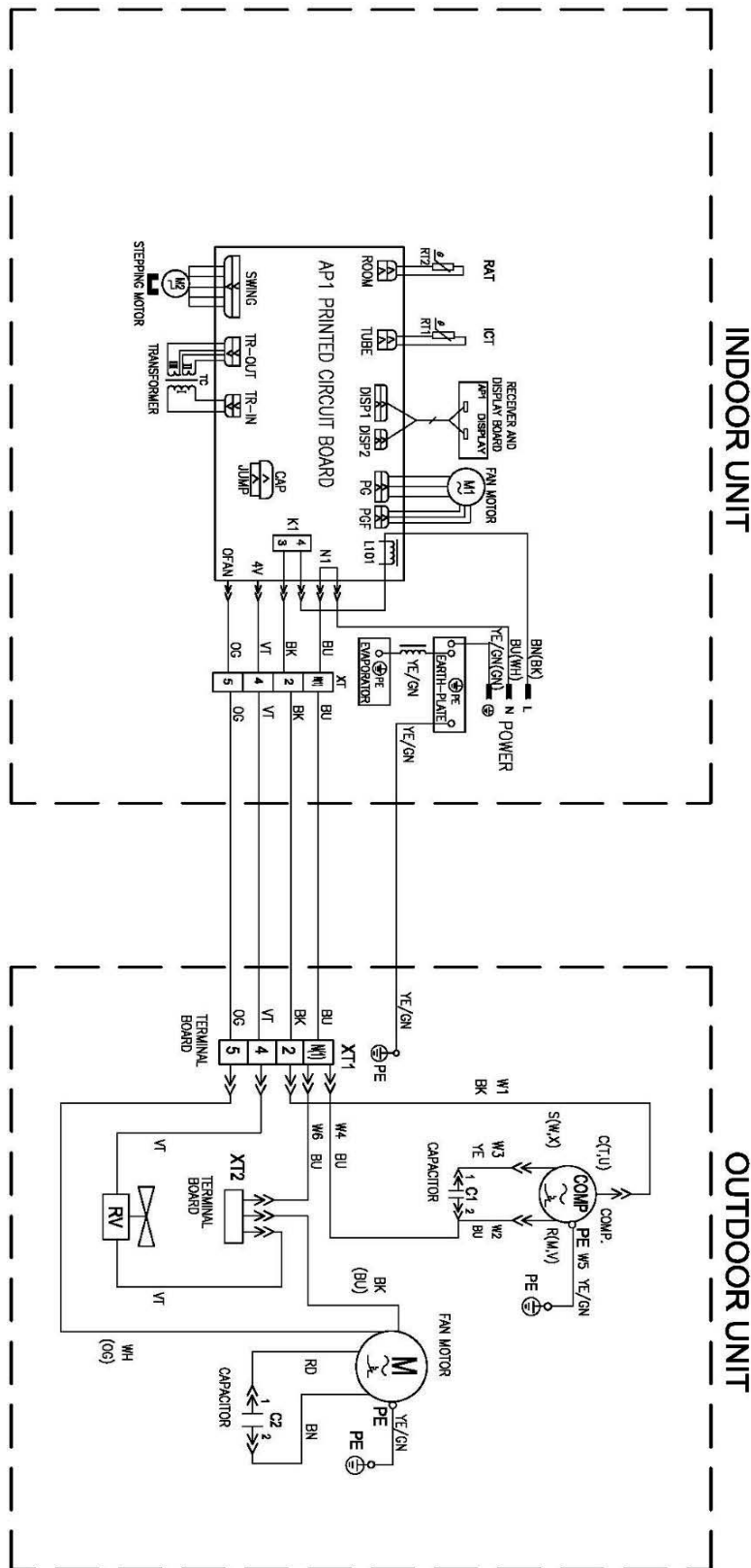



9. REFRIGERATION DIAGRAMS

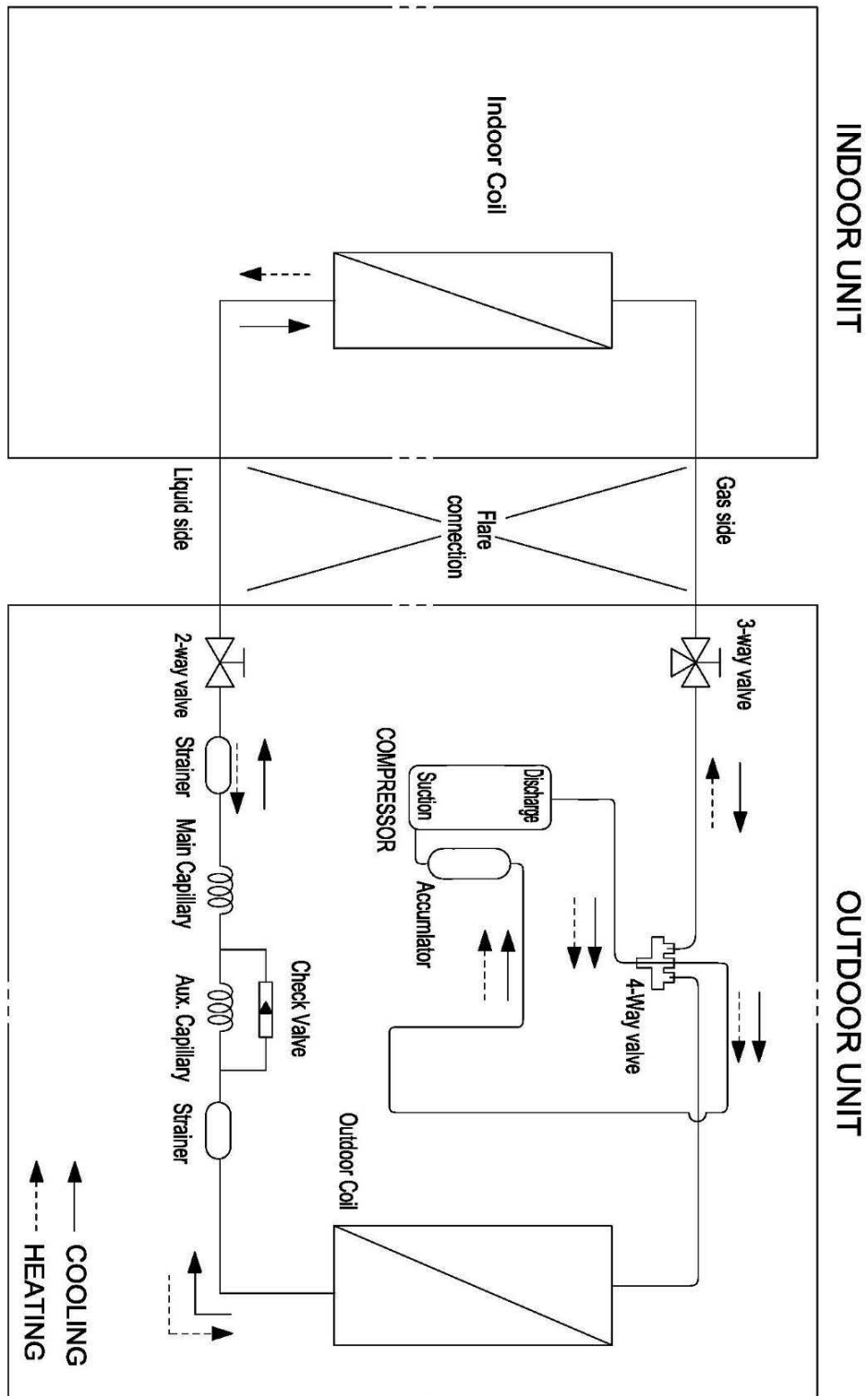

## 10. TUBING CONNECTIONS

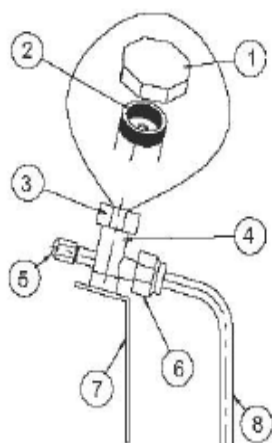
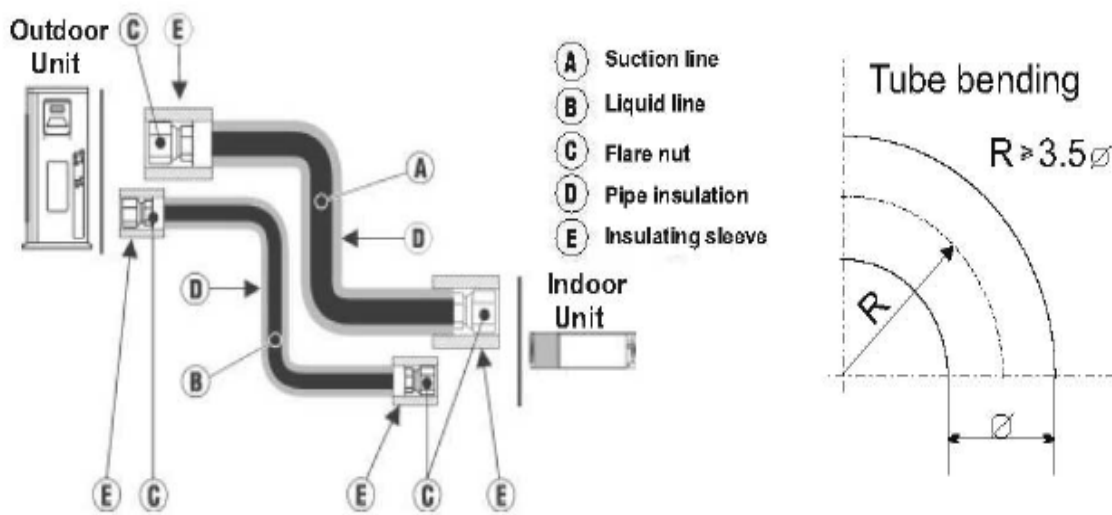

TUBE (Inch)	1/4"	3/8"	1/2"	5/8"	3/4"
<b>TORQUE (Nm)</b>					
<b>Flare Nuts</b>	15-18	40-45	60-65	70-75	80-85
<b>Valve Cap</b>	13-20	13-20	18-25	18-25	40-50
<b>Service Port Cap</b>	11-13	11-13	11-13	11-13	11-13

1. Valve Protection Cap-end
2. Refrigerant Valve Port (use Allen wrench to open/close)
3. Valve Protection Cap
4. Refrigerant Valve
5. Service Port Cap
6. Flare Nut
7. Unit Back Side
8. Copper Tube

When the outdoor unit is installed above the indoor unit an oil trap is required every 5m along the suction line at the lowest point of the riser. In case the indoor unit is installed above the outdoor, no trap is required.

## 11. CONTROL SYSTEM

### 11.1 Electronic Control

#### 11.1.1 Abbreviations

AC	-Alternate Current
A/C	- Air-Conditioner
ANY	- ON or OFF status
COMP	- Compressor
CPU	- Central Processing Unit
E2PROM, EEP	- Erase Enable Programmable Read Only Memory
H/W	- Hardware
ICT	- Indoor Coil Temperature sensor
IF, IFAN	- Indoor Fan
IR	- Infra Red
Max	- Maximum
Min	- Minimum
min	- Minute (time)
NA	- Not Applicable
OCT	- Outdoor Coil Temperature sensor
OF, OFAN	- Outdoor Fan OPER - Operate Para. - Paragraph
RAT	- Return Air Temperature (RT1) sensor
RC	- Reverse Cycle (Heat Pump)
R/C	- Remote Control
RCT	- Remote Control Temperature
RH	- Resistance Heater
RV	- Reversing Valve
SB, STBY	- Stand-By
Sec	- Second (time)
Sect	- Section
SH	- Supplementary Heater
SPT	- Set Point Temperature
ST	- Standard (a Model with Cooling Only)
S/W	- Software
TEMP	- Temperature
W/O	- Without

## 11.1.2 System Operation Concept

### 11.1.3 Compressor operation

For each Mode including POWER OFF & SB, a Min time delay of 3 min before COMP restarting except during outdoor deicing.

Whenever COMP starts, it will not stop in 6 min even the RAT is changed.

\* For the units with memory function, the 1<sup>st</sup> time of Power ON, there will be no 3 min delay if the previous stage of unit is OFF.

### 11.1.4 Indoor Fan Control

8 Indoor fan speeds are determined for each model. 4 speeds for COOL modes and 4 speeds for HEAT mode.

Unit Model	Mode	Turbo(Super high)	High	Medium	Low
09	Cooling	1390	1280	1180	1080
	Heating	1350	1250	1140	1040
12	Cooling	1350	1250	1100	950
	Heating	1350	1250	1100	950
18	Cooling	1350	1200	1050	900
	Heating	1350	1200	1050	900
24	Cooling	1350	1200	1050	900
	Heating	1420	1250	1150	900

In high/ medium/ low indoor fan user setting, unit will operate fan in selected speed.

In AutoFan user setting, fan speed will be adjusted automatically according to the difference between actual room temperature(RAT) and user set point temperature(SPT).

Indoor Fan speed		High	Medium	Low
RAT-SPT	Cooling	$\geq 2$	(0,2)	$\leq 0$
	Heating	$\leq 1$	(1,3)	$\geq 3$

During Auto Fan operating, one speed should keep at least 210sec operating before switching to other speeds.

In DRY mode, the automatic fan speed is forced to be low.

#### 11.1.4.1 Turbo Speed

In COOL and HEAT mode (not available in AUTO, DRY, FAN mode), press the Turbo button, the super high fan speed is selected on Remote control and the indoor fan rotates at super high speed.

### 11.1.5 Outdoor Fan Control



### 11.1.5.1 OFAN Speed Type

The OFAN motor is a one speed AC motor and controlled by the relay on outdoor controller.

### 11.1.5.2 General rules

1. The OFAN is ON when COMP ON during Cool, Dry and Heat Mode.
2. When the unit is off by remote control, in safety stops and stop after reaching to the temperature point, the outdoor fan stops.
3. Outdoor fan OFF will compressor when COMP is OFF during cooling and heating mode.

### 11.1.6 Refrigerant control

Capillary is used in each mode.

### 11.1.7 Reversing Valve (RV) Control

Reversing valve is on in heat mode.

Switching of RV state is done only after COMP is off for over 2 minutes.

## 11.2 Fan Mode

In this mode, the IFAN may run at high, medium, low and automatic speed. The COMP, OFAN and RV will be OFF.

In this mode, the range of setting temperature is 16~30C

## 11.3 Cool Mode

If  $RAT \geq SPT + 1$ , the unit starts cooling operation. In this case, the COMP and OFAN will operate and the IFAN will run at the setting speed.

If  $RAT \leq SPT - 1$ , the COMP and OFAN will stop operating, while the IFAN will run at the setting speed.

If  $SPT - 1 < RAT \leq SPT + 1$ , the unit will maintain the previous status.

In AutoFan user setting, fan speed will be adjusted automatically according to the SPT and RAT, refer to 11.1.4

## 11.4 Heat Mode

If  $RAT \leq SPT + 2$ , the unit will operate in heating mode. The COMP, OFAN and RV will operate and the IFAN will delay 3min to start at the latest

If  $SPT + 2 \leq RAT \leq SPT + 4$ , the unit will maintain the previous status.

If  $RAT \geq SPT + 4$ , the COMP and OFAN will stop and the IFAN will blow for 60s at setting speed.

During this period, the fan speed cannot be switched.

### 11.4.1 Indoor Fan Control in Heat Mode

IFAN speed depends on the indoor coil temperature

### Anti-cold air function

When starting the heating mode, anti-cold air function will be activated and IFAN can run at low speed or stop running. This function will terminate after the unit runs for 2min or the ICT reaches 40 degree.

### Residual heat blowing function

During heating, when the stopping condition for the COMP is reached, the COMP and OFAN stop running while the louver moves to position L. The IFAN will stop after running for 60s at setting speed.

## 11.5 Auto Cool/Heat Mode

In AUTO mode, the system selects the running mode (COOL/HEAT/FAN) automatically according to the room temperature. The display shows the actual running mode and setting temperature. There will be 30s delay for mode conversion.

1. When  $RAT \geq 25$  degree, the cooling mode is selected.
2. When  $RAT \leq 20$  degree, the unit runs in heating mode
3. When  $20 \text{ degree} < RAT < 25 \text{ degree}$ , upon initial startup, the unit will enter auto mode and run in automatic fan mode. If the other mode changes into auto mode, the previous running mode will remain.

## 11.6 Dry Mode

If  $RAT \geq SPT + 2$ , the unit starts cooling operation. In this case, the COMP and OFAN will operate and the IFAN will run at the low speed.

If  $RAT \leq SPT - 2$ , the COMP and OFAN will stop. While IFAN will run at low speed.

If  $SPT - 2 < RAT \leq SPT + 2$ , While IFAN will run at low speed. COMP and OFAN will operation in 6 min ON and 4 min OFF in cycling.

In this mode, the RV will be OFF and the temperature setting range is 16~30.

## 11.7 Louver Control

After power on, the up and down swing louver will automatically open and then close completely.

In heating mode, if the swing function is not set, the up and down louver will rotate to maximum in clockwise direction. Then it will rotate to position D. Under other states, the upper and lower air deflector will rotate to level L.

If the swing function is set when starting the unit, the louver will swing between Position L and D. there are 7 states for louver: in position L, A, B, C, D, and swing between L and D, stop in any place between Position L and position D. When the unit is turned

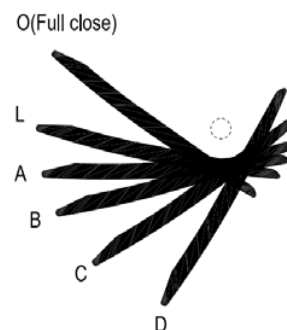

off, the air deflector will stay in position 0.

The swing is available only when the swing function is set and the indoor fan is running.  
The louver swing can also be set between L and B, between A and C, between B and D.

## **11.8 Protections**

### **11.8.1 Indoor Coil Defrost Protection**

During Cool Mode/Dry Mode, this protection prevents freezing of the indoor heat exchanger.  
When  $ICT \leq 0$  C for continuous 3 mins, COMP and OFAN will stop and IFAN will run at its setting speeds.

The system will resume its previous status if the protection is cleared and COMP OFF time is 3 min.  
(COMP OFF time will be 4 min during the 6 min ON and 4 min OFF cycling during Dry Mode)

### **11.8.2 Indoor Coil over Heating Protection**

During Heat Mode, this protection prevents abnormal high pressure.  
When ICT reaches 58C, OFAN will stop operating and resume operating if the ICT go to normal.

### **11.8.3 Over Current Protection**

Detect an input current by the CT during the COMP is running.  
If the current is high than 22A for continuous 3 sec, COMP and OFAN will stop, IFAN will run at setting speed.  
The system will resume its previous status if the protection is cleared and COMP stops for 3 min.

If the unit stops as such protection for 6 times,(the counter will be cleared after the compressor has run for 6min), it cannot resume running automatically and display malfunction, it can resume by pressing ON/OFF.

### **11.8.4 Outdoor Coil Deicing Protection**

This protection is for Heat Pump Only  
This protection is carried out by the cooling cycle (reverse cycle). The defrosting time or outdoor heat exchanger temperature must be more than its setting values when finishing the deicing protection.  
In the deicing protection, IFAN is forced OFF.

#### **11.8.4.1 Deicing Starting Conditions**

The starting conditions must be made with the room air temperature (RAT) and indoor coil temperature (ICT) and the trend of changing. Under the conditions that the system is in heating operation, after the time for defrosting is judged to be satisfied, the deicing operation will start.

The minimum operating time of heating mode before deicing:

- a) 40 min after 1<sup>st</sup> time of power on
- b) 5 min after system is STBY by RC or temperature condition.

**11.8.4.2 Deicing Protection Procedure**

- 1. Start to defrost: COMP stops and starts up 55S later
- 2. Start to defrost: Outdoor fan will stop after COMP stops for 50S.
- 3. Defrosting finish: COMP stops and starts up 55S later.
- 4. Defrosting finish: Outdoor fan will start up when the COMP is stopping.







**11.8.4.3 Exiting Deicing**

The deicing operation depends:

- 1. RAT & ICT and the trend of changing
- 2. The continuous running time of deicing reaches to 12min.

**11.9 Indoor Unit Controllers and Indicators**

The following shows the indicators of the indoor unit (Layout of display in HGF/HHF has some difference.)

<p>STBY/RUN INDICATOR </p>	<p>Lights up in RED in when the Air Conditioner is connected to power and the mode is STBY. Lights up in GREEN when the when the unit is turned on.</p>
<p>COOL INDICATOR           FAN INDICATOR           DRY INDICATOR           HEAT INDICATOR </p>	<p>Lights up during specified operation mode (COOL/DRY/HEAT).</p>
<p>2* 7 segments display </p>	<ul style="list-style-type: none"> <li>1. In normal situation, the setting temperature is displayed.</li> <li>2. Shows room temperature when receiving the corresponding demand from controller. When received effective RC command, setting temperature will be shown for 5 sec, and then go back to room temperature display.</li> <li>3. Shows the fault code when there is a fault(Refer to 12.1.3)</li> </ul>

## 11.10 Characteristics of sensor

### 11.10.1 RAT/OAT

RAT/OAT R-T chart

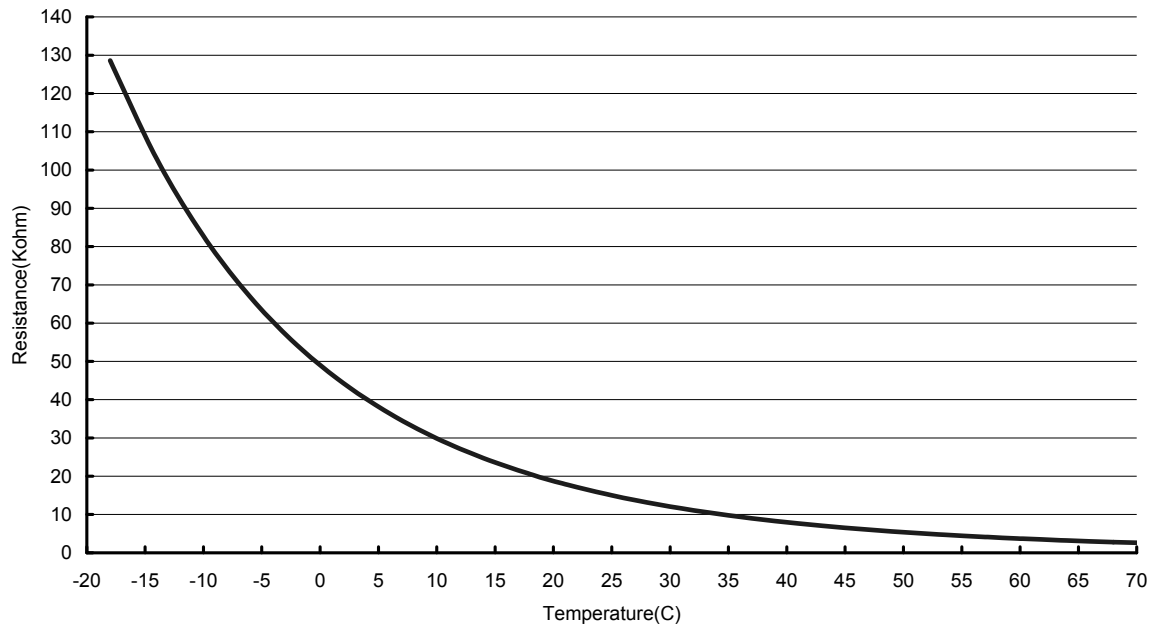

### 11.10.2 ICT/OCT

ICT/OCT R-T Chart

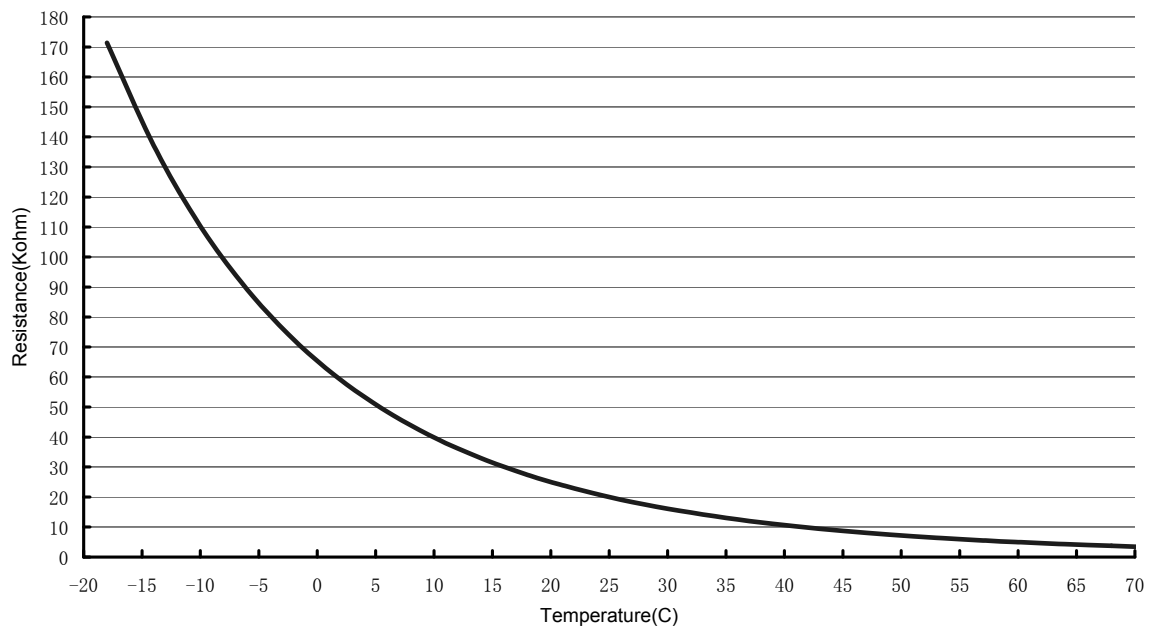

11.10.3 CTT

CTT R-T Chart

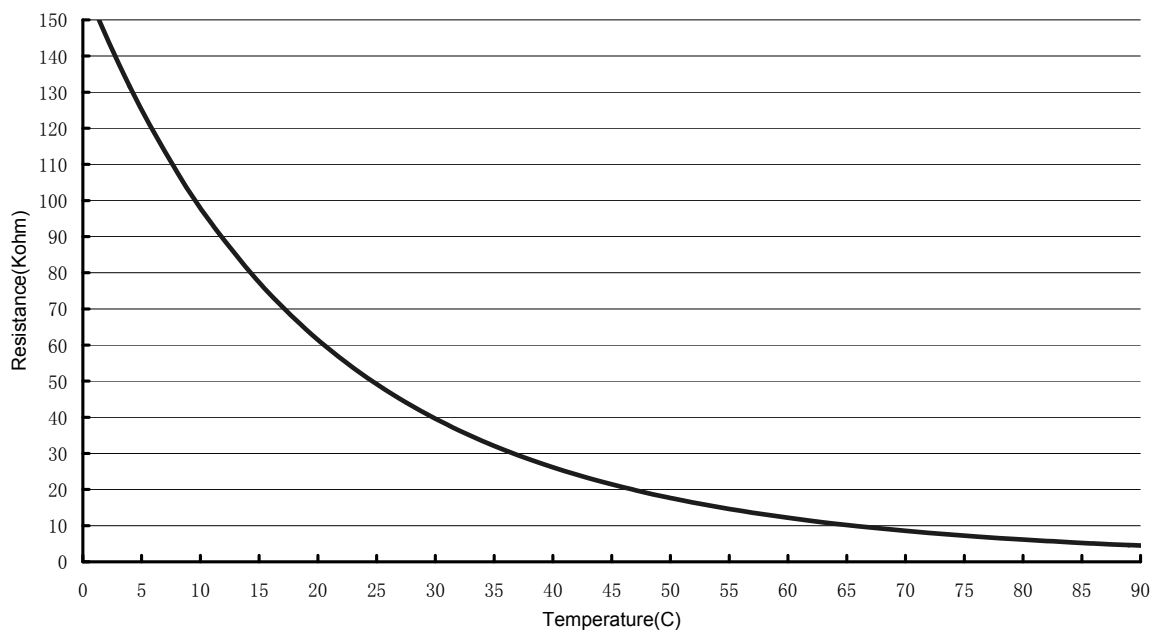

## 12. TROUBLESHOOTING

### 12.1 ELECTRICAL & CONTROL TROUBLESHOOTING

#### 12.1.1 Precautions before Performing Inspection or Repair

Be cautious during installation and maintenance. Do operation following the regulations to avoid electric shock and casualty or even death due to drop from high altitude.

\* **Static maintenance** is the maintenance during de-energization of the air conditioner. For static maintenance, make sure that the unit is de-energized and the plug is disconnected.

\***Dynamic maintenance** is the maintenance during energization of the unit. Before dynamic maintenance, check the electricity and ensure that there is ground wire on the site. Check if there is electricity on the housing and connection copper pipe of the air conditioner with voltage tester. After ensure insulation place and the safety, the maintenance can be performed.

Take sufficient care to avoid directly touching any of the circuit parts without first turning off the power. At time such as when the circuit board is to be replaced, place the circuit board assembly in a vertical position. Normally, diagnose troubles according to the trouble diagnosis procedure as described below.(Refer to the checkpoints in servicing written on the wiring diagrams attached to the indoor/outdoor units.)

#### 12.1.2 Confirmation

12.1.2.1 Confirmation of Power Supply Confirm that the power breaker operates(ON) normally;

12.1.2.2 Confirmation of Power Voltage Confirm that power voltage is AC220~240V +/- 10%. If power voltage is not in this range, the unit may not operate normally.

### 12.1.3 Judgment by Indoor/Outdoor Unit Diagnostics

If the malfunction still exists 4min later after stop of unit due to compressor protection, error code will be directly displayed though indoor display. In other situations, error code can be displayed by pressing LIGHT button 6 times within 4s.

Fault description	2* 7 segments	LEDs blinking (0.5s ON and 0.5s OFF)			Possible Reason
		RUN	COOL	HEAT	
No feedback of indoor motor	H6	11			1. IFAN motor damaged 2. IFAN motor blocked 3. IDU PCB problem
Malfunction protection of jumper cap	C5	15			Poor connection of the jumper on indoor PCB.
Zero-crossing protection (IDU)	U8	17			1. IFAN motor damaged 2. Zero-crossing circuit damaged on IDU PCB
RAT failure	F1		1		1. Sensor connection is not good 2. Sensor was broken or damaged (Refer to Sect 14 to check the sensor value)
ICT failure	F2		2		3. PCB temperature detection circuit has problem

## 12.2 Simple procedures for checking the Main Parts

### 12.2.1 Checking Mains Voltage.

Confirm that the Mains voltage is between 198 and 264 VAC. If Mains voltage is out of this range, abnormal operation of the system is expected. If in range check the Power (Circuit) Breaker and look for broken or loosed cable lugs or wiring mistake(s).

### 12.2.2 Checking Power Input.

If Indoor unit power LED is unlighted, power down the system and check the fuse of the Indoor unit. If the fuse is OK replace the Indoor unit controller. If the fuse has blown, replace the fuse and power up again.

### 12.2.3 Checking the Outdoor Fan Motor.

Run the unit in Cool/Heat/Dry mode (where the OFAN speed is high)

Check the voltage between two terminals( N and 5 ), normal voltage is 220-240VAC.

### 12.2.4 Checking the Compressor.

The compressor is rotary compressor with single-phase power input. It includes two windings of main and auxiliary. Check the resistance of terminal R and C and resistance of terminal S and C. If the windings is open or short, compressor should be replaced.

Pay attention, for the wiring connections, please refer to the wiring diagram and have double confirmation before checking the compressor.

### 12.2.5 Checking the Reverse Valve (RV).

Running in heating mode, check the voltage between two terminals( N and 4 ), normal voltage is 220-240VAC.



### 13. EXPLODED VIEW & SPARE PART LIST

#### 13.1 Exploded view of indoor unit: HGF009/HHF009

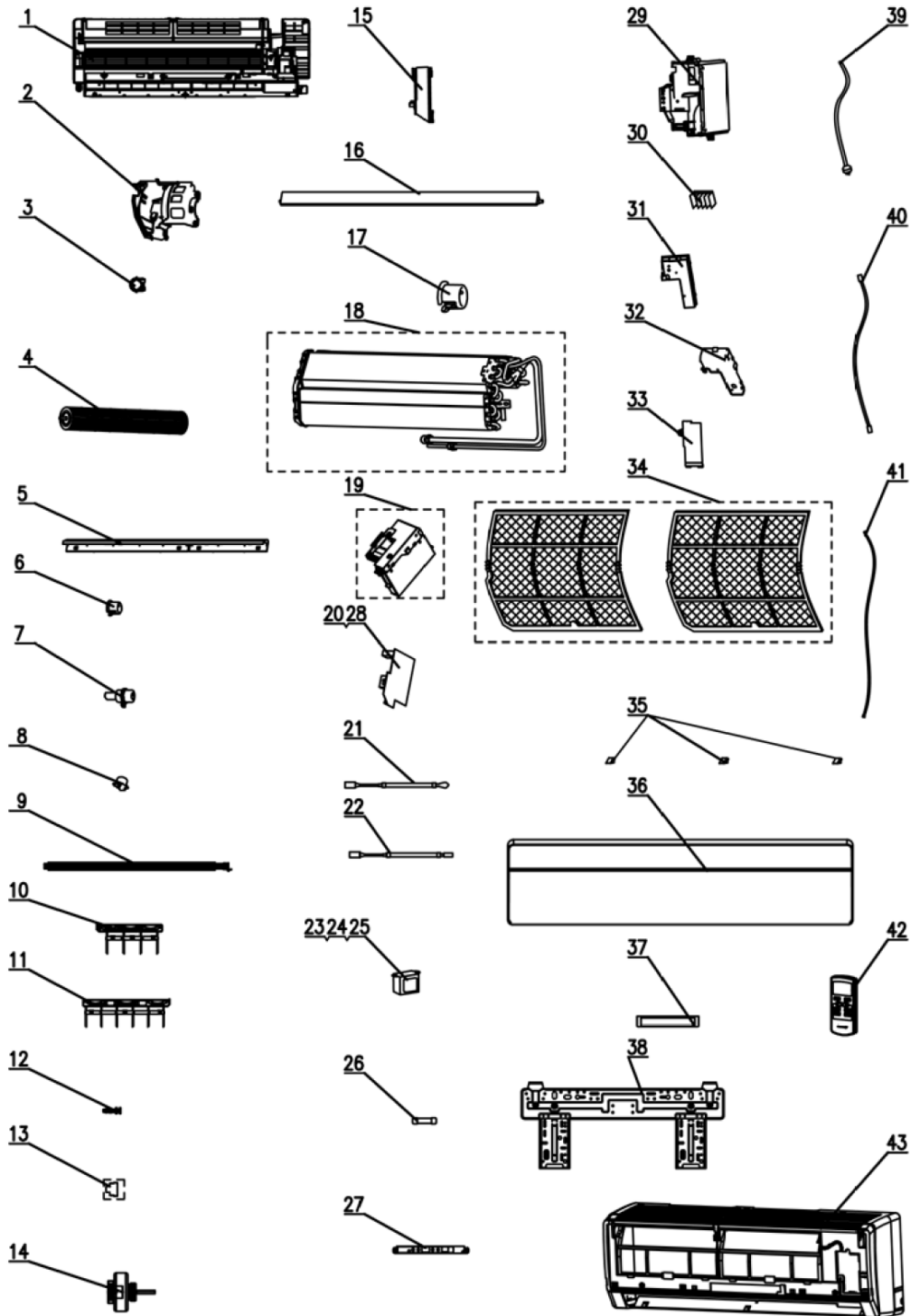

**13.2 Spare part list of indoor Unit: HGF009**

NO.	Part Code	Part Description	qty
1	22202135	Rear Case assy	1
2	26112201	Motor Press Plate	1
3	26152022	Bearing cushion rubber base	1
4	10352034	Cross Flow Fan	1
5	26112202	Helicoid tongue	1
6	10542704	Axile Bush	1
7	10582070	Crank	1
8	1521210801	Motor MP24AA	1
9	0523001408	Drainage hose	1
10	10512113	Air Louver 1	1
11	10512114	Swing Louver	1
12	76712012	Water Tray Glue Plug	1
13	76512051	O-Gasket sub-assy of Bearing	1
14	15012115	Motor	1
15	26112199	Pipe Clamp	1
16	10512162	Guide Louver	1
17	10542008	Axile Bush (guide louver)	1
18	0100257702	Evaporator Assy	1
19	2020227302	Electric Box Assy	1
20	30135353	Main Board	1
21	390000453	Ambient Temperature Sensor	1
22	390000591	Tube Sensor (20K black)	1
23	None	Relay	0
24	None	Relay	0
25	None	Relay	0
26	46010055	Fuse	1
27	30565127	Display Board	1
28	4202300114	Jumper	1
29	20112091	Electric Box	1
30	42010262	Terminal Board	1
31	20122114	Electric Box Cover	1
32	01592080	Shield box (electric box)	1
33	20122075	Electric Box Cover2	1
34	11122095	Filter Sub-Assy	2
35	24252016	Screw Cover	3
36	20012833	Front Panel Assy	1
37	None	Decorate Piece	0
38	01252231	Wall Mounting Frame	1
39	400220113	Power cord Sub-Assy	1
40	40020540	Connecting Cable	1
41	40020536	Connecting Cable	1
42	30510065	Remote controller YX1F	1
43	20012396	Front Case	1
	111220071	Photocatalysis Filter	1
	11012025	Air Cleaner	1

**13.3 Spare part list of indoor Unit: HHF009**

NO.	Part Code	Part Description	qty
1	2220213501	Rear Case assy	1
2	26112201	Motor Press Plate	1
3	26152022	Bearing cushion rubber base	1
4	10352034	Cross Flow Fan	1
5	26112202	Helicoid tongue	1
6	10542704	Axile Bush	1
7	10582070	Crank	1
8	1521210801	Motor MP24AA	1
9	0523001408	Drainage hose	1
10	10512113	Air Louver 1	1
11	10512114	Swing Louver	1
12	76712012	Water Tray Glue Plug	1
13	76512051	O-Gasket sub-assy of Bearing	1
14	15012115	Motor	1
15	26112199	Pipe Clamp	1
16	10512162	Guide Louver	1
17	10542008	Axile Bush (guide louver)	1
18	0100257702	Evaporator Assy	1
19	20202933	Electric Box Assy	1
20	30135353	Main Board	1
21	390000453	Ambient Temperature Sensor	1
22	390000591	Tube Sensor (20K black)	1
23	None	Relay	0
24	None	Relay	0
25	None	Relay	0
26	46010055	Fuse	1
27	30565156	Display Board	1
28	4202300114	Jumper	1
29	20112091	Electric Box	1
30	42010262	Terminal Board	1
31	20122114	Electric Box Cover	1
32	01592080	Shield box (electric box)	1
33	20122075	Electric Box Cover2	1
34	11122095	Filter Sub-Assy	2
35	24252016	Screw Cover	3
36	20012879	Front Panel Assy	1
37	None	Decorative Strip	0
38	01252231	Wall Mounting Frame	1
39	400220113	Power cord Sub-Assy	1
40	40020540	Connecting Cable	1
41	40020536	Connecting Cable	1
42	30510065	Remote controller YX1F	1
43	2001239601	Front Case	1
	11012025	Air Cleaner	1
	111220071	Photocatalysis Filter	1

13.4 Exploded view of indoor unit: HGF012/HHF012

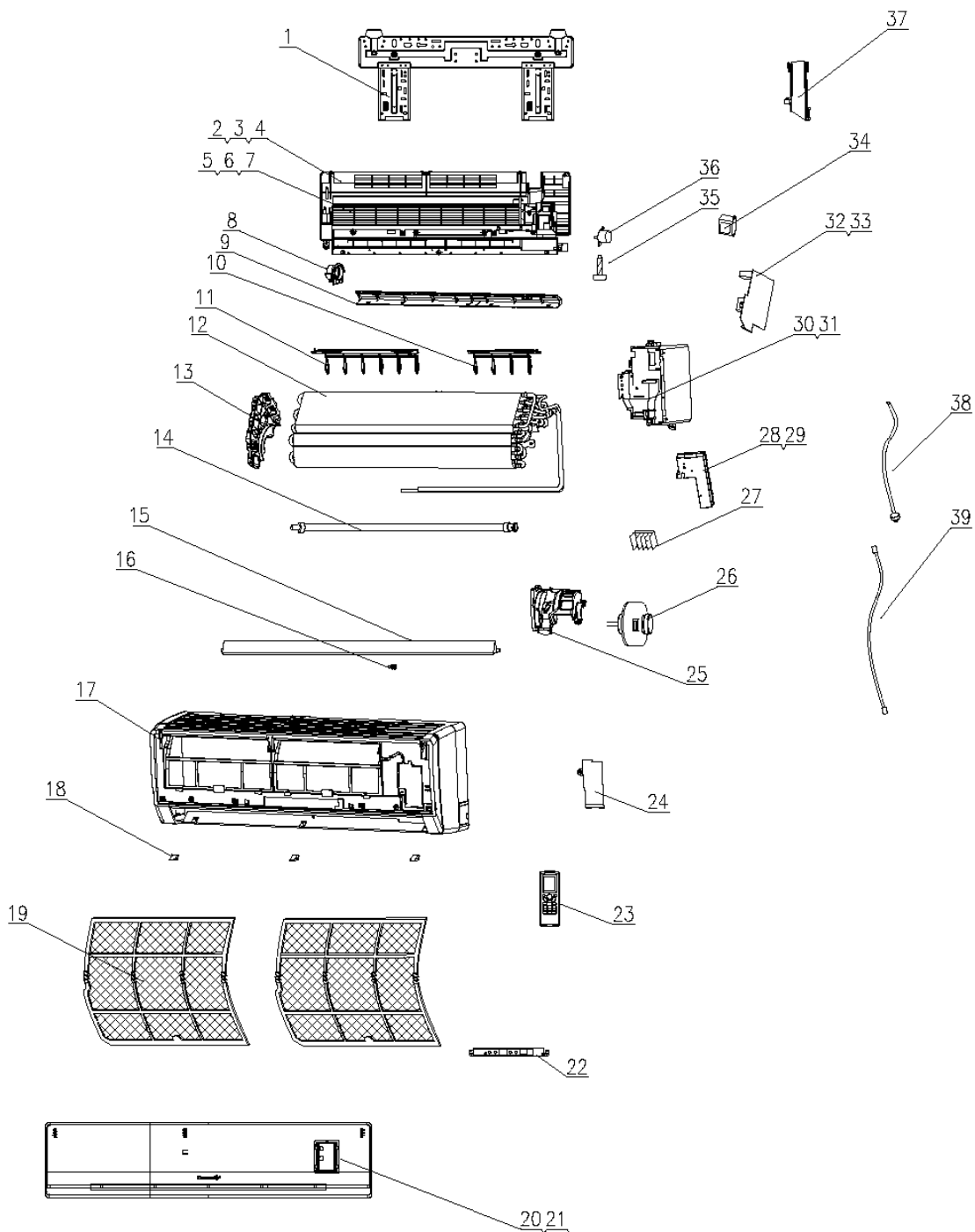

**13.5 Spare part list of indoor Unit: HGF012**

NO.	Part Code	Part Description	qty
1	01252015	Wall-Mounting Frame	1
2	2220210101	Rear Case assy	1
3	10542704	Axile Bush	1
4	10582070	Crank	1
5	10352018	Cross Flow Fan	1
6	76512051	O-Gasket sub-assy of Bearing	1
7	76512203	O-Gasket of Cross Fan Bearing	1
8	26152022	Bearing cushion rubber base	1
9	26112162	Helicoid tongue	1
10	10512114	Swing Louver	1
11	10512113	Air Louver 1	1
12	0100255213	Evaporator Assy	1
13	24212090	Evaporator Support	1
14	0523001406	Drainage hose	1
15	10512111	Guide Louver1	1
16	10542008	Axile Bush (guide louver)	1
17	20012179	Front Case	1
18	24252016	Screw Cover	1
19	11122081	Filter Sub-Assy	2
20	20012834	Front Panel Assy	1
21	none	Receiver Window	0
22	30565127	Display Board	1
23	30510065	Remote controller YX1F	1
24	20122075	Electric Box Cover2	1
25	26112160	Motor Clamp	1
26	15012115	Motor	1
27	42010262	Terminal Board	1
28	20122103	Electric Box Cover1	1
29	0159207301	Shield cover of Electric Box sub-assy	1
30	2020238803	Electric Box Assy	1
31	20112082	Electric Box	1
32	30135283	Main Board	1
33	43110236	Transformer 41X26.5G	1
34	4202300128	Jumping Connector	1
35	76712012	Water Tray Glue Plug	1
36	1521210801	Motor MP24AA	1
37	26112164	Pipe Clamp	1
38	4002046413	Power Cord	1
39	40020540	Connecting Cable	1
	40020536	Connecting Cable	1
	390000591	Tube Sensor (20K black)	1
	42020063	Sensor Insert	1
	390000453	Ambient Temperature Sensor	1
	11012025	Air Cleaner	1
	111220071	Photocatalysis Filter	1

## 13.6 Spare part list of indoor Unit: HHF012

NO.	Part Code	Part Description	qty
1	01252015	Wall-Mounting Frame	1
2	2220210101	Rear Case assy	1
3	10542704	Axile Bush	1
4	10582070	Crank	1
5	10352018	Cross Flow Fan	1
6	76512051	O-Gasket sub-assy of Bearing	1
7	76512203	O-Gasket of Cross Fan Bearing	1
8	26152022	Bearing cushion rubber base	1
9	26112162	Helicoid tongue	1
10	10512114	Swing Louver	1
11	10512113	Air Louver 1	1
12	0100255213	Evaporator Assy	1
13	24212090	Evaporator Support	1
14	0523001406	Drainage hose	1
15	10512111	Guide Louver1	1
16	10542008	Axile Bush (guide louver)	1
17	20012120	Front Case	1
18	24252016	Screw Cover	1
19	11122081	Filter Sub-Assy	2
20	20012880	Front Panel Assy	1
21	none	Receiver Window	0
22	30565156	Display Board	1
23	30510065	Remote controller YX1F	1
24	20122075	Electric Box Cover2	1
25	26112160	Motor Clamp	1
26	15012115	Motor	1
27	42010262	Terminal Board	1
28	20122103	Electric Box Cover1	1
29	0159207301	Shield cover of Electric Box sub-assy	1
30	2020226601	Electric Box Assy	1
31	20112082	Electric Box	1
32	30135283	Main Board	1
33	43110236	Transformer 41X26.5G	1
34	4202300128	Jumping Connector	1
35	76712012	Water Tray Glue Plug	1
36	1521210801	Motor MP24AA	1
37	26112164	Pipe Clamp	1
38	4002046413	Power Cord	1
39	40020536	Connecting Cable	0
	40020540	Connecting Cable	1
	390000591	Tube Sensor (20K black)	1
	42020063	Sensor Insert	1
	390000453	Ambient Temperature Sensor	1

13.7 Exploded view of indoor unit: HGF018

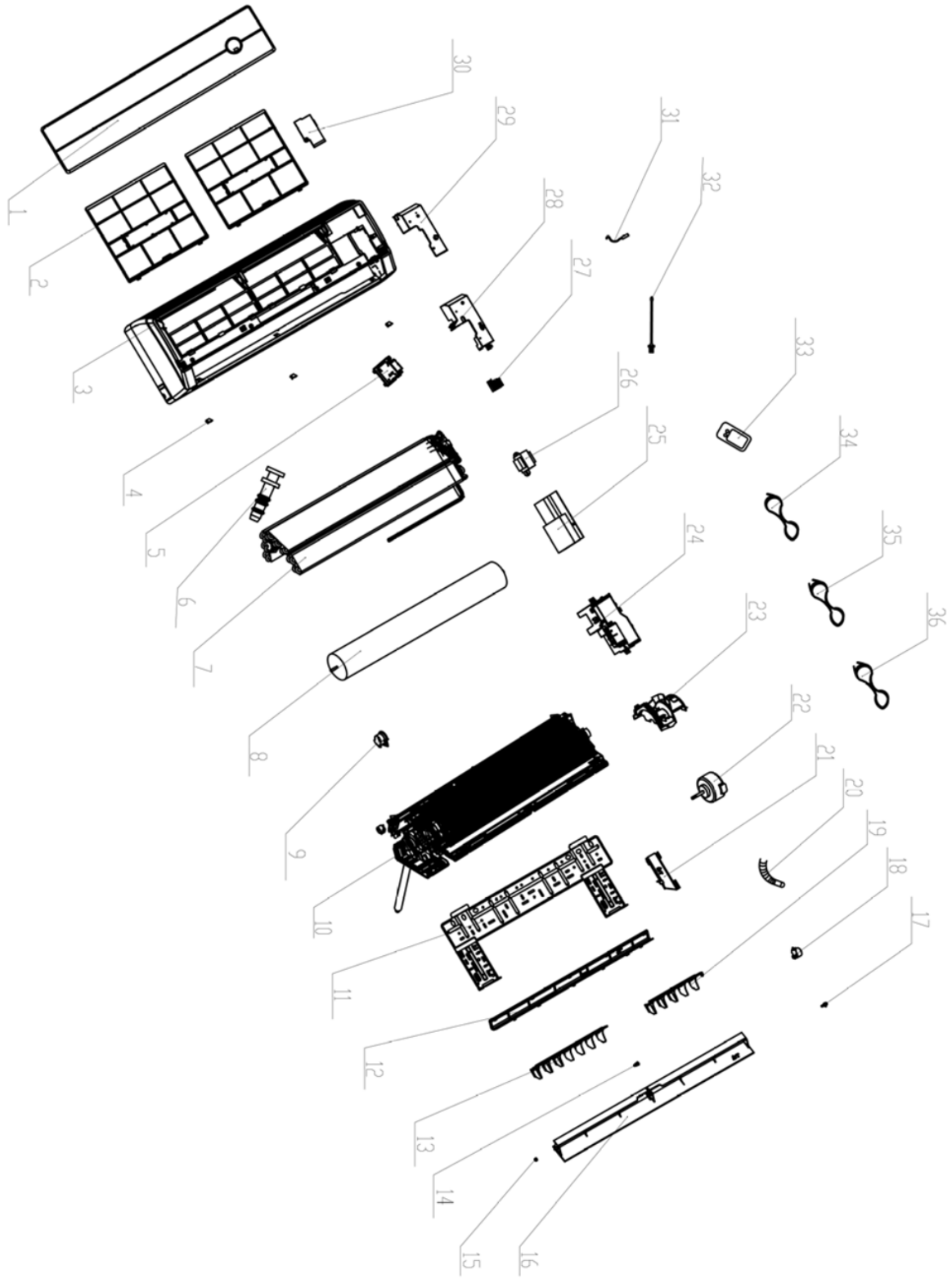

## 13.8 Spare part list of indoor Unit: HGF018

NO.	Part Code	Part Description	qty
1	2001246601_K46462	Front Panel Assy	1
2	1112208901	Filter Sub-assy	2
3	20012766	Front Case Sub-Assy	1
4	24252016	Screw Cover	3
5	30565127	Display Board	1
6	76712012	Water Tray Glue Plug	1
7	01002590	Evaporator Assy	1
8	10352019	Cross Flow Fan	1
9	26152022	Bearing cushion rubber base	1
10	12312214	Rear Case assy	1
11	01252218	Wall Mounting Frame	1
12	26112238	Helicoid tongue	1
13	10512116	Air Louver 1	1
14	10542008	Axile Bush (guide louver)	1
15	10512037	Left Axile Bush	1
16	10512115	Guide Louver	1
17	10582070	Crank	1
18	15012086	Step Motor	1
19	10512117	Air Louver 2	1
20	05230014	Drain Pipe	1
21	26112164	Pipe Clamp	1
22	15012116	Motor	1
23	26112178	Motor Press Plate	1
24	20202703	Electric Box Assy	1
25	30135228	Mian board	1
26	43110237	Transformer 57X25C	1
27	42010268	Terminal board	1
28	20122128	Electric Box Cover1	1
29	01592092	Shield cover of Electric Box	1
30	20112081	Electric Box cover 2	1
31	390000591	Tube Sensor (20K black)	1
32	390000451	Ambient Temperature Sensor	1
33	30510065	Remote controller YX1F	1
34	400205402	Connecting Cable	0
35	4002053603	Connecting Cable	0
36	none	Power Cord	0
	11012025	Air Cleaner	1
	4202300109	Jumper	1
	20122122	Display Cover	1
	24212100	Evaporator Support	1
	76512051	O-Gasket sub-assy of Bearing	1
	111220071	Photocatalysis Filter	1



13.9 Exploded view of indoor unit: HHF018, HHF024

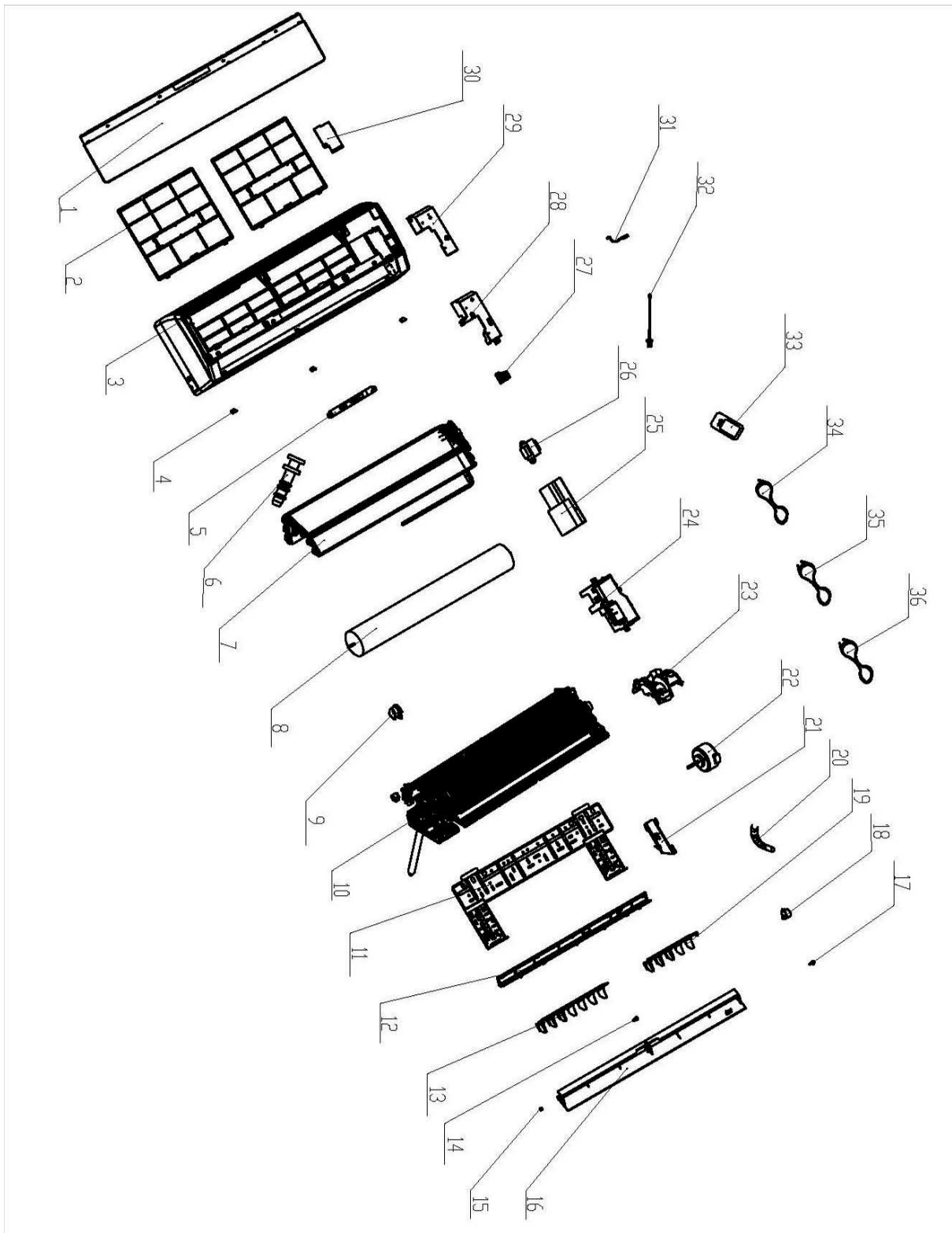

## 13.10 Spare part list of indoor Unit: HHF018

NO.	Part Code	Part Description	qty
1	2001228601	Front Panel Assy	1
2	1112208901	Filter Sub-assy	2
3	20012288	Front Case Sub-Assy	1
4	24252016	Screw Cover	3
5	30565156	Display Board	1
6	76712012	Water Tray Glue Plug	1
7	20112081	Electric Box cover 2	1
8	10352019	Cross Flow Fan	1
9	26152022	Bearing cushion rubber base	1
10	12312214	Rear Case assy	1
11	01252218	Wall Mounting Frame	1
12	26112238	Helicoid tongue	1
13	10512116	Air Louver 1	1
14	10542008	Axile Bush (guide louver)	1
15	10512037	Left Axile Bush	1
16	10512115	Guide Louver	1
17	10582070	Crank	1
18	15012086	Step Motor	1
19	10512117	Air Louver 2	1
20	05230014	Drain Pipe	1
21	26112164	Pipe Clamp	1
22	15012116	Motor	1
23	26112178	Motor Press Plate	1
24	20112108	Electric Box	1
25	30135228	Mian board	1
26	43110237	Transformer 57X25C	1
27	42010268	Terminal board	1
28	20202914	Electric Box Assy	1
29	01592092	Shield cover of Electric Box	1
30	20122128	Electric Box Cover1	1
31	390000591	Tube Sensor (20K black)	1
32	390000451	Ambient Temperature Sensor	1
33	30510065	Remote controller YX1F	1
34	400205402	Connecting Cable	0
35	4002053603	Connecting Cable	0
36	4002048716	Power Cord	1
	76512203	O-Gasket of Cross Fan Bearing	1
	4202300109	Jumper	1
	01002590	Evaporator Assy	1
	24212100	Evaporator Support	1
	76512051	O-Gasket sub-assy of Bearing	1
	26112228	Baffle Plate	1
	49010104	Magnetic Ring	1
	42020063	Sensor Insert	1

**13.11 Spare part list of indoor Unit: HHF024**

NO.	Part Code	Part Description	qty
1	2001228601	Front Panel Assy	1
2	1112208901	Filter Sub-assy	2
3	20012288	Front Case Sub-Assy	1
4	24252016	Screw Cover	3
5	30565156	Display Board	1
6	76712012	Water Tray Glue Plug	1
7	20112081	Electric Box cover 2	1
8	10352019	Cross Flow Fan	1
9	26152022	Bearing cushion rubber base	1
10	12312214	Rear Case assy	1
11	01252218	Wall Mounting Frame	1
12	26112238	Helicoid tongue	1
13	10512116	Air Louver 1	1
14	10542008	Axile Bush (guide louver)	1
15	10512037	Left Axile Bush	1
16	10512115	Guide Louver	1
17	10582070	Crank	1
18	15012086	Step Motor	1
19	10512117	Air Louver 2	1
20	05230014	Drain Pipe	1
21	26112164	Pipe Clamp	1
22	15012116	Motor	1
23	26112178	Motor Press Plate	1
24	20112108	Electric Box	1
25	30135295	Main Board	1
26	43110237	Transformer 57X25C	1
27	4201026201	Terminal Board	1
28	20202909	Electric Box Assy	1
29	01592092	Shield cover of Electric Box	1
30	20122128	Electric Box Cover1	1
31	390000591	Tube Sensor (20K black)	1
32	390000451	Ambient Temperature Sensor	1
33	30510065	Remote controller YX1F	1
34	400205382	Connecting Cable	0
35	4002053603	Connecting Cable	1
36	400203253	Power Wire	1
	4202300109	Jumper	1
	76512203	O-Gasket of Cross Fan Bearing	1
	42020063	Sensor Insert	1
	76512051	O-Gasket sub-assy of Bearing	1
	49010104	Magnetic Ring	1
	11012025	Air Cleaner	1
	01002590	Evaporator Assy	1
	24212100	Evaporator Support	1
	26112228	Baffle Plate	1

13.12 Exploded view of indoor unit: HGF024

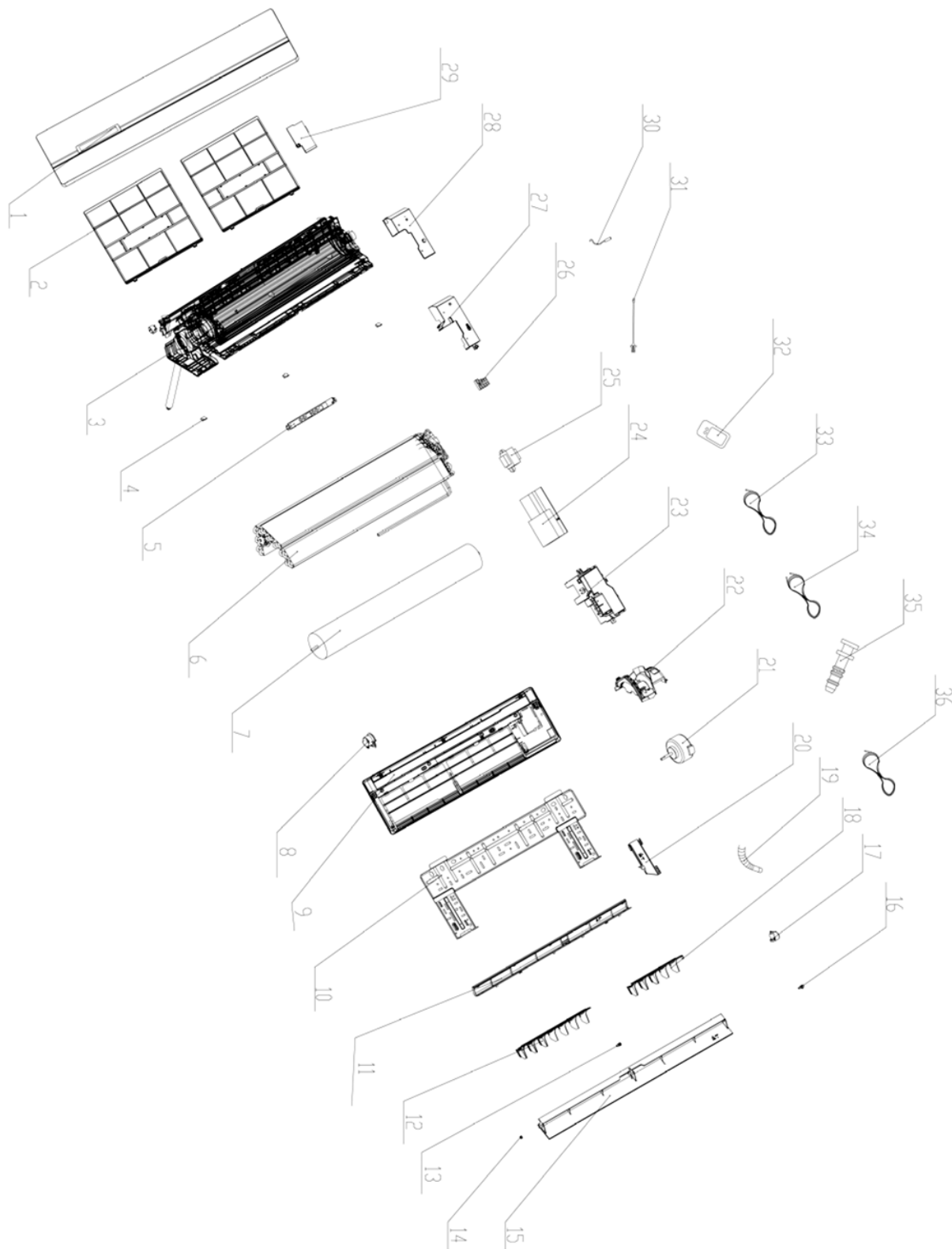

**13.13 Spare part list of indoor Unit: HGF024**

NO.	Part Code	Part Description	qty
1	2001246601_K46462	Front Panel Assy	1
2	1112208901	Filter Sub-assy	2
3	12312214	Rear Case assy	1
4	24252016	Screw Cover	3
5	30565127	Display Board	1
6	01002590	Evaporator Assy	1
7	10352019	Cross Flow Fan	1
8	26152022	Bearing cushion rubber base	1
9	20012766	Front Case Sub-Assy	1
10	01252218	Wall Mounting Frame	1
11	26112238	Helicoid tongue	1
12	10512116	Air Louver 1	1
13	10542008	Axile Bush (guide louver)	1
14	10512037	Left Axile Bush	1
15	10512115	Guide Louver	1
16	10582070	Crank	1
17	15012086	Step Motor	1
18	10512117	Air Louver 2	1
19	05230014	Drain Pipe	1
20	26112164	Pipe Clamp	1
21	15012116	Motor	1
22	26112178	Motor Press Plate	1
23	20202720	Electric Box Assy	1
24	30135295	Main Board	1
25	43110237	Transformer 57X25C	1
26	4201026201	Terminal Board	1
27	20122128	Electric Box Cover1	1
28	01592092	Shield cover of Electric Box	1
29	20112081	Electric Box cover 2	1
30	390000591	Tube Sensor (20K black)	1
31	390000451	Ambient Temperature Sensor	1
32	30510065	Remote controller YX1F	1
33	4002053603	Connecting Cable	1
34	400203253	Power Wire	1
35	76712012	Water Tray Glue Plug	1
36	400205382	Connecting Cable	1
	20122122	Display Cover	1
	24212100	Evaporator Support	1
	76512051	O-Gasket sub-assy of Bearing	1
	20012767	Front Case	1
	76512203	O-Gasket of Cross Fan Bearing	1
	49010252	Radiator	1
	33010043	Capacitor	1
	22202158	Rear Case	1
	26112228	Baffle Plate	1
	111220071	Photocatalysis Filter	1
	11012025	Air Cleaner	1
	4202300109	Jumper	1
	76512210	Fan Bearing	1

13.14 Exploded view of outdoor unit: YGF009, YGF012

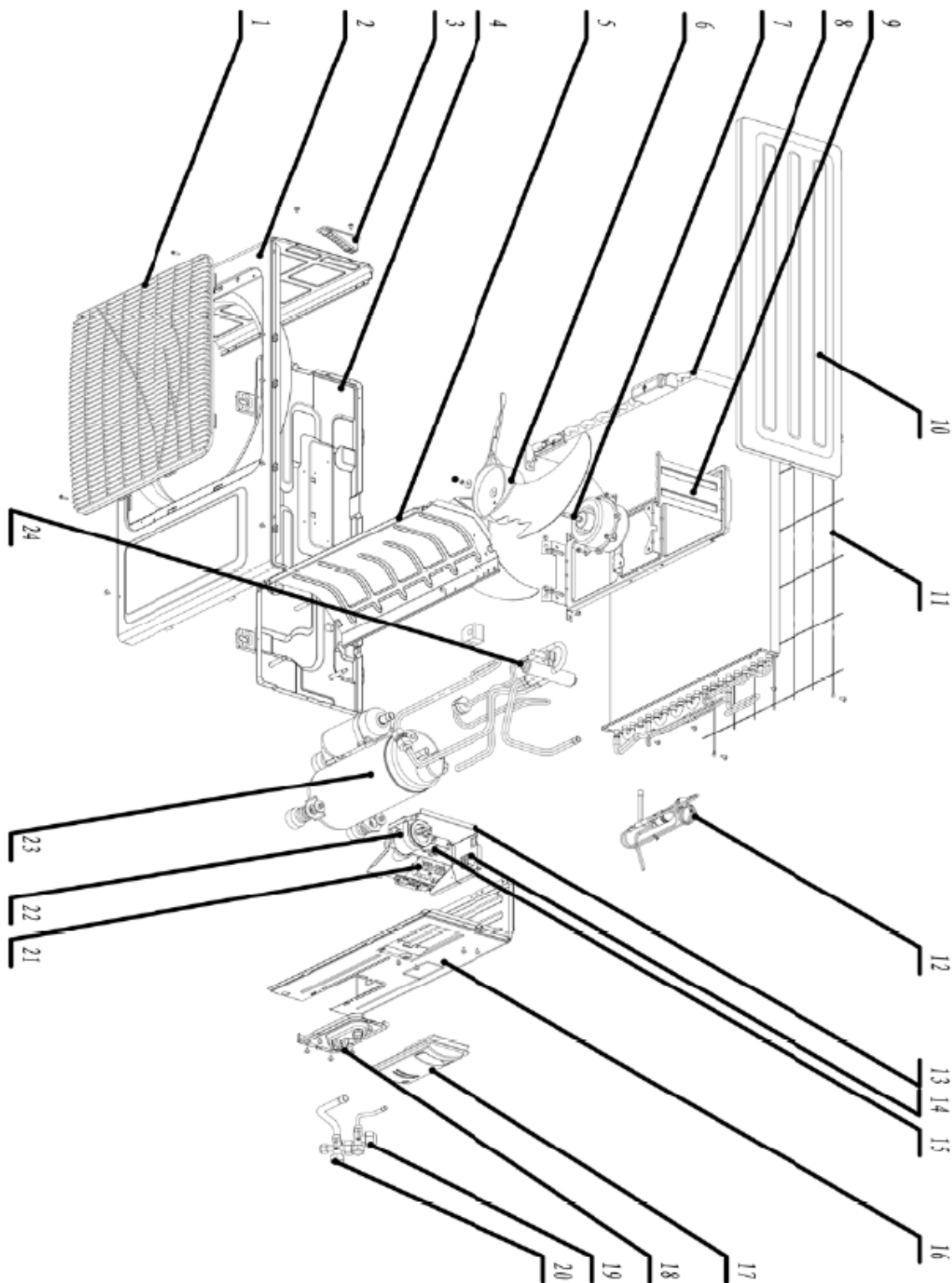

**13.15 Spare part list of outdoor Unit: YGF009**

NO.	Part Code	Part Description	qty
1	22413007	Grille	1
2	01533029P	Front panel	1
3	26233100	Small Handle	1
4	01203799P	Chassis Sub-assy	1
5	01233066	Isolation Sheet	1
6	10333427	Axial Flow Fan	1
7	150130671	Fan Motor	1
8	0111347201	Condenser Assy	1
9	01703052	Motor Support Assy	1
10	01253031	Top Cover Sub-Assy	1
11	1112320501	Grill	1
12	0306301701	Capillary Sub-Assy	1
13	02603240	Electric Box Assy	1
14	42010265	Terminal Board	1
15	33010026	Capacitor CBB61 2.5uF/450V	1
16	01303183	Right Side Plate Sub-Assy	1
17	26233433	Big Handle	1
18	0170308901P	Valve Support	1
19	07100003	Cut-off Valve (1/4)	1
20	07100005	Cut-off Valve (3/8)	1
21	40040007_GY1	Terminal Board	1
22	33000018	Capacitor	1
23	00103203	Compressor and fittings	1
24	0312328601	4-way Valve Assy	1
	0130304802	Right Side Plate	1
	430004022	4-Way Valve	1
	430004002	4-way Valve Accessary	1
	06123401	Drainage Connector	1
	00183012	Overload Protector	1
	76710217	Compressor Gasket AD7070837	3

**13.16 Spare part list of outdoor Unit: YGF012**

NO.	Part Code	Part Description	qty
1	22413007	Grille	1
2	01533029P	Front panel	1
3	26233100	Small Handle	1
4	01203767P	Chassis Sub-assy	1
5	01233066	Isolation Sheet	1
6	10333427	Axial Flow Fan	1
7	150130676	Fan Motor	1
8	01113449	Condenser Assy	1
9	01703052	Motor Support Assy	1
10	01253031	Top Cover Sub-Assy	1
11	1112320501	Grill	1
12	03103997	Capillary Sub-Assy	1
13	01403947	Electric Plate	1
14	42010265	Terminal Board	1
15	33010743	Capacitor CBB65	1
16	01303183	Right Side Plate Sub-Assy	1
17	26233433	Big Handle	1
18	0170308901P	Valve Support	1
19	07100006	Cut-off Valve	1
20	07100003	Cut-off Valve (1/4)	1
21	42011147	Terminal Board	1
22	33010026	Capacitor CBB61 2.5uF/450V	1
23	00103281	Compressor and fittings	1
24	03123592	03123592	1
	430004002	4-way Valve Accessary	1
	0130304802	Right Side Plate	1
	06123401	Drainage Connector	1
	430004032	4-way Valve	1



13.17 Exploded view of outdoor unit: YGF018

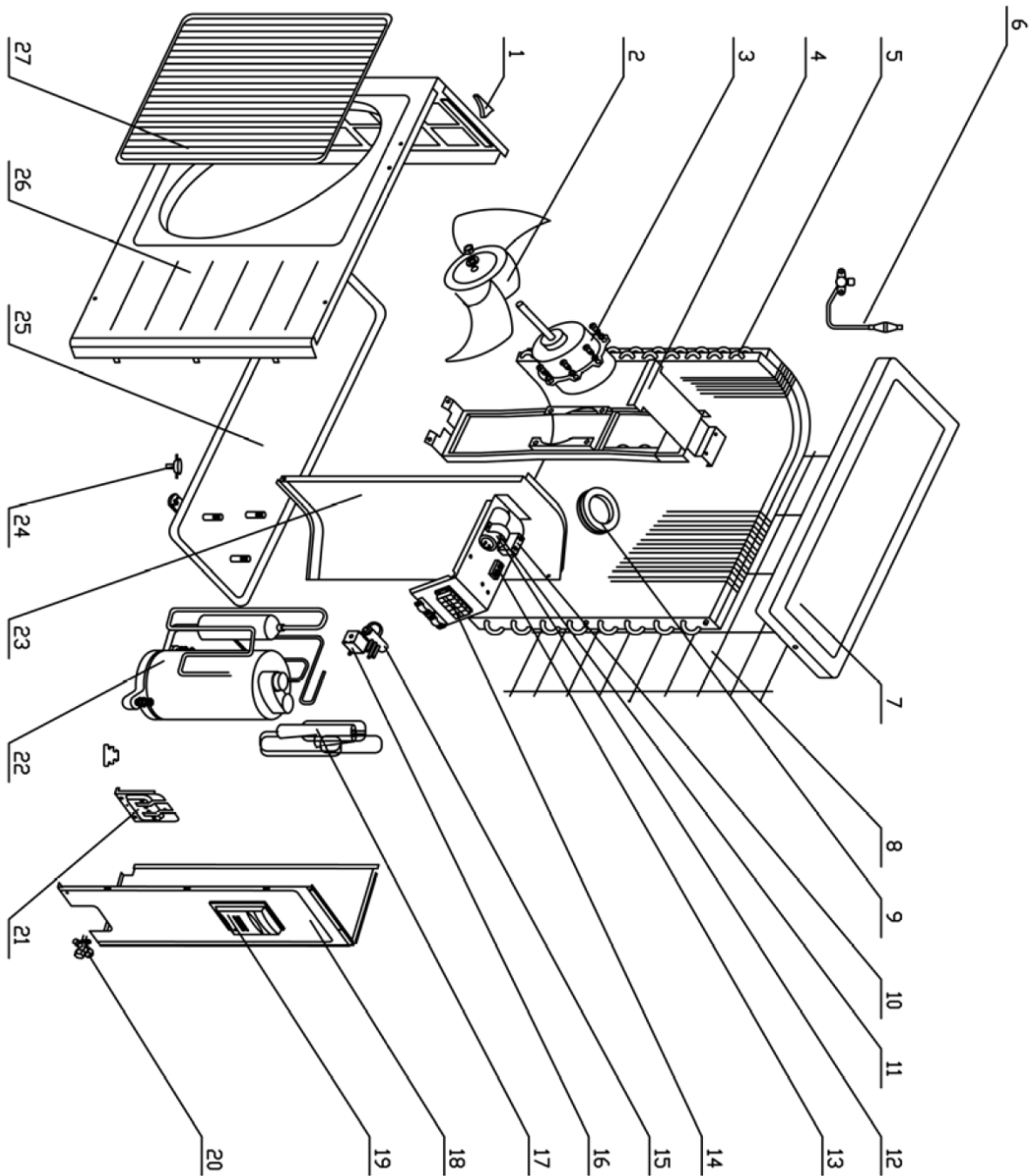

**13.18 Spare part list of outdoor Unit: YGF018**

NO.	Part Code	Part Description	qty
1	26235401	Small Handle	1
2	10335257	Axial-flow Fan	1
3	15015057	Fan Motor	1
4	0170510702	Motor Support Sub-Assy	1
5	01113238	Condenser Assy	1
6	07130213	Gas Valve Assy	1
7	01255001	Top Cover	1
8	01475004	Rear grill	1
9	06813401	Choke Plug	3
10	33000039	Capacitor	1
11	02603068	Electric Box Assy	1
12	33010026	Capacitor CBB61 2.5uF/450V	1
13	42011147	Terminal Board	1
14	42010265	Terminal Board	1
15	03023870	4-way Valve Assy	1
16	430004002	4-way Valve Accessary	1
17	03103780	Capillary Sub-Assy	1
18	01305013	Right Side Plate	1
19	26235254	Handle	1
20	07100003	Cut-off Valve (1/4)	1
21	01713075	Valve Support Sub-Assy	1
22	00103007	Compressor and Fittings	1
23	01233035	Clapboard Sub-Assy	1
24	06123401	Drainage Connector	1
25	0120362602P	Chassis	1
26	01305015	Front Side Plate	1
27	22415001	Front Grill	1
	76710202	Compressor Gasket 4CYC00008	3
	430004032	4-way Valve	1
	07210022	Filter	1
	01705003	Motor Support	1
	07245007	Silencer Mounting	1
	00180252	Overload Protector	1

13.19 Exploded view of outdoor unit: YGF024

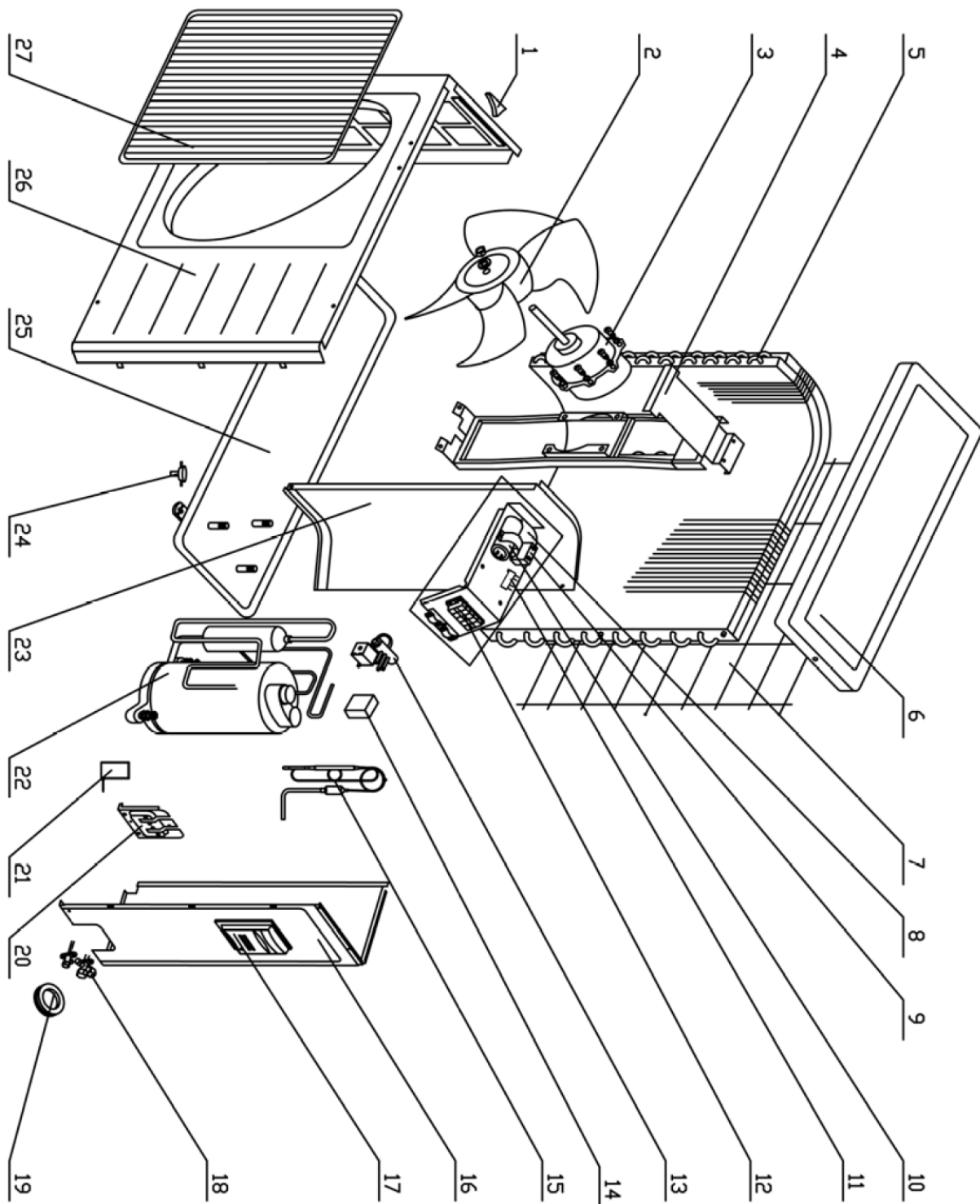

## 13.20 Spare part list of outdoor Unit: YGF024

NO.	Part Code	Part Description	qty
1	26235401	Small Handle	1
2	10335257	Axial-flow Fan	1
3	15015057	Fan Motor	1
4	0170305901	Motor Support Sub-Assy	1
5	01113396	Condenser Assy	1
6	01255001	Top Cover	1
7	0147500401	Rear Grill	1
8	02603219	Electric Box Assy	1
9	33000039	Capacitor	1
10	33010027	Capacitor CBB611A(3uF/450V)	1
11	42011147	Terminal Board	1
12	420101941	Terminal Board	1
13	03123248	4-way Valve Assy	1
14	00180157	Overload Protector	1
15	03103946	Capillary Sub-Assy	1
16	01305013	Right Side Plate	1
17	26235254	Handle	1
18	07130213	Gas Valve Assy	1
19	06813401	Choke Plug	3
20	01713075	Valve Support Sub-Assy	1
21	430004002	4-way Valve Accessary	1
22	00103702	Compressor and Fittings	1
23	01233035	Clapboard Sub-Assy	1
24	06123401	Drainage Connector	1
25	0120362602P	Chassis	1
26	01305015	Front Side Plate	1
27	22415001	Front Grill	1
	02141375	Capacitor Clamp	1
	07245007	Silencer Mounting	1
	44010245	AC Contactor CJX9B-25S/D	1
	430004032	4-way Valve	1
	76710202	Compressor Gasket 4CYC00008	3
	07100003	Cut-off Valve (1/4)	1

# APPENDIX