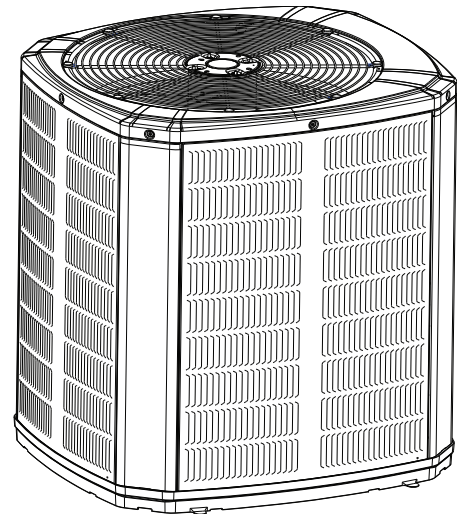


# Installer's Guide

## Variable Speed AccuLink™ System Heat Pumps and Air Conditioners

4A6V8024A1000A  
4A6V8036A1000A  
4A6V8037A1000A  
4A6V8048A1000A  
4A6V8049A1000A  
4A6V8060A1000A

4A7V8024A1000A  
4A7V8036A1000A  
4A7V8037A1000A  
4A7V8048A1000A  
4A7V8060A1000A



*Note: "Graphics in this document are for representation only. Actual model may differ in appearance."*



Scan to see help  
videos on this  
product

### ⚠ SAFETY WARNING

Only qualified personnel should install and service the equipment. The installation, starting up, and servicing of heating, ventilating, and air-conditioning equipment can be hazardous and requires specific knowledge and training. Improperly installed, adjusted or altered equipment by an unqualified person could result in death or serious injury. When working on the equipment, observe all precautions in the literature and on the tags, stickers, and labels that are attached to the equipment.

## SAFETY SECTION – OUTDOOR

**Important** — This document contains a wiring diagram and service information. This is customer property and is to remain with this unit. Please return to service information pack upon completion of work.

### **⚠ WARNING**

#### **HAZARDOUS VOLTAGE!**

Failure to follow this Warning could result in property damage, severe personal injury, or death. Disconnect all electric power, including remote disconnects before servicing. Follow proper lockout/tagout procedures to ensure the power cannot be inadvertently energized.

### **⚠ WARNING**

#### **REFRIGERANT OIL!**

Any attempt to repair a central air conditioning product may result in property damage, severe personal injury, or death. These units use R-410A refrigerant which operates at 50 to 70% higher pressures than R-22. Use only R-410A approved service equipment. Refrigerant cylinders are painted a "Rose" color to indicate the type of refrigerant and may contain a "dip" tube to allow for charging of liquid refrigerant into the system. All R-410A systems with variable speed compressors use a PVE oil that readily absorbs moisture from the atmosphere. To limit this "hygroscopic" action, the system should remain sealed whenever possible. If a system has been open to the atmosphere for more than 4 hours, the compressor oil must be replaced. Never break a vacuum with air and always change the driers when opening the system for component replacement.

### **⚠ CAUTION**

#### **HOT SURFACE!**

May cause minor to severe burning. Failure to follow this Caution could result in property damage or personal injury. Do not touch top of compressor.

### **⚠ CAUTION**

#### **CONTAINS REFRIGERANT!**

Failure to follow proper procedures can result in personal illness or injury or severe equipment damage. System contains oil and refrigerant under high pressure. Recover refrigerant to relieve pressure before opening system.

### **⚠ CAUTION**

#### **GROUNDING REQUIRED!**

Failure to inspect or use proper service tools may result in equipment damage or personal injury. Reconnect all grounding devices. All parts of this product that are capable of conducting electrical current are grounded. If grounding wires, screws, straps, clips, nuts, or washers used to complete a path to ground are removed for service, they must be returned to their original position and properly fastened.

### **⚠ WARNING**

#### **SERVICE VALVES!**

Failure to follow this warning will result in abrupt release of system charge and may result in personal injury and/or property damage. Extreme caution should be exercised when opening the Liquid Line Service Valve. Turn valve stem counterclockwise only until the stem contacts the rolled edge. No torque is required.

### **⚠ WARNING**

#### **BRAZING REQUIRED!**


Failure to inspect lines or use proper service tools may result in equipment damage or personal injury. If using existing refrigerant lines make certain that all joints are brazed, not soldered.

### **⚠ WARNING**

#### **HIGH LEAKAGE CURRENT!**

Failure to follow this Warning could result in property damage, severe personal injury, or death. Earth connection essential before connecting electrical supply.


**⚠ WARNING**

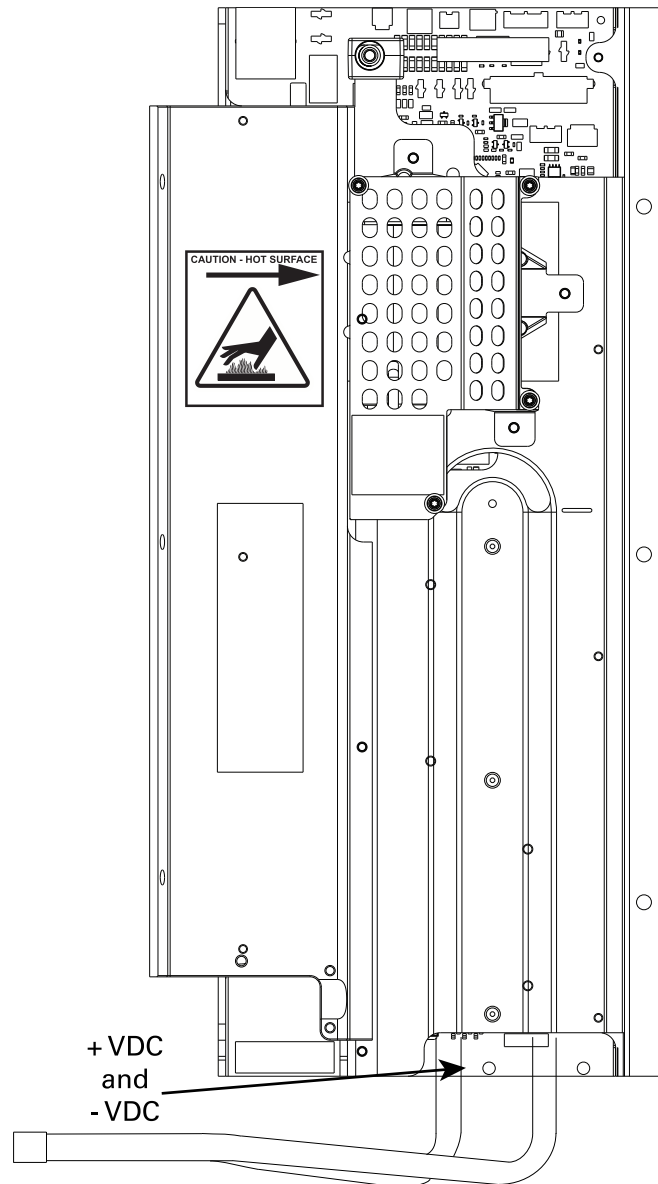


**400 VOLTS  
ELECTRICAL HAZARD**

Failure to follow this warning could result in personal injury or death.

WAIT TWO (2) MINUTES after disconnecting power prior to touching electrical components as they may hold a dangerous charge of 400VDC, then verify DC Voltage is less than 42 VDC at inverter test points labeled +VDC and -VDC before servicing board.





**Approved Combinations for Variable Speed Units**

- AZONE 850 Comfort Control, or AZONE 950 with Software Version 3.0 or Higher
- TAM8C or later models
- Platinum SV Furnace
- Platinum ZV Furnace
- Approved System Accessories

**Note:** See AHRI directory for approved indoor and outdoor model combinations. Only Trane coils and air handlers are approved for use with variable speed outdoor units.



Scan to see an overview video about the IVSC Board

**Table 1. Operating Range**

Cooling	55° F to 120° F
Heating	-10° F to 66° F

## Table of Contents

Unit Location Considerations.....	5	Electrical — High Voltage .....	18
.....	6	Integrated Variable Speed Control Board	
Coastal Considerations .....	7	LED Indicators .....	19
Unit Preparation .....	8	Start Up .....	20
Setting Up the Unit .....	8	System Charge Adjustment .....	21
Refrigerant Line Considerations .....	9	Subcool Charging Correction Charts.....	22
Refrigerant Line Brazing .....	12	Refrigerant Charging Chart .....	22
Refrigerant Line Leak Check .....	14	Charging the Unit.....	23
Refrigerant Line and Indoor Coil		Communicating Display Assembly	
Evacuation .....	14	(CDA).....	25
Charging: Weigh-In Method .....	15	Defrost Control (Heat Pump only).....	26
Service Valves .....	16	Checkout Procedures .....	27
Electrical — Low Voltage .....	17		

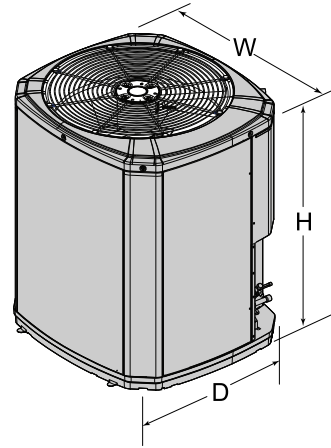
## Unit Location Considerations

**Table 2. Unit Dimensions and Weight**

Models	H x D x W (in)	Weight * (lb)
4A6V8024A	41 x 30 x 33	195
4A6V8036A	41 x 30 x 33	208
4A6V8037A	41 x 34 x 37	229
4A6V8048A	41 x 34 x 37	234
4A6V8049A	41 x 34 x 37	241
4A6V8060A	45 x 34 x 37	250
4A7V8024A	41 x 30 x 33	196
4A7V8036A	41 x 30 x 33	207
4A7V8037A	41 x 34 x 37	225
4A7V8048A	41 x 34 x 37	245
4A7V8060A	45 x 34 x 37	250

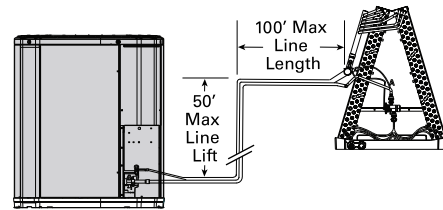
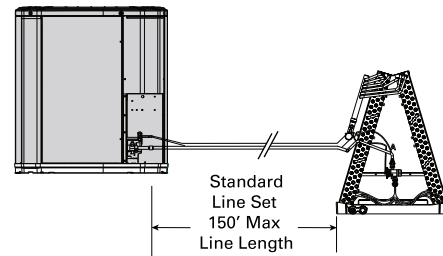
\* Weight values are estimated (uncrated).

- When mounting the outdoor unit on a roof, be sure the roof will support the unit's weight.
- Properly selected isolation is recommended to alleviate sound or vibration transmission to the building structure.

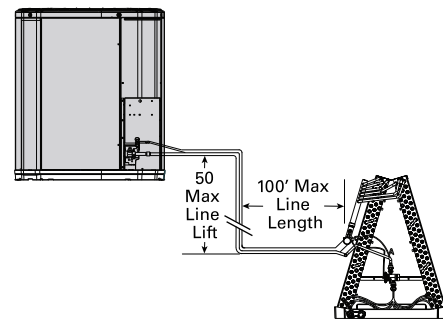


**Table 3. Refrigerant Line and Service Valve Connection Sizes**

Model	Rated Line Sizes		Service Valve Connection Sizes	
	Vapor Line	Liquid Line	Vapor Line Connection	Liquid Line Connection
4A6V8024A	5/8 (a)	3/8	5/8	3/8
4A6V8036A	3/4	3/8	3/4	3/8
4A6V8037A	3/4	3/8	3/4	3/8
4A6V8048A	7/8	3/8	7/8	3/8
4A6V8049A	7/8	3/8	7/8	3/8
4A6V8060A	1-1/8 (b)	3/8	7/8	3/8
4A7V8024A	5/8	3/8	5/8	3/8
4A7V8036A	3/4	3/8	3/4	3/8
4A7V8037A	3/4	3/8	3/4	3/8
4A7V8048A	7/8	3/8	7/8	3/8
4A7V8060A	1-1/8 (c)	3/8	7/8	3/8



Refer to (a), (b), and (c) footnotes for specific model details



(a) The max length of refrigerant lines from outdoor to indoor unit MUST NOT exceed 150 feet. The max vertical change MUST NOT exceed 50 feet.  
 (b) The max length of refrigerant lines from the outdoor to indoor unit MUST NOT exceed 80 feet. The max vertical change MUST NOT exceed 10 feet.  
 (c) The max length of refrigerant lines from outdoor to indoor unit MUST NOT exceed 80 feet. The max vertical change MUST NOT exceed 25 feet.

## Unit Location Considerations

**Table 4. Alternate Refrigerant Line and Service Valve Connection Sizes**

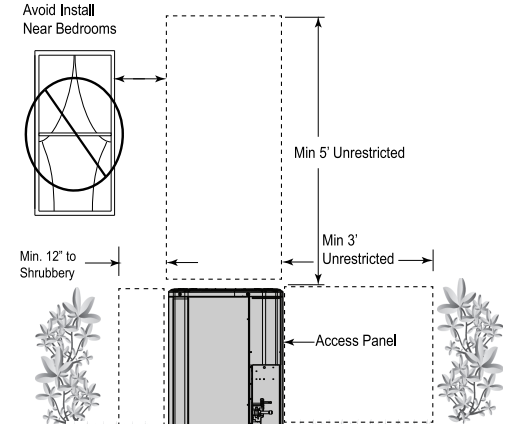
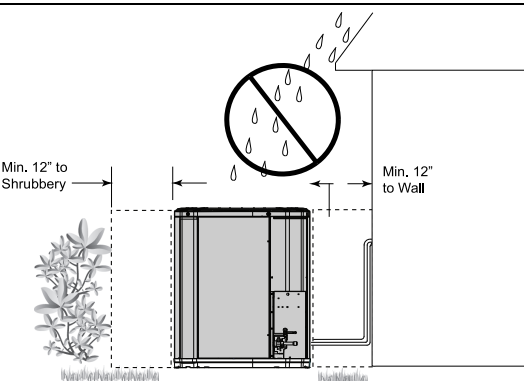
Model	Alternate Line Sizes		Service Valve Connection Sizes	
	Vapor Line	Liquid Line	Vapor Line Connection	Liquid Line Connection
4A6V8024A	3/4" (a)	5/16"	5/8"	3/8"
4A6V8036A	5/8" (a)	5/16"	3/4"	3/8"
	7/8" (b)	5/16"	3/4"	3/8"
4A6V8037A	5/8" (a)	5/16"	3/4"	3/8"
	7/8" (b)	5/16"	3/4"	3/8"
4A6V8048A	3/4" (a)	3/8"	7/8"	3/8"
4A6V8049A	3/4" (a)	3/8"	7/8"	3/8"
4A6V8060A	3/4" (a)	3/8"	7/8"	3/8"
	7/8" (a)	3/8"	7/8"	3/8"
Model	Alternate Line Sizes		Service Valve Connection Sizes	
	Vapor Line	Liquid Line	Vapor Line Connection	Liquid Line Connection
4A7V8024A	3/4" (a)	5/16"	5/8"	3/8"
4A7V8036A	5/8" (a)	5/16"	3/4"	3/8"
	7/8" (b)	5/16"	3/4"	3/8"
4A7V8048A	3/4" (a)	3/8"	7/8"	3/8"
4A7V8060A	3/4" (a)	3/8"	7/8"	3/8"
	7/8" (a)	3/8"	7/8"	3/8"

(a) The max length of refrigerant lines from outdoor to indoor unit MUST NOT exceed 150 feet. The max vertical change MUST NOT exceed 50 feet.

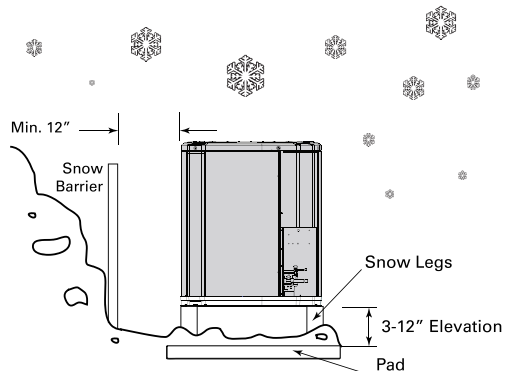
(b) The max length of refrigerant lines from outdoor to indoor unit MUST NOT exceed 80 feet. The max vertical change MUST NOT exceed 25 feet.

## Unit Location Considerations

**Table 5. Suggested Locations for Best Reliability**

<ul style="list-style-type: none"> <li>• Ensure the top discharge area is unrestricted for at least 5 feet above the unit.</li> <li>• Provide at least 3 feet clearance in front of the control box (access panels) and any other side requiring service.</li> <li>• Do not locate close to bedrooms as operational sounds may be objectionable.</li> <li>• Avoid locations near windows and similar areas where condensation and freezing defrost vapor can annoy a customer.</li> <li>• Position the outdoor unit a minimum of 12" from any wall or surrounding shrubbery to ensure adequate airflow.</li> <li>• Outdoor unit location must be far enough away from any structure to prevent excess roof runoff water or icicles from falling directly on the unit.</li> </ul>	
<ul style="list-style-type: none"> <li>• Position the outdoor unit a minimum of 12" from any wall or surrounding shrubbery to ensure adequate airflow.</li> <li>• Outdoor unit location must be far enough away from any structure to prevent excess roof runoff water or icicles from falling directly on the unit.</li> </ul>	

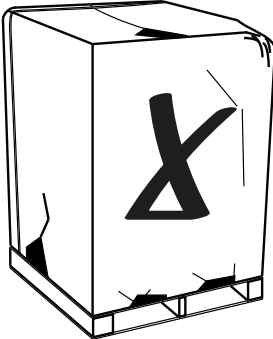
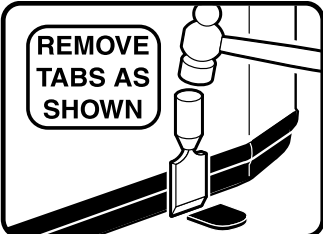
**Table 6. Cold Climate Considerations (Heat Pump Only)**

<p><b>Note:</b> It is recommended that these precautions be taken for units being installed in areas where snow accumulation and prolonged below-freezing temperatures occur.</p> <ul style="list-style-type: none"> <li>• Units should be elevated 3–12 inches above the pad or rooftop, depending on local weather. This additional height will allow drainage of snow and ice melted during defrost cycle prior to its refreezing. Ensure that drain holes in unit base pan are not obstructed, preventing drainage of defrost water.</li> <li>• If possible, avoid locations that are likely to accumulate snow drifts. If not possible, a snow drift barrier should be installed around the unit to prevent a build-up of snow on the sides of the unit.</li> </ul>	
--	--

## Coastal Considerations

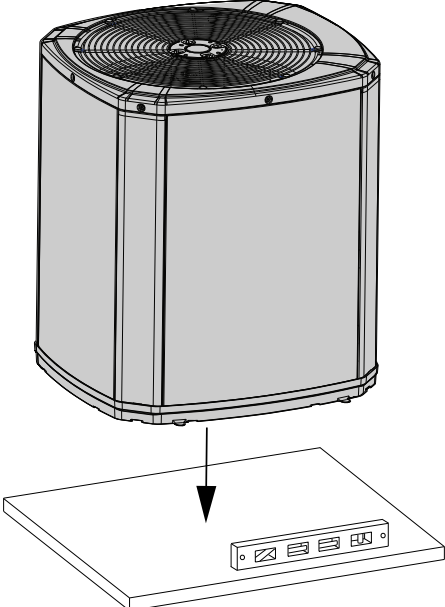
If installed within one mile of salt water, including seacoasts and inland waterways, models without factory supplied Seacoast Salt Shields require the addition of BAYSEAC001 (Seacoast Kit) at installation time.

## Unit Preparation

<p>1. Check for damage and report promptly to the carrier any damage found to the unit.</p>	
<p>2. To remove the unit from the pallet, remove tabs by cutting with a sharp tool.</p>	

## Setting Up the Unit

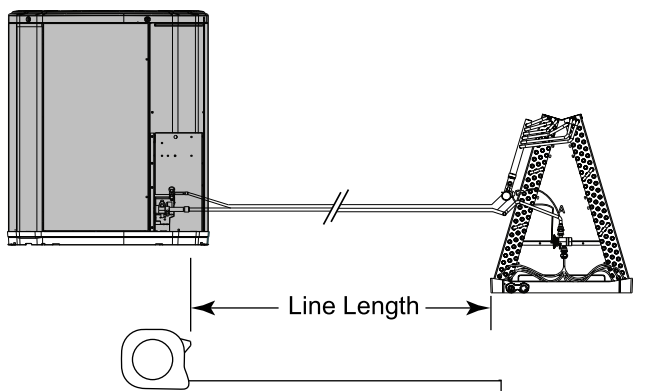
**Table 7. Pad Installation**

<p>When installing the unit on a support pad, such as a concrete slab, consider the following:</p> <ul style="list-style-type: none"><li>• The pad should be at least 1" larger than the unit on all sides.</li><li>• The pad must be separate from any structure.</li><li>• The pad must be level.</li><li>• The pad should be high enough above grade to allow for drainage.</li><li>• The pad location must comply with National, State, and Local codes.</li></ul>	
--	--

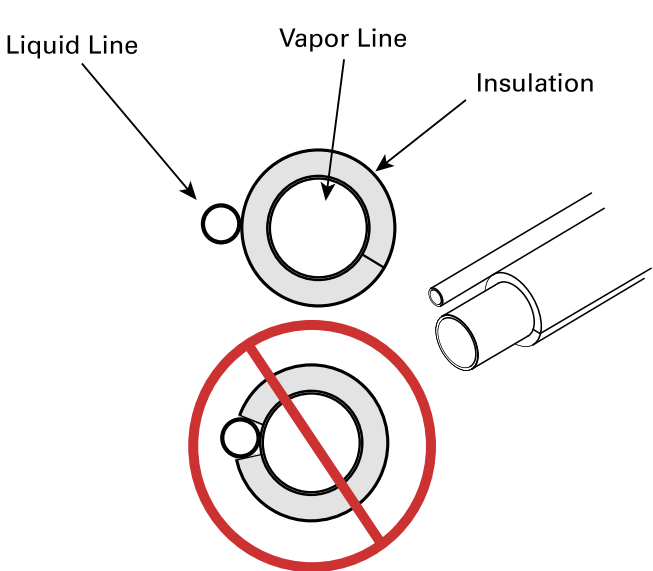


# Refrigerant Line Considerations

**Table 8. Required Refrigerant Line Length**

<p>Determine required line length and lift. You will need this to determine the subcooling charging corrections later in the installation process.</p> <p>Total Line Length = _____ Ft.</p> <p>Total Vertical Change (lift) = _____ Ft.</p>	
---	--

**Table 9. Refrigerant Line Insulation**

<p><b>Important:</b> The Vapor Line must always be insulated. DO NOT allow the Liquid Line and Vapor Line to come in direct (metal to metal) contact.</p> <p><b>Note:</b> The gas line must always be insulated. Insulating the liquid line through attic spaces may benefit system performance by minimizing heat gain in the liquid line.</p>	
---	---

## Refrigerant Line Considerations

**Table 10. Reuse Existing Refrigerant Lines**

<div style="background-color: black; color: white; padding: 5px; text-align: center; font-weight: bold;"> <span style="font-size: 1.2em;">⚠ CAUTION</span> </div> <p style="font-weight: bold; margin-top: 5px;">REFRIGERANT!</p> <p>Failure to inspect or use proper service tools may result in equipment damage or personal injury. If using existing refrigerant lines make certain that all joints are brazed, not soldered.</p> <p>For retrofit applications, where the existing indoor evaporator coil and/or refrigerant lines will be used, the following precautions should be taken.</p> <ul style="list-style-type: none"> <li>• Ensure that the indoor evaporator coil and refrigerant lines are the correct size.</li> <li>• Ensure that the refrigerant lines are free of leaks, acid, and oil.</li> </ul> <p><b>Important:</b> For more information, see publication number SS-APG006-EN</p>	
--	--

**Table 11. Refrigerant Line Routing Precautions**

<p><b>Important:</b> Comply with National, State, and Local Codes when isolating line sets from joists, rafters, walls, or other structural elements.</p> <p><b>Important:</b> Take precautions to prevent noise within the building structure due to vibration transmission from the refrigerant lines.</p> <p>For Example:</p> <ul style="list-style-type: none"> <li>• When the refrigerant lines must be fastened to floor joists or other framing in a structure, use isolation type hangers.</li> <li>• Isolation hangers should also be used when refrigerant lines are run in stud spaces or enclosed ceilings.</li> <li>• Where the refrigerant lines run through a wall or sill, they should be insulated and isolated.</li> <li>• Isolate the lines from all duct work.</li> <li>• Minimize the number of 90° turns.</li> </ul>
--

**Table 12. Isolation From Joist/Rafter**

<p>Secure Vapor Line from joists using isolators every 8 ft. Secure Liquid Line directly to insulated Vapor Line using tape, wire, or other appropriate method every 8 ft.</p>

Refrigerant Line Considerations

Table 13. Isolation In Wall Spaces

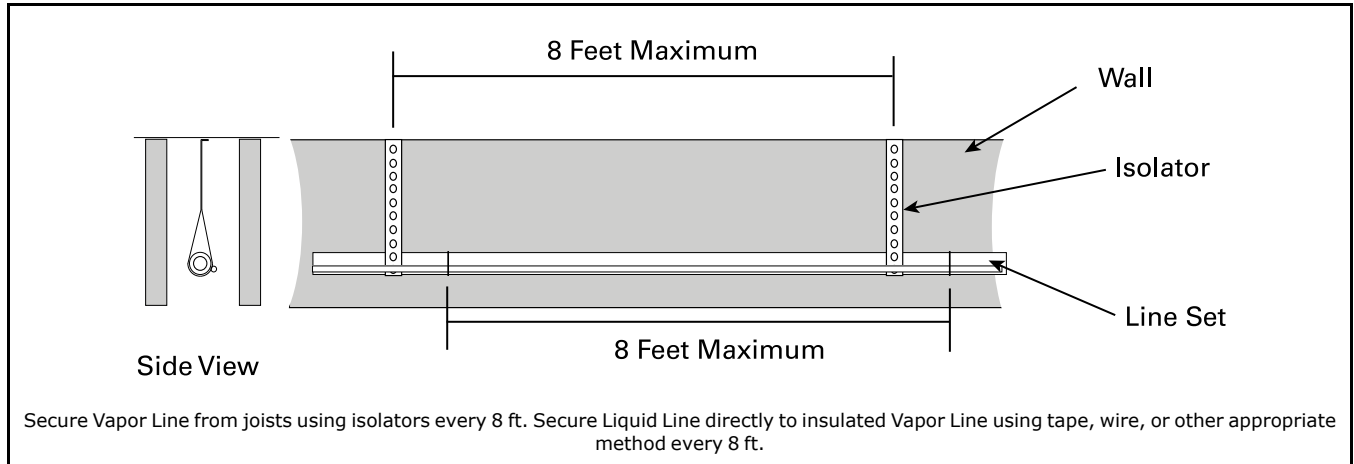
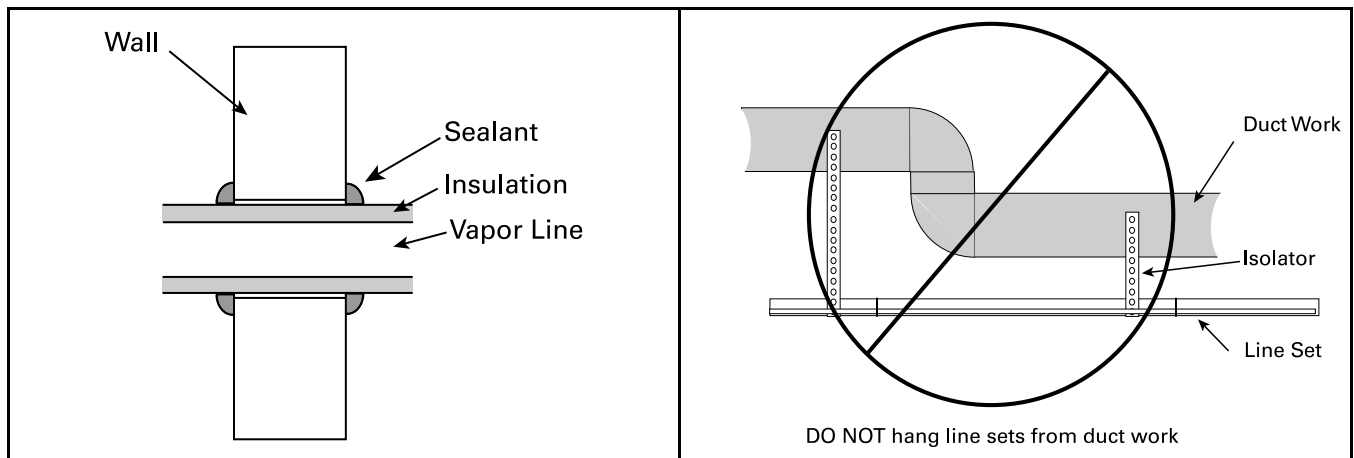
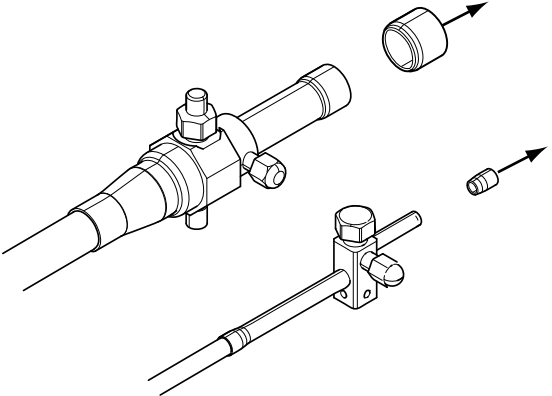
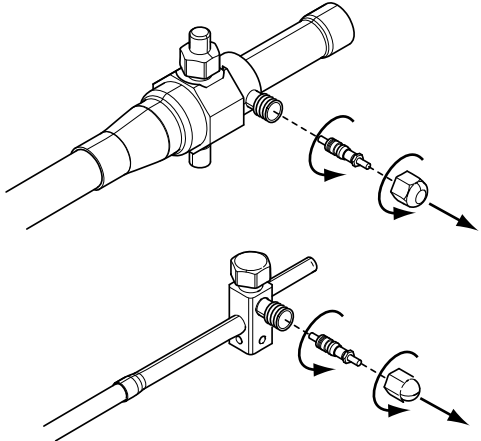
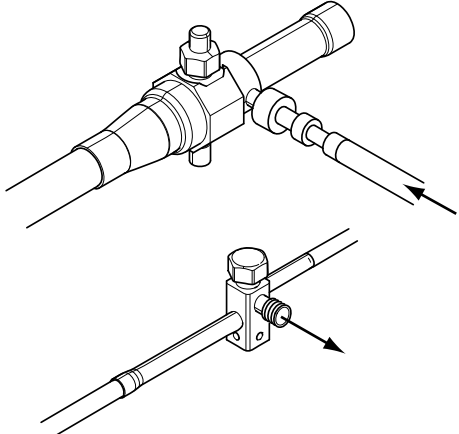


Table 14. Isolation Through Wall



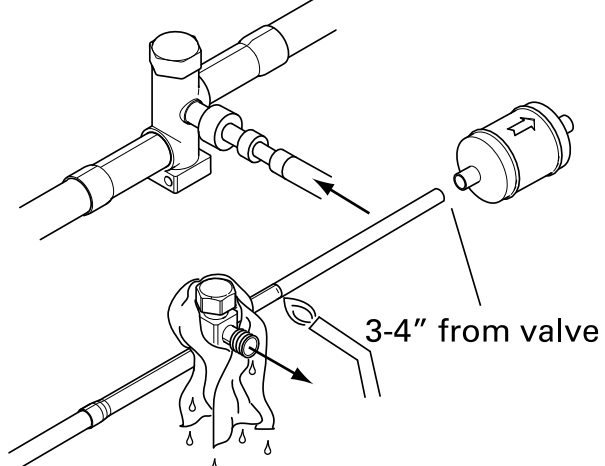
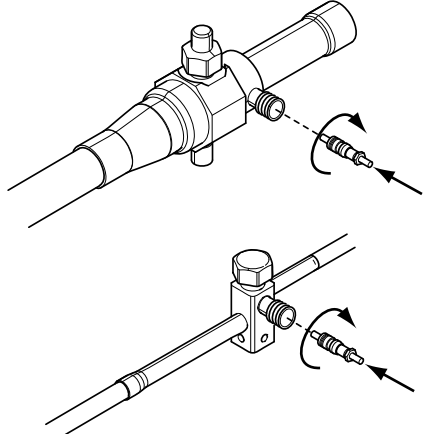
## Refrigerant Line Brazing

**Table 15. Braze the Refrigerant Lines**

<p>1. Remove caps or plugs. Use a deburring tool to debur the pipe ends. Clean both internal and external surfaces of the tubing using an emery cloth.</p>	 <p>The diagram illustrates the first step of the brazing process. It shows two refrigerant lines with service valves. Arrows indicate the removal of caps from the top and side ports of the valves. Below, the pipe ends are shown being cleaned with an emery cloth.</p>
<p>2. Remove the pressure tap cap and valve core from each service valves.</p>	 <p>The diagram illustrates the second step. It shows the same two refrigerant lines. Arrows indicate the removal of the pressure tap caps and valve cores from the service valves. Below, the lines are shown with the caps and cores removed.</p>
<p>3. Purge the refrigerant lines and indoor coil with dry nitrogen.</p>	 <p>The diagram illustrates the third step. It shows the two refrigerant lines with arrows indicating the flow of dry nitrogen through them to purge the lines and indoor coil.</p>

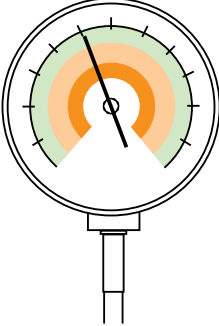
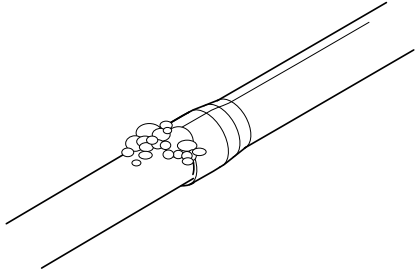
## Refrigerant Line Brazing

**Table 15. Braze the Refrigerant Lines (continued)**

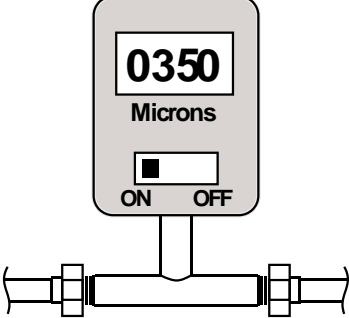

<p>4. Wrap a wet rag around the valve body to avoid heat damage and continue the dry nitrogen purge.</p> <p>5. Braze the refrigerant lines to the service valves.</p> <p>a. For Units shipped with a field-installed external drier, check liquid line filter drier's directional flow arrow to confirm correct direction of refrigeration flow (away from outdoor unit and toward evaporator coil) as illustrated. Braze the filter drier to the Liquid Line.</p> <p>6. Continue the dry nitrogen purge. Do not remove the wet rag until all brazing is completed.</p> <p><b>Important:</b> Remove the wet rag before stopping the dry nitrogen purge.</p> <p><b>Note:</b> Precautions should be taken to avoid heat damage to base pan during brazing. It is recommended to keep the flame directly off of the base pan.</p>	
<p>7. Replace the pressure tap valve cores after the service valves have cooled.</p>	

# Refrigerant Line Leak Check

**Table 16. Check for Leaks**

<p>1. Pressurize the refrigerant lines and evaporator coil to 150 PSIG using dry nitrogen.</p>	<p style="text-align: center;"><b>150 PSIG</b></p> 
<p>2. Check for leaks by using a soapy solution at each brazed location. <b>Note:</b> Remove nitrogen pressure and repair any leaks before continuing.</p>	

## Refrigerant Line and Indoor Coil Evacuation

<p><b>Important:</b> Do not open the service valves until the refrigerant lines and indoor coil leak check and evacuation are complete.</p> <p>1. Evacuate until the micron gauge reads no higher than 350 microns, then close off the valve to the vacuum pump.</p>	
<p>2. Observe the micron gauge. Evacuation is complete if the micron gauge does not rise above 500 microns in one (1) minute.</p> <p>3. When evacuation is complete, blank off the vacuum pump and micron gauge, and close the valves on the manifold gauge set.</p>	

## Charging: Weigh-In Method

Weigh-In Method can be used for the initial installation, or anytime a system charge is being replaced. Weigh-In Method can also be used when power is not available to the equipment site or operating conditions (indoor/outdoor temperatures) are not in range to verify with the subcooling charging method.

**Table 17. Heat Pumps**

A	B		C	D
Model	Factory Charge		Charge adder for Indoor Coil	Charge multiplier for interconnecting refrigerant tube length
024	7 lb.	6 oz.	6 oz.	0.6 oz/ft
036	8 lb.	3 oz.	8 oz.	0.6 oz/ft
037	9 lb.	8 oz.	12 oz.	0.6 oz/ft
048	9 lb.	13 oz.	13 oz.	0.6 oz/ft
049	10 lb.	12 oz.	15 oz.	0.6 oz/ft
060	11 lb.	14 oz.	1 lb., 2 oz.	0.6 oz/ft

**Table 18. Air Conditioners**

A	B		C	D
Model	Factory Charge		Charge adder for Indoor Coil	Charge multiplier for interconnecting refrigerant tube length
024	7 lb.	6 oz.	6 oz.	0.6 oz/ft
036	7 lb.	14 oz.	7 oz.	0.6 oz/ft
037	9 lb.	6 oz.	12 oz.	0.6 oz/ft
048	11 lb.	1 oz.	1 lb., 0 oz.	0.6 oz/ft
060	11 lb.	14 oz.	1 lb., 2 oz.	0.6 oz/ft

**Table 19. New Installations – Calculating Charge using the Weigh-In method**

<ol style="list-style-type: none"> <li>1. Measure in feet the distance between the outdoor unit and the indoor unit and record on Line 1. Include the entire length of the line from the service valve to the IDU.</li> <li>2. Enter the charge multiplier from Column D.</li> <li>3. Multiply the total length of refrigerant tubing (Line 1) times the value on Step 2. Record the result on Line 3 of the Worksheet.</li> <li>4. Locate the outdoor equipment size in Column A. Record the value shown in Column C of Table 16 for Heat Pumps or Table 17 for Air Conditioners.</li> <li>5. Add the values from Step 3 and Step 4 and record the resulting value. This is the amount of refrigerant to weigh-in prior to opening the service valves.</li> </ol>	<p><b>New Installation Weigh-In Method Worksheet</b></p> <ol style="list-style-type: none"> <li>1. Line Length (ft) _____</li> <li>2. Value from Column D     x _____</li> <li>3. Step 1 x Step 2             = _____</li> <li>4. Charge Adder (column C) + _____</li> <li>5. Refrigerant (Steps 3+4)   = _____</li> </ol>
--	--

**Table 20. Sealed-System Repairs – Calculating Charge using the Weigh-In method.**

<ol style="list-style-type: none"> <li>1. Measure in feet the distance between the outdoor unit and the indoor unit and record on Line 1. Include the entire length of the line from the service valve to the IDU.</li> <li>2. Enter the charge multiplier from Column D.</li> <li>3. Multiply the total length of refrigerant tubing (Line 1) times the value on Line 2. Record the result on Line 3 of the Worksheet.</li> <li>4. Locate the outdoor equipment size in Column A. Record the value shown in Column C of Table 16 for Heat Pumps or Table 17 for Air Conditioners.</li> <li>5. Record the value in Column B to Line 5 of the Worksheet.</li> <li>6. Add the values from Step 3, Step 4, and Step 5 and record the resulting value on Line 6. This is the amount of refrigerant to weigh-in.</li> </ol>	<p><b>New Installation Weigh-In Method Worksheet</b></p> <ol style="list-style-type: none"> <li>1. Line Length (ft) _____</li> <li>2. Value from Column D     x _____</li> <li>3. Step 1 x Step 2             = _____</li> <li>4. Charge Adder (column C) + _____</li> <li>5. Factory Charge (column B) + _____</li> <li>6. Refrigerant (Steps 3+4+5) = _____</li> </ol>
--	--

**Note:** The only mode approved for setting or validating system charge is using Charging Mode-Cooling. Charging Mode-Cooling is a variable speed test mode found in the 850/950 comfort control Technician Menu. Outdoor Temperature must be between 55°F and 120°F with Indoor Temperature kept between 70°F and 80°F.

# Service Valves

**Table 21. Open the Gas Service Valve**

<p><b>Important:</b> Leak check and evacuation must be completed before opening the service valves.</p> <p><b>Note:</b> Do not vent refrigerant gases into the atmosphere.</p> <ol style="list-style-type: none"> <li>1. Remove valve stem cap.</li> <li>2. Using a wrench, turn valve stem 1/4 turn counterclockwise to the fully open position.</li> <li>3. Replace the valve stem cap to prevent leaks. Tighten finger tight plus an additional 1/6 turn.</li> </ol>	<p>The diagram shows a gas service valve with a cap being removed from the valve stem. A curved arrow indicates a 1/4 turn counterclockwise rotation. Labels include: Cap, 1/4 Turn Only Counterclockwise for Full Open Position, Valve Stem, Unit Side of Valve, Pressure Tap Port, and Gas Line Connection.</p>
---	---

**Table 22. Open the Liquid Service Valve**

<div style="background-color: black; color: white; padding: 5px; text-align: center;"> <p><b>⚠ WARNING</b></p> </div> <p><b>SERVICE VALVES!</b></p> <p>Failure to follow this warning will result in abrupt release of system charge and may result in personal injury and/or property damage. Extreme caution should be exercised when opening the Liquid Line Service Valve. Turn valve stem counterclockwise only until the stem contacts the rolled edge. No torque is required.</p> <p><b>Important:</b> Leak check and evacuation must be completed before opening the service valves.</p> <ol style="list-style-type: none"> <li>4. Remove service valve cap.</li> <li>5. Fully insert 3/16" hex wrench into the stem and back out counterclockwise until valve stem just touches the rolled edge (approximately five (5) turns).</li> <li>6. Replace the valve cap to prevent leaks. Tighten finger tight plus an additional 1/6 turn.</li> </ol>	<p>The diagram shows a liquid service valve with a cap being removed. A 3/16" hex wrench is inserted into the stem, and a curved arrow indicates a counterclockwise rotation until it contacts a rolled edge. Labels include: Cap, 3/16" Hex Wrench, Rolled Edge to Captivate Stem, Hex Headed Valve System, Service Port, and Unit Side of Service Valve.</p>
---	--



# Electrical – Low Voltage

Table 23, p. 17 defines the size and combined total maximum length of low voltage wiring from the outdoor unit, to the indoor unit, and to the thermostat.

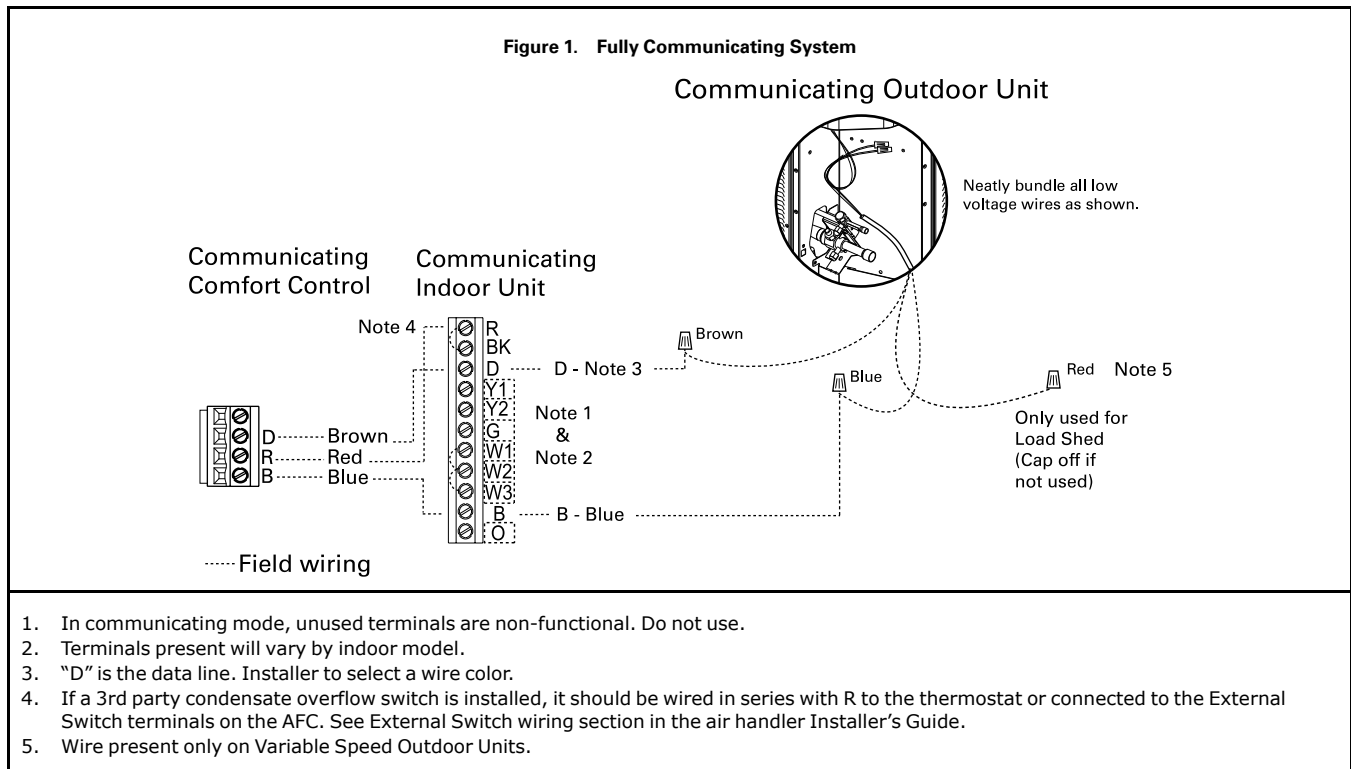
**Note:** The use of color coded low voltage wire is recommended to simplify connections between the outdoor unit, the control, and the indoor unit.

**Note:** The maximum total cable length for the entire comfort control communicating system is 500 ft. 18 AWG.

**Table 23. Low Voltage Maximum Wire Length**

CONTROL WIRING	
WIRE SIZE	MAX. WIRE LENGTH
18 AWG	500 Ft. Combined

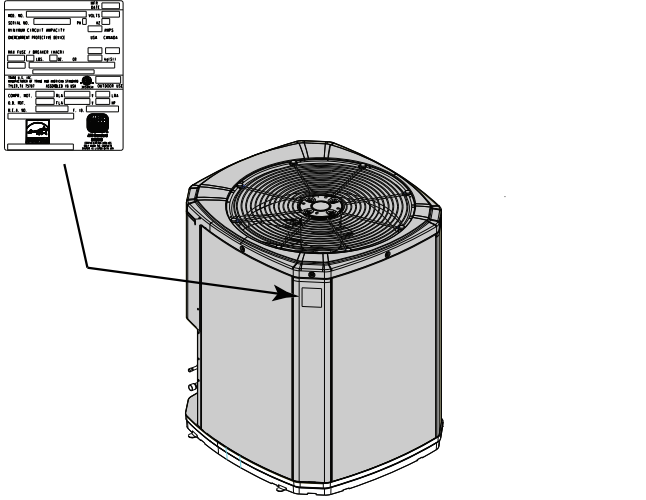
**Table 24. Low Voltage Hook-up Diagrams**



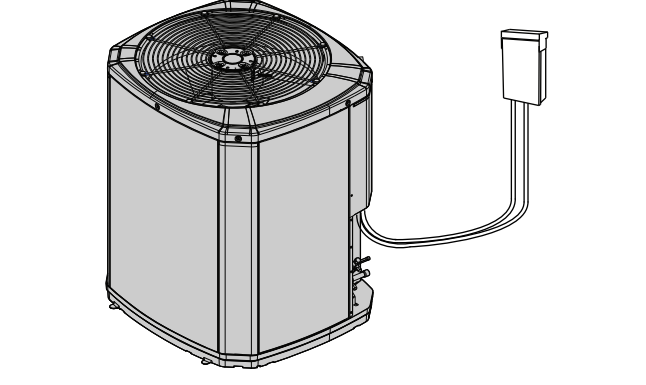
**Note:** Anti-oxidizing grease is supplied in the documentation package for use when making low voltage field wiring connections at the outdoor unit. Apply grease to field wiring before installing wire caps to protect these connections from corrosion.

# Electrical — High Voltage

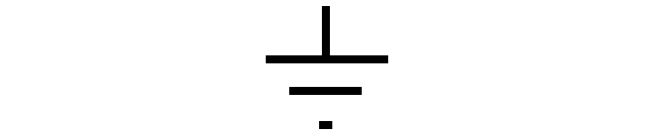
**Table 25. High Voltage Power Supply**

<p><b>⚠ WARNING</b> <b>LIVE ELECTRICAL COMPONENTS!</b> Failure to follow this Warning could result in property damage, severe personal injury, or death. Follow all electrical safety precautions when exposed to live electrical components. It may be necessary to work with live electrical components during installation, testing, servicing, and troubleshooting of this product.</p>	 <p>The diagram shows a high voltage power supply unit with a fan on top. An inset shows a wiring diagram with various electrical symbols and labels. An arrow points from the inset to the unit's control panel area.</p>
<p>The high voltage power supply must agree with the equipment nameplate.</p> <p>Power wiring must comply with national, state, and local codes.</p> <p>Follow instructions on unit wiring diagram located on the inside of the control box cover and in the Service Facts document included with the unit.</p>	

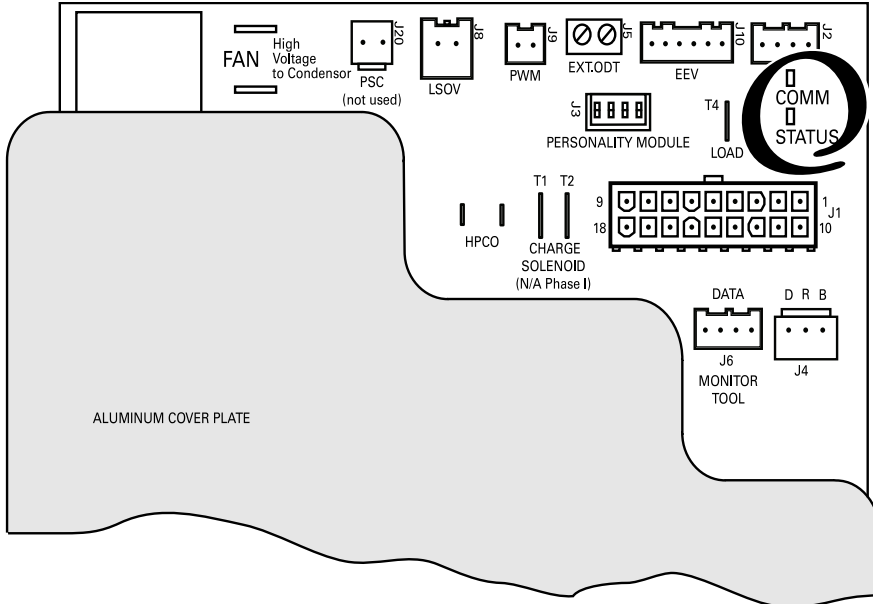
**Table 26. High Voltage Disconnect Switch**

<p><b>⚠ WARNING</b> <b>HIGH LEAKAGE CURRENT!</b> Failure to follow this Warning could result in property damage, severe personal injury, or death. Earth connection essential before connecting electrical supply.</p>	 <p>The diagram shows a high voltage disconnect switch connected to a unit. The switch is a rectangular box with a handle, connected to the unit by a cable.</p>
<p>Install a separate disconnect switch at the outdoor unit.</p> <p>For high voltage connections, flexible electrical conduit is recommended whenever vibration transmission may create a noise problem within the structure.</p>	

**Table 27. High Voltage Disconnect Switch**

<p>Ground the outdoor unit per national, state, and local code requirements.</p>	 <p>The diagram shows a standard electrical grounding symbol, consisting of a vertical line connected to three horizontal lines of decreasing width, with a small dot below the bottom line.</p>
--	--

# Integrated Variable Speed Control Board LED Indicators



The Status (Green) and COMM (Amber) LEDs are located in the upper right region of the Control Board.

Fault messages are displayed on the CDA

## LED'S

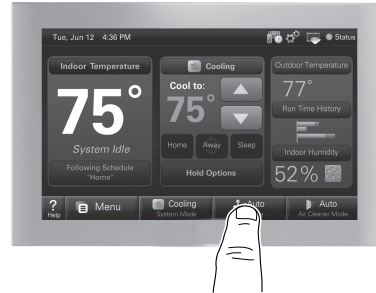
LED	RATE	DESCRIP-TION	INDICA-TION
STATUS (GREEN)	SLOW	1 TIME PER SECOND	STANDBY/ IDLE
	MEDIUM	2 TIMES PER SECOND	CALL FOR CAPACITY
	FAST	5 TIMES PER SECOND	POWER UP DELAY
	SOLID ON		TEST MODE
	INTERMITTENT	1 FLASH EVERY 4 SECONDS	HARD LOCKOUT

LED	RATE	DESCRIPTION	INDICATION
COMM (AMBER)	SLOW	1 TIME PER DEVICE	DEVICE COUNT
	FAST	5 TIME PER SECOND	LOSS OF COMMUNICATION

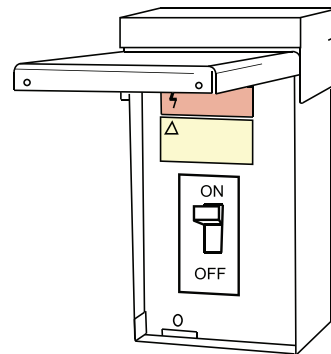
# Start Up

1. Ensure you have completed the following sections. "Refrigerant Line Brazing," p. 12 through "Electrical – High Voltage," p. 18

2. Set System Thermostat to OFF.



3. Turn on disconnect(s) to apply power to the indoor and outdoor units.



4. Wait 3 hours before starting the unit if the outdoor ambient temperature is below 85° F



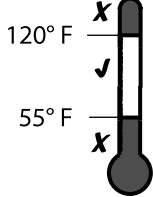
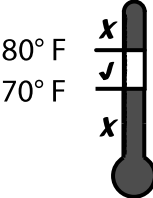
5. Run the system using the "Charging Mode-Cooling" test mode found in the 850/950 comfort control. This is the only approved method for setting the system charge level by subcooling.

Follow the on-screen prompts.



# System Charge Adjustment

**Table 28. Temperature Measurements**

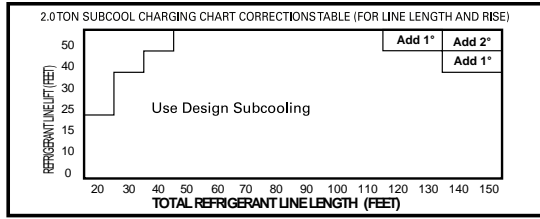
<p>Check the outdoor temperatures.</p> <p>Subcooling using <b>"Charging Mode-Cooling"</b> is the only recommended method of charging between 55 ° F and 120° F ambient outdoor temperature.</p>	
<p>For best results the indoor temperature should be kept between 70° F to 80° F.</p>	

**Table 29. Subcooling Charging Corrections**

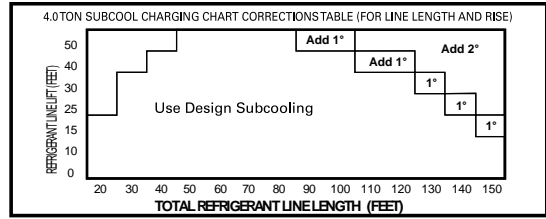
<p>Determine the final subcooling value using total Line Length and Lift measured in <a href="#">Table 8, p. 9</a>— (Required Refrigerant Line Length) and the Subcooling Charging Corrections Charts.</p>	<p><b>Subcooling Charging Correction Worksheet</b></p> <p>Total Line Length (ft) _____</p> <p>Total Vertical Charge (lift) _____ <i>(Values from — Required Refrigerant Line Length)</i></p> <p>Design Subcooling Value _____ <i>(from nameplate or Service Facts)</i></p> <p><b>Final Subcooling Value</b> _____</p>
--	---

# Subcool Charging Correction Charts

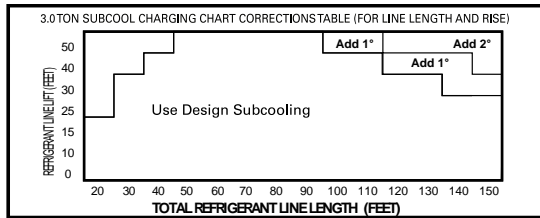
**Figure 2. Subcool Charging Corrections — 2.0 Ton**



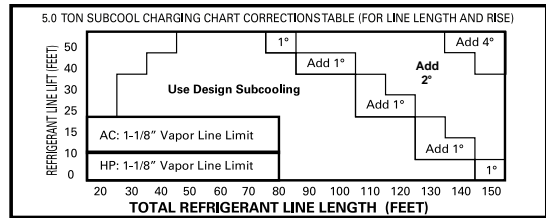
**Figure 4. Subcool Charging Corrections — 4.0 Ton**



**Figure 3. Subcool Charging Corrections — 3.0 Ton**



**Figure 5. Subcool Charging Corrections — 5.0 Ton**



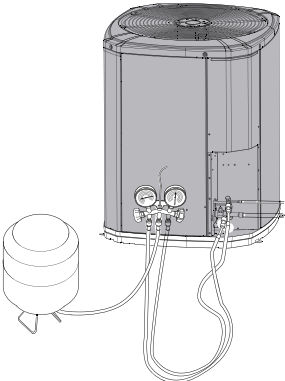
NOTE: 150 ft. length is approved ONLY with 7/8" vapor lines.

## Refrigerant Charging Chart


R-410A REFRIGERANT CHARGING CHART							
LIQUID TEMP (°F)	DESIGN SUBCOOLING (°F)						
	8	9	10	11	12	13	14
	LIQUID GAGE PRESSURE (PSI)						
55	179	182	185	188	191	195	198
60	195	198	201	204	208	211	215
65	211	215	218	222	225	229	232
70	229	232	236	240	243	247	251
75	247	251	255	259	263	267	271
80	267	271	275	279	283	287	291
85	287	291	296	300	304	309	313
90	309	313	318	322	327	331	336
95	331	336	341	346	351	355	360
100	355	360	365	370	376	381	386
105	381	386	391	396	402	407	413
110	407	413	418	424	429	435	441
115	435	441	446	452	458	464	470
120	464	470	476	482	488	495	501
125	495	501	507	514	520	527	533
Refer to Service Facts or Installer's Guide for charging method							

# Charging the Unit

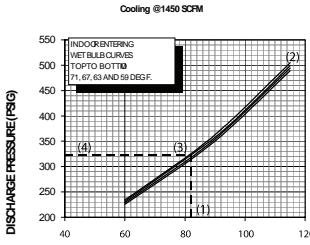
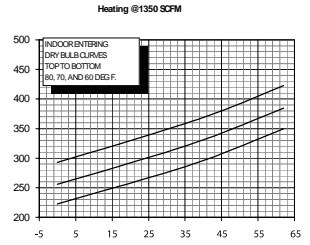
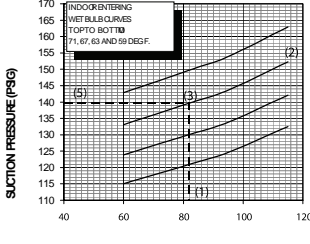
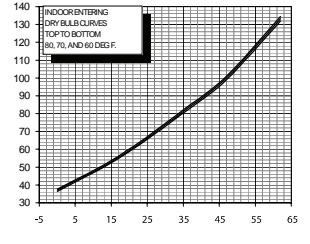
**Table 30. Proper Gage Pressure**

<p>Using the "Refrigerant Charging Chart", p. 22 adjust refrigerant level to attain proper gage pressure.</p> <p>Add refrigerant if the Liquid Gage Pressure is lower than the chart value.</p> <ol style="list-style-type: none"> <li>1. Connect gauges to refrigerant bottle and unit as illustrated.</li> <li>2. Purge all hoses.</li> <li>3. Open bottle.</li> <li>4. Stop adding refrigerant when liquid line temperature and Liquid Gage Pressure match the charging chart.</li> </ol> <p><b>Note:</b> Recover refrigerant if the Liquid Gage Pressure is higher than the chart value.</p>	
--	---

**Table 31. Stabilize the system**

<ol style="list-style-type: none"> <li>5. Wait 20 minutes for the system condition to stabilize between adjustments.</li> </ol> <p><b>Note:</b> When the Liquid Line Temperature and Gage Pressure approximately match the chart, the system is properly charged.</p> <ol style="list-style-type: none"> <li>6. Remove gauges.</li> <li>7. Replace service port caps to prevent leaks. Tighten finger tight plus an additional 1/6 turn.</li> </ol>	
---	--

**Table 32. Verify Performance**

<ol style="list-style-type: none"> <li>8. Refer to System Pressure Curves in the Service Facts document to verify typical performance.</li> </ol>	<p><b>PRESSURE CURVE SAMPLE</b></p> <div style="display: flex; flex-wrap: wrap; justify-content: space-around;"> <div style="width: 48%;"> <p>Cooling @1450 SCFM</p>  </div> <div style="width: 48%;"> <p>Heating @1350 SCFM</p>  </div> </div> <div style="display: flex; flex-wrap: wrap; justify-content: space-around; margin-top: 10px;"> <div style="width: 48%;"> <p>INDOOR ENTERING WET BULB CURVES (1) TO (5) 71, 67, 63 AND 59 DEG.F</p>  </div> <div style="width: 48%;"> <p>INDOOR ENTERING DRY BULB CURVES (1) TO (5) 80, 70, AND 60 DEG.F</p>  </div> </div>
---	--

## Charging the Unit

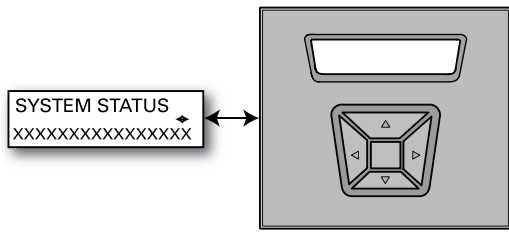
---

**Table 33. System Information**

<p>9. Record system pressures and temperatures after charging is complete.</p> <p>Outdoor model number = _____</p> <p>Measured Outdoor Ambient = _____ °F</p> <p>Measured Indoor Ambient = _____ °F</p> <p>Measured Liquid Line Temp = _____ °F</p> <p>Measured Suction Line Temp = _____ °F</p>	<p>Indoor Wet Bulb = _____ °F</p> <p>Liquid Gage Pressure = _____ PSIG</p> <p>Suction Gage Pressure = _____ PSIG</p>
--	--



# Communicating Display Assembly (CDA)



## NAVIGATION

- To enter and exit Technician Menus, press the Up/Down buttons simultaneously for 5 seconds.
- To return to the Home Screen, press the Up/Down buttons simultaneously for 5 seconds.
- To return to the top level of any menu, press the Left/Right buttons simultaneously for 5 seconds.
- After five minutes of inactivity in the Technician Menu section, the Home Screen will be displayed. Pressing the Enter button for 5 seconds will increase this time to 20 minutes.

## TECHNICIAN MENUS



The Monitor Menu displays information on System status, Drive stats and the System Tachometer.

The Alert Menu displays active alerts.

The Alert History menu displays alerts stored over time. Note that clearing Alert History will also clear Active Alerts.

The Configuration Menu is where System parameters and options are set and reported.

The Control Menu contains a selection of unit function tests that are used to verify operation.

1. External shut down (Load Shed)
2. Min. Airflow
3. Blower on/off delays
4. Custom Airflow
5. PFC (Power Factor Correction)

1. FRC DFT (Forced Defrost)
2. EEV Test
3. Evacuation
4. Drive Diagnostic Test
5. OD Fan Test



Scan to see an overview video about the CDA

**Note:** See the Service Facts found in the control box of the outdoor unit for more information.

# Defrost Control (Heat Pump only)

## Demand Defrost

The demand defrost control measures heat pump outdoor ambient temperature with a sensor located outside the outdoor coil. A second sensor located on the outdoor coil is used to measure the coil temperature. The difference between the ambient and the colder coil temperature is the difference or delta-T measurement. This delta-T measurement is representative of the operating state and relative capacity of the heat pump system. By measuring the change in delta-T, we can determine the need for defrost. The coil sensor also serves to sense outdoor coil temperature for termination of the defrost cycle.

## Fault Identification

A fault condition is indicated by the CDA connected to the control board inside the heat pump control box.

## Defrost Enabled

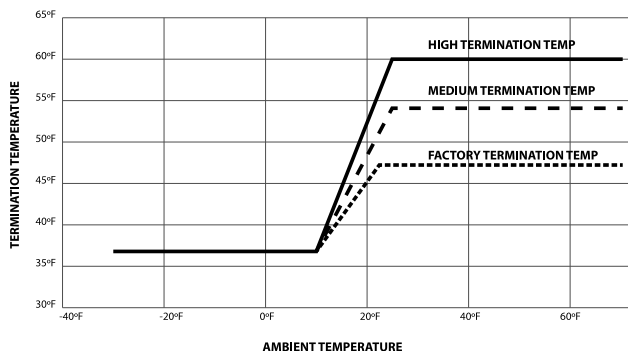
Demand Defrost is enabled with the following inputs to the Integrated Variable Speed Control (IVSC):

- Outdoor ambient temperature sensor (ODS-B) reporting an outdoor temperature at or below 52° F.
- Coil temperature sensor (CBS) reporting a coil temperature at or below 35° F.
- Heat/Cool Demand (HCD) from the communicating comfort control for at least two minutes or more.

## Defrost Initiation

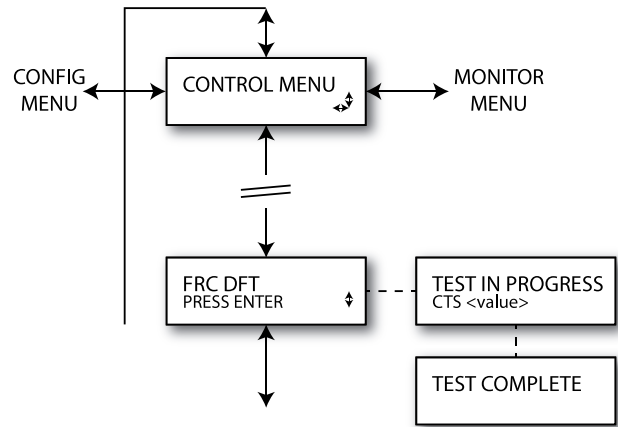
The calculated temperature difference between the outdoor temperature sensor and the coil temperature sensor is called Delta T. Defrost can occur once the current Delta T exceeds the Delta T initiate value. The Defrost initiate value is calculated using a clean-coil Delta T x 2.0, plus a temperature bin correction factor. Initiation Delta T will automatically adjust based on the outdoor temperature. This adaptive logic assures a complete defrost for a range of outdoor temperatures.

**DEFROST TERMINATION PROFILES**



## CDA Navigation to Forced Defrost

**Figure 6. CDA Mini Menu**



## NOTES: Forced Defrost

1. System must be running with demand from the thermostat.
2. FRC DFT TEST can be initiated in heat mode only.
3. Press ENTER to begin forced defrost.
4. Execute Forced Defrost following Forced Defrost (Defrost terminates on Coil Temperature or maximum time override of 15 minutes).
5. When test begins, TEST IN PROGRESS displays on line 1 and Coil Temperature value on line 2.

**Note:** Home Screen, under System Status will display DEFROST.

6. When test is complete, TEST COMPLETE displays for 10 seconds.
7. If there is a defrost fault condition, test terminates and sends alert to the alert menu.
8. For more information, refer to the Alert Code Tables in Service Facts and Technical Service Manual (Pub. No. 34-4301-01) documents.

**Note:** Screens will update as the test proceeds.

## Checkout Procedures

The final phase of the installation is the system Checkout Procedures. The following list represents the most common items covered in a Checkout Procedure. Confirm all requirements in this document have been met.

<ul style="list-style-type: none"><li><input type="checkbox"/> All wiring connections are tight and properly secured.</li><li><input type="checkbox"/> Voltage and running current are within limits.</li><li><input type="checkbox"/> All refrigerant lines (internal and external to equipment) are isolated, secure, and not in direct contact with each other or structure.</li><li><input type="checkbox"/> All braze connections have been checked for leaks. A vacuum of 350 microns provides confirmation that the refrigeration system is leak free and dry.</li><li><input type="checkbox"/> Final unit inspection to confirm factory tubing has not shifted during shipment. Adjust tubing if necessary so tubes do not rub against each other or any component when unit runs.</li><li><input type="checkbox"/> Ductwork is sealed and insulated.</li><li><input type="checkbox"/> All drain lines are clear with joints properly sealed. Pour water into drain pan to confirm proper drainage.</li></ul>	<ul style="list-style-type: none"><li><input type="checkbox"/> Supply registers and return grilles are open, unobstructed, and air filter is installed.</li><li><input type="checkbox"/> Indoor blower and outdoor fan are operating smoothly and without obstruction.</li><li><input type="checkbox"/> Indoor blower motor set on correct speed setting to deliver required CFM.</li><li><input type="checkbox"/> Cover panels are in place and properly tightened.</li><li><input type="checkbox"/> For gas heating systems, manifold pressure has been checked and all gas line connections are tight and leak free.</li><li><input type="checkbox"/> For gas heating systems, flue gas is properly vented.</li><li><input type="checkbox"/> System functions safely and properly in all modes.</li><li><input type="checkbox"/> Owner has been instructed on use of system and given manual.</li></ul>
---	--

*American Standard*<sup>®</sup>

HEATING & AIR CONDITIONING

American Standard optimizes the performance of homes and buildings around the world. A business of Ingersoll Rand, the leader in creating and sustaining safe, comfortable and energy efficient environments, American Standard offers a broad portfolio of advanced controls and HVAC systems, comprehensive building services, and parts. For more information, visit [www.americanstandardair.com](http://www.americanstandardair.com).

American Standard has a policy of continuous product and product data improvements and reserves the right to change design and specifications without notice.

©2014 American Standard Heating & Air Conditioning

11-BC37D1-1D-EN 13 Oct 2014

Supersedes 11-BC37D1-1C-EN (January 2014)

