



Internal Use Only

<http://biz.lgservice.com>

Multi Air Conditioner SVC MANUAL(General)

MODEL : Multi-Inverter Type

CAUTION

Before Servicing the unit, read the safety precautions in General SVC manual.
Only for authorized service personnel.

TABLE OF CONTENTS

Part 1 General Information	2
1. Safety Precautions.....	3
2. Model Line Up.....	6
3. Nomenclature	9
Part 2 Functions & Controls	11
1. List of Functions & Accessory	12
2. Air Flow	14
3. Air Purifying.....	16
4. Installation Functions	17
5. Reliability	18
6. Convenience Functions & Controls	19
7. Special Function & KIT	26
Part 3 Basic Control	29
1. Normal operation	30
2 Compressor control	30
3. EEV(Electronic Expansion Valve) control	30
4. Oil return control	31
5. Defrost control	31
6. Protection control	32
Part 4 Test Run	33
1. Check before Test Run	34
2. Test Run Flow chart	35
3. Test Runing.....	36
Part 5 Trouble Shooting Guide	38
1. Self-diagnosis Function	39
2. Pump Down	41
3. Evacuation	42
4. Gas Charging	43
5. Cycle Part	44
6. Electronic Parts.....	45
Part 6 Service Order	110
1. PCB Service Order	111

Part 1 General Information

1. Safety Precautions	3
2. Model Line Up	6
3. Nomenclature.....	9

1. Safety Precautions



To prevent injury to the user or other people and property damage, the following instructions must be followed.

- Incorrect operation due to ignoring instruction will cause harm or damage. The seriousness is classified by the following indications.







⚠ WARNING This symbol indicates the possibility of death or serious injury.





⚠ CAUTION This symbol indicates the possibility of injury or damage to properties only.

- Meanings of symbols used in this manual are as shown below.







	Be sure not to do.
	Be sure to follow the instruction.
	Dangerous Voltage

1.1 Cautions in Repair





⚠ WARNING	
Be sure to disconnect the power cable plug from the plug socket before disassembling the equipment for a repair. Internal components and circuit boards are at main potential when the equipment is connected to the power cables. This voltage is extremely dangerous and may cause death or severe injury if come in contact with it.	
Do not touch the discharging refrigerant gas during the repair work. The discharging refrigerant gas. The refrigerant gas can cause frostbite.	
Release the refrigerant gas completely at a well-ventilated place first. Otherwise, when the pipe is disconnected, refrigerant gas or refrigerating machine oil discharges and it Can cause injury.	
When the refrigerant gas leaks during work, execute ventilation. If the refrigerant gas touches to a fire, poisonous gas generates. A case of leakage of the refrigerant and the closed room full with gas is dangerous because a shortage of oxygen occurs. Be sure to execute ventilation.	
When removing the front panel or cabinet, execute short-circuit and discharge between high voltage capacitor terminals. If discharge is not executed, an electric shock is caused by high voltage resulted in a death or injury.	
Do not turn the air-conditioner ON or OFF by plugging or unplugging the power plug. There is risk of fire or electrical shock.	





Do not use a defective or underrated circuit breaker. Use the correctly rated breaker and fuse. Otherwise there is a risk of fire or electric shock.	
Install the panel and the cover of control box securely. Otherwise there is risk of fire or electric shock due to dust, water etc.	
Indoor/outdoor wiring connections must be secured tightly and the cable should be routed properly so that there is no force pulling the cable from the connection terminals. Improper or loose connections can cause heat generation or fire.	
Do not touch, operate, or repair the product with wet hands. Holding the plug by hand when taking out. Otherwise there is risk of electric shock or fire.	
Use a vacuum pump or Inert (nitrogen) gas when doing leakage test or air purge. Do not compress air or Oxygen and Do not use Flammable gases. Otherwise, it may cause fire or explosion. - There is the risk of death, injury, fire or explosion.	

⚠ CAUTION

Do not turn on the breaker under condition that front panel and cabinet are removed.	
Be sure to earth the air conditioner with an earthing conductor connected to the earthing terminal.	
Conduct repair works after checking that the refrigerating cycle section has cooled down sufficiently. Otherwise, working on the unit, the hot refrigerating cycle section can cause burns.	
Do not tilt the unit when removing panels. Otherwise, the water inside the unit can spill and wet floor.	
Do not use the welder in a well-ventilated place. Using the welder in an enclosed room can cause oxygen deficiency.	
Be sure to turn off power switch before connect or disconnect connector, or parts damage may be occurred.	

1.2 Inspections after Repair

⚠ WARNING	
Check to see if the power cable plug is not dirty or loose. If the plug is dust or loose it can cause an electrical shock or fire.	
Do not use a joined power cable or extension cable, or share the same power outlet with other electrical appliances. otherwise, it can cause an electrical shock, excessive heat generation or fire.	
Do not insert hands or other objects through the air inlet or outlet while the product is operating. There are sharp and moving parts that could cause personal injury.	
Do not block the inlet or outlet of air flow. It may cause product failure	

⚠ CAUTION	
Check to see if the parts are mounted correctly and wires are connected. Improper installation and connections can cause an electric shock or an injury.	
Check the installation platform or frame has corroded. Corroded installation platform or frame can cause the unit to fall, resulting in injury.	
Be sure to check the earth wire is correctly connected.	
After the work has finished, be sure to do an insulation test to check the resistance is 2[Mohm] or more between the charge section and the non-charge metal section (Earth position). If the resistance value is low, a disaster such as a leak or electric shock is caused at user's side.	
Check the drainage of the indoor unit after the repair. If drainage is faulty the water to enter the room and wet floor.	

2. Model Line Up



2.1 Indoor units

Category	Chassis	Model names						
		Capacity, kW(kBtu/h Class)						
		2.1(7)	2.6 (9)	3.5 (12)	4.2(15)	5.3 (18)	7.03 (24)	10.6 (36)
Wall mounted 	SB	AMNW07GDBL1 [LMN077HVT]	AMNW09GDBL1 [LMN097HVT]	AMNW12GDBL1 [LMN127HVT]	AMNW15GDBL1 [LMN157HVT]			
	SC					AMNW18GDCL1 [LMN187HVT]	AMNW24GDCL1 [LMN247HVT]	
ART COOL Mirror 	SB		AMNW09GDBR1 [LMAN097HVT]	AMNW12GDBR1 [LMAN127HVT]				
	SC					AMNW18GDRC1 [LMAN187HVT]		
ART COOL Gallery 	SF		AMNW09GAF11 [LMAN097HVP]	AMNW12GAF11 [LMAN127HVP]				
Ceiling cassette 	TR	AMNW07GTAA0 [LMCN077HV]	AMNW09GTAA0 [LMCN097HV]	AMNW12GTAA0 [LMCN125HV]				
	TQ					AMNW18GTQA0 [LMCN185HV]		
Ceiling concealed duct Low static pressure (Slim)  High Static pressure 	L1		AMNW09GL1A0 [LMDN096HV]					
	L2			AMNW12GL2A0 [LMDN126HV]		AMNW18GL2A0 [LMDN186HV]		
	BG						AMNW24GBGA0 [LMHN240HV]	AMNW36GBGA0 [LMHN360HV]
Vertical AHU 	NJ						AMNW24GNJA0 [LMVN240HV]	AMNW36GNJA0 [LMVN360HV]

* Indicates color of panel – ART COOL : Gold(G), White Silver(H), Blue(B), Gallery(1)
 ART COOL Mirror : Mirror(R), Silver(V), White(W)

2.2 Outdoor units

Multiple Piping Type

Model Name	A2UW18GFA0 [LMU18CHV]	A3UW24GFA0 [LMU24CHV]	A4UW36GFA0 [LMU36CHV]
No. of connectable indoor units (Min. ~ Max.)	2 ~ 2	2 ~ 3	2 ~ 4
Total capacity index of connectable indoor units	24	33	48
Power supply	208/230V, 1Ø, 60Hz		
Chassis			

Branch Distribution type

Model Name	A8UW54GFA0[LMU540HV]
No. of connectable indoor units (Min. ~ Max.)	2 ~ 8
Total capacity index of connectable indoor units	73
Power supply	208/230V, 1Ø, 60Hz
Chassis	

2.3 BD(Branch distributor) units

No. of connectable indoor units(Min. ~ Max.)		1 ~ 2	1 ~ 3	1 ~ 4	
Model name		PMBD3620	PMBD3630	PMBD3640	PMBD3641
Connectable indoor unit capacity		kBtu/h		9 ~ 24	9 ~ 36
BD unit					

2.4 Branches

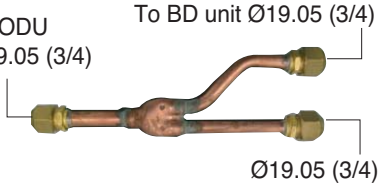
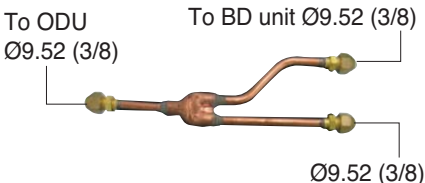
Branch Type	No. of BD Units	Accessory Model Name	Applicable Model	Specifications	
				Gas	Liquid
Y-Branch	2	PMBL5620	MULTI F MAX		

3. Nomenclature

3.1 Indoor Unit(Global)

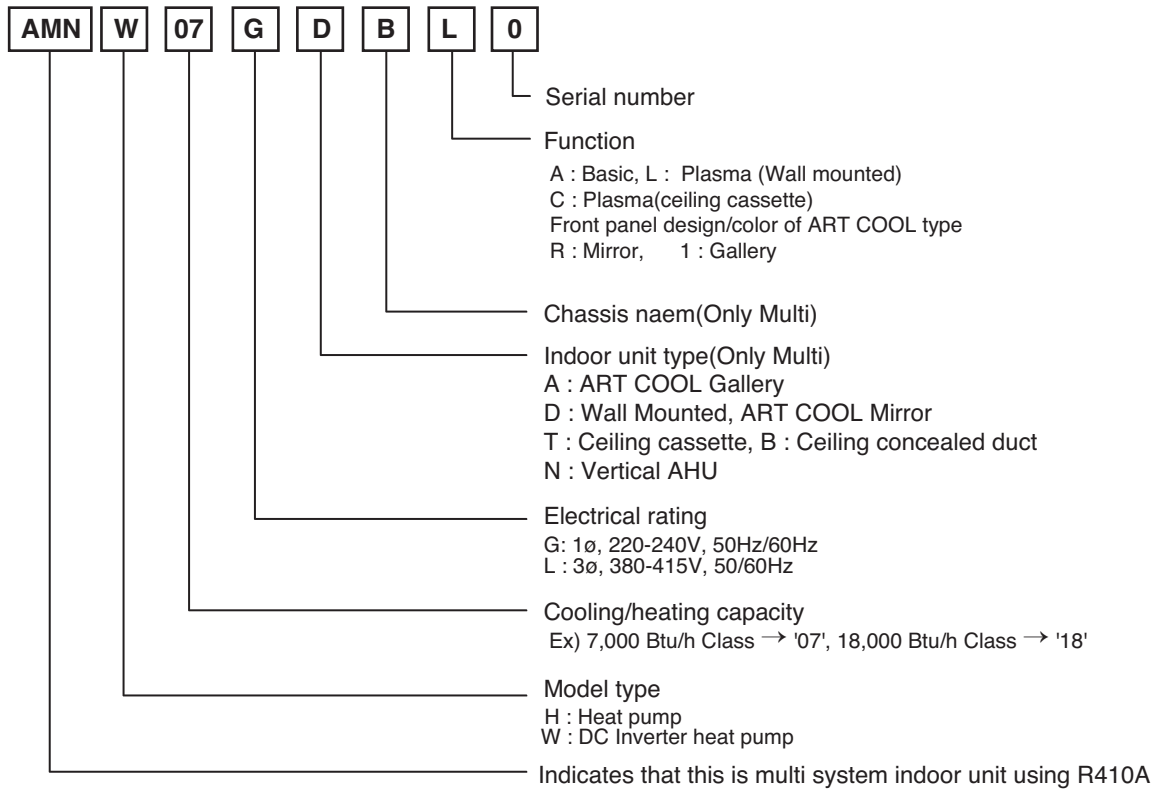

3.2 Outdoor Unit(Global)

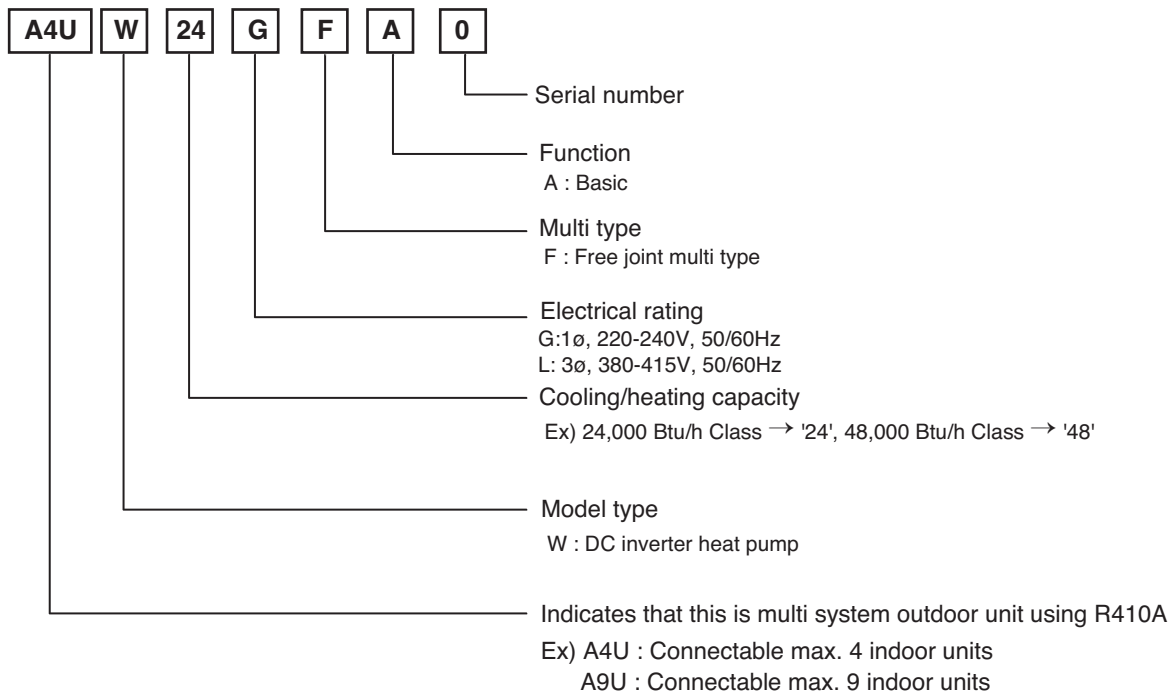

3.3 BD units(Global)

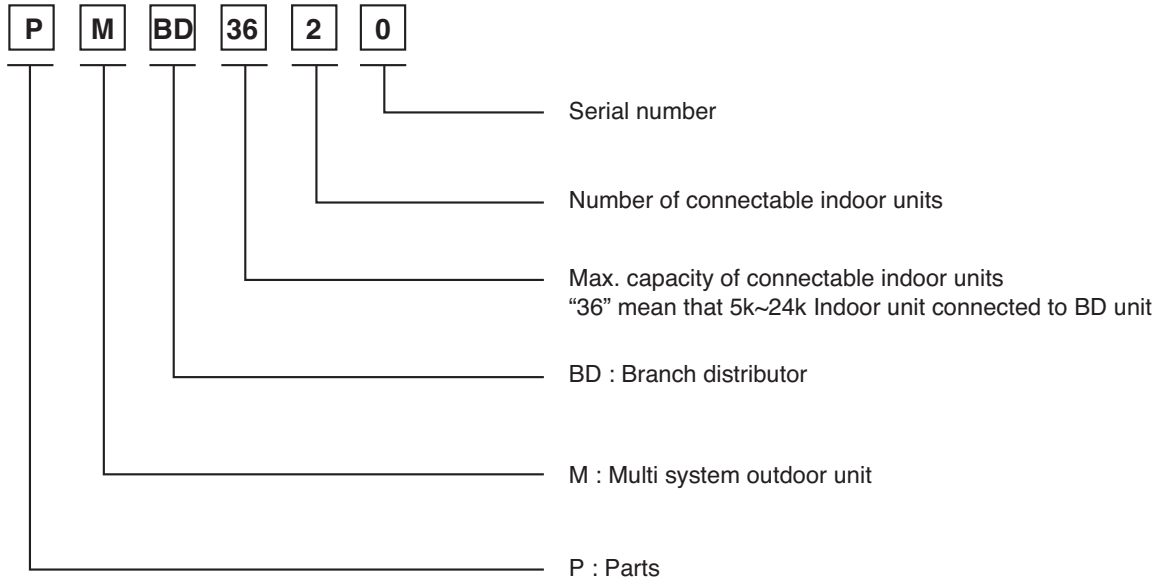

Part 2 Functions & Controls

1. List of Functions & Accessory	12
2. Air flow	14
2.1 Auto swing (left & right)	14
2.2 Auto swing (up & down)	14
2.3 Chaos swing (up/down).....	14
2.4 Air flow step.....	15
2.5 Chaos wind (auto wind).....	15
2.6 Jet Cool Mode Operation	15
2.7 Swirl wind Swing	15
3. Air purifying	16
3.1 PLASMA Air Purifying System	16
4. Installation Functions	17
4.1 E.S.P. (External Static Pressure) Setting	17
5. Reliability	18
5.1 Hot start.....	18
5.2 Self-diagnosis Function.....	18
5.3 Soft dry operation.....	18
6. Convenience Functions & Controls	19
6.1 Cooling & heating Operations	19
6.2 Auto cleaning operation	20
6.3 Auto Operation (Artificial Intelligence).....	20
6.4 Auto restart Opeartion.....	21
6.5 Child Lock Function.....	22
6.6 Forced operation	22
6.7 Group Control.....	23
6.8 Sleep Timer Operation	24
6.9 Timer(On/Off)	24
6.10 Weekly Program.....	24
6.11 Two Thermistor Control	25
7. Special Function & KIT	26
7.1 Low Ambient control.....	26
7.2 Space Control	26
7.3 Auto Elevation Grille.....	26
7.4 Defrost Control(Heating)	28

1. List of Functions & Accessory

1.1 List of Functions

• Indoor

Category	Functions	Wall Mounted	ART COOL Mirror	ART COOL Gallery	Ceiling cassette 4-way	Ceiling concealed duct (Low static pressure)	Ceiling concealed duct (High static pressure)	Vertical Air Handling Unit
Air flow	Air supply outlet	1	1	3	4	1	1	1
	Airflow direction control (left & right)	Auto	Auto	Auto	X	X	X	X
	Airflow direction control (up & down)	Auto	Auto	Auto	Auto	X	X	X
	Auto swing (left & right)	O	O	O	X	X	X	X
	Auto swing (up & down)	O	O	O	O	X	X	X
	Airflow steps (fan/cool/heat)	6 / 6 / 6	6 / 6 / 6	5 / 5 / 5	4 / 5 / 4	3 / 3 / 3	3 / 3 / 3	3 / 3 / 3
	Chaos wind(auto wind)	O	O	O	O	X	X	X
	Jet cool/heat	O / O	O / O	O / O	O / X	X / X	X / X	X / X
Air purifying	Swirl wind	X	X	X	O	X	X	X
	Triple filter (Deodorizing)	X	X	X	X	X	X	X
	Ventilation Kit	-	-	-	PTVK430	X	X	X
	Plasma air purifier	O	O	X	PTPKQ0	X	X	X
	Allergy Safe filter	X	X	X	X	X	X	X
Installation	Long-life prefilter (washable / anti-fung)	O	O	O	O	O	O	X
	Drain pump	X	X	X	O	O	O	X
	E.S.P. control	X	X	X	X	O	O	O
	Electric heater	X	X	X	X	X	X	ANEH053B1(5kW) ANEH103B2(10kW)
	High ceiling operation	X	X	X	O	X	X	X
	Auto Elevation Grille	X	X	X	X	X	X	X
Reliability	Hot start	O	O	O	O	O	O	O
	Self diagnosis	O	O	O	O	O	O	O
	Soft dry operation	O	O	O	O	O	O	O
Convenience	Auto changeover	X	X	X	X	X	X	X
	Auto cleaning	O	O	O	X	X	X	X
	Auto operation(artificial intelligence)	O	O	O	O	O	O	O
	Auto Restart	O	O	O	O	O	O	O
	Child lock*	O	O	O	O	O	O	O
	Forced operation	O	O	O	O	X	X	X
	Group control*	O	O	O	O	O	O	O
	Sleep mode	O	O	O	O	O	X	O
	Timer(on/off)	O	O	O	O	O	X	O
	Timer(weekly)*	O	O	O	O	O	X	O
Individual control	Two thermistor control*	O	O	O	O	O	O	O
	Standard Wired remote controller	PREMTB10U						
	Deluxe wired remote controller	X	X	X	X	X	X	X
	Simple wired remote controller	PQRCVCL0Q / PQRCVCL0QW				O	O	O
	Simple wired remote controller(for hotel use)	X	X	X	X	X	X	X
Network function	Wireless remote controller*	O	O	O	O	PQWRHQ0FDB		
	General central controller (Non LGAP)	X	X	X	X	X	X	X
	Network Solution(LGAP)	O	O	O	O	O	O	O
	Dry contact	PQDSA(1)/PQDSB(1) / PQDSBC / PQDSBNGCM1						
Special function kit	PI 485(for Indoor Unit)	X	X	X	X	X	X	X
	Zone controller	X	X	X	X	X	X	X
	CTI(Communication transfer interface)	X	X	X	X	X	X	X
Others	Electronic thermostat	X	X	X	X	X	X	X
	Remote temperature sensor	X	X	X	PQRSTA0			
	Group control wire	PZCWRCG3						
	Telecom shelter controller	X	X	X	X	X	X	X
	Connector for water level sensor	O	X	O	X	X	X	X

[Note]

O : Applied, X : Not applied

Accessory model name : Installed at field, ordered and purchased separately by the corresponding model name, supplied with separate package.

• Outdoor

Category	Functions	Remark
Reliability	Defrost / Deicing	O
	High pressure switch	X
	Low pressure switch	X
	Phase protection	X
	Restart delay (3-minutes)	O
	Self diagnosis	O
	Soft start	O
	Test function	X
Convenience	Night Silent Operation	O
Network function	Network solution(LGAP)	O

[Note]

○ : Applied, × : Not applied

* Option : Model name & price are different according to options, and assembled in factory with main unit.

Accessory model name : Installed at field, ordered and purchased separately by the corresponding model name, supplied with separate package.

1.2 List of Accessory

	Device	Remark
Central Controller	Simple Controller	X
	Function controller	X
	Function Scheduler	X
	AC Ez	PQCSZ250S0
	AC Smart II	PQCSW320A1E
	Option Kit (SD card type)	PQCSE341A0 / PQCSE342A0
	ACP(Advanced Control Platform)	PQCPA11A0E / PQCPB11A0E
	AC Manager	X
	PI485	PMNFP14A0/PMNFP14A1
	DO(Digital Output) Kit	PQNFP00T0
BNU	LONWORKS Gateway	PQNFB16A1
(Building Network Unit)	BACnet Gateway	PQNFB17B0
Installation	Y branch	Accessory
	Header branch	Accessory
	Air Guide	X
ODU Dry Contact		X
Low Ambient Kit		O (Logical operation)

2. Air flow

2.1 Auto swing (left & right)

- By the horizontal airflow direction control key input, the left/right louver automatically operates with the auto swing or it is fixed to the desired direction.

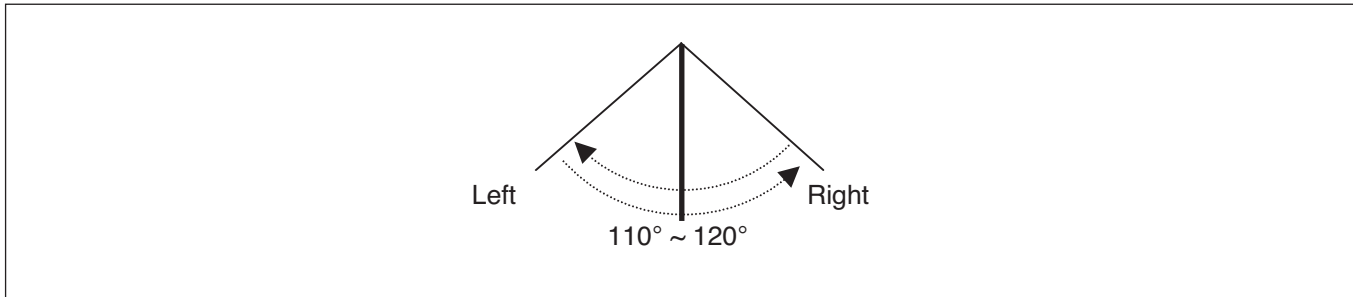

2.2 Auto swing (up & down)

- By the auto swing key input, the upper/lower vane automatically operates with the auto swing or it is fixed to the desired direction.

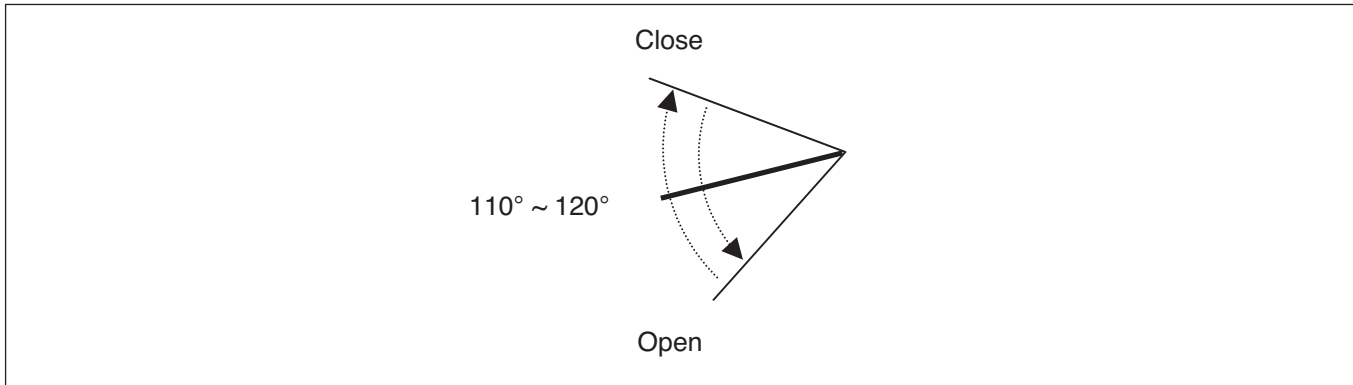

2.3 Chaos swing (up/down)

- By the Chaos swing key input, the upper/lower vane automatically operates with the chaos swing or it is fixed to the desired direction.

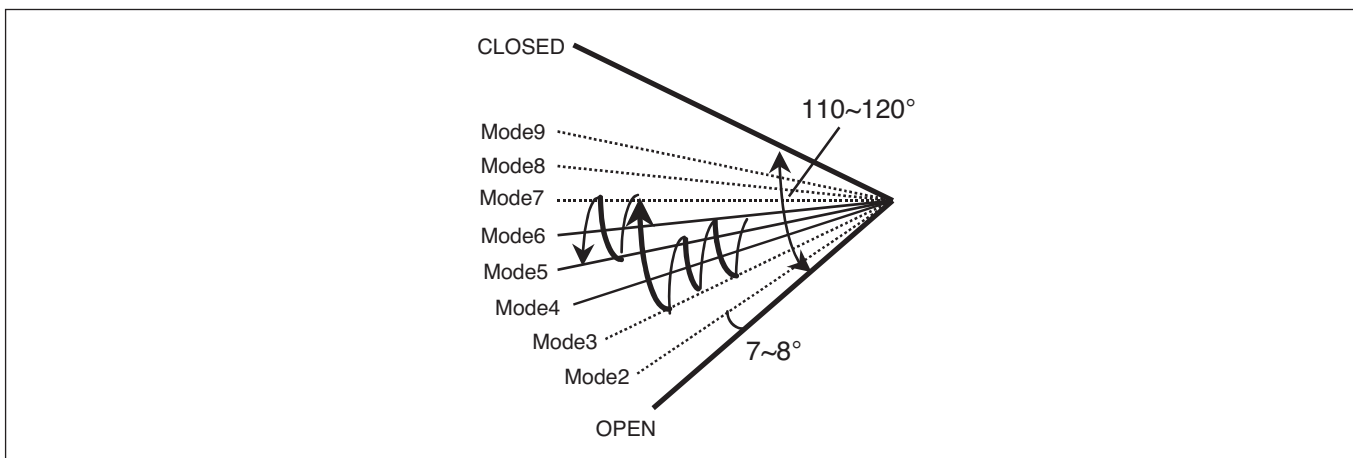

NOTE: Some Models are different by swing width and swing pattern.

2.4 Air flow step

- Indoor fan motor control have 6 steps.
- Air volume is controlled "SH", "H", "Med", "Low" by remote controller.
- "LL" step is selected automatically in Hot start operation.

Step	Discription
LL	Very low, In heating mode
L	Low
M	Med
H	High
SH	Super high
Auto	Chaos wind

2.5 Chaos wind (auto wind)

- When "Auto" step selected and then operated, the high, medium, or low speed of the airflow mode is operated for 2~15 sec. randomly by the Chaos Simulation

2.6 Jet Cool Mode Operation

- While in heating mode or Fuzzy operation, the Jet Cool key cannot be input. When it is input while in the other mode operation (cooling, dehumidification, ventilation), the Jet Cool mode is operated.
- In the Jet Cool mode, the indoor fan is operated at super-high speed for 30 min. at cooling mode operation.
- In the Jet Cool mode operation, the room temperature is controlled to the setting temperature, 18°C.
- When the sleep timer mode is input while in the Jet Cool mode operation, the Jet Cool mode has the priority.
- When the Jet Cool key is input, the upper/lower vanes are reset to those of the initial cooling mode and then operated in order that the air outflow could reach further.

2.7 Swirl wind Swing

- It is the function for comfort cooling/heating operation.
- The diagonal two louvers are opened the more larger than the other louvers. After one minute, it is opposite.

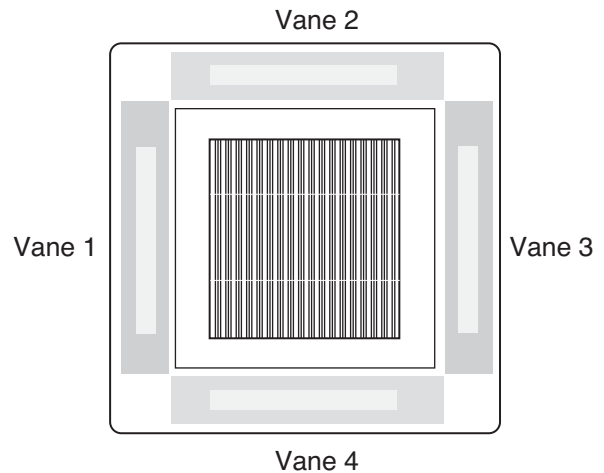

- Comparison of Air Flow Types

4-Open (conventional)

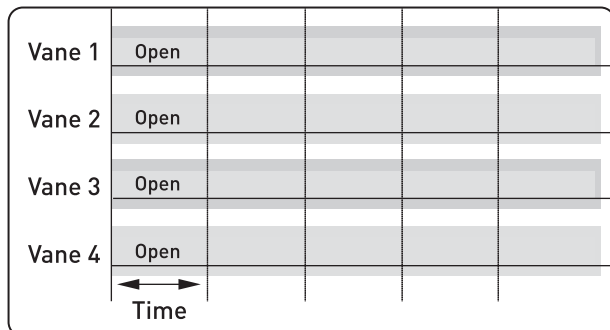

Swirl Swing (New)

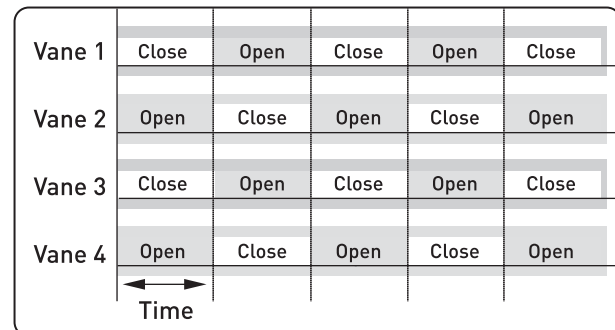

3. Air purifying

3.1 PLASMA Air Purifying System

The PLASMA Air Purifying System not only removes microscopic contaminants and dust, but also removes house mites, pollen, and pet fur to help prevent allergic diseases like asthma. This filter that can be used over and over again by simply washing with water.

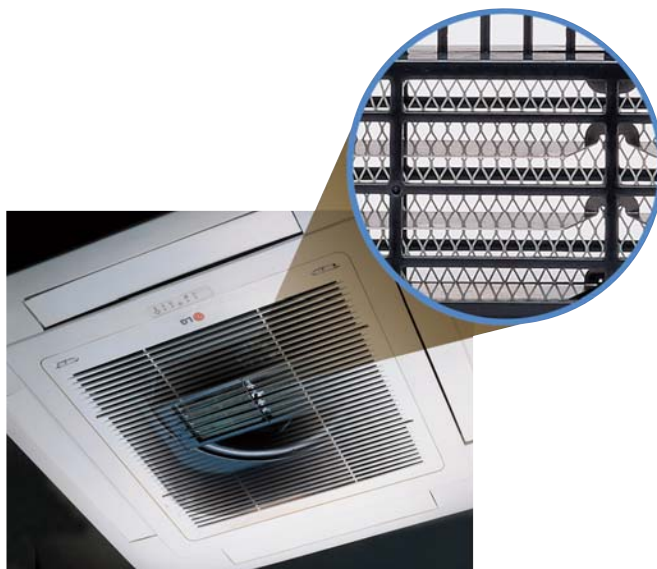
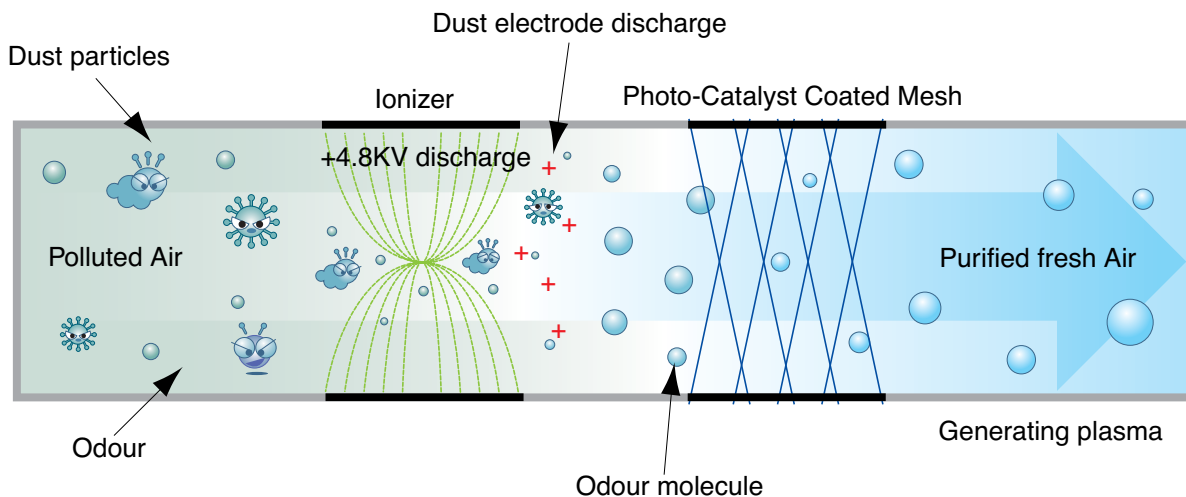

4. Installation Functions

4.1 E.S.P. (External Static Pressure) Setting

This is the function that decides the strength of the wind for each wind level and because this function is to make the installation easier.

- If you set ESP incorrectly, the air conditioner may malfunction.
- This setting must be carried out by a certificated-technician.

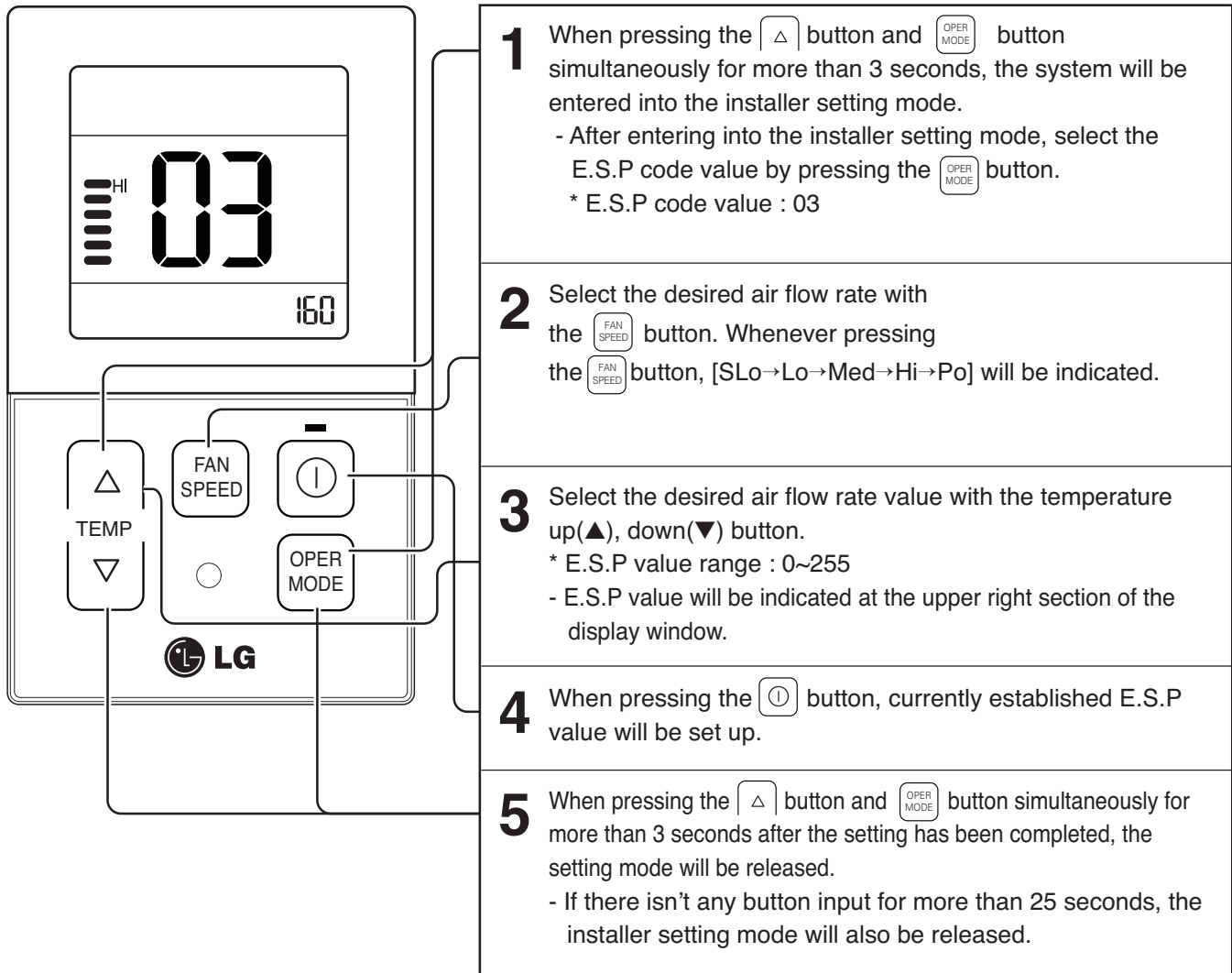

- Precaution shall be taken not to alter the E.S.P value corresponded to each air flow section.
- E.S.P value can be varied according to the products.
- In the case of going to the next air flow rate stage by pressing the fan-speed button during the setup of the E.S.P value, the E.S.P value of previous air flow rate will be maintained by remembering the E.S.P value prior to the shift.

5. Reliability

5.1 Hot start

- When heating is started, the indoor fan is stopped or very slow to prevent the cold air carry out
- When the temp. of heat exchanger reach 30°C(model by model), indoor fan is started.

5.2 Self-diagnosis Function

- The air conditioner installed can self-diagnosed its error status and then transmits the result to the central control. Therefore, a rapid countermeasure against failure of the air conditioner allows easy management and increases the usage life of air conditioner.
- Refer to trouble shooting guide.

5.3 Soft dry operation

- When the dehumidification operation input by the remote control is received, the intake air temperature is detected and the setting temp is automatically set according to the intake air temperature.

Intake air Temp.	Setting Temp.
26°C ≤ intake air temp.	25°C
24°C ≤ intake air temp. < 26°C	intake air temp. -1°C
22°C ≤ intake air temp. < 24°C	intake air temp. -0.5°C
18°C ≤ intake air temp. < 22°C	intake air temp.
intake air temp. < 18°C	18°C

- While compressor off, the indoor fan repeats low airflow speed and stop.
- While the intake air temp is between compressor on temp. and compressor off temp., 10-min dehumidification operation and 4-min compressor off repeat.

Compressor ON Temp. → Setting Temp+0.5°C
 Compressor OFF Temp. → Setting Temp-0.5°C

- In 10-min dehumidification operation, the indoor fan operates with the low airflow speed.

6. Convenience Functions & Controls

6.1 Cooling & heating Operations

6.1.1 Cooling Mode

- Operating frequency of compressor depends on the load condition, like the difference between the room temp. and the set temp., frequency restrictions.
- If the compressor operates at some frequency, the operating frequency of compressor cannot be changed within 30 seconds. (not emergency conditions)
- Compressor turned off when
 - intake air temperature is in between $\pm 0.5^{\circ}\text{C}$ of the setting temp. limit for three minutes continuously.
 - intake air temperature reaches below 1.0°C of the temperature of setting temp..
- Compressors three minutes time delay.
 - After compressor off, the compressor can restart minimum 3 minutes later.

6.1.2 Heating Mode

- Operating frequency of compressor depend on the load condition, The difference between the room temp. and set temp., frequency restrictions.
- If compressor operates at some frequency, the operating frequency of compressor cannot be changed within 30 seconds.
- Condition of compressor turned off
 - When intake air temperature reaches $+4^{\circ}\text{C}$ above the setting temperature.
- Condition of compressor turned on
 - When intake air temperature reaches $+2^{\circ}\text{C}$ above the setting temperature.
- * Condition of indoor fan turned off
 - While in compressor on : indoor pipe temp. $< 20^{\circ}\text{C}$
 - While in compressor off : indoor pipe temp. $< 30^{\circ}\text{C}$
- While in defrost control, between the indoor and outdoor fans are turned off.
- Compressor 2minutes delay
 - After compressor off, the compressor can restart minimum 2 minutes later.

NOTE: Some Models are different by temperature of thermo ON/OFF.

CST/Duct type indoor unit matched with Universal Outdoor unit	CST/ Duct/CVT type indoor unit matched with Single Outdoor unit/Multi Outdoor unit/Multi V Outdoor unit
Thermo ON : $+2^{\circ}\text{C}$ above setting temp. Thermo OFF : $+4^{\circ}\text{C}$ above setting temp.	Thermo ON : Setting temp. Thermo OFF : $+3^{\circ}\text{C}$ above setting temp.

6.2 Auto cleaning operation

- Function used to perform Self Cleaning to prevent the Unit from Fungus and bad odor.
- Used after the Cooling Operation before turning the unit off, clean the Evaporator and keep it dry for the next operation.
- The function is easy to operate as it is accessed through the Remote controller.

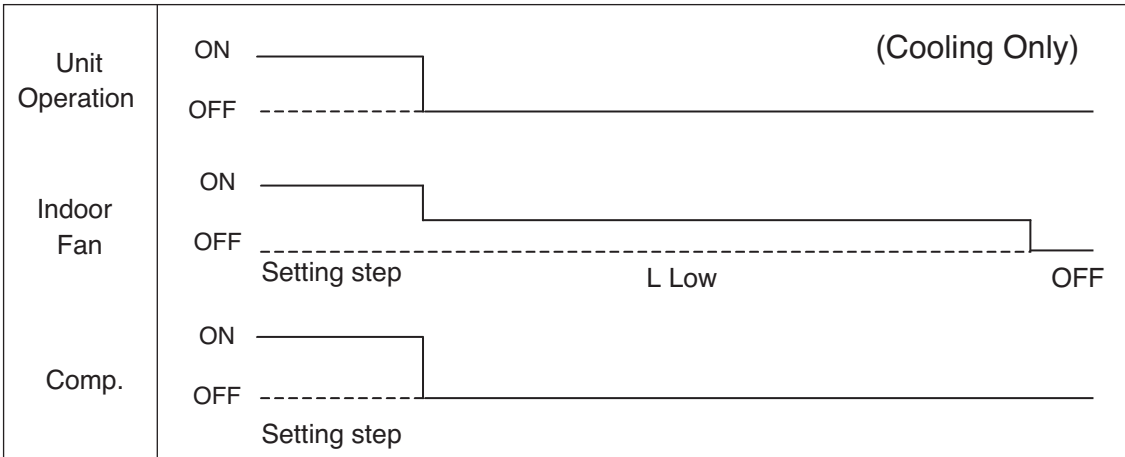

6.3 Auto Operation (Artificial Intelligence)

- When any of operation mode is not selected like the moment of the power on or when 3 hrs has passed since the operation off, the operation mode is selected.
- When determining the operation mode, the compressor, the outdoor fan, and the 4 way valve are off and only the indoor fan is operated for 15 seconds. Then an operation mode is selected according to the intake air temp at that moment as follows.
 - 24°C ≤ Intake Air Temp → Fuzzy Operation for Cooling
 - 21°C ≤ Intake Air Temp < 24°C → Fuzzy Operation for Dehumidification
 - Intake Air Temp < 21°C → Fuzzy Operation for Heating
- If any of the operation modes among cooling / dehumidification / heating mode operations is carried out for 10 sec or longer before Fuzzy operation, the mode before Fuzzy operation is operated.

6.3.1 Fuzzy Operation for Cooling

- According to the setting temperature selected by Fuzzy rule, when the intake air temp is 0.5°C or more below the setting temp, the compressor is turned off. When 0.5°C or more above the setting temp, the compressor is turned on.
 - Compressor ON Temp → Setting Temp + 0.5°C
 - Compressor OFF Temp → Setting Temp - 0.5°C
- At the beginning of Fuzzy mode operation, the setting temperature is automatically selected according to the intake air temp at that time.
 - 26°C ≤ Intake Air Temp → 25°C
 - 24°C ≤ Intake Air Temp < 26°C → Intake Air Temp + 1°C
 - 22°C ≤ Intake Air Temp < 24°C → Intake Air Temp + 0.5°C
 - 18°C ≤ Intake Air Temp < 22°C → Intake Air Temp
 - Intake Air Temp < 18°C → 18°C
- When the Fuzzy key (Temperature Control key) is input after the initial setting temperature is selected, the Fuzzy key value and the intake air temperature at that time are compared to select the setting temperature automatically according to the Fuzzy rule.
- While in Fuzzy operation, the airflow speed of the indoor fan is automatically selected according to the temperature.

6.3.2 Fuzzy Operation for Dehumidification

- According to the setting temperature selected by Fuzzy rule, when the intake air temp is 0.5°C or more below the setting temp, the compressor is turned off. When 0.5°C or more above the setting temp, the compressor is turned on.
Compressor ON Temp → Setting Temp + 0.5°C
Compressor OFF Temp → Setting Temp+0.5°C
- At the beginning of Fuzzy mode operation, the setting temperature is automatically selected according to the intake air temp at that time.
26°C ≤ Intake Air Temp → 25°C
24°C ≤ Intake Air Temp < 26°C → Intake Air Temp + 1°C
22°C ≤ Intake Air Temp < 24°C → Intake Air Temp + 0.5°C
18°C ≤ Intake Air Temp < 22°C → Intake Air Temp
Intake Air Temp < 18°C → 18°C
- When the Fuzzy key (Temperature Control key) is input after the initial setting temperature is selected, the Fuzzy key value and the intake air temperature at that time are compared to select the setting temperature automatically according to the Fuzzy rule.
- While in Fuzzy operation, the airflow speed of the indoor fan repeats the low airflow speed or pause as in dehumidification operation.

6.3.3 Fuzzy Operation for Heating

- According to the setting temperature selected by Fuzzy rule, when the intake air temp is 3°C or more above the setting temp, the compressor is turned off. When below the setting temp, the compressor is turned on.
Compressor ON Temp → Setting Temp
Compressor OFF Temp → Setting Temp + 3°C
- At the beginning of Fuzzy mode operation, the setting temperature is automatically selected according to the intake air temp at that time.
20°C ≤ Intake Air Temp → Intake Air Temp + 0.5°C
Intake Air Temp < 20°C → 20°C
- When the Fuzzy key (Temperature Control key) is input after the initial setting temperature is selected, the Fuzzy key value and the intake air temperature at that time are compared to select the setting temperature automatically according to the Fuzzy rule.
- While in Fuzzy operation, the airflow speed of the indoor fan is set to the high or the medium according to the intake air temperature and the setting temperature.

Notes: The Temp. of Comp. Turn ON and OFF is different in heating mode and fuzzy operation for heating. Please, refer page 11



6.4 Auto restart Operation



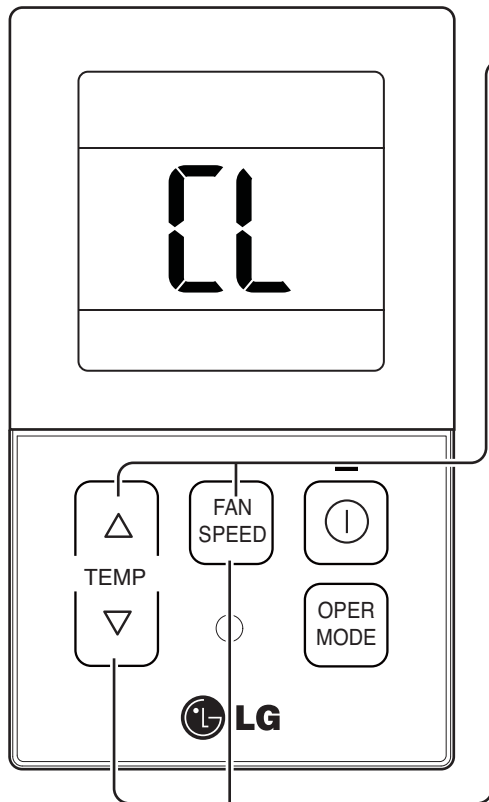

- Whenever there is electricity failure to the unit, and after resumption of the power, unit will start in the same mode prior to the power failure. Memorized condition are on / off condition, operating mode (cooling/ heating), set temperature and fan speed. The unit will memorize the above conditions and start with same memorized condition.

6.5 Child Lock Function

It is the function to use preventing children or others from careless using.



- 1** During the operation, when pressing the  button and  button for approx. 3 seconds, the 'Child Lock' Function can be used.

 - At the time of initial setting of the 'Child Lock', the 'CL' Will be indicated approx. 3 seconds at the temperature Display section before resuming to the previous mode.
 - After the setting of the 'CL', if another button is setup, the button can not be recognized as the 'CL' is indicated at the temperature display section for approx. 3 seconds.
- 2** If the 'CL' function is wanted to be used under the operation standby state, press the  button and  Button for approx. 3 seconds under the standby mode state and the system will be the 'CL' state.
- 3** As for the releasing method, when pressing the  Button and  button for approx. 3 seconds, the 'CL' function can be released.

6.6 Forced operation

- To operate the appliance by force in case when the remote control is lost, the forced operation selection switch is on the main unit of the appliance, and operate the appliance in the standard conditions.
- The operating condition is set according to the outdoor temp. and intake air temperature as follows.

Indoor temp.	Operating Mode	Setting temp.	Setting speed of indoor fan
over 24°C	Cooling	22°C	High speed
21~24°C	Healthy Dehumidification	23°C	
below 21°C	Heating	24°C	

- The unit select the last operation mode in 3 hours.
- Operating procedures when the remote control can't be used is as follows :
 - The operation will be started if the ON/OFF button is pressed.
 - If you want to stop operation, re-press the button.

6.7 Group Control

1. When installing more than 2 units of air conditioner to one wired remote controller, please connect as the right figure.

- If it is not event communication indoor unit, set the unit as slave.
- Check for event communication through the product manual.

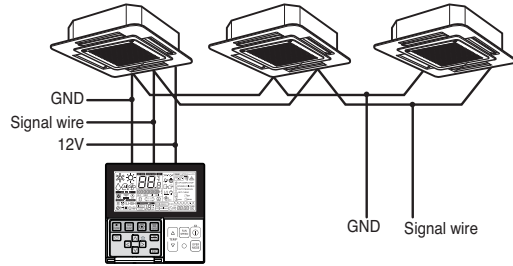

When controlling multiple indoor units with event communication function with one remote controller, you must change the master/slave setting from the indoor unit.

- Indoor units, the master/slave configuration of the product after completion of indoor unit power 'OFF' and then 'ON' the power after 1 minutes elapsed sign up.
- For ceiling type cassette and duct product group, change the switch setting of the indoor PCB.

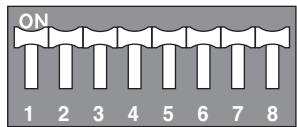

#3 switch OFF: Master
(Factory default setting)

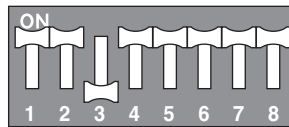

#3 switch ON: Slave

- For wall-mount type and stand type product, change the master/slave setting with the wireless remote controller. (Refer to wireless remote controller manual for detail)
- * When installing 2 remote controllers to one indoor unit with event communication function, set the master/slave of the remote controller. (Refer to remote controller master/slave selection)
When controlling the group, some functions excluding basic operation setting, fan level Min/Mid/Max, remote controller lock setting and time setting may be limited.

2. When installing more than 2 wired remote controllers to one air conditioner, please connect as the right picture.

- When installing more than 2 units of wired remote controller to one air conditioner, set one wired remote controller as master and the others all as slaves, as shown in the right picture.
- You cannot control the group as shown in the right for some products.
- Refer to the product manual for more detail.

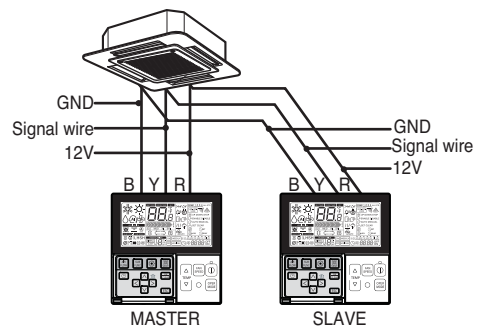

<When simultaneously connecting 2 sets of wired remote controller>

- When controlling in groups, set the master/slaver of the remote controller. Refer to Installer setting section on how to set master/slave for more detail.

6.8 Sleep Timer Operation

- When the sleep time is reached after <1,2,3,4,5,6,7,0(cancel) hr> is input by the remote control while in appliance operation, the operation of the appliance stops.
- While the appliance is on pause, the sleep timer mode cannot be input.
- While in cooling mode operation, 30 min later since the start of the sleep timer, the setting temperature increases by 1°C. After another 30 min elapse, it increases by 1°C again.
- When the sleep timer mode is input while in cooling cycle mode, the airflow speed of the indoor fan is set to the low.
- When the sleep timer mode is input while in heating cycle mode, the airflow speed of the indoor fan is set to the medium.

6.9 Timer(On/Off)

6.9.1 On-Timer Operation

- When the set time is reached after the time is input by the remote control, the appliance starts to operate.
- The timer LED is on when the on-timer is input. It is off when the time set by the timer is reached.
- If the appliance is operating at the time set by the timer, the operation continues.
While in Fuzzy operation, the airflow speed of the indoor fan is automatically selected according to the temperature.

6.9.2 Off-Timer Operation

- When the set time is reached after the time is input by the remote control, the appliance stops operating.
- The timer LED is on when the off-timer is input. It is off when the time set by the timer is reached.
- If the appliance is on pause at the time set by the timer, the pause continues.

6.10 Weekly Program

- If necessary, an operator can make an On/Off reservation of the product for a period of one week.
- On/Off schedule of operation for a period of ONE week.
- No need to turn the unit On/OFF manually during working days.
On/Off time is scheduled in micom of the wired remote control.





Operation Time Table (Example)

Setting	Mon	Tue	Wed	Thu	Fri	Sat	Sun
Temp.	25°C	25°C	25°C	25°C	25°C	OFF	
On	09:00	08:00	09:00	08:00	09:00		
Off	12:00	17:00	12:00	12:00	12:00		

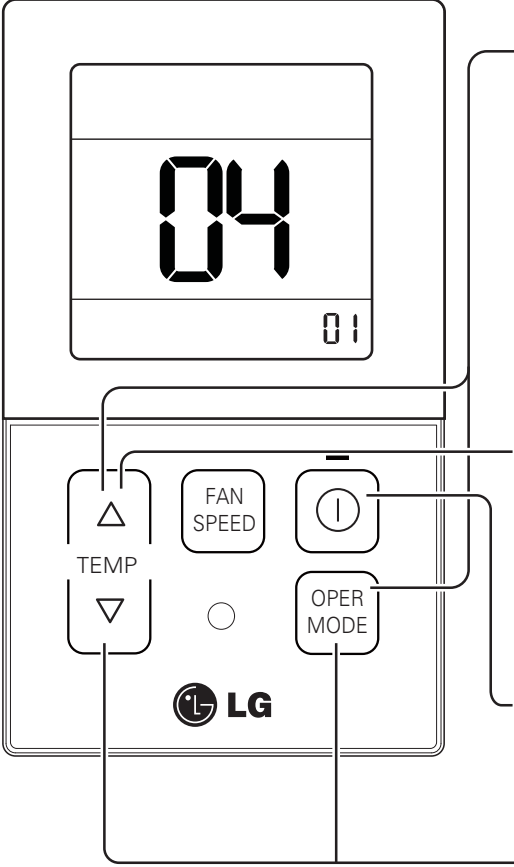
6.11 Two Thermistor Control

This is the function to select the temperature sensor to judge the room temperature.



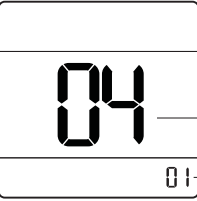

- 1** When pressing the  button and  button simultaneously for more than 3 seconds, the system will be entered into the installer setting mode.
 - After entering into the installer setting mode, select the  thermistor sensor setting code value by pressing the button.
 - * Thermistor sensor selection code value : 04
- 2** Select the desired setting value with the temperature up() , down() button.



*Setting value

01: Remote controller

02: Indoor unit

03: 2TH
- 3** When pressing the  button, currently established thermistor sensor location will be set up.
- 4** When pressing the  button and  button simultaneously for more than 3 seconds after the setting has been completed, the setting mode will be released.
 - If there isn't any button input for more than 25 seconds, the installer setting mode will also be released.

<Thermistor Table>

Temperature sensor selection		Function
01	Remote controller	Operation in remote controller temperature sensor
02	Indoor unit	Operation in indoor unit temperature sensor
03	2TH	Cooling Operation of higher temperature by comparing indoor unit's and wired remote controller's temperature. (There are products that operate at a lower temperature.)
		Heating Operation of lower temperature by comparing indoor unit's and wired remote controller's temperature.

* The function of 2TH has different operation characteristics according to the product.

7. Special Function & KIT

7.1 Low Ambient control

- This Function is for cooling operating in outdoor low temperature .
- If outdoor temperature drops below certain temperature, liquid back is prevented by reducing outdoor fan speed.
- It can prevent frosting of evaporator and keep cooling operation

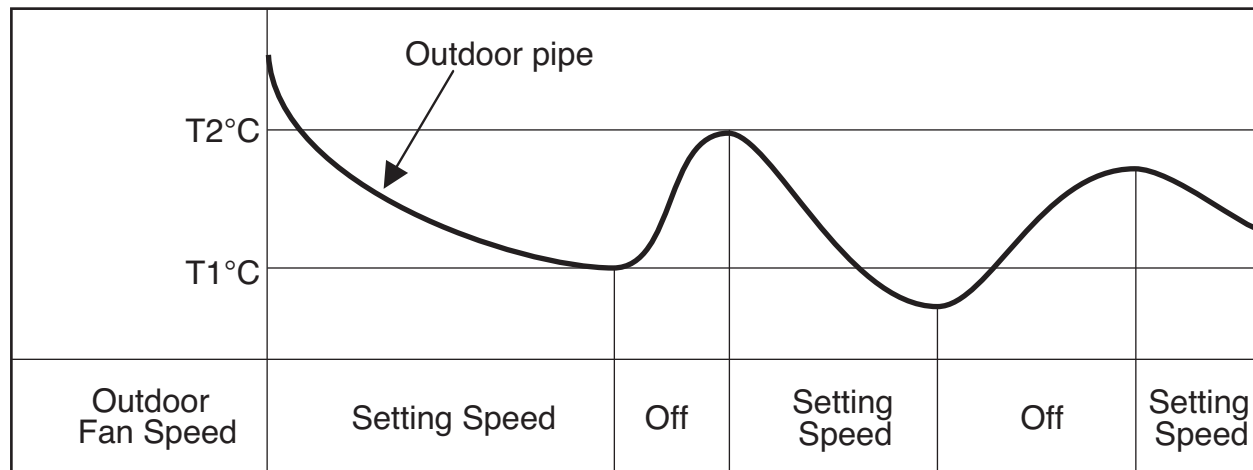

7.2 Space control

Vanes angle can be controlled by pair, considering its installation environment.

- For example direct drafts can be annoying, leading to discomfort and reduced productivity vane control helps to eliminate this problem.
- Easily controlled by wired remote control.
- Air Flow can be controlled easily regarding any space environment.

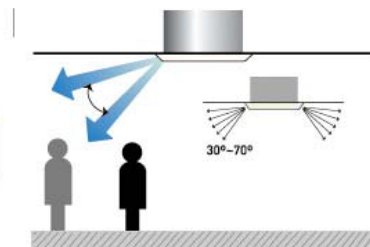
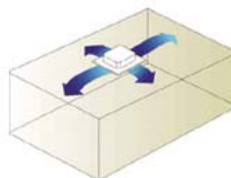

7.3 Auto Elevation Grille

- Auto Elevation Grille is automatically down to height of max. 3.1 m. So it enables to install the Indoor unit at high ceiling space. And Auto Elevation Grille makes you cleaning the filter easily.

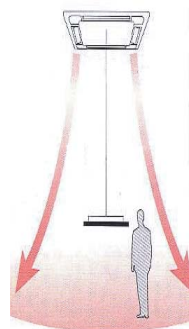

■ ELEVATION GRILL (REMOTE CONTROLLER_Accessory)

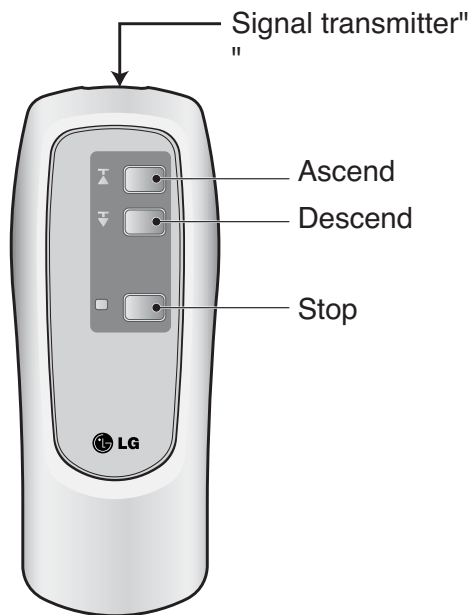

• Main Components of Lift Grill

- ① Lift grill front panel assembly
- ② Bolts for installation (4 EA, P/No. 3A00255K)
- ③ Instruction manual
- ④ Remote Controller for lift grill

• How to Use Remote Controller

As for operation of Remote Controller, use it by directing the transmitter part of Remote Controller to the receiver part of front panel directly under front panel.

- Do not drop it down or into water. Or else there is worry about trouble failure.
- Do not press hard the Remote Controller button with nail (ball-point pen or other sharp substance). Or else there is worry about trouble failure.
- In case when obstacle such as curtain hides the signal reception part of receiver in between the space interval, Remote Controller operation is infeasible.

• How to Operate the Lift Grill

⚠ CAUTION

- Always stop the air conditioner operation for safety before operating lift grill.
- Take heed _ there is worry about dust fall etc. when suction grill descends.
- In case when the set automatic stop distance goes wrong, check the set value of operation panel and confirm if there is neither obstacle nor mankind.
- When you are not to remove obstacle, stop the operation before touching the obstacle.

1. Stop the Air Conditioner Operation

Automatic Stop Distance of Grill

2. Descend the Suction Grill

- Depress the down button(▼).
Then suction grill descends and stops automatically at a certain distance.
- You may stop it at wanted distance point by depressing the stop button (■) when descending.

3. Raise the Suction Grill

- Depress the up button(▲).
Then suction grill goes up and enters into the front panel.

4. Stop the Suction Grill during Rising

- Depress the stop button(■).
Make use of this when you want to stop it at your wished position.

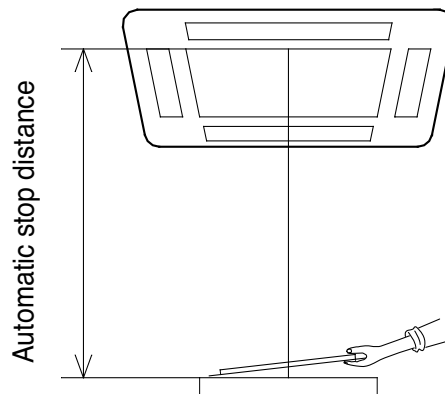

Ceiling height	Low	Medium (Height: 3~4 m)	High
Automatic stop distance	1.5±0.5 m	2.5±0.5 m	3.5±0.5 m

* If you want to change automatic distance setting, consult with your sale agency.

7.4 Defrost Control (Heating)

- Defrost operation is controlled by timer and sensing temperature of outdoor pipe.
- The first defrost starts only when the outdoor pipe temperature falls below -11°C after starting of heating operation and more than 10 minutes operation of compressor.
- Defrost ends after 15 minutes passed from starting of defrost operation when the outdoor rises over 40°C even before 12 minutes.
- The second defrost starts only when the outdoor pipe temperature falls below – 6°C after from ending of the first defrost and more than 10 minutes operation of compressor.

Part 3. Basic Control

1. Normal operation	30
2 Compressor control	30
3. EEV(Electronic Expansion Valve) control	30
4. Oil return control	31
5. Defrost control	31
6. Protection control	32
6.1 High pressure protection control	32
6.2 Low pressure protection control	32
6.3 Discharge temperature control	32
6.4 Input Current control	32

1. Normal operation

Basic principle is to control the rpm of the motor by changing the working frequency of the compressor. Three phase voltage is supplied to the motor and the time for which the voltage will supplied is controlled by IPM (intelligent power module). Switching speed of IPM defines the variable frequency input to the motor.

Actuator	Cooling operation	Heating operation	Stop state
Compressor	Fuzzy control	Fuzzy control	Stop
Fan	Fuzzy control	Fuzzy control	Stop
EEV	Super heating fuzzy control	Super heating & Sub cooling fuzzy control	Min. Pulse

※ 14,16k Models

Frequency that corresponds to each rooms capacity will be determined according to the difference in the temperature of each room and the temperature set by the remote controller. There are various factors determining the frequency.

2. Compressor control

Fuzzy control : Maintain evaporating temperature (Te) to be constant on cooling mode and constant condensing temperature (Tc) on heating mode by fuzzy control to ensure the stable system performance.

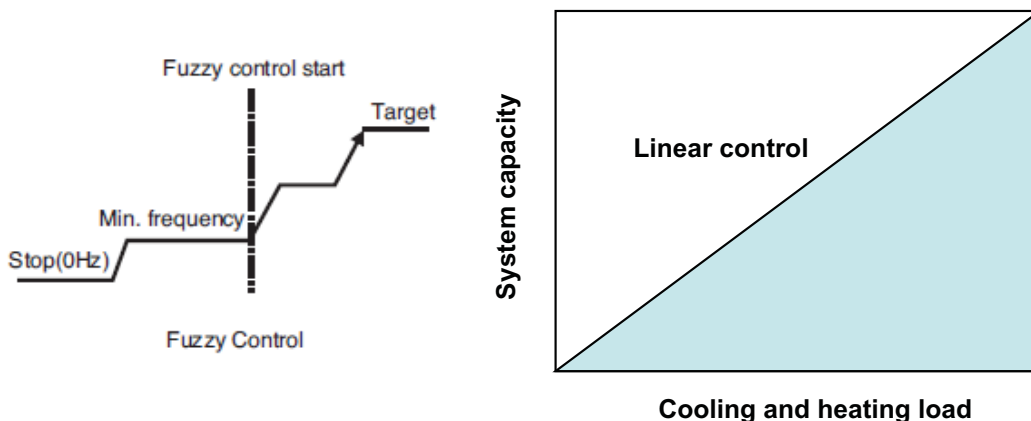

Inverter linear control as cooling and heating load increasing

※ 14, 16k Models

Capacity steps of compressor are decided by summation of capacity code, outdoor temp., indoor temp., step compensation of temperature difference indoor temp. and setting temp.

3. EEV(Electronic Expansion Valve) control

EEV operates with fuzzy control rules to keep the degree of superheat (about 2~3°C) at the evaporator outlet status. The degree of superheat = $T_{\text{suction}} - T_{\text{evaporation}}$
 T_{suction} : temperature at suction pipe sensor(°C)
 $T_{\text{evaporation}}$: evaporation temperature (°C)

※ 14, 16k Models

EEV operates with PI control rules to keep the degree of superheat at the evaporator inlet and outlet status.

4. Oil return control

Oil return operation recovers oil amount in compressor by collecting oil accumulated in pipe. Each cycle component operates as shown on the below table during oil return operation.

Outdoor unit

Component	Starting	Running	Ending
Compressor	Normal control	Setting value	Normal control
Fan	Normal control	Off	Normal control
EEV (Thermo on)	Normal control	Setting value	Normal control
EEV (Thermo off)	Min. Pulse	Setting value	Min. Pulse
4 way valve	On	Off	On

Indoor unit

Component	Starting	Running	Ending
Fan	Normal control	Off	Normal control
Defrost signal	Off	On	Off

5. Defrost control

Defrost operation eliminates ice accumulated on heat exchanger, recovering performance of heat exchanger. Each cycle component operates as shown on the below table during defrost operation.

Outdoor unit

Component	Starting	Running	Ending
Compressor	Normal control	Setting value	Normal control
Fan	Normal control	Off	Normal control
EEV (Thermo on)	Normal control	Setting value	Normal control
EEV (Thermo off)	Min. Pulse	Setting value	Min. Pulse
4 way valve	On	Off	On

Indoor unit

Component	Starting	Running	Ending
Fan	Normal control	Off	Normal control
Oil return signal	Off	On	Off

6. Protection control

6.1 High pressure protection control

Pressure range	Compressor
$P_d \geq 4069 \text{ kPa}$	Off
$3938 \text{ kPa} \leq P_d < 4069 \text{ kPa}$	3Hz down
$3840 \text{ kPa} \leq P_d < 3938 \text{ kPa}$	3Hz down
$3709 \text{ kPa} \leq P_d < 3840 \text{ kPa}$	Frequency holding
$3611 \text{ kPa} \leq P_d < 3709 \text{ kPa}$	3 Hz up
$P_d < 3611 \text{ kPa}$	Normal control

* 14,16k models are not applied.

6.2 Low pressure protection control

■ Cooling Mode

Pressure range	Compressor
$P_e > 310 \text{ kPa}$	Normal control
$278 \text{ kPa} < P_e \leq 310 \text{ kPa}$	3Hz down
$245 \text{ kPa} < P_e \leq 278 \text{ kPa}$	3Hz down
$212 \text{ kPa} < P_e \leq 245 \text{ kPa}$	3Hz down
$P_e \leq 212 \text{ kPa}$	Off

* 14,16k models are not applied.

■ Heating mode

Pressure range	Compressor
$P_e > 294 \text{ kPa}$	Normal control
$255 \text{ kPa} < P_e \leq 294 \text{ kPa}$	3Hz down
$229 \text{ kPa} < P_e \leq 255 \text{ kPa}$	3Hz down
$203 \text{ kPa} < P_e \leq 229 \text{ kPa}$	3Hz down
$P_e \leq 203 \text{ kPa}$	Off

* 14,16k models are not applied.

6.3 Discharge temperature control

Temperature range	Compressor
$T_d \geq 105 \text{ }^\circ\text{C}$	Off
$100^\circ\text{C} \leq T_d < 105^\circ\text{C}$	5Hz down
$95^\circ\text{C} \leq T_d < 100^\circ\text{C}$	5Hz down
$93^\circ\text{C} \leq T_d < 95^\circ\text{C}$	Frequency holding
$90^\circ\text{C} \leq T_d < 93^\circ\text{C}$	3 Hz up
$T_d < 90^\circ\text{C}$	Normal control

6.4 Input Current control

	Normal control	Frequency down	Comp off
Input current	Less than 10A	14A or less	Over than 14A

* **Remarks:** The data of pressure and frequency are different model by model.

Part 4. Test Run

1. Check before Test Run.....	34
2. Test Run Flow chart	35
3. Test Running.....	36

1. Check before Test Run

1	Check to see whether there is any refrigerant leakage, and check whether the power or transmission cable is connected properly.
2	Check liquid pipe and gas pipe valves are fully opened. NOTE: Be sure to tighten caps.
3	Confirm that 500 V megger shows 2.0 MΩ or more between power supply terminal block and ground. Do not operate in the case of 2.0 MΩ or less. NOTE: Never carry out mega ohm check over terminal control board. Otherwise the control board may break. Immediately after mounting the unit or after leaving it turned off for an extended length of time, the resistance of the insulation between the power supply terminal board and the ground may decrease to approx. 2.0 MΩ as a result of refrigerant accumulation in the internal compressor. If the insulation resistance is less than 2.0 MΩ, turn on the main power supply.

2. Test Run Flow chart

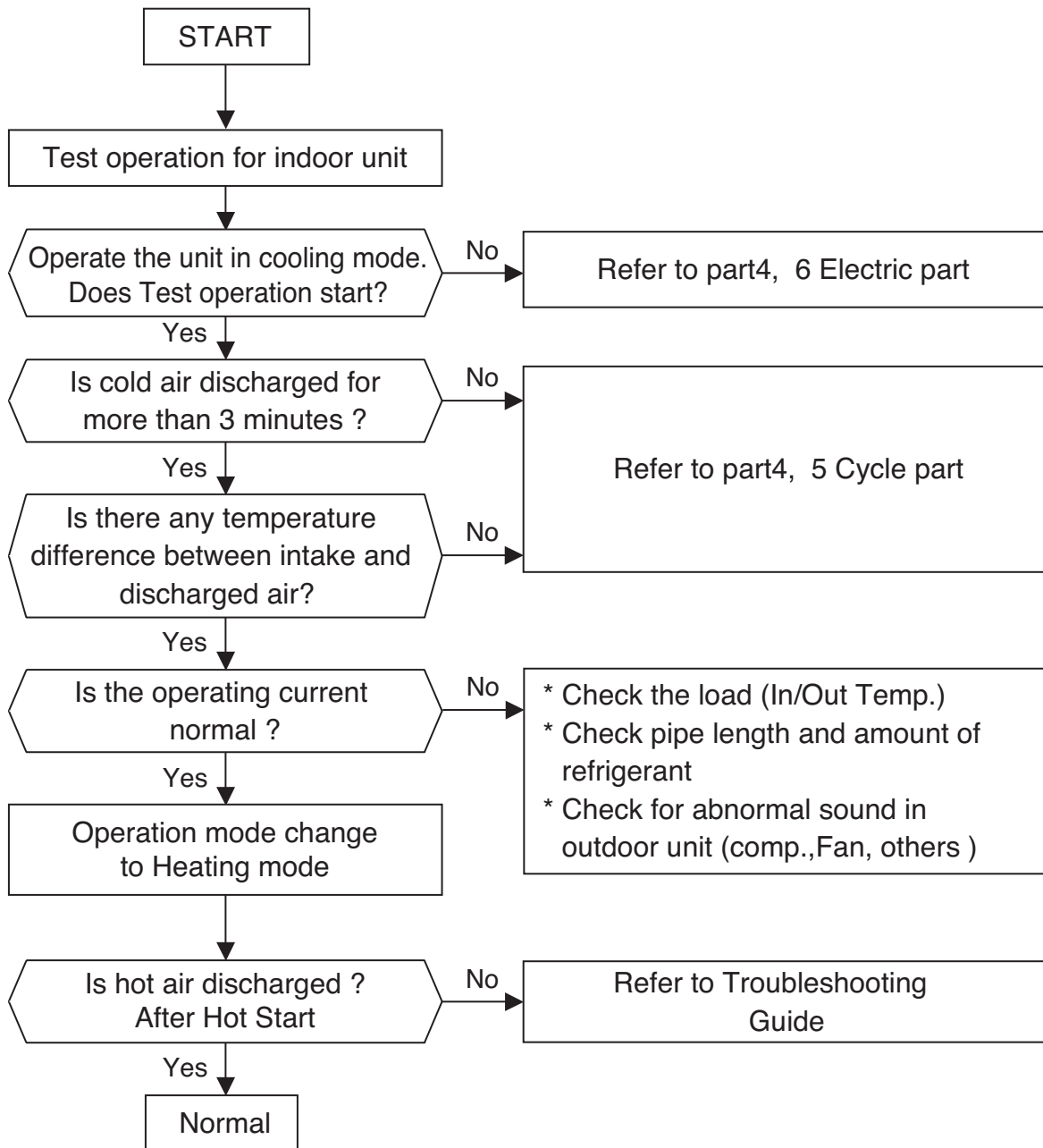

- Each indoor unit should be tested.
- If the unit has accessory, it should be tested.

3. Test Running

3.1 SPLIT, ART cool, ART cool deluxe Type

- Check that all tubing and wiring have been properly connected.
- Check that the gas and liquid side service valves are fully open.

3.1.1 Prepare remote controller

- 1 Remove the battery cover by pulling it according to the arrow direction.
- 2 Insert new batteries making sure that the (+) and (-) of battery are installed correctly.
- 3 Reattach the cover by pushing it back into position.

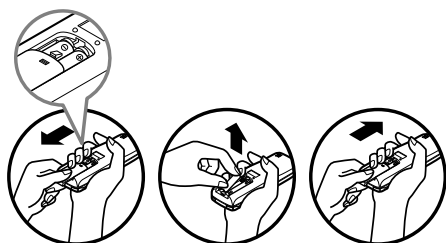

NOTE:

- Use 2 AAA(1.5volt) batteries. Do not use rechargeable batteries.
- Remove the batteries from the remote controller if the system is not going to be used for a long time.

3.1.2 Precautions in test run

- The initial power supply must provide at least 90% of the rated voltage. Otherwise, the air conditioner should not be operated.
- For test run, carry out the cooling operation firstly even during heating season. If heating operation is carried out firstly, it leads to the trouble of compressor. Then attention must be paid.
- Carry out the test run more than 5 minutes without fail. (Test run will be cancelled 18 minutes later automatically)
- The forced operation is started by pressing button for 2 seconds. The test run is started by pressing button for 3~6 seconds.
- To cancel the test run, press any button.

3.1.3 Settlement of outdoor unit

- Anchor the outdoor unit with a bolt and nut(ø10mm) tightly and horizontally on a concrete or rigid mount.
- When installing on the wall, roof or rooftop, anchor the mounting base securely with a nail or wire assuming the influence of wind and earthquake.
- In the case when the vibration of the unit is conveyed to the hose, secure the unit with an anti-vibration rubber.

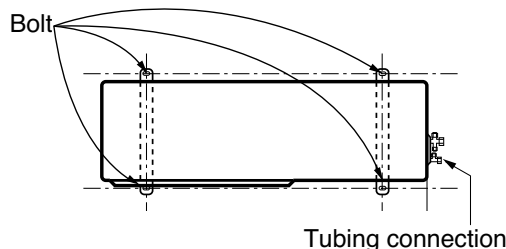

3.1.4 Evaluation of the performance

Operate unit for 15~20 minutes, then check the system refrigerant charge:

1. Measure the pressure of the gas side service valve.
2. Measure the temperature of the intake and discharge of air.
3. Ensure the difference between the intake temperature and the discharge is more than 8°C (Cooling) or reversely (Heating).

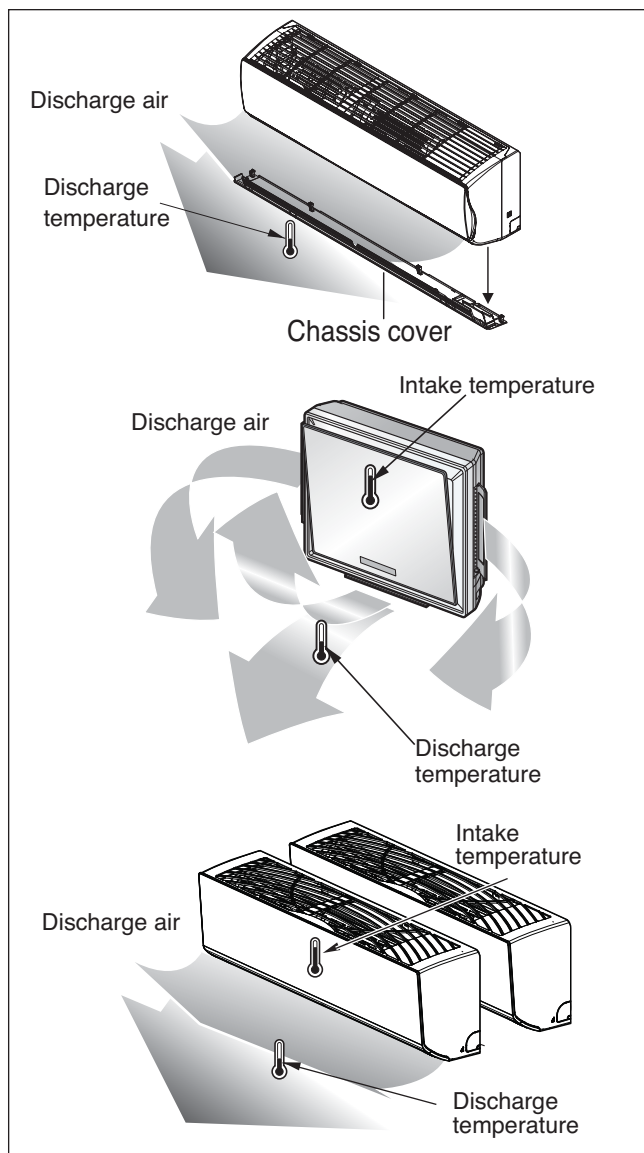

3.2 Ceiling Cassette Type

3.2.1 PRECAUTIONS IN TEST RUN

- The initial power supply must provide at least 90% of the rated voltage. Otherwise, the air conditioner should not be operated.

CAUTION:

- ① For test run, carry out the cooling operation first even during winter season. If heating operation is carried out first, it leads to the trouble of compressor.
 - ② Carry out the test run more than 5 minutes without stopping.
(Test run will be cancelled 18 minutes later automatically)
- The test run is started by pressing the room temperature checking button and down timer button for 3 seconds at the same time.
 - To cancel the test run, press any button.

3.2.2 CHECK THE FOLLOWING ITEMS WHEN INSTALLATION IS COMPLETE

- After completing work, be sure to measure and record trial run properties, and store measured data, etc.
- Measuring data are room temperature, outside temperature, suction temperature, blow out temperature, air velocity, air volume, voltage, current, presence of abnormal vibration and noise, operating pressure, piping temperature.
 - As to the structure and appearance, check following items.

- | | |
|---|--|
| <input type="checkbox"/> Is the circulation of air adequate? | <input type="checkbox"/> Does the remote controller work properly? |
| <input type="checkbox"/> Is the drainage OK? | <input type="checkbox"/> Is there any error on wiring? |
| <input type="checkbox"/> Is the heat insulation complete
(refrigerant and drain piping)? | <input type="checkbox"/> Aren't terminal screws loosened? |
| <input type="checkbox"/> Is there any leakage of refrigerant? | |

M4.....118N.cm{12kgf.cm} M5.....196N.cm{20kgf.cm}
M6.....245N.cm{25kgf.cm} M8.....588N.cm{60kgf.cm}

Part 5. Trouble Shooting

1. Self-diagnosis Function	39
1.1 Error Indicator (Indoor).....	39
1.2 Error Indicator (Outdoor).....	40
2. Pump Down	41
3. Evacuation	42
4. Gas Charging	43
5. Cycle Part	44
6. Electronic Parts	45
6.1 The Product doesn't operate at all.....	45
6.2 The Product doesn't operate with the remote controller	46
6.3 The Compressor/Outdoor Fan are don't operate	47
6.4 When indoor Fan does not operate.....	48
6.5 When the louver does not operate.....	49
6.6 Troubleshooting Indoor Error	50
6.7 Troubleshooting Outdoor Error	56

1. Self-diagnosis Function

1.1 Error Indicator (Indoor)

Ceiling Cassette Type Display

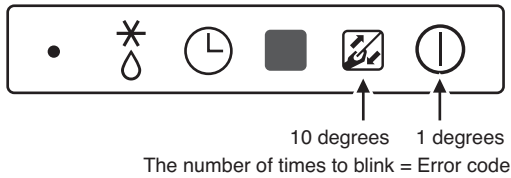

Standard Libero Type Display

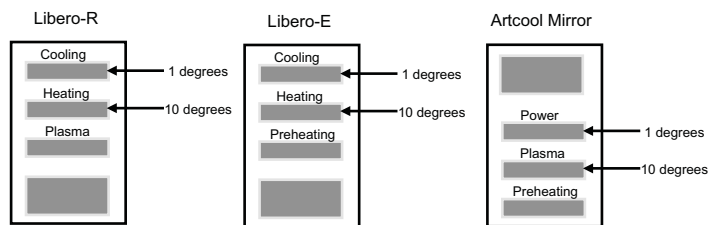

Error Indicator

- The function is to self-diagnosis airconditioner and express the troubles identifiably if there is any trouble.
- Error mark is ON/OFF for the operation LED of evaporator body in the same manner as the following table.
- If more than two troubles occur simultaneously, primarily the highest trouble fo error code is expressed.
- After error occurrence, if error is released, error LED is also released simultaneously.
- To operate again on the occurrence of error code, be sure to turn off the power and then turn on.
- Having or not of error code is different from Model.

Indoor Error

Error code	Description	Indoor Status
00	No Error	ON
01	Indoor Room themistor error	OFF
02	Indoor in-piping sensor error	OFF
03	Remote controller error	OFF
04	Drain Pump error	OFF
05	Communcation error between in and out	OFF
06	Indoor Out-Piping sensor error	OFF
07	Differnt mode operation	OFF
09	EEPROM Check Sum Error	OFF
10	Indoor BLDC Fan Lock	OFF

1.3 Error Indicator (Outdoor)

Outdoor Error

Ex) Error 21 (DC Peack)

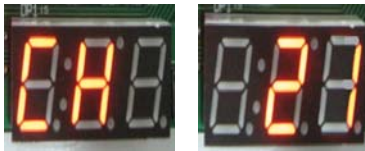
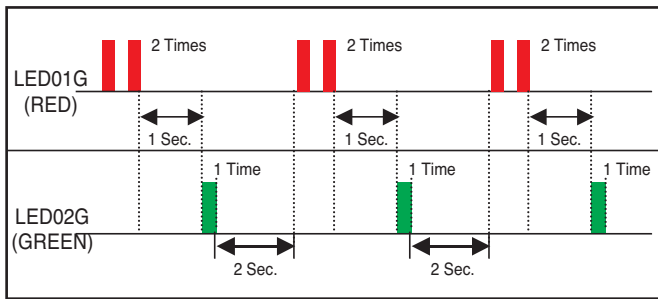

Error Code	Contents	LED01G/M (Red)	LED02G/M (Green)	case of Error	Outdoor Status
21	DC Link Peak (IPM Fault)	2times ●	1times ●	Over Rated Current	Off
22	CT 2 (Max CT)	2times ●	2times ●	Input Over Current	Off
23	DC Link Low Volt.	2times ●	3times ●	DC Link Volt is below 140Vdc	Off
	DC Link High Volt.			DC Link Volt is above 420Vdc	
25	Low Voltage/Over Voltage	2times ●	5times ●	Abnormal AC Volt Input	Off
26	DC Compressor Position Error	2times ●	6times ●	Compressor Starting Fall Error	Off
27	PSC/PFC Fault Error	2times ●	7times ●	Over Inverter PCB input current	Off
29	COMP Over Current	2times ●	9times ●	Over Inverter Compressor Current	Off
32	D-Pipe High	3times ●	2times ●	D-Pipe Temp. High	Off
35	Low Pressure Error	3times ●	5times ●	Excessive decrease of Low Pressure	Off
39	Communication Error	3times ●	9times ●	Communication Error Between PFC Micom and INV Micom	Off
40	CT Sensor (Open/Short)	4times ●	○	CT Circuit Malfunction	Off
41	INV. D-Pipe Th Error	4times ●	1times ●	Open/Short	Off
43	High Pressure Sensor Error	4times ●	3times ●	Open/Short	Off
44	Outdoor Air Th Error	4times ●	4times ●	Open/Short	Off
45	Cond. Mid-Pipe Th Error	4times ●	5times ●	Open/Short	Off
46	Suction Pipe Th Error	4times ●	6times ●	Open/Short	Off
48	Cond. Out-Pipe Th Error	4times ●	8times ●	Open/Short	Off
51	Capacity Over	5times ●	1times ●	Over combination	Off
53	Signal Error (Indoor <-> Outdoor)	5times ●	3times ●	Communication Poorly	Off
54	3-Phase Wrong wiring	5times ●	4times ●	3-Phase Wrong Wring of Outdoor Unit (Reverse Phase/Omission of Phase)	Off
60	EEPROM Check Sum Error	6times ●	○	Check Sum Mismatching	Off
61	Cond. Pipe Th High	6times ●	1times ●	Cond. Temp. High	Off
62	Heaksink Th High	6times ●	2times ●	Heatsink Temp. High	Off
65	Heaksink Th Error	6times ●	5times ●	Open/Short	Off
67	Outdoor BLDC Fan Lock	6times ●	7times ●	Outdoor Fan is not operation	Off
73	PFC Fault Error(S/W)	7times ●	3times ●	Over Current of Outdoor Unit PFC	Off

● : A light on the display panel is blink.

2. Pump Down

This function gathers the refrigerant present in the system to ODU
Use this function to store refrigerant of system in ODU for leakage or IDU replacement.

• Procedure

■ This function start Dip switch setting status of ODU PCB.

(1) Set the Dip switch as follow after shutting the power source down.

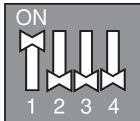

(2) Reset the power.

(3) Check that the Red LED of PCB is on during work.(The indoor unit is operated by force.)

(4) Pump down during forced cooling operation.

CAUTION

1. Use pump down function within guaranteed temperature range
IDU : 20~32C
ODU : 0~40C
2. Make certain that IDU doesn't run with thermo off mode during operation
3. After the compressor is starting operation, please complete Pump Down within 4 minutes.
4. Pump Down can be stopped (The compressor is turned off), because of compressor protection.
In this case, reset the power.

3. Evacuation (All amount of refrigerant leaked)

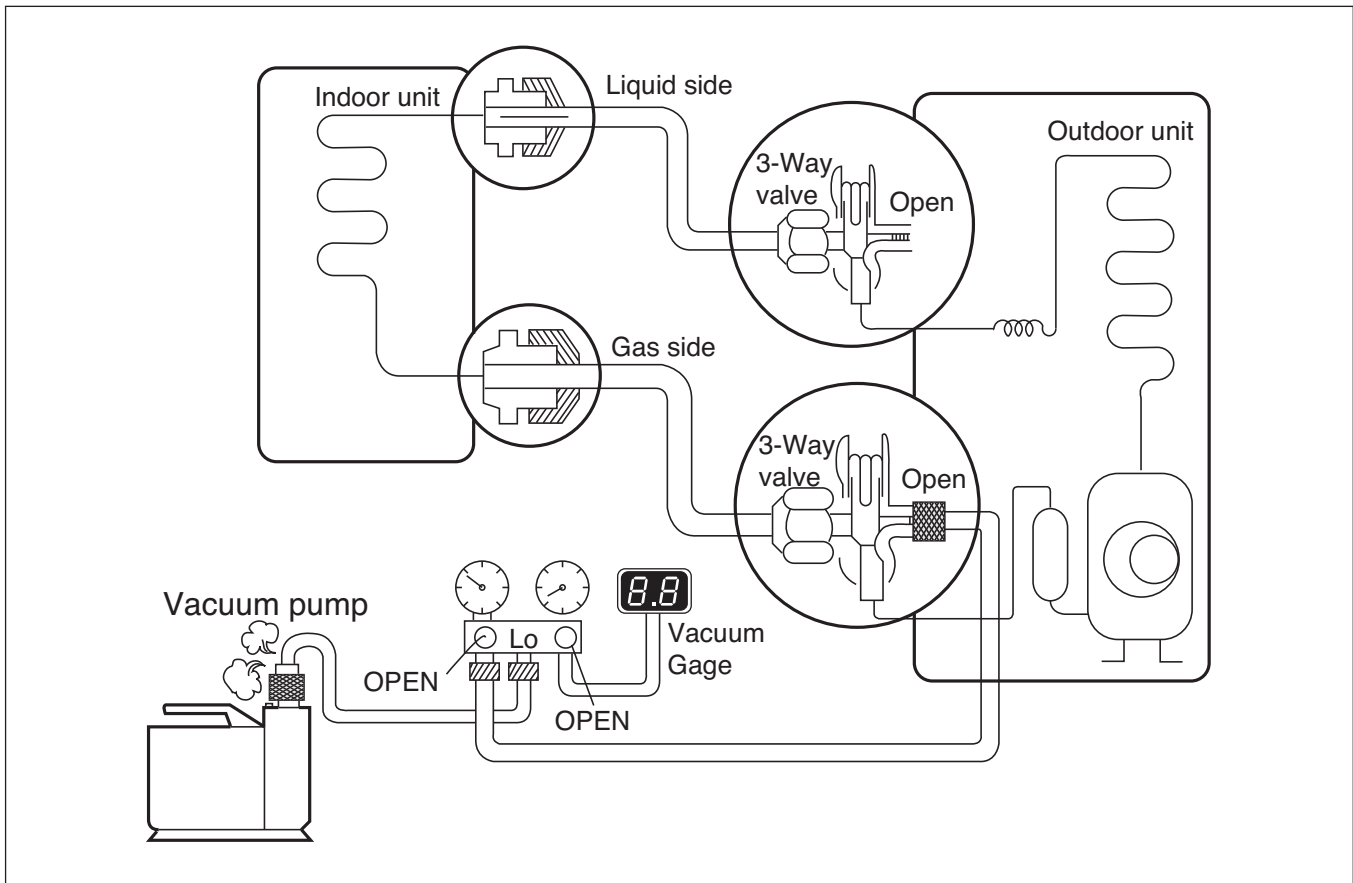

• Procedure

- (1) Connect the vacuum pump to the center hose of charge set center hose
- (2) Evacuation for approximately one hour.
 - Confirm that the gauge needle has moved toward 0.8Torr.
- (3) Close the valve (Lo side) on the charge set, turn off the vacuum pump, and confirm that the gauge needle does not move (approximately 5 minutes after turning off the vacuum pump).

- (4) Disconnect the charge hose from the vacuum pump.
 - Vacuum pump oil.
 - If the vacuum pump oil becomes dirty or depleted, replenish as needed.

! WARNING

Use a vacuum pump or Inert (nitrogen) gas when doing leakage test or air purge. Do not compress air or Oxygen and do not use Flammable gases. Otherwise, it may cause fire or explosion.

- Otherwise, it may cause personal injury.

4. Gas Charging (After Evacuation)

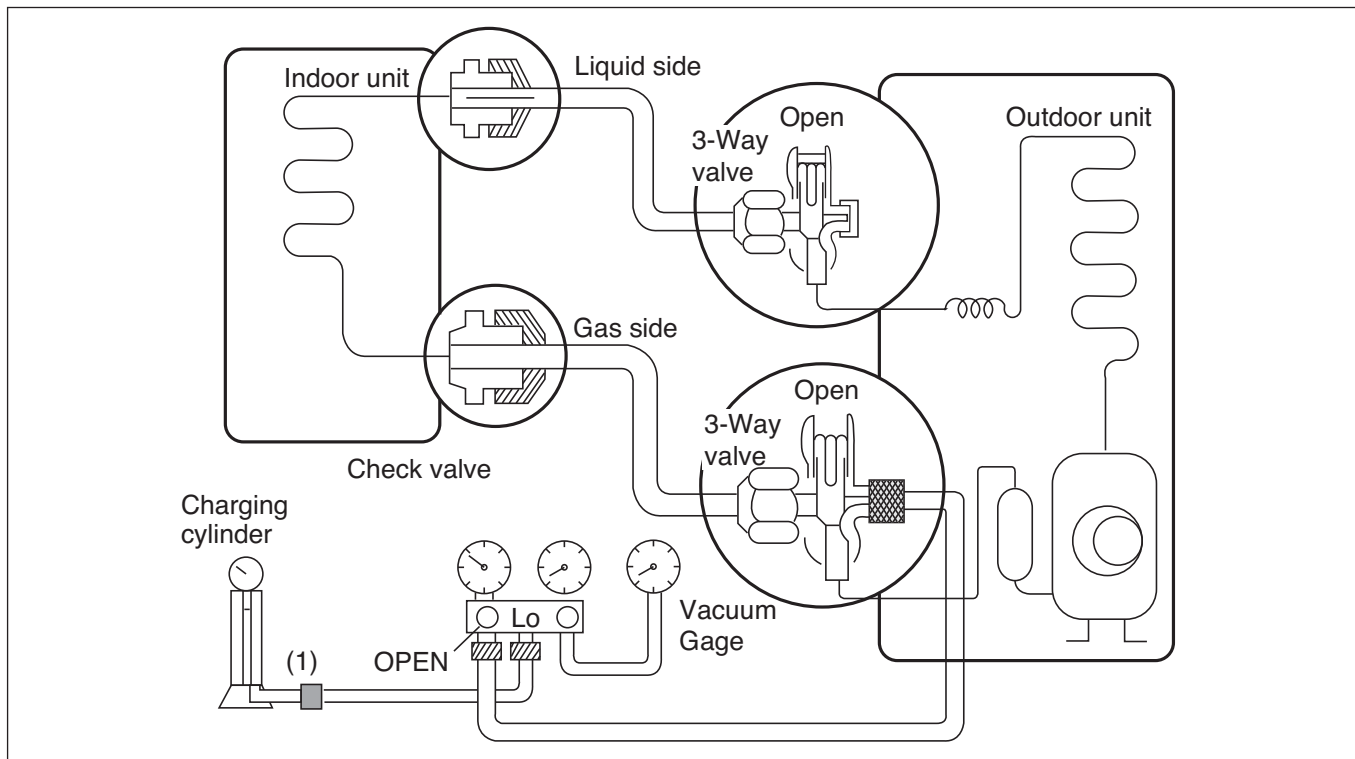

• Procedure

(1) Connect the charge hose to the charging cylinder.

- Connect the charge hose which you disconnected from the vacuum pump to the valve at the bottom of the cylinder.
- If you are using a gas cylinder, also use a scale and reverse the cylinder so that the system can be charged with liquid.

(2) Purge the air from the charge hose.

- Open the valve at the bottom of the cylinder and press the check valve on the charge set to purge the air. (Be careful of the liquid refrigerant). The procedure is the same if using a gas cylinder.

(3) Open the valve (Lo side on the charge set and charge the system with liquid refrigerant.

- If the system can not be charged with the specified amount of refrigerant, it can be charged with a little at a time (approximately 150g each time) while operating the air conditioner in the cooling cycle; however, one time is not sufficient, wait approximately 1 minute and then repeat the procedure (pumping down-pin).

This is different from previous procedures. Because you are charging with liquid refrigerant from the gas side, absolutely do not attempt to charge with larger amounts of liquid refrigerant while operating the air conditioner.

(4) Immediately disconnect the charge hose from the 3-way valve's service port.

- Stopping partway will allow the gas to be discharged.
- If the system has been charged with liquid refrigerant while operating the air conditioner turn off the air conditioner before disconnecting the hose.

(5) Mount the valve stem nuts and the service port nut.

- Use torque wrench to tighten the service port nut to a torque of 1.8 kg.m.
- Be sure to check for gas leakage.

! WARNING

When installing or relocation the unit, make sure that no substance other than the specified refrigerant(R410A) enter the refrigerant circuit.

- Any presence of foreign substance such as air can cause an abnormal pressure rise and may result in explosion or injury.

5. Cycle Part

Trouble analysis

1. Check temperature difference between intake and discharge air, and check for the operating current too.

Case	Symptom	Supposed Caused
Case 1	Temp. difference : approx. 0°C Current : less than 80% of rated current	All amount of refrigerant leaked out. Check refrigeration cycle.
Case 2	Temp. difference : approx. 8°C Current : less than 80% of rated current	Refrigerant leakage Clog of refrigeration cycle Defective Compressor.
Case 3	Temp. difference : less than 8°C Current : over the rated current	Excessive amount of refrigerant
Case 4	Temp. difference : over 8°C	Normal

NOTICE

Temperature difference between intake and discharge air depends on room air humidity. When the room air humidity is relatively higher, temperature difference is smaller. When the room air humidity is relatively lower temperature difference is larger.

2. Check temperature and pressure of refrigeration cycle in cooling mode.

Suction pressure (Compared with the normal value)	Temperature of Discharge Air (Compared with the normal valve)	Cause of Trouble	Description
Higher	High	Defective compressor Defective 4-way reverse valve	Current is low.
	Normal	Excessive amount of refrigerant	High pressure does not quickly rise at the beginning of operation.
Lower	Higher	Insufficient amount of refrigerant (Leakage) Clogging	Current is low.

NOTICE

1. The suction pressure is usually 8.5~9.5kg/cm²G(Cooling) at normal condition.(R410A)
2. The temperature can be measured by attaching the thermometer to the low pressure tubing and wrap it with putty.

6. Electronic Parts

6.1 The Product doesn't operate at all

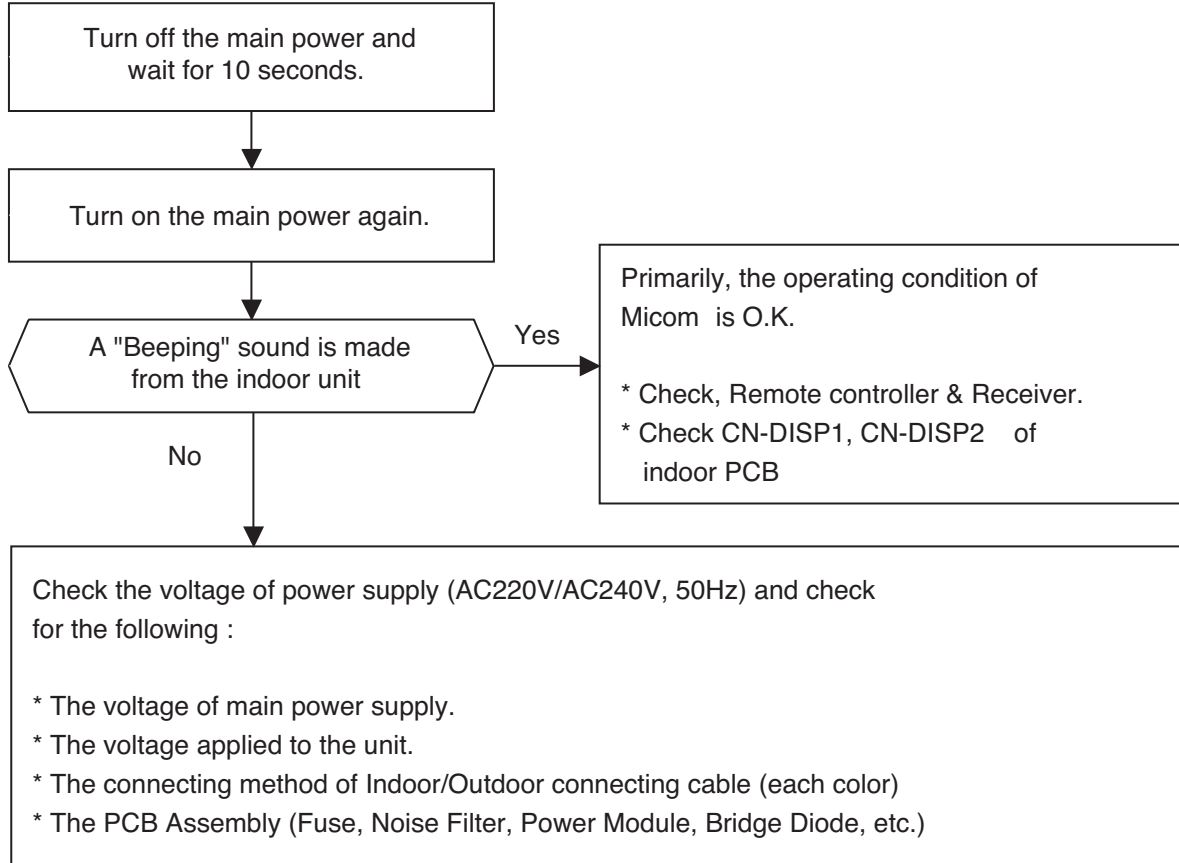

The operation check of the Indoor PCB Assembly		
Procedure	Specification	Remedy
1) The input voltage of power module.	1) AC230V ± 30V : Check the rated voltage	1) Check the power outlet.
2) The output voltage of power module.	2) 12V ± 3V	2) Replace PCB Assembly
4) IC04D(7805)	4) DC5V	4) Replace PCB Assembly
5) IC01A(KIA7036)	5) The voltage of micom pin 19 : DC4.5V↑	5) Replace PCB Assembly

6.2 The Product doesn't operate with the remote controller

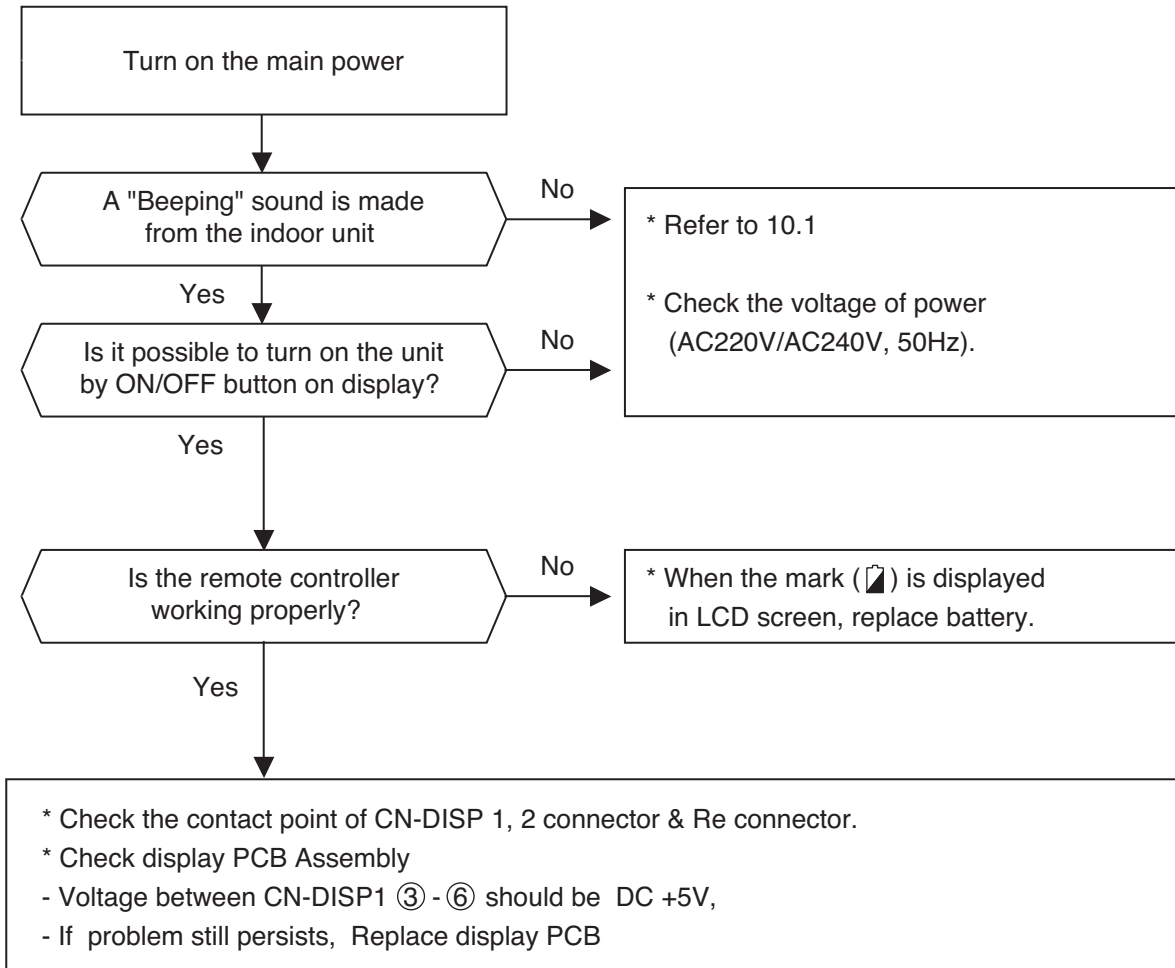

6.3 The Compressor/Outdoor Fan are don't operate

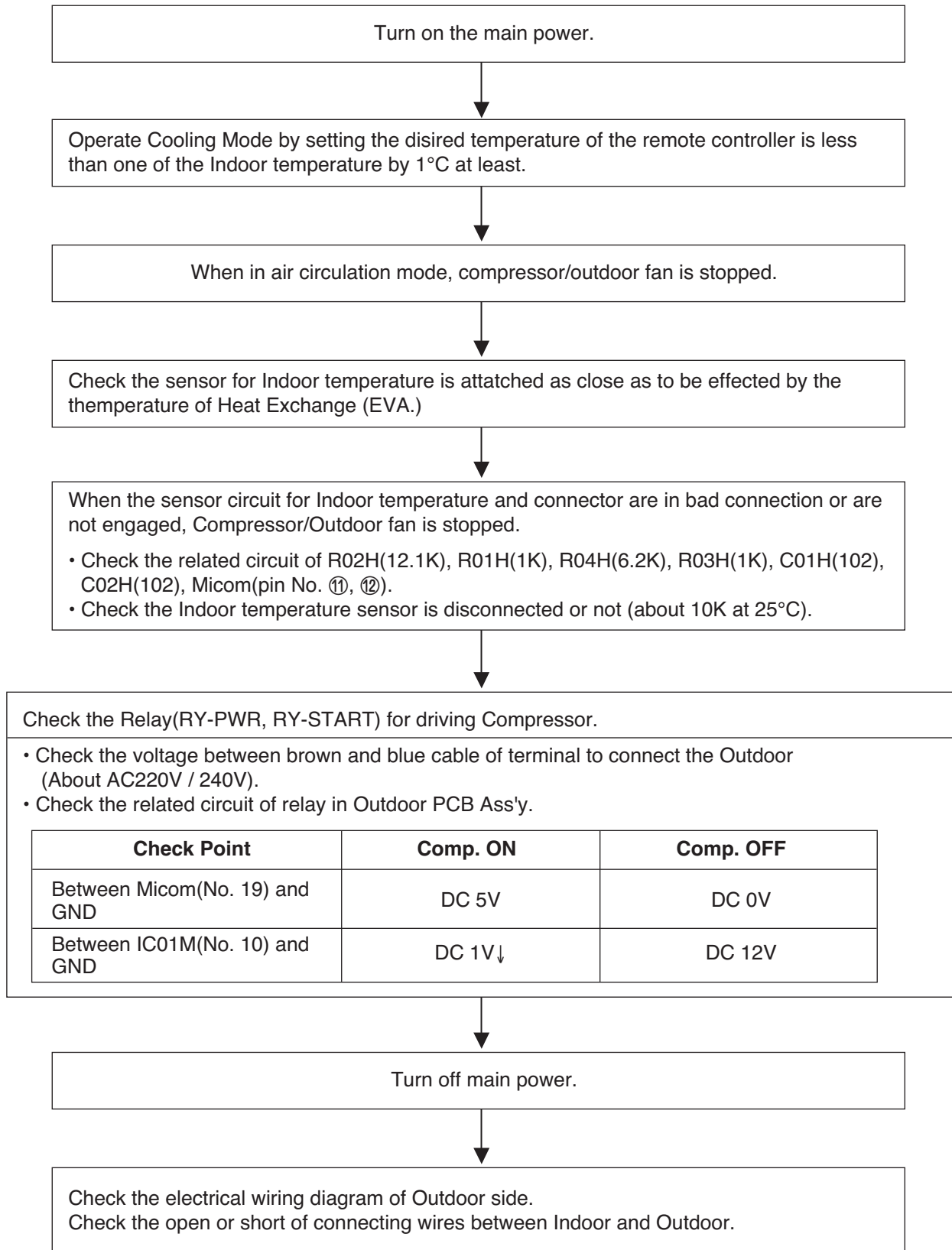

6.4 When indoor Fan does not operate.

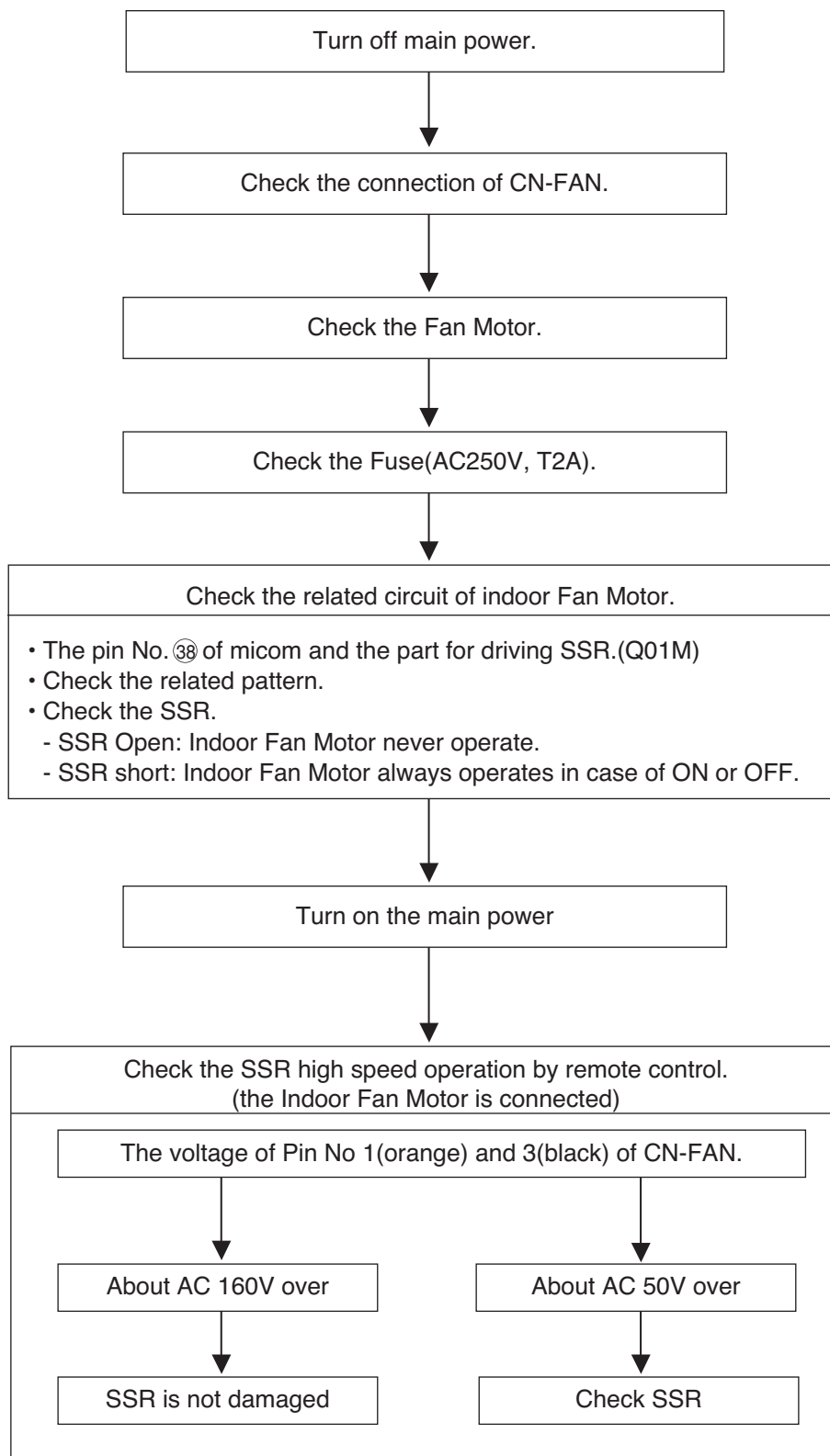

6.5 When the louver does not operate.

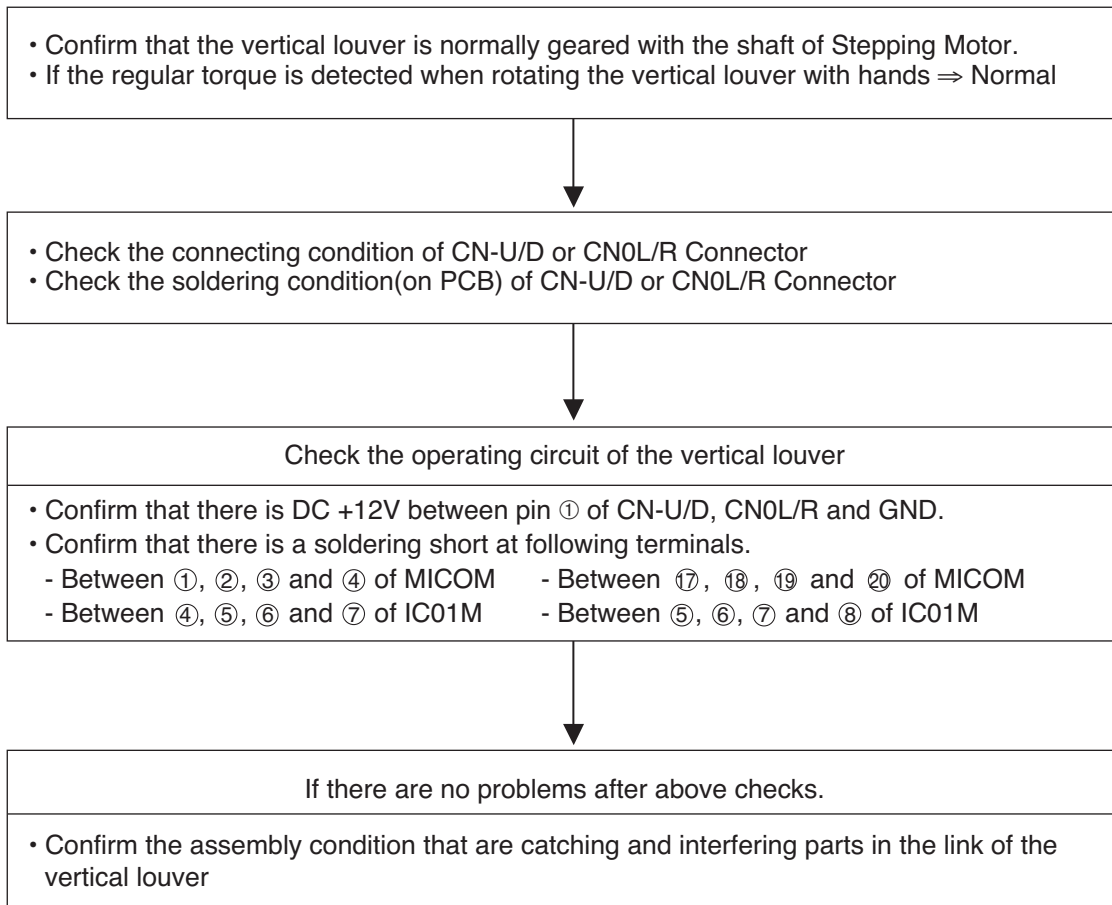

6.6 Troubleshooting Indoor Error

Display code	Title	Cause of error	Check point & Normal condition
01	Indoor air sensor	<ul style="list-style-type: none"> • Open / Short • Soldered poorly • Internal circuit error 	Normal resistor : 10K Ω / at 25°C (Unplugged) Normal voltage : DC 2.5V / at 25°C (plugged)
02	Indoor inlet pipe sensor	<ul style="list-style-type: none"> • Open / Short • Soldered poorly • Internal circuit error 	Normal resistor : 5K Ω / at 25°C (Unplugged) Normal voltage : DC 2.5V / at 25°C (plugged)
06	Indoor outlet pipe sensor	<ul style="list-style-type: none"> • Open / Short • Soldered poorly • Internal circuit error 	Normal resistor : 5K Ω / at 25°C (Unplugged) Normal voltage : DC 2.5V / at 25°C (plugged)

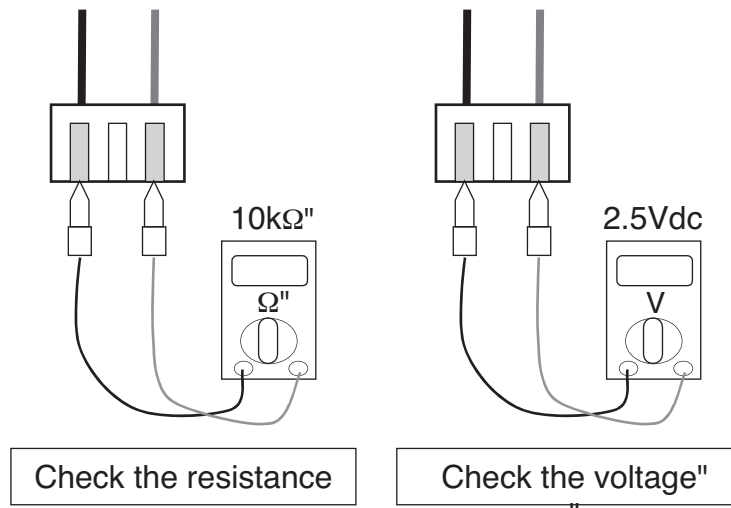

Check Point

1. Unplug the sensor on Indoor unit PCB.
2. Estimate the resistance of each sensor.
3. If the resistance of the sensor is 10K Ω / 5K Ω at 25°C, then sensor is normal.
4. If the resistance of the sensor is 0 K Ω or ∞ , then sensor is abnormal. → Change the sensor.
5. Plug the sensor on Indoor unit PCB and Power ON.
6. Estimate the voltage of each sensor.
7. If the voltage of the sensor is 2.5Vdc at 25°C, then sensor is normal.
8. If the resistance of the sensor is 0 or 5Vdc, then sensor is abnormal. → Repair or Change the PCB.

Display code	Title	Cause of error	Check point & Normal condition
03	Communication Wired R/C	<ul style="list-style-type: none"> • Open / Short • Wrong connection 	<ul style="list-style-type: none"> • Connection of wire • Main PCB Volt. DC12V • Noise interference

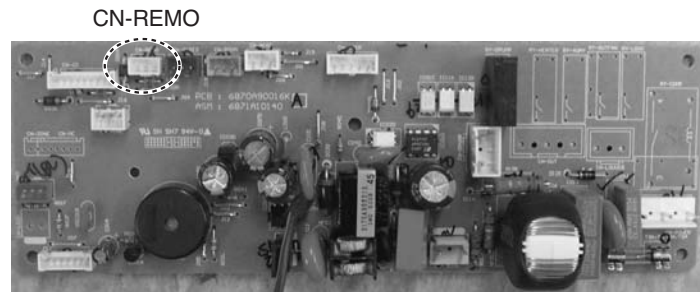
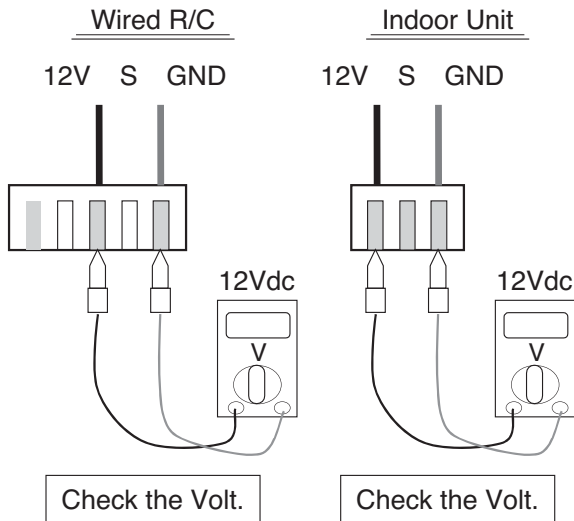

Check Point

1. Check the wire connection. (Open / Short) → Repair the connection
2. Check the soldering state of connector. (Soldered poorly) → Repair or Change the PCB.
3. Check the volt. Of main PCB power source. (DC 12V) → Repair or Change the main PCB.
4. Check the installation of wired remote controller. (Noise interference) → Adjust the state of installation

Part 5. Trouble Shooting

Display code	Title	Cause of error	Check point & Normal condition
04	Drain pump / Float switch	<ul style="list-style-type: none"> • Float switch Open. (Normal : short) 	<ul style="list-style-type: none"> • The connection of wire(Drain pump/ Float switch) • Drain pump power input. (230V) • Drain tube installation. • Indoor unit installation. (Inclination)

CN Float

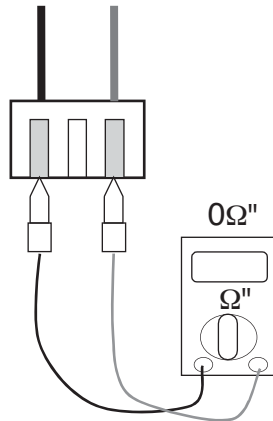

Check the resistance

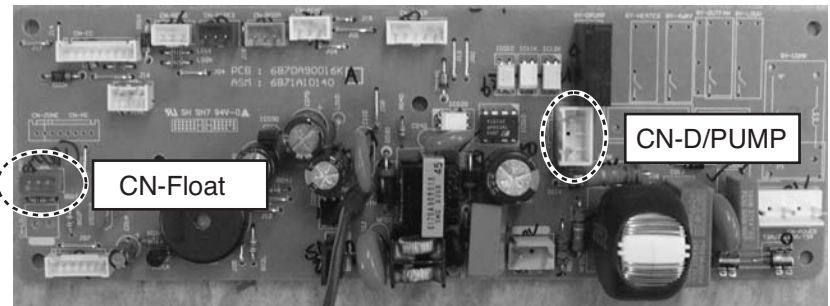

Check Point

1. Check the wire connection. (Open, Soldered poorly) → Repair the connection or change the PCB.
2. Check the resistance of float switch (Abnormal : Open, Normal : short) → Check the float switch.
3. Check the level of water
4. Check the volt. Of Drain pump power supply. (AC 230V) → Repair or Change the main PCB.

Display code	Title	Cause of error	Check point & Normal condition
07	Different Operation Mode	<ul style="list-style-type: none"> One of Indoor Unit operate cooling Another Unit operate heating 	<ul style="list-style-type: none"> At the same time, this model cannot use cool and heating mode

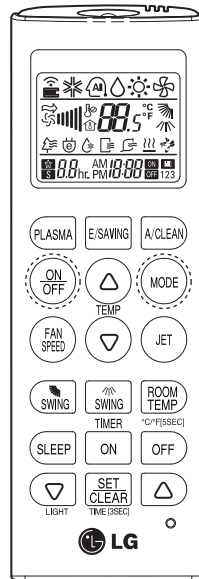

Check Point

1. Check another indoor model operation mode
2. Operating the same mode with the first operated indoor unit
3. Clearing the "CH07"
Press the on/off button or mode change button and matching the indoor unit mode same as the first operated indoor unit

Display code	Title	Cause of error	Check point & Normal condition
09	Indoor EEPROM Check Sum Error	• Check sum error	1. Check the poor soldering 2. Check the insertion condition of the EEPROM 3. Check the PCB Connection

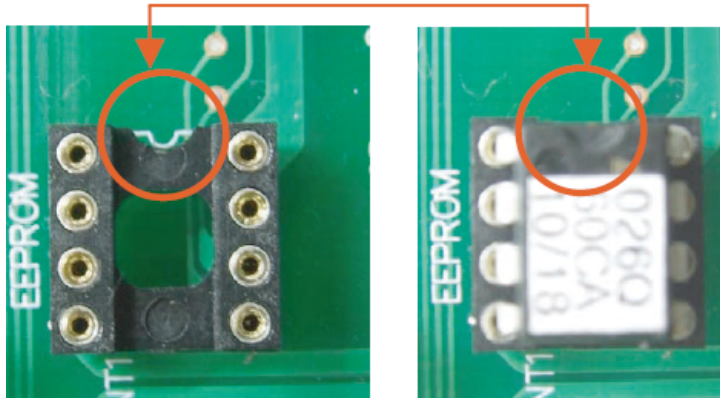

<EEPROM Direction Check Point>

Check Point

1. Check the EEPROM Direction
2. If the EEPROM value & the Program value are not matched, the Code is Displayed
3. After Checking the connection and Insertion, replace the PCB or Option PCB

Display code	Title	Cause of error	Check point & Normal condition
10	Indoor BLDC Fan Motor Lock	The Fan is not operated properly	Check the Indoor fan locking

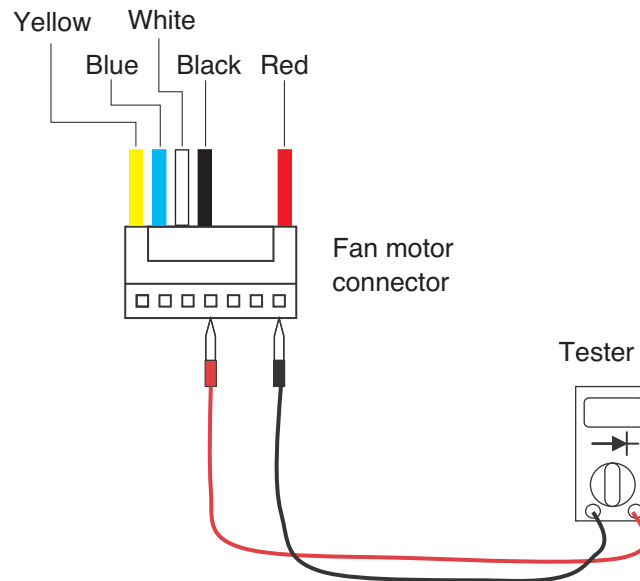

Check Point

Check the PCB during the Power on

1. Check the Voltage Red line to Black line
 - The Voltage is about [input voltage x 1.414]
 - if the Voltage does not come with the above Voltage,
 - Check the power input
 - Replace the PCB & Motor
2. Check the Voltage Black line to White
 - the Voltage is DC 15V
 - Check the Power input
 - Replace the motor

Check the Motor

1. Check the shaft
 - if the shaft is not turn smoothly, the Motor Power IC is defected
 - replace the motor
2. Check the motor resistance(if the shaft is turn smoothly, check the resistance)
 - Check Red line to Black line, Blue line to Black line
 - The resistance should infinite
 - replace the motor

6.7 Troubleshooting Outdoor Error

▶ A2UW18GFA0/A3UW24GFA0

Display code	Title	Cause of error	Check point & Normal condition
21	High current into the compressor	<ul style="list-style-type: none"> Compressor blocked Disconnection/shortcircuit inside compressor Over load operation (Outdoor fan constraint, screened, blocked) Burned parts inside PCB 	<ul style="list-style-type: none"> Check compressor constraint Check compressor wire open/short Check compressor insulation damage Check outdoor fan constraint / screened / flow structure Check if IPM burned

warning

Before checking PCB or each outdoor electric parts, wait for 3 minutes after the power is off. When measuring at standby state of power supply, after checking the measurement mode of the meter, be careful of the short-circuits with other parts.

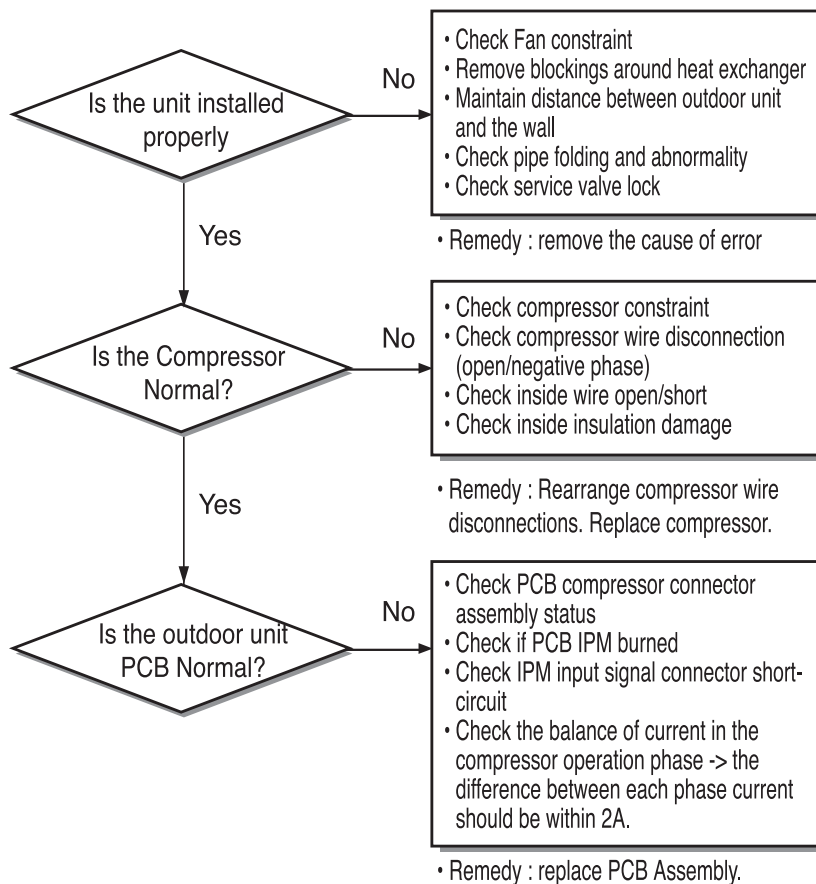

• Check for short-circuit of PCB IPM Input Signal Connector.

1. Set as the multi-tester resistance measurement mode.
2. Check the short-circuit between the input signal pins at the IPM(SPM3) lower parts in Power-off state.

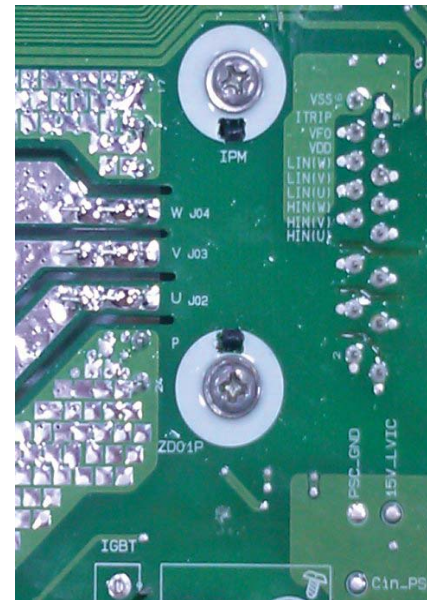

• Verifying compressor burn

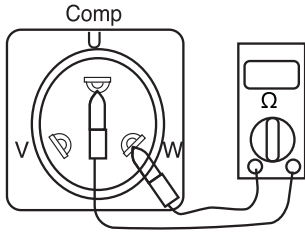

1. Remove the connectors to the PCB.
2. Measure the resistance between the lines of each terminal of the compressor. (Refer to Table 1)
3. Measure the resistance between each terminal and the chassis(pipe) of the compressor. (Refer to Table 2)
4. If the measurements are distinctively different from Table 1 and 2, the compressor is decided to be burned.

Table 1

Model	Resistance(Ω)	
	Terminal	Inverter Comp.
18/24k	U-V	1.125(at25°C)
	V-W	1.125(at25°C)
	W-U	1.125(at25°C)

Table 1

Resistance of terminal insulations)	
U - chassis	1M Ω ↑
V - chassis	1M Ω ↑
W - chassis	1M Ω ↑

• Verifying IPM burn

1. Remove the connectors to the PCB.
2. Set Multi-tester as Diode voltage measurement mode.
3. Measure voltages of P~U / P~V / P~W as shown in figure 1 below.
4. Measure voltages of U~Nu / V~Nu / W~Nu as shown in figure 2 below.
5. If the measurements are distinctively different as in the figures, the IPM is decided to be burned.

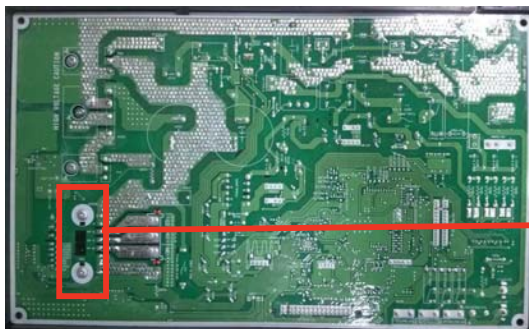

[IPM Position & Pin number]

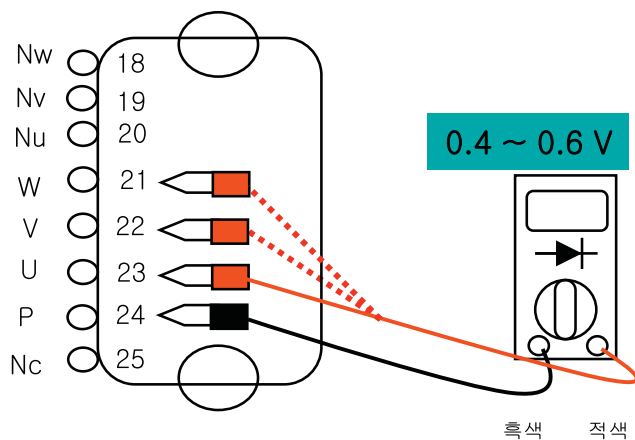
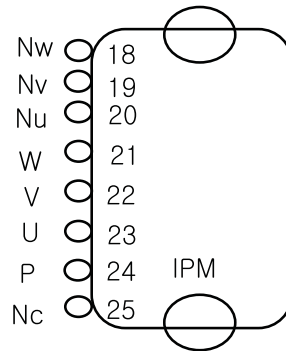

[Figure 1]

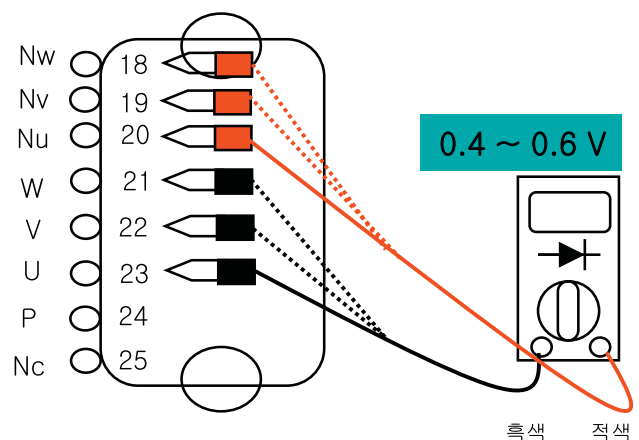

[Figure 2]

Display code	Title	Cause of error	Check point & Normal condition
22	AC Input current is higher than the limit.	<ul style="list-style-type: none"> • Input voltage error(low voltage) • Over load operation (Outdoor fan constraint, screened, blocked) • Burned parts inside PCB 	<ul style="list-style-type: none"> • Check input voltage • Check outdoor fan constraint / screened / flow structure • Check PCB current sensor parts

! WARNING

Before checking PCB or each outdoor electric parts, wait for 3 minutes after the power is off. When measuring at standby state of power supply, after checking the measurement mode of the meter, be careful of the short-circuits with other parts.

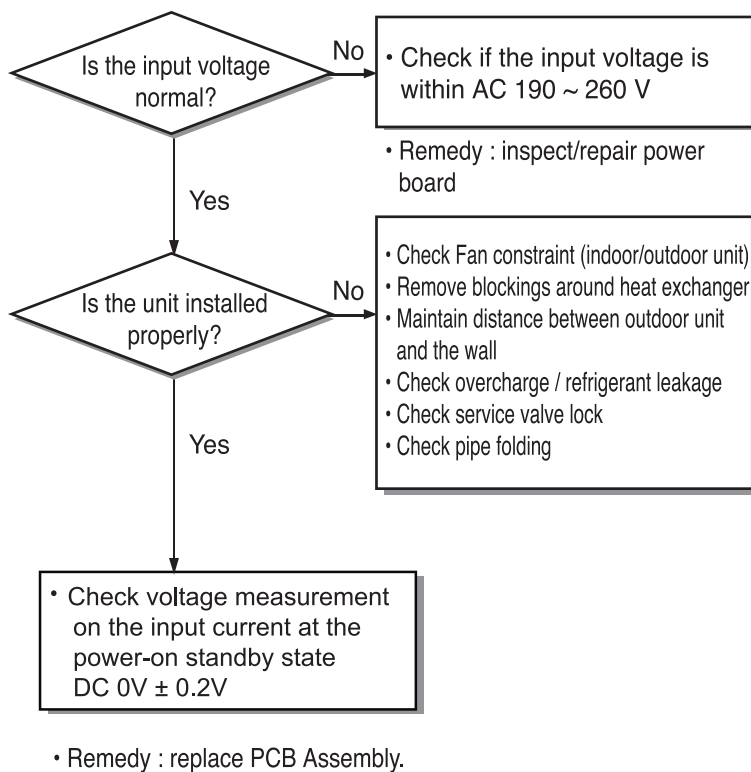

Inspecting PCB input current sensing circuit

1. Set Multi-tester as DC voltage measurement mode.
2. Measure the measuring point DC voltages at Power-on standby state.
3. If the measurements are outside DC 2.5V ± 0.2V, the parts are decided as burned.

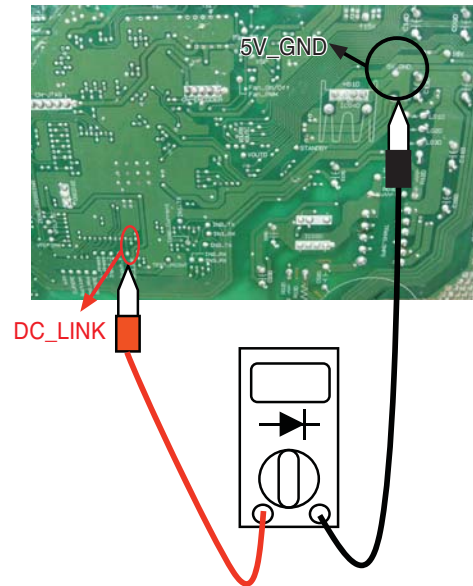

Display code	Title	Cause of error	Check point & Normal condition
23	DC Link High / Low Volt	<ul style="list-style-type: none"> • DC Link Voltage is above 420Vdc • DC Link Voltage is below 140Vdc 	<ul style="list-style-type: none"> • Check Input Voltage • Check PCB DC Link voltage sensor parts

! WARNING

Before checking PCB or each outdoor electric parts, wait for 3 minutes after the power is off. When measuring at standby state of power supply, after checking the measurement mode of the meter, be careful of the short-circuits with other parts.

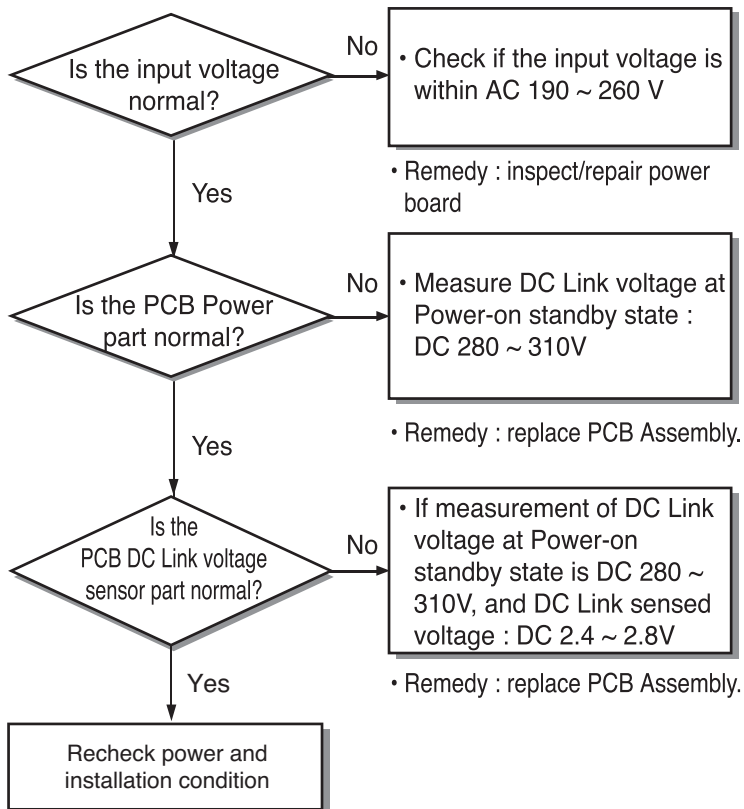

• Inspecting PCB DC Link voltage sensing circuit

1. Set Multi-tester as DC voltage measurement mode.
2. Measure the measuring point DC voltages at Power-on standby state.
3. If the measurements are outside DC 2.4 ~ 2.8V, the parts are decided as burned.

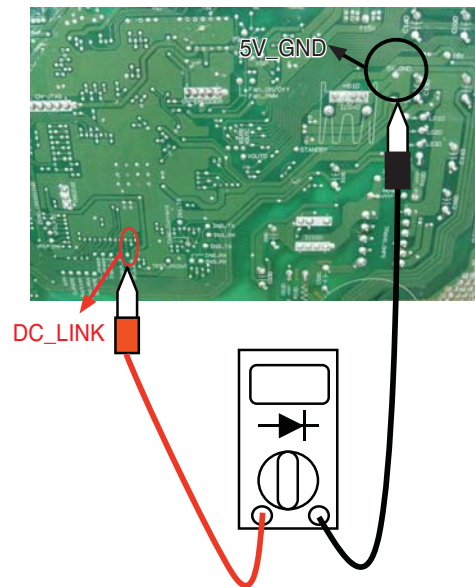

Part 5. Trouble Shooting

Display code	Title	Cause of error	Check point & Normal condition
25	Input Voltage high/low	Input voltage is over limited value of the product (140V or less, 300V or more)	1. Input voltage abnormal (R-S-T) 2. Outdoor unit main PCB assembly damage (input voltage sensing part)

■ Error Diagnosis and Countermeasure Flow Chart

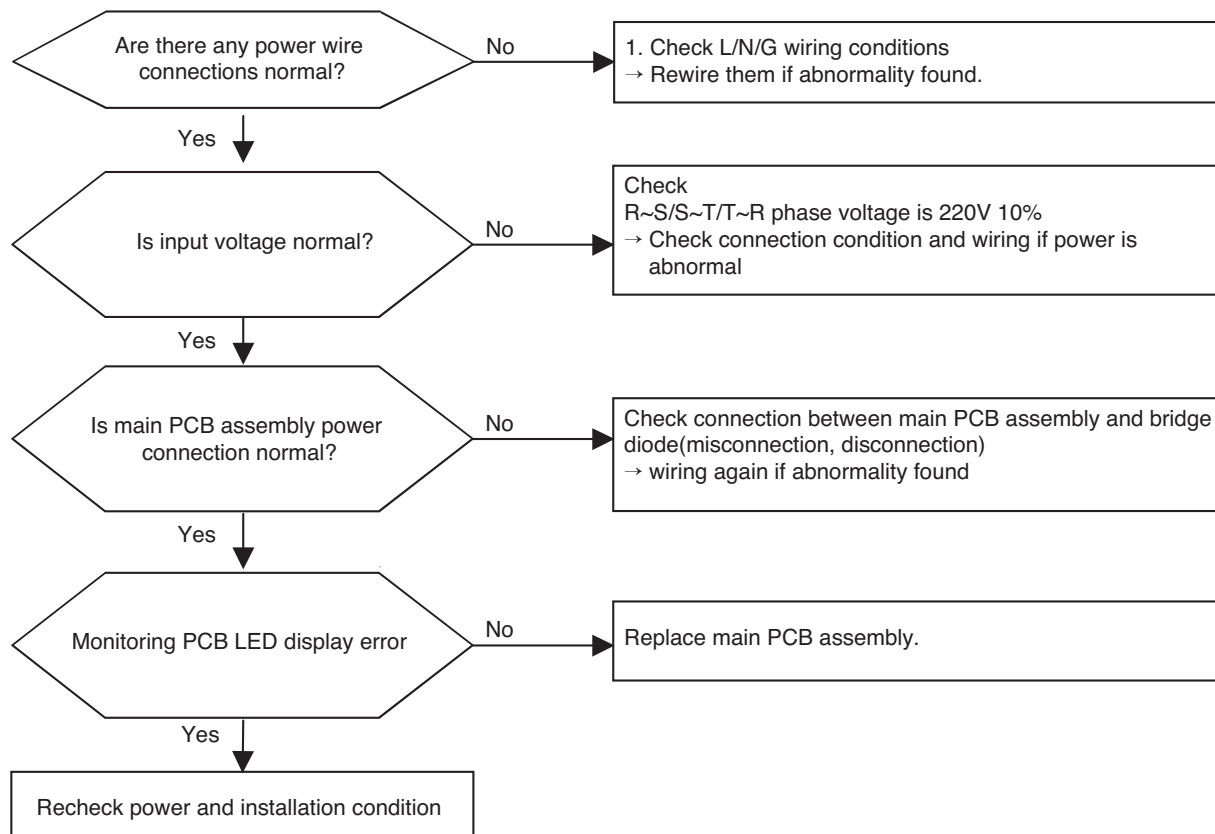

Display code	Title	Cause of error	Check point & Normal condition
26	Over-current at the initial operation of the compressor / location sensing signal for compressor operation is not input	<ul style="list-style-type: none"> Compressor Locking Overload operation (Outdoor fan constraint, screened, blocked) Burned parts inside PCB(IPM) Burned PCB phase current sensing circuit parts 	<ul style="list-style-type: none"> Check compressor locking Compressor wire open/short Check compressor insulation damage Check outdoor fan constraint / screened / flow structure Check if IMP burned (refer to CH21) Check on-PCB current sensing circuit parts

! WARNING

Before checking PCB or each outdoor electric parts, wait for 3 minutes after the power is off. When measuring at standby state of power supply, after checking the measurement mode of the meter, be careful of the short-circuits with other parts.

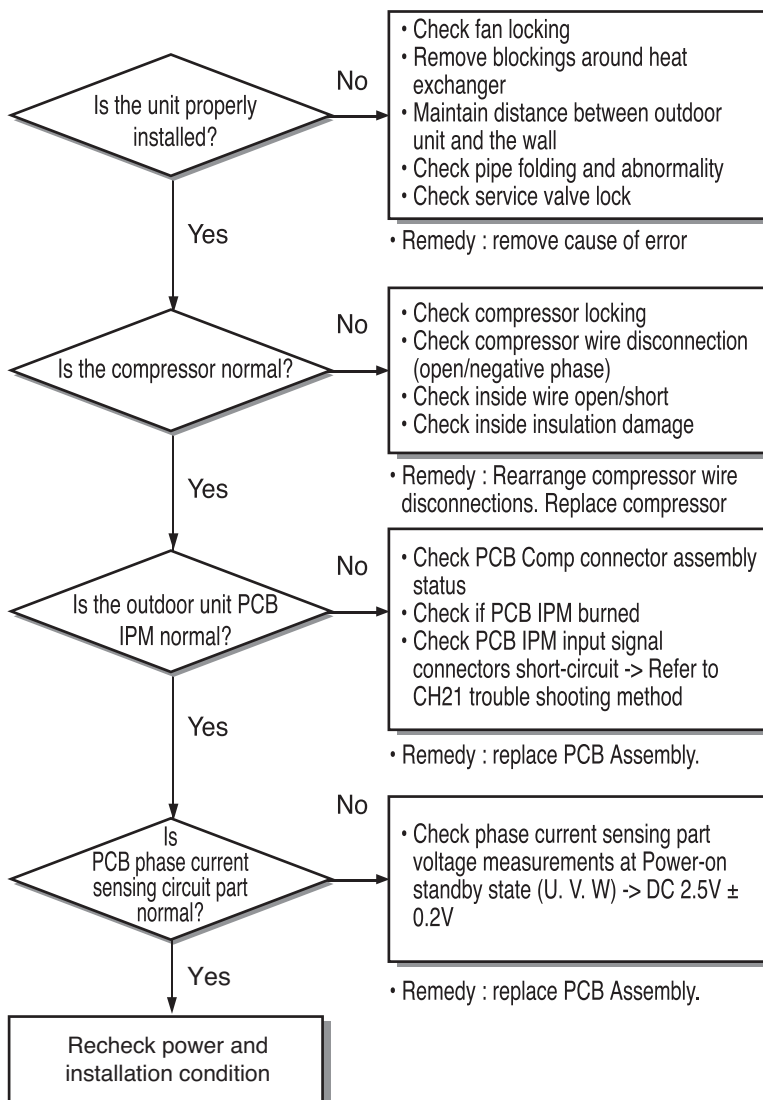

Inspecting PCB phase current sensing circuit

1. Set Multi-tester as DC voltage measurement mode.
2. Measure the below measuring point DC voltages at Power-on standby state.
3. If the measurements are outside DC 2.5V ± 0.2V, the parts are decided as burned.

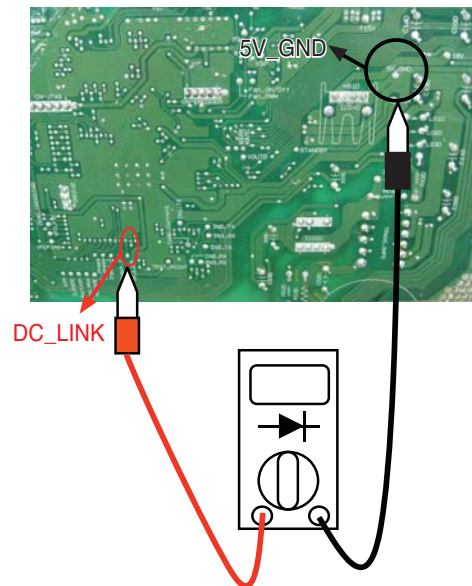

Display code	Title	Cause of error	Check point & Normal condition
27	Over-current on AC → DC converter circuit	<ul style="list-style-type: none"> • Overload operation (Outdoor fan constraint, screened, blocked) • Wrong application of Reactor Spec. • Burned PCB internal parts (PSC Module) 	<ul style="list-style-type: none"> • Check outdoor fan constraint/ screened/ flow structure • Check Reactor Spec: 11A/ 13mH • Check for PCB internal part burn



WARNING

Before checking PCB or each outdoor electric parts, wait for 3 minutes after the power is off. When measuring at standby state of power supply, after checking the measurement mode of the meter, be careful of the short-circuits with other parts.

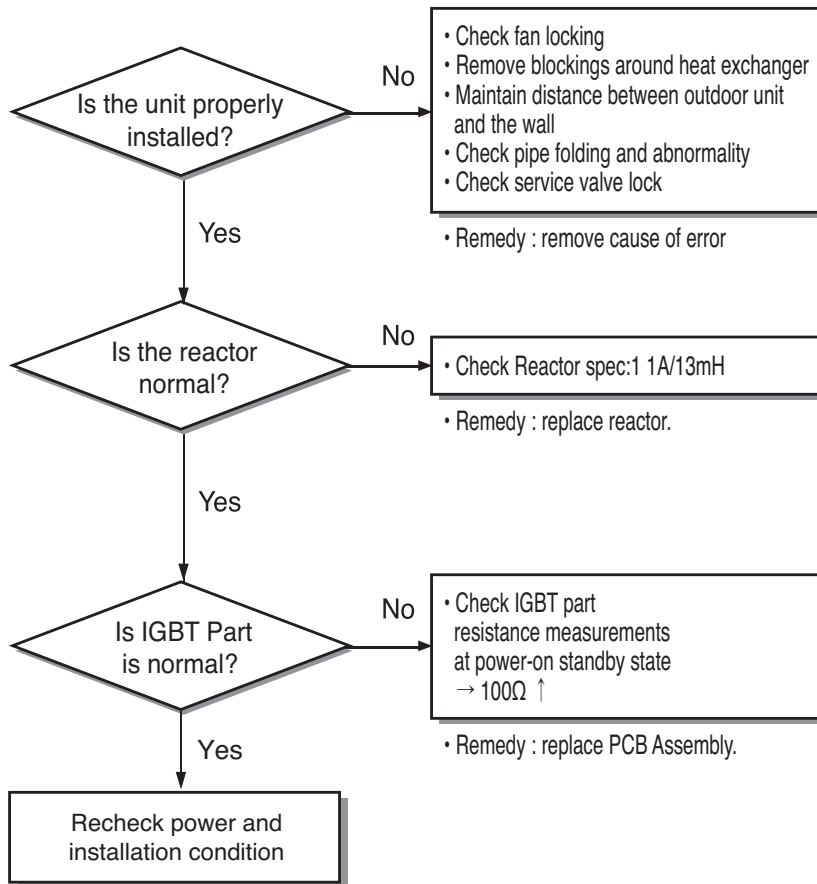

Inspecting PCB IGBT part

1. Remove the connectors to the PCB.
2. Set Multi-tester as Resistance measurement mode
3. Measure Resistance of Gate-collector, Emitter-collector.
4. If the measurements are $1M\Omega \downarrow$, the parts are decided as burned.

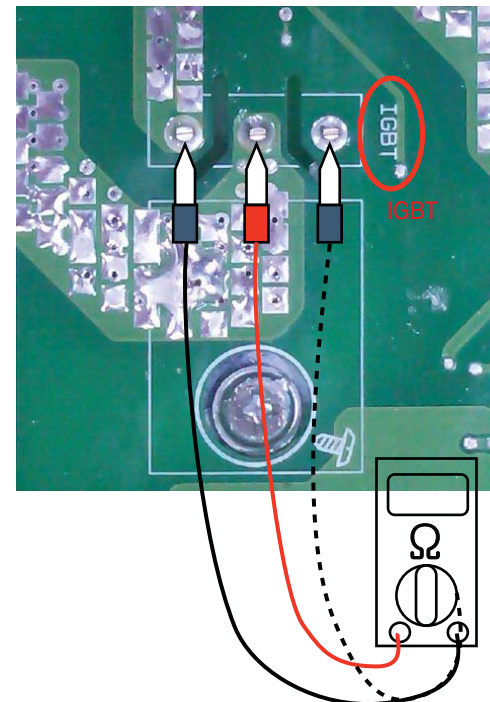

Display code	Title	Cause of error	Check point & Normal condition
29	Over-current at the initial operation of the compressor / location sensing signal for compressor operation is not input	<ul style="list-style-type: none"> Compressor Locking Overload operation (Outdoor fan constraint, screened, blocked) Burned parts inside PCB(IPM) Burned PCB phase current sensing circuit parts 	<ul style="list-style-type: none"> Check compressor locking Compressor wire open/short Check compressor insulation damage Check outdoor fan constraint / screened / flow structure Check if IMP burned (refer to CH21) Check on-PCB current sensing circuit parts

! WARNING

Before checking PCB or each outdoor electric parts, wait for 3 minutes after the power is off. When measuring at standby state of power supply, after checking the measurement mode of the meter, be careful of the short-circuits with other parts.

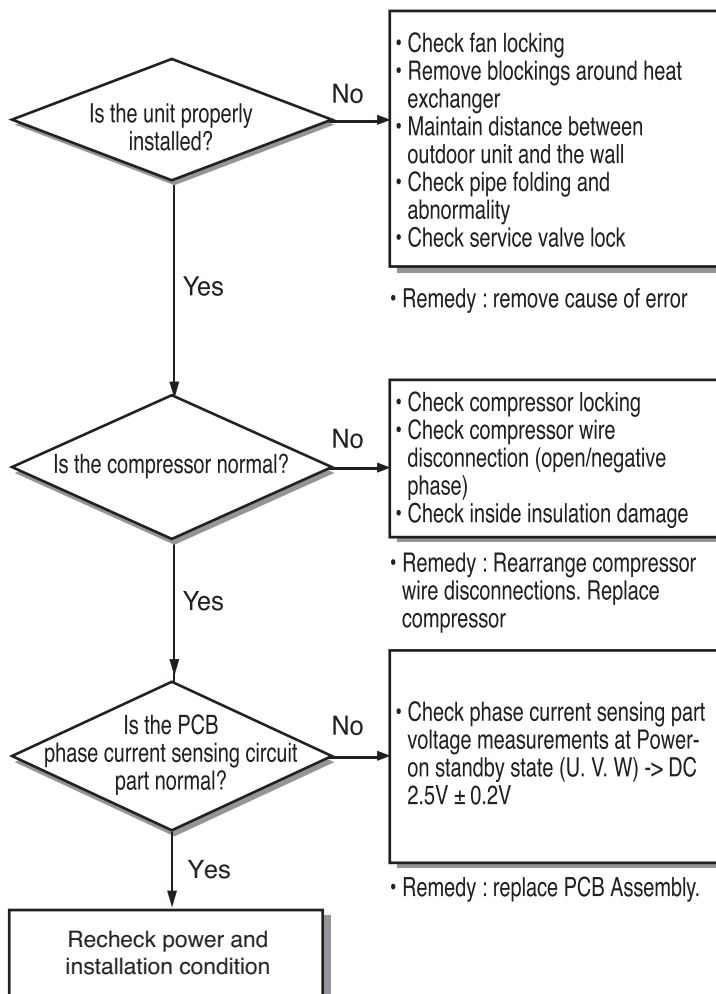

Inspecting PCB phase current sensing circuit

1. Set Multi-tester as DC voltage measurement mode.
2. Measure at the below measuring point DC voltages at Power-on standby state.
3. If the measurements are outside DC 2.5V ± 0.2V, the parts are decided as burned.

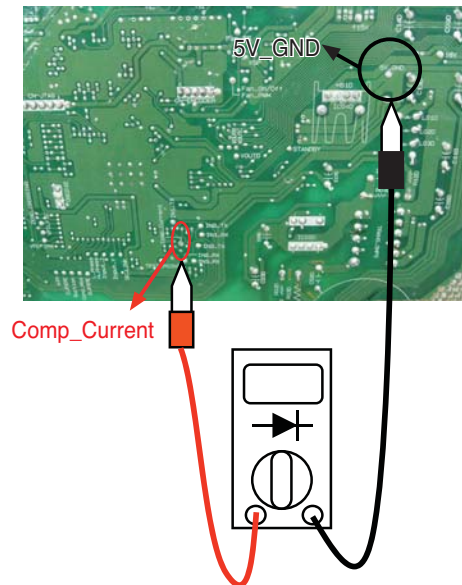

Display code	Title	Cause of error	Check point & Normal condition
32	High temperature in Discharge pipe of the inverter compressor	<ul style="list-style-type: none"> • Overload operation (Outdoor fan constraint, screened, blocked) • Refrigerant leakage (insufficient) • Poor INV Comp Discharge sensor • LEV connector displaced / poor LEV assembly 	<ul style="list-style-type: none"> • Check outdoor fan constraint/ screened/ flow structure • Check refrigerant leakage • Check if the sensor is normal • Check the status of EEV assembly



WARNING

Before checking PCB or each outdoor electric parts, wait for 3 minutes after the power is off. When measuring at standby state of power supply, after checking the measurement mode of the meter, be careful of the short-circuits with other parts.

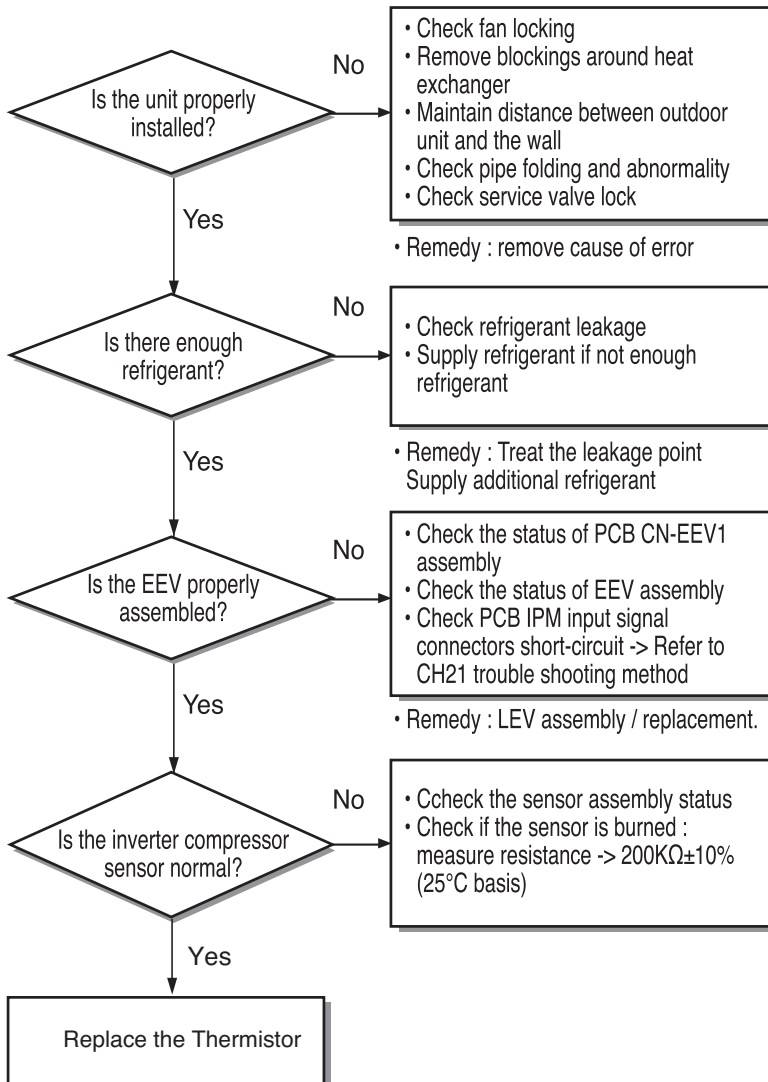

Inspecting Inverter Compressor Discharge Sensor

1. Set Multi-tester as resistance measurement mode.
2. Measure the resistance between inverter discharge sensor connector pins.
3. Measure resistance value of $200K\Omega \pm 10\%$, $25^{\circ}C$ basis
4. Check if the sensor insulation is damaged. -> measure the resistance between sensor connector pin and unit assembly pipe. ($1M\Omega$ or more)

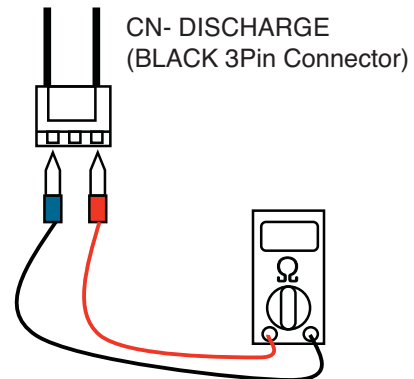

Display code	Title	Cause of error	Check point & Normal condition
35	Low Presser Error	Excessive decrease of low pressure	<ul style="list-style-type: none"> • Defective low pressure sensor • Defective outdoor/indoor unit fan • Refrigerant shortage/leakage • Deformation because of damage of refrigerant pipe • Defective indoor / outdoor unit EEV • Covering / clogging (outdoor unit covering during the cooling mode / indoor unit filter clogging during heating mode) • SVC valve clogging • Defective outdoor unit PCB • Defective indoor unit pipe sensor

■ Error diagnosis and countermeasure flow chart

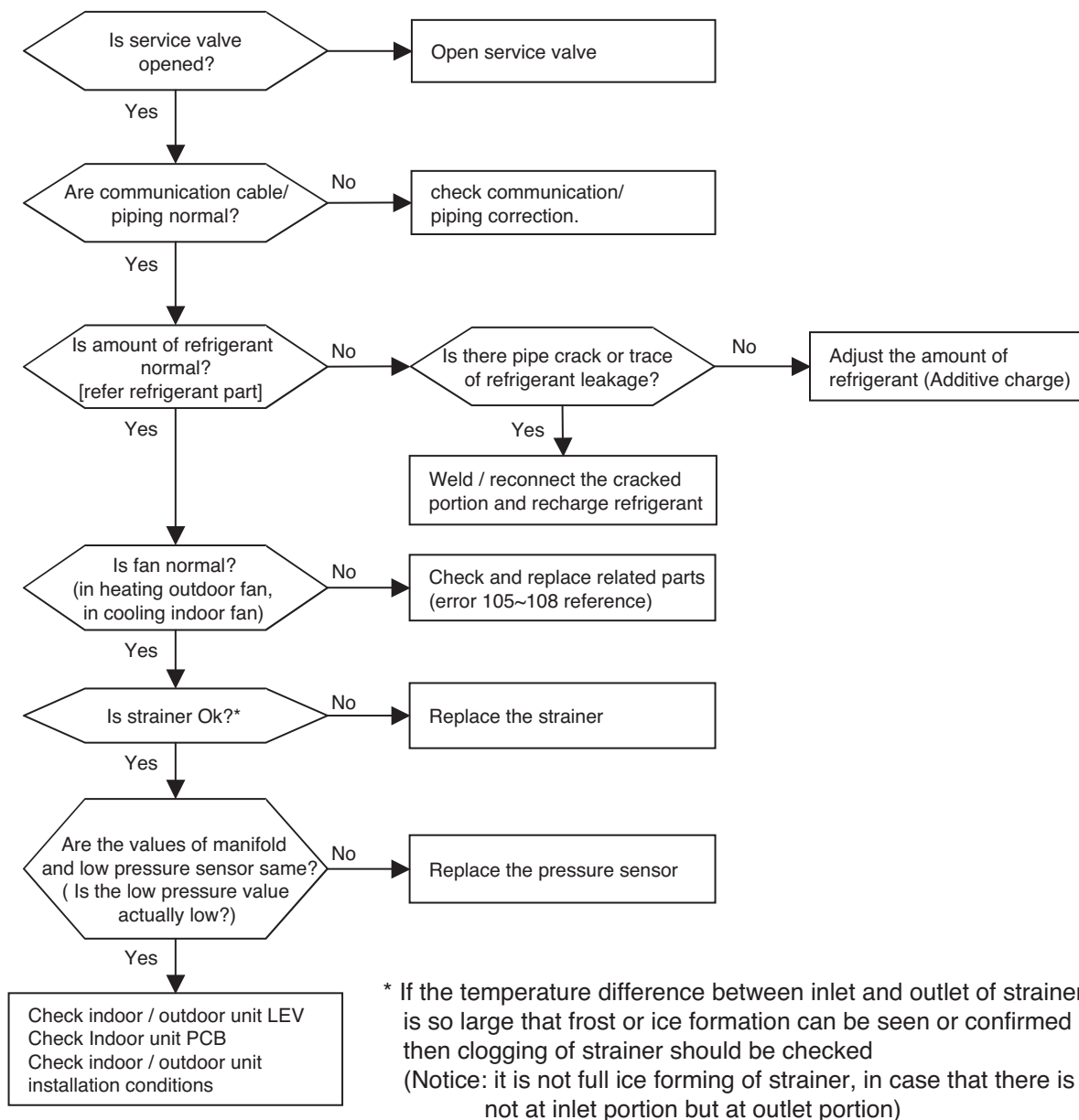

Display code	Title	Cause of error	Check point & Normal condition
40	AC Input current / Comp phase current sensing circuit - basic voltage sensing error	<ul style="list-style-type: none"> PCB sensing circuit part burned 	<ul style="list-style-type: none"> Check power input connector, Comp output current sensing circuit



WARNING

Before checking PCB or each outdoor electric parts, wait for 3 minutes after the power is off. When measuring at standby state of power supply, after checking the measurement mode of the meter, be careful of the short-circuits with other parts.

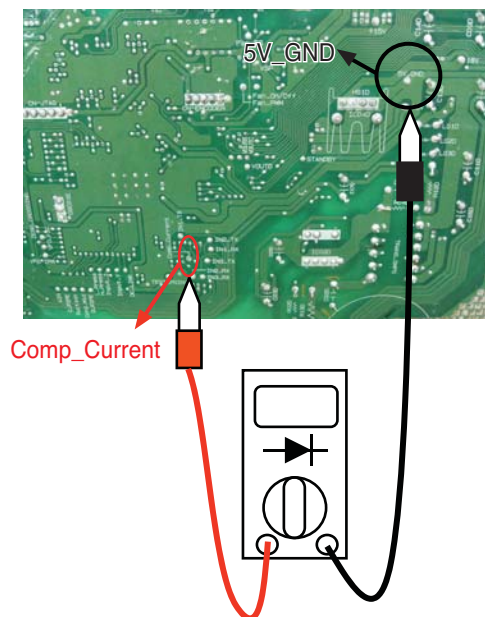
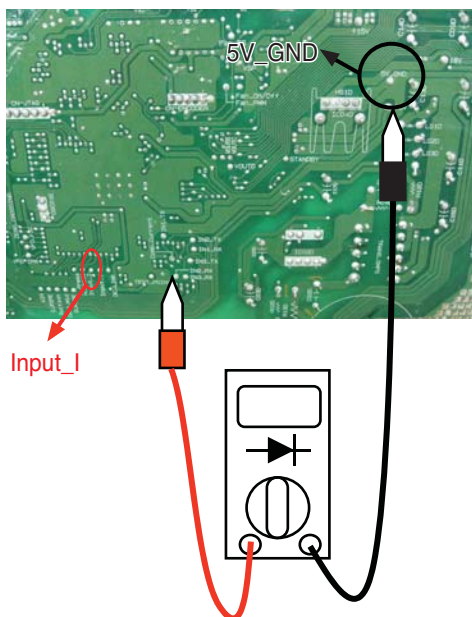
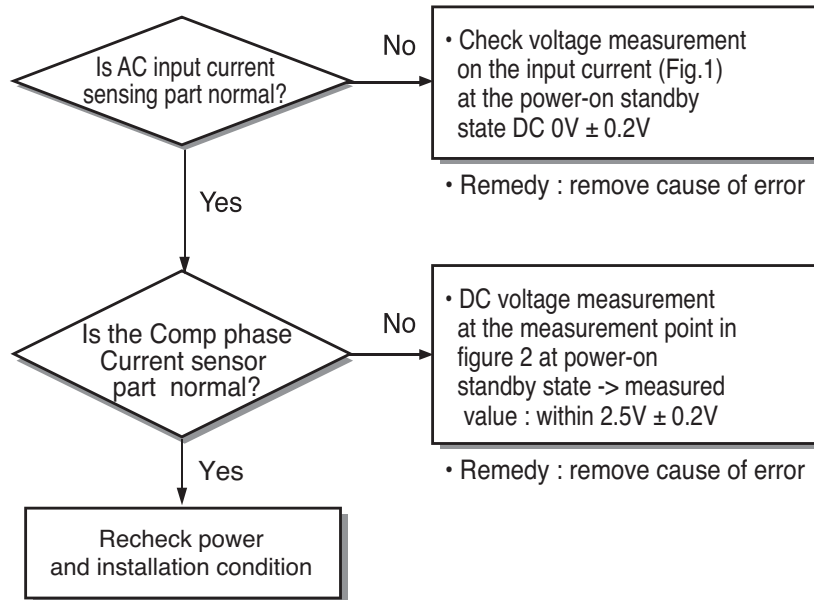

Display code	Title	Cause of error	Check point & Normal condition
41	D-pipe sensor (Inverter)	<ul style="list-style-type: none"> • Open / Short • Soldered poorly • Internal circuit error 	• Normal resistor : 200KΩ / at 25°C (Unplugged)
44	Air sensor	<ul style="list-style-type: none"> • Open / Short • Soldered poorly • Internal circuit error 	• Normal resistor : 10KΩ / at 25°C (Unplugged)
45	Condenser Mid-pipesensor	<ul style="list-style-type: none"> • Open / Short • Soldered poorly • Internal circuit error 	• Normal resistor : 5KΩ / at 25°C (Unplugged)
46	Suction Pipe sensor	<ul style="list-style-type: none"> • Open / Short • Soldered poorly • Internal circuit error 	• Normal resistor : 5KΩ / at 25°C (Unplugged)
48	Condenser Out-pipe sensor	<ul style="list-style-type: none"> • Open / Short • Soldered poorly • Internal circuit error 	• Normal resistor : 5KΩ / at 25°C (Unplugged)

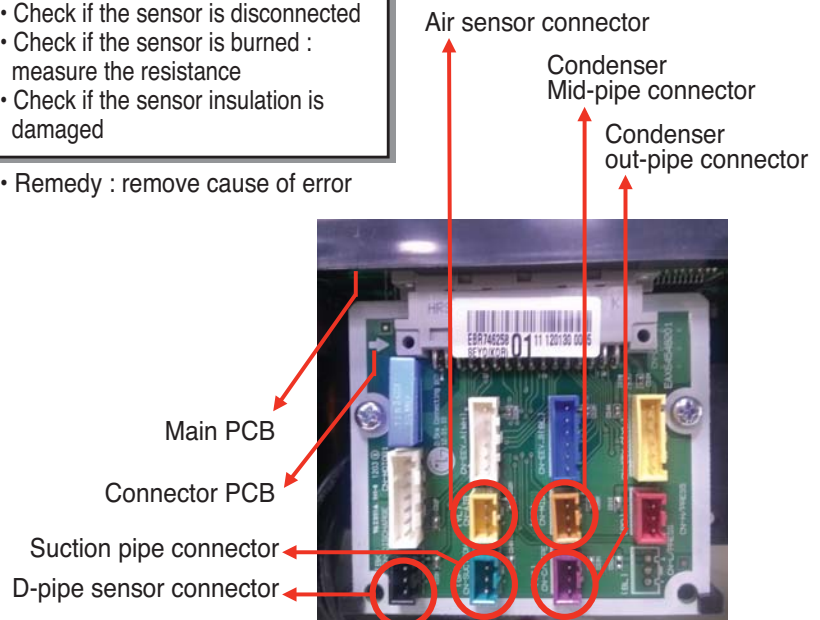
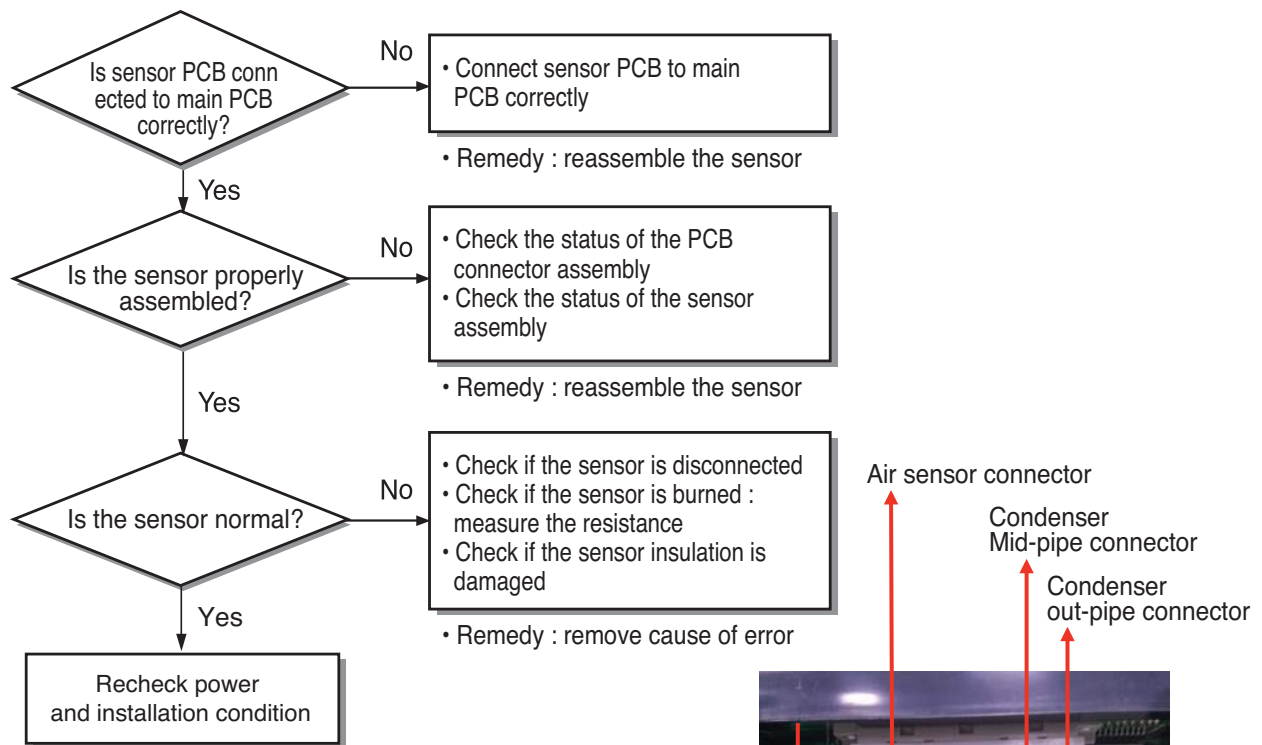

Part 5. Trouble Shooting

Display code	Title	Cause of error	Check point & Normal condition
43	Sensor error of high pressure	Abnormal value of sensor (Open/Short)	<ul style="list-style-type: none"> • Bad connection of connector PCB • Bad connection high pressure connector • Defect of high pressure connector (Open/Short) • Defect of connector PCB (Open/Short) • Defect of outdoor main PCB.

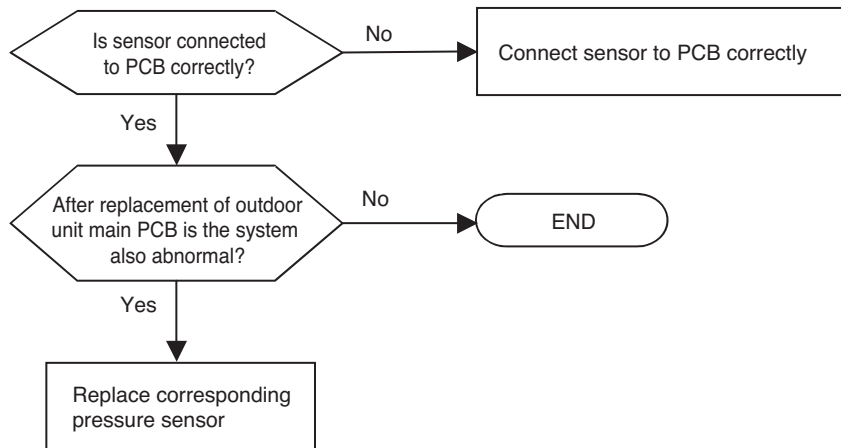

Display code	Title	Cause of error	Check point & Normal condition
51	Over capacity	• Over capacity Combination	<ul style="list-style-type: none"> • Check the indoor unit capacity. • Check the combination table.

Model	Gross max.capacity	Max.single indoor unit capacity
A2UW18GFA0	24k	18k
A3UW24GFA0	33k	24k

Check Point

• CH 51

1. Check the indoor unit capacity.
2. Check the combination table.

Display code	Title	Cause of error	Check point & Normal condition
53	If the data transmitted by the indoor unit is not received for 3 minutes continuously.	<ul style="list-style-type: none"> No power on indoor unit Indoor/outdoor unit Power connection error/communication error caused by external noise Indoor/outdoor unit communication circuit parts burned 	<ul style="list-style-type: none"> Check indoor unit power status Check indoor/outdoor unit power/communication line disconnection Check the status of indoor/outdoor unit ground connections Check if outdoor unit communication parts are burned



WARNING

Before checking PCB or each outdoor electric parts, wait for 3 minutes after the power is off. When measuring at standby state of power supply, after checking the measurement mode of the meter, be careful of the short-circuits with other parts.

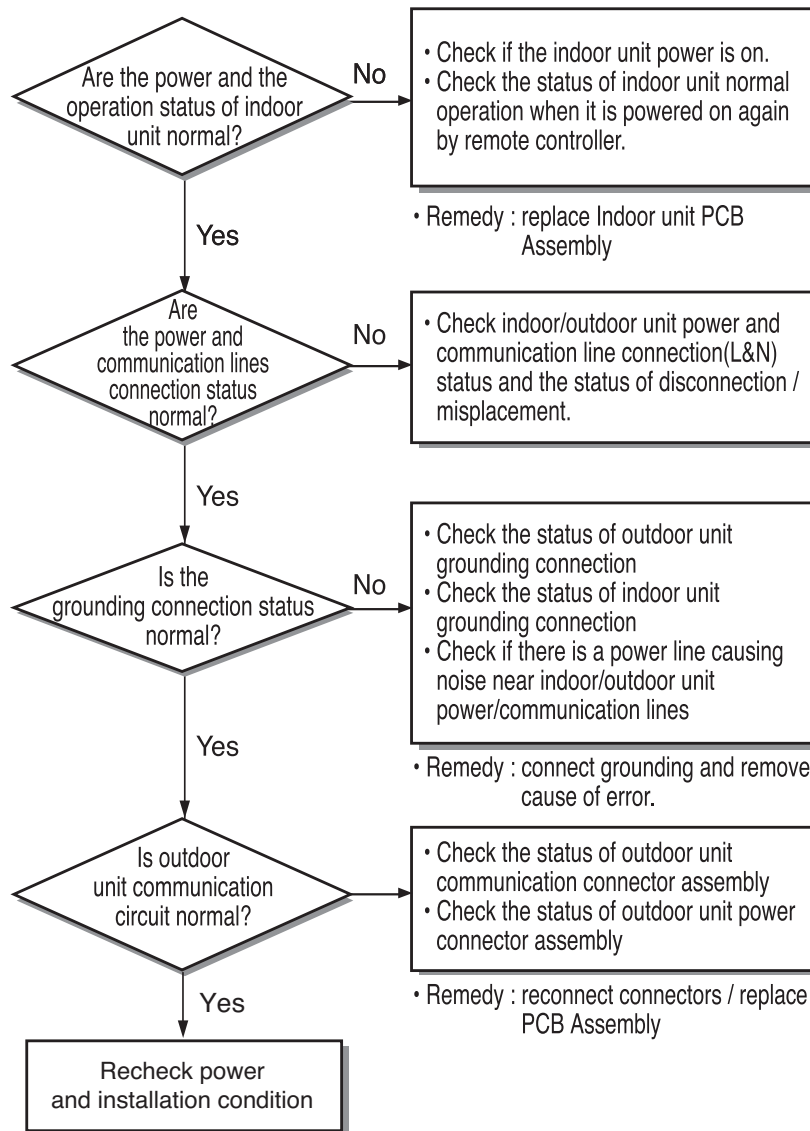

Display code	Title	Cause of error	Check point & Normal condition
60	Incorrect checksum of outdoor unit PCB EEPROM	<ul style="list-style-type: none"> Outdoor unit PCB EEPROM misapplied Outdoor unit PCB EEPROM poor assembly 	EEPROM assembly



WARNING

Before checking PCB or each outdoor electric parts, wait for 3 minutes after the power is off. When measuring at standby state of power supply, after checking the measurement mode of the meter, be careful of the short-circuits with other parts.

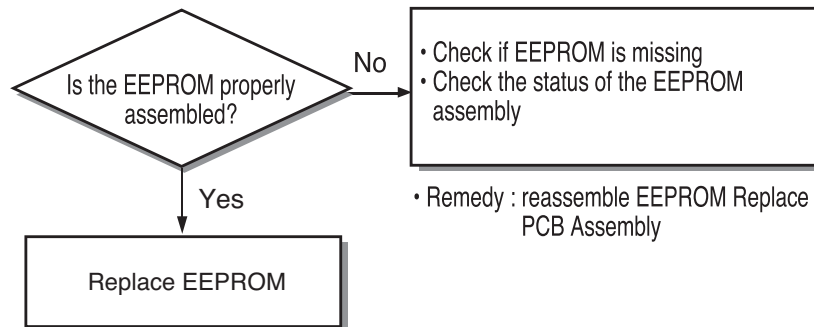

- Inspecting Outdoor EEPROM Assembly Status
- 1. Check the consistency of the EEPROM's direction inserted in the PCB and the EEPROM marking.

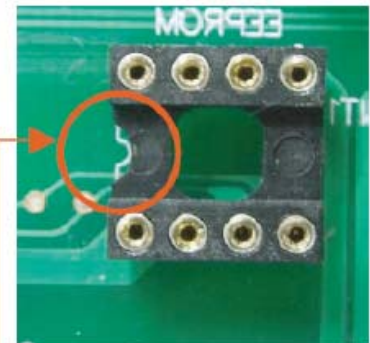

<EEPROM Direction Check Point>

Display code	Title	Cause of error	Check point & Normal condition
61	High temperature in outdoor Cond. Pipe	<ul style="list-style-type: none"> • Overload operation (Outdoor fan constraint, screened, blocked) • Outdoor unit heat exchanger contaminated • EEV connector displaced / poor EEV assembly • Poor Cond. Pipe sensor assembly / burned 	<ul style="list-style-type: none"> • Check outdoor fan constraint / screened / flow structure • Check if refrigerant overcharged • Check the status of EEV assembly • Check the status of sensor assembly / burn

! WARNING

Before checking PCB or each outdoor electric parts, wait for 3 minutes after the power is off. When measuring at standby state of power supply, after checking the measurement mode of the meter, be careful of the short-circuits with other parts.

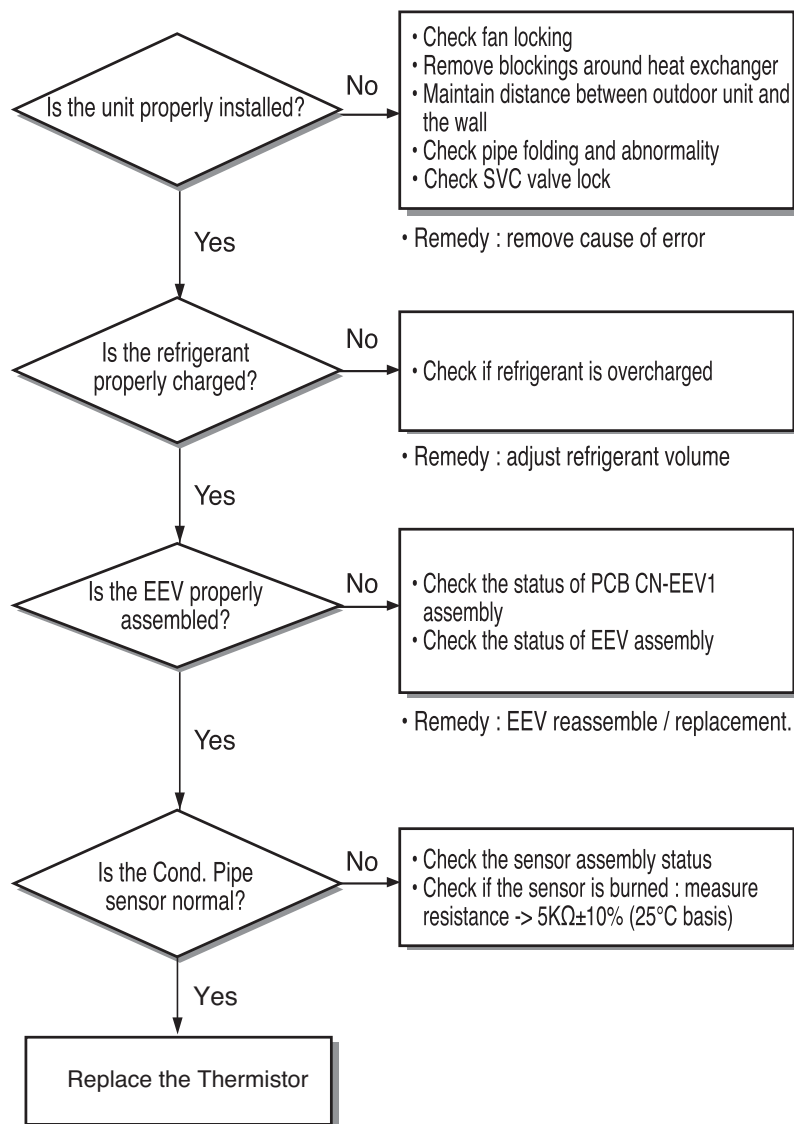

• Inspecting Cond. Pipe Sensor

1. Set Multi-tester as resistance measurement mode.
2. Measure the resistance between rated speed Comp Discharge sensor connector pins.
3. Measure resistance value of $5k\Omega \pm 10\%$, 25°C basis
4. Check if the sensor insulation is damaged. -> measure the resistance between sensor connector pin and unit assembly pipe. ($1M\Omega$ or more)

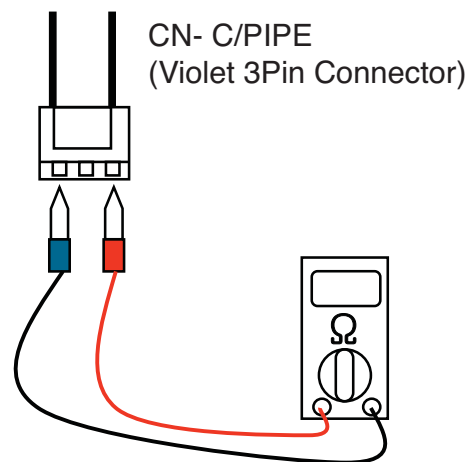

Display code	Title	Cause of error	Check point & Normal condition
62	Heat Sink High	Inverter PCB heatsink temperature is over 85°C	<ul style="list-style-type: none"> • ODU fan locking • Heatsink assembly of INV PCB assemble condition abnormal • Defect of temperature sensing circuit part defect of INV PCB

■ Error Diagnosis and Countermeasure Flow Chart

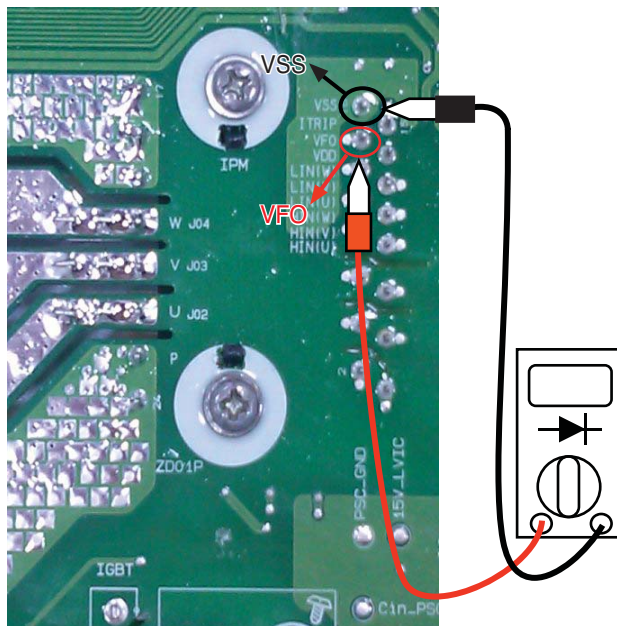
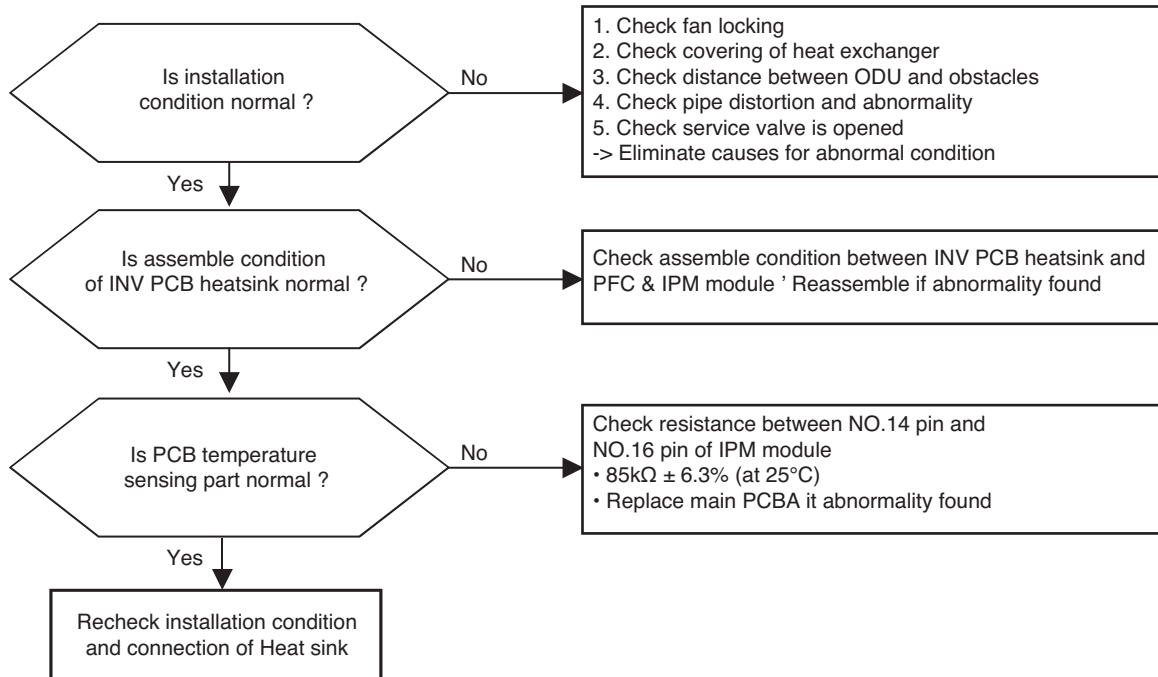

Display code	Title	Cause of error	Check point & Normal condition
65	Heatsink Sensor error	Inverter PCB heatsink sensor is open or short	<ul style="list-style-type: none"> • ODU fan locking • Heatsink assembly of INV PCB assemble condition abnormal • Defect of temperature sensing circuit part defect of INV PCB

■ Error Diagnosis and Countermeasure Flow Chart

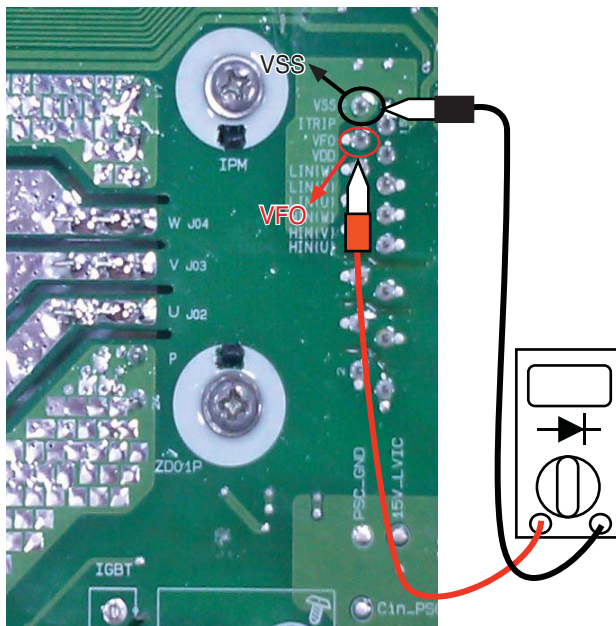
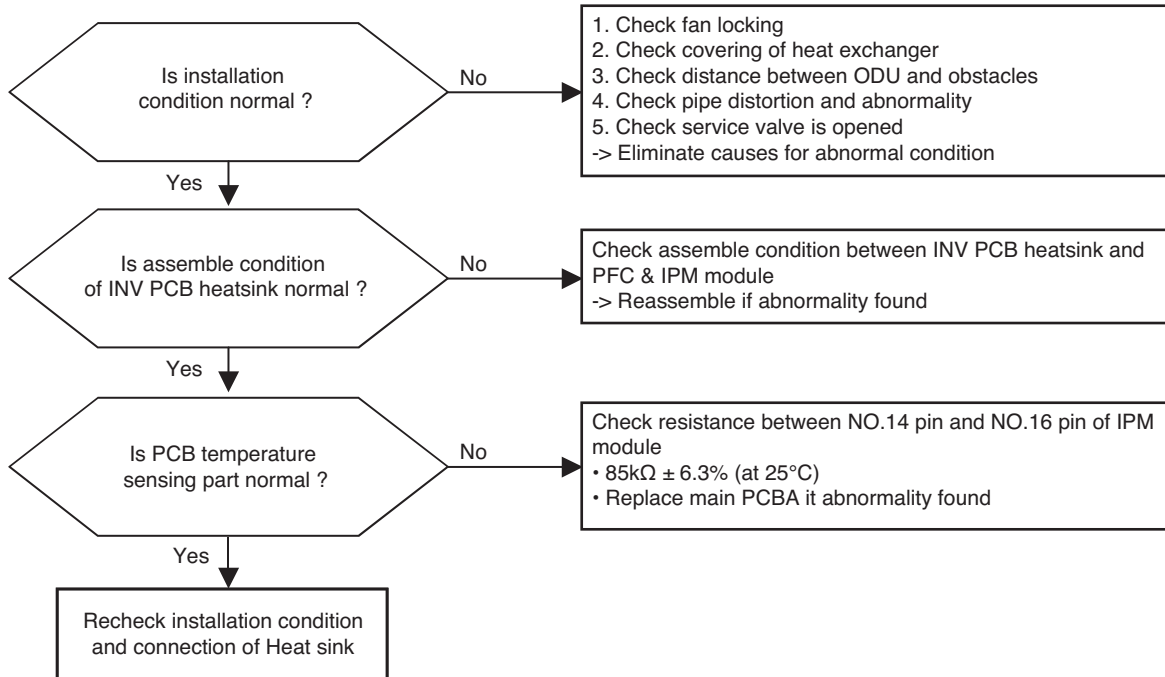

Display code	Title	Cause of error	Check point & Normal condition
67	Fan Lock Error	Fan RPM is 10RPM or less for 5 sec. when ODU fan starts or 40 RPM or less after fan starting.	<ul style="list-style-type: none"> • ODU fan locking • Heatsink assembly of INV PCB assemble condition abnormal • Defect of temperature sensing circuit part defect of INV PCB

■ Error Diagnosis and Countermeasure Flow Chart

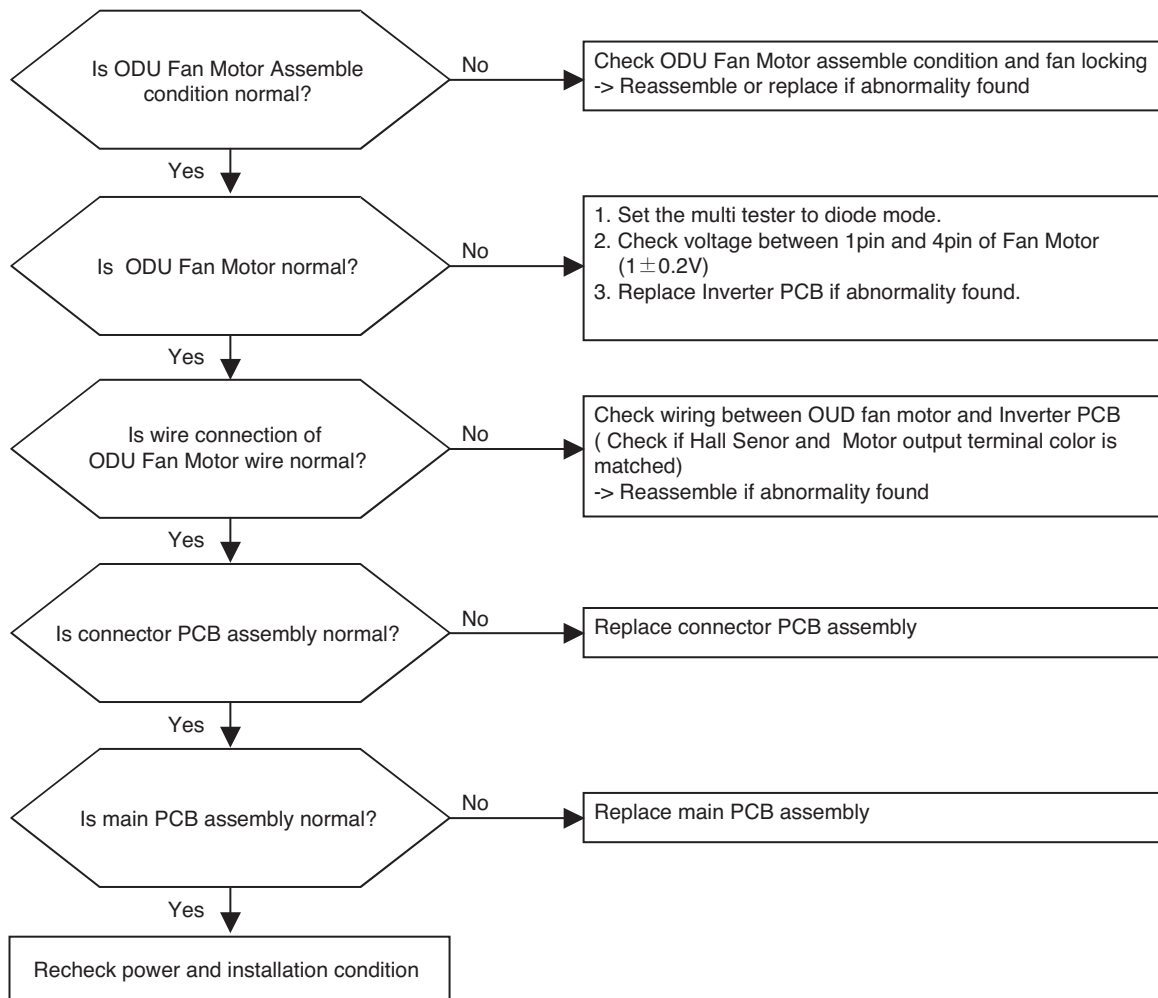

Check Point

1. Check voltage between 1pin and 4pin of Fan Mortor connector (Tester diode mode)
2. Voltage value should be in 1V ±0.2V.

► A4UW36GFA0/A8UW54GFA0

Display code	Title	Cause of error	Check point & Normal condition
21	DC PEAK (IPM Fault)	<ul style="list-style-type: none"> Instant over current Over Rated current Poor insulation of IPM 	<ul style="list-style-type: none"> An instant over current in the U,V,W phase <ul style="list-style-type: none"> Comp lock The abnormal connection of U,V,W Over load condition <ul style="list-style-type: none"> Overcharging of refrigerant Pipe length. Outdoor Fan is stop Poor insulation of compressor



WARNING

Before checking PCB or each outdoor electric parts, wait for 3 minutes after the power is off. When measuring at standby state of power supply, after checking the measurement mode of the meter, be careful of the short-circuits with other parts.

■ Error Diagnosis and Countermeasure Flow Chart

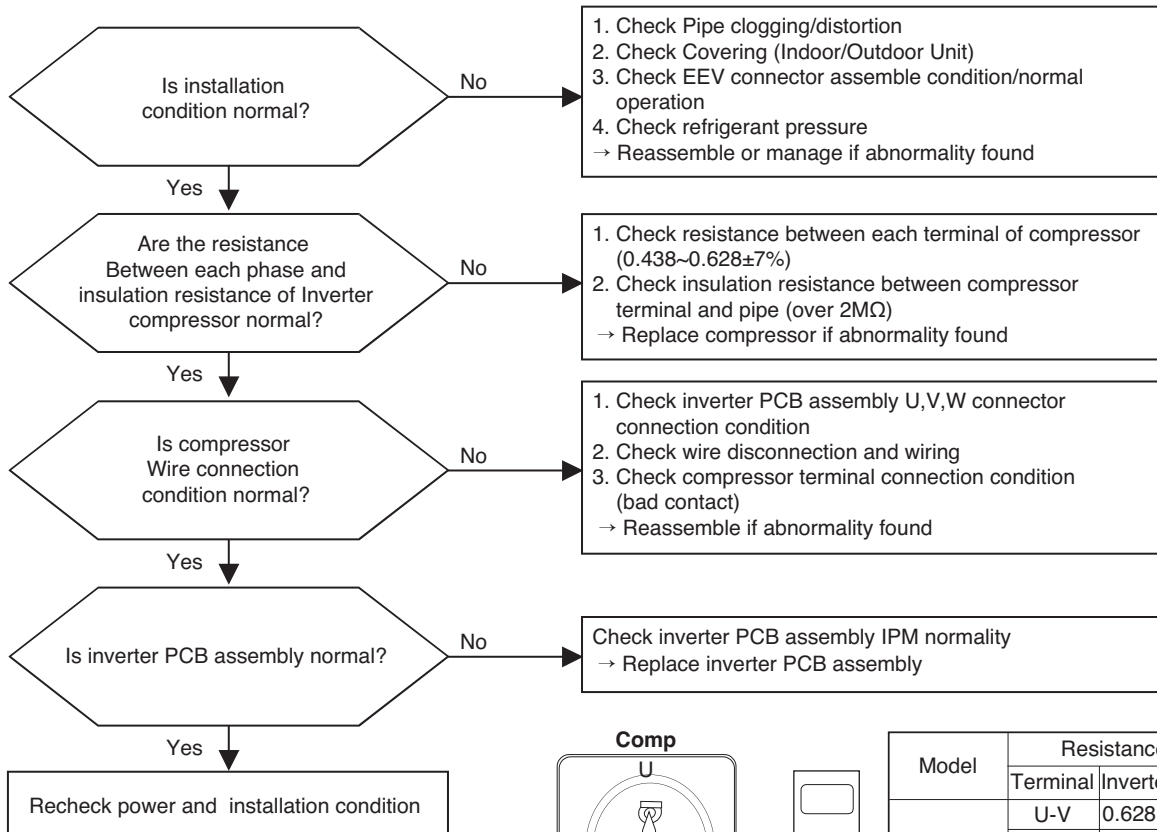

■ Comp checking method

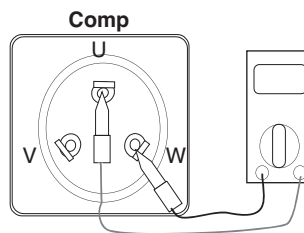

Model	Resistance(Ω)	
	Terminal	Inverter Comp.
36k	U-V	0.628(at 25°C)
	V-W	0.628(at 25°C)
	W-U	0.628(at 25°C)
54k	U-V	0.438(at 25°C)
	V-W	0.438(at 25°C)
	W-U	0.438(at 25°C)

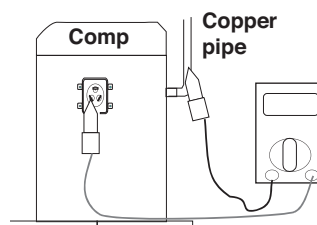

Resistance(Ω) at 20°C		
Terminal	Inverter comp.	Constant comp.
U-GND	2MΩ	2MΩ
V-GND	2MΩ	2MΩ
W-GND	2MΩ	2MΩ

■ 36k

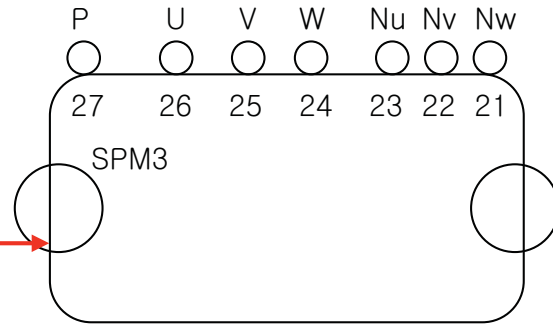
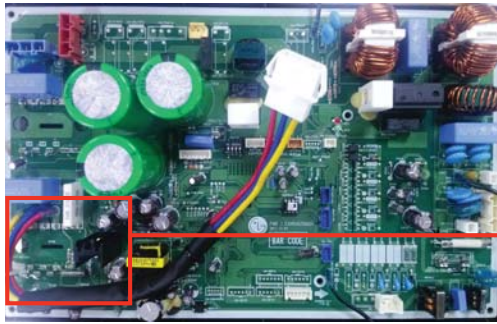

1. Wait until inverter PCB DC voltage is discharged after main power off.
2. Pull out V, V, W COMP connector.
3. Set multi tester to resistance mode.
4. If the value between P and N terminal of IPM is short(0Ω) or open(hundreds $M\Omega$), PCB needs to be replaced.(IPM damaged)
5. Set the multi tester to diode mode.
6. In case measured value is different from the table, PCB needs to be replaced.(PCB damaged).

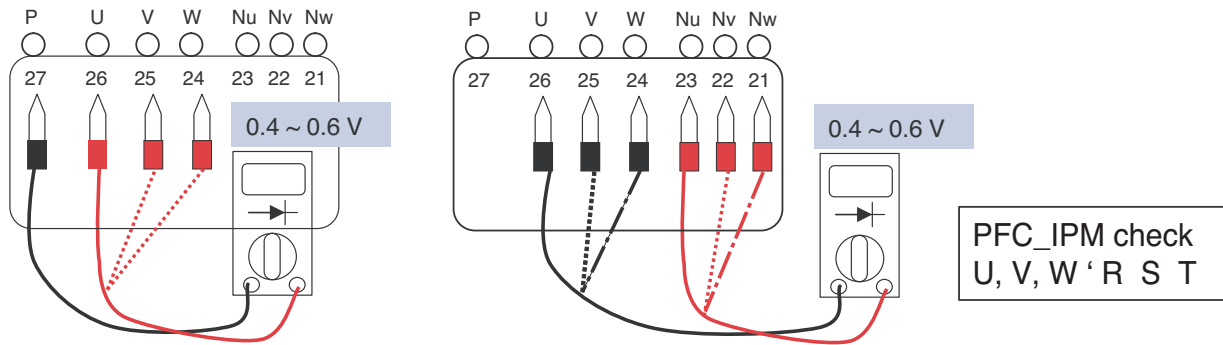

■ 54k

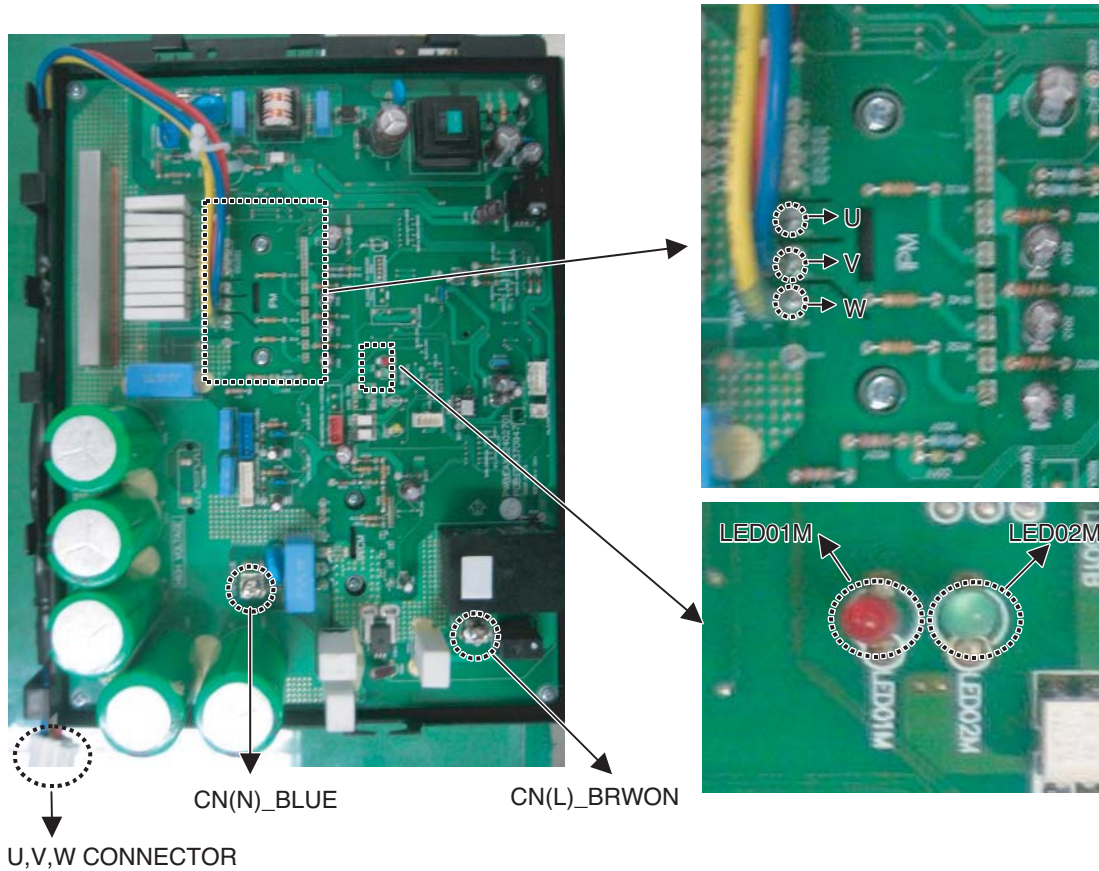

1. Wait until inverter PCB DC voltage is discharged after main power off.
2. Pull out CN(L), CN(N) connectors and U,V,W COMP Connector.
3. Set multi tester to resistance mode.
4. If the value between P and N terminal of IPM is short(0Ω) or open(hundreds $M\Omega$), PCB needs to be replaced.(IPM damaged)
5. Set the multi tester to diode mode.
6. In case measured value is different from the table, PCB needs to be replaced.(PCB damaged).

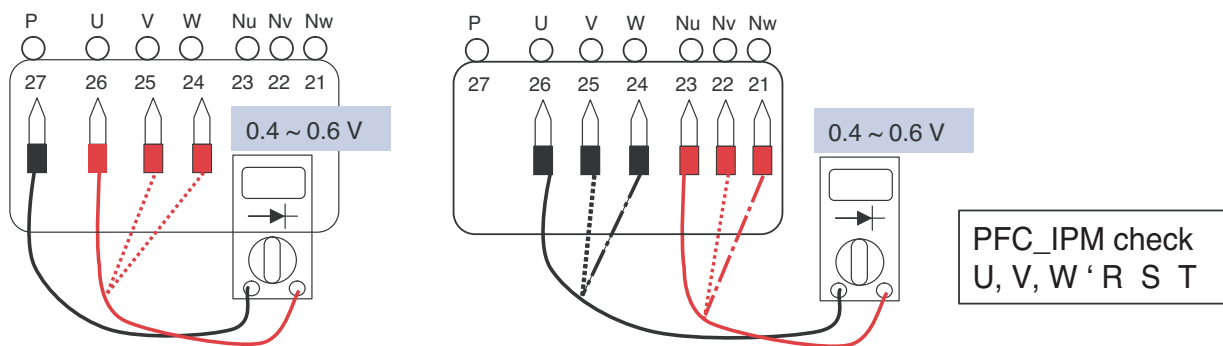

Display code	Title	Cause of error	Check point & Normal condition
22	Max. C/T	Input Over Current(36k-17A ↑ 54k-29A ↑)	1. Malfunction of Compressor 2. Blocking of Pipe 3. Low Voltage Input 4. Refrigerant, Pipe length, Blocked...



WARNING

Before checking PCB or each outdoor electric parts, wait for 3 minutes after the power is off. When measuring at standby state of power supply, after checking the measurement mode of the meter, be careful of the short-circuits with other parts.

■ Error Diagnosis and Countermeasure Flow Chart

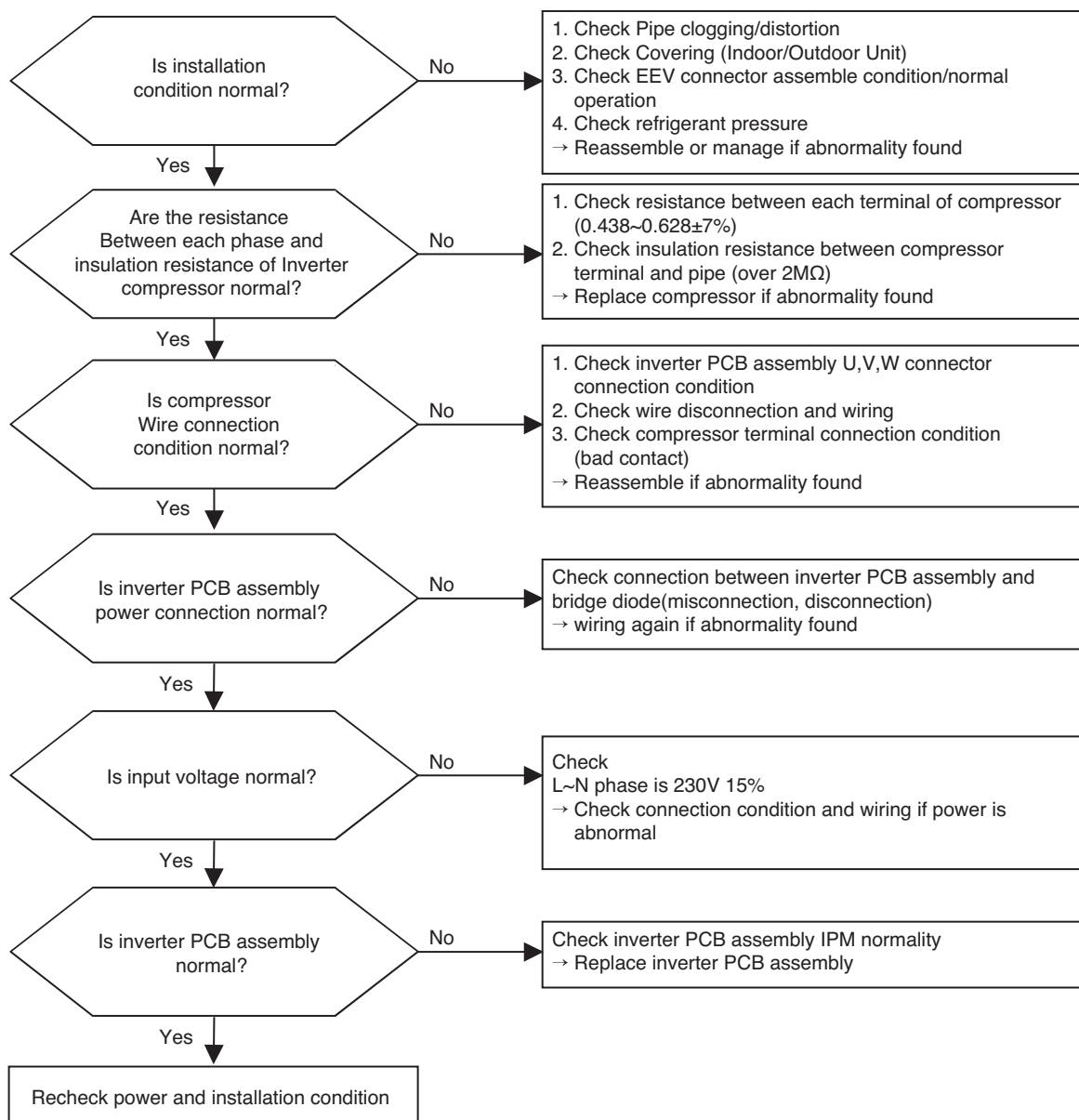

Check Point

1. Check the power source.(230V \pm 15%)
2. Check the fan operation is right.
3. Check the current.
4. Check the install condition.
5. Check the CT Sensor Output signal
(36k - Check output the CT Sensor : DC 2.5 \pm 0.2V)
(54k - Check output pin 1.2 of the CT Sensor : 5V)

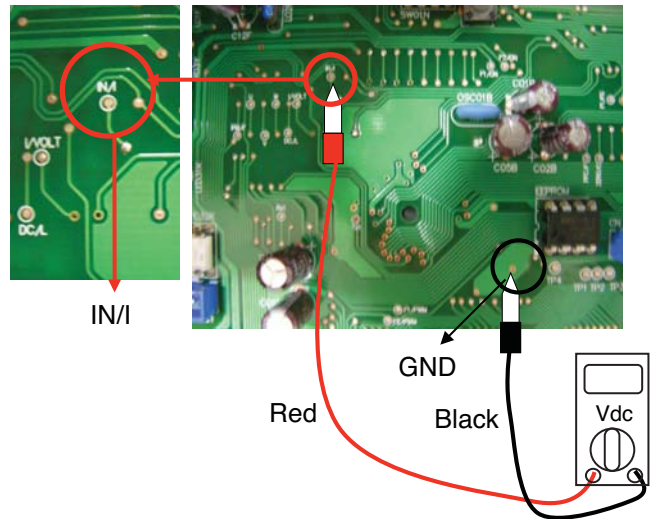
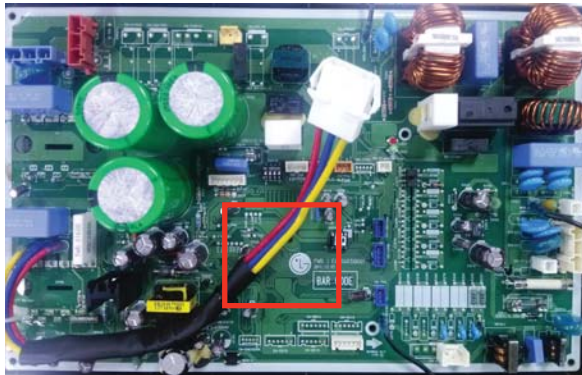

<CT Sensing Check Point>



< Inverter PCB>

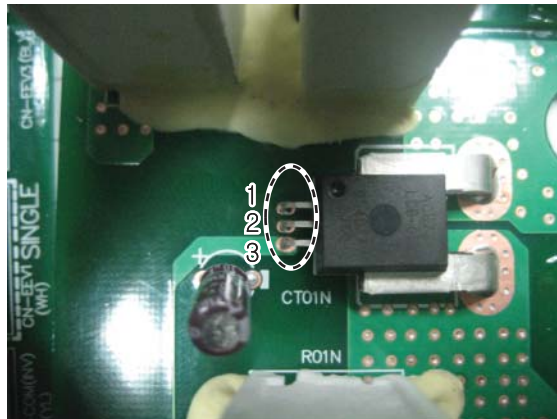

<CT Sensing Check Point>

Display code	Title	Cause of error	Check point & Normal condition
23	DC Link High / Low Volt	<ul style="list-style-type: none"> • DC Link Voltage is above 420Vdc • DC Link Voltage is below 140Vdc 	<ul style="list-style-type: none"> • Check CN_(L), CN_(N) Connection • Check Input Voltage • Check PCB DC Link voltage sensor parts



WARNING

Before checking PCB or each outdoor electric parts, wait for 3 minutes after the power is off. When measuring at standby state of power supply, after checking the measurement mode of the meter, be careful of the short-circuits with other parts.

■ Error Diagnosis and Countermeasure Flow Chart

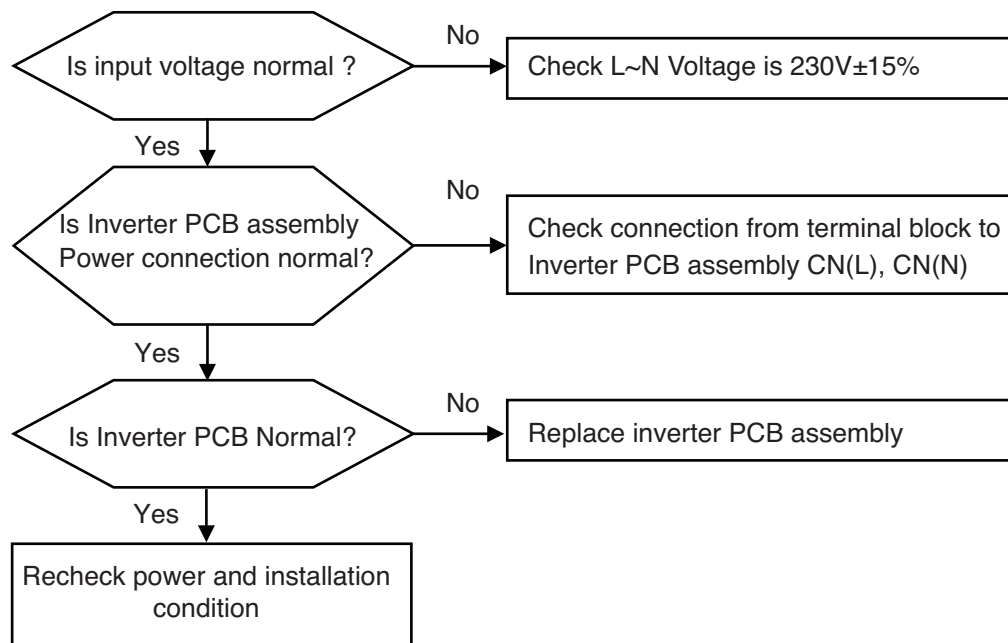

Check Point

1. Check the WCN_P(L),P(N) Connection condition at the Main PCB.(Refer to outdoor wiring diagram)
2. Check the DC Link voltage at not operating(280V ↑)
3. Check the DC Link voltage at Comp operating(340V ↑)
4. Check DC Link Sensing Signal :2.4~2.8V (Refer the Picture)

■ 36k

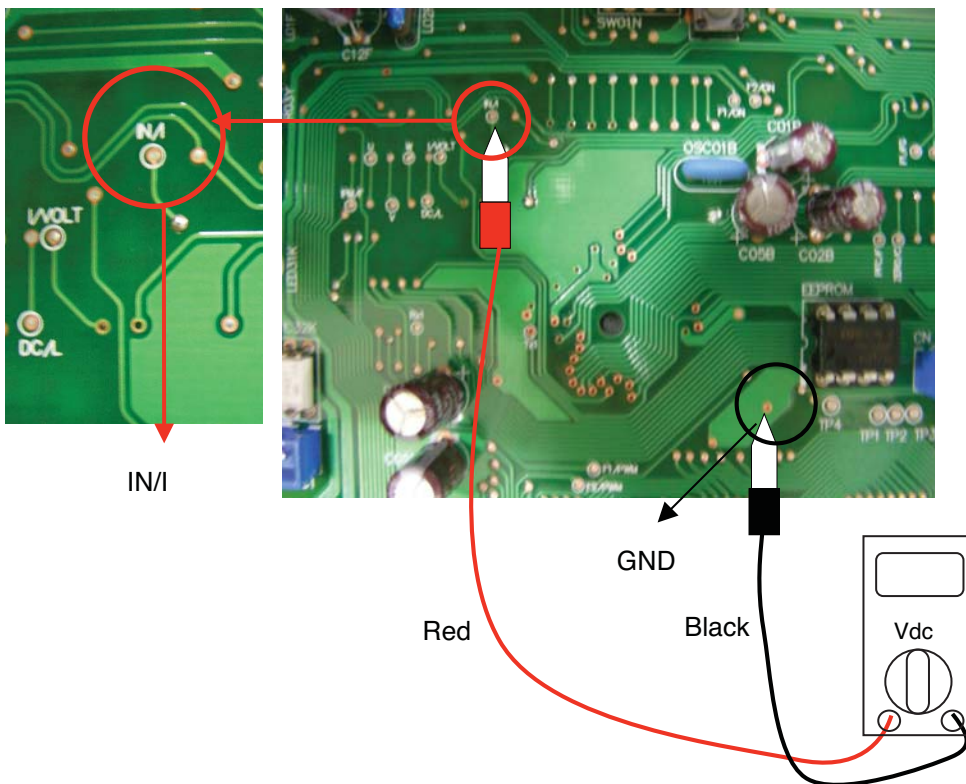
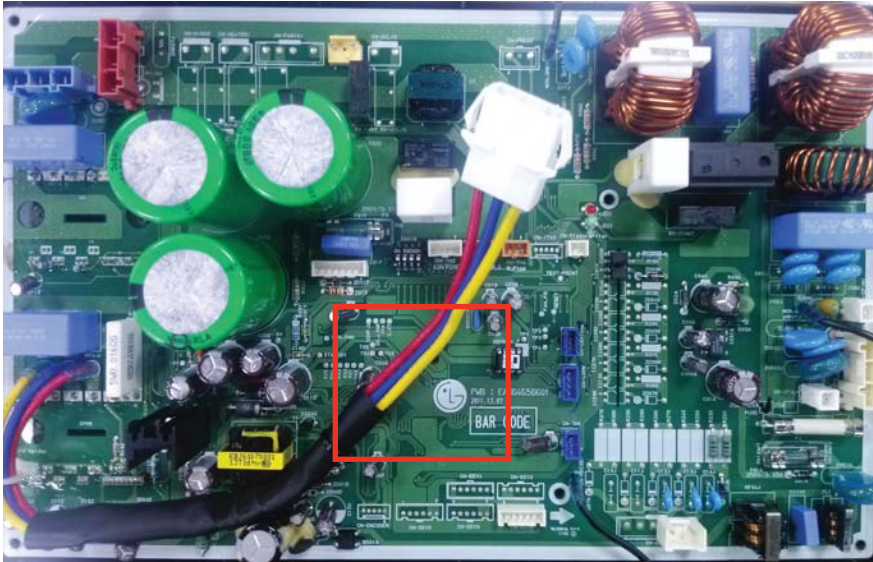

<CT Sensing Check Point>

▶ 54k

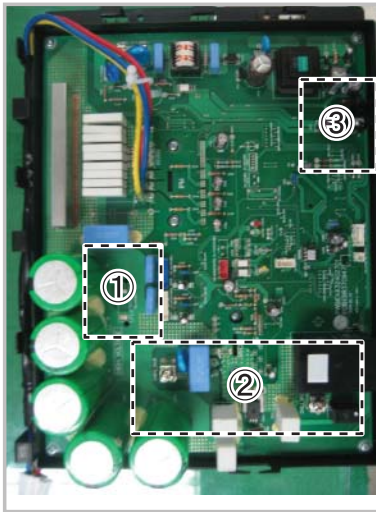

< Inverter PCB >

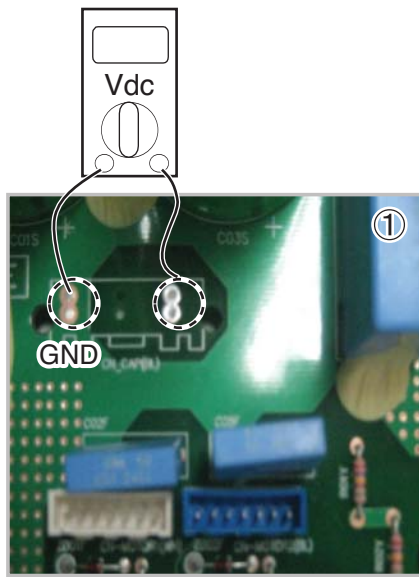

< DC Link Voltage Check Point >

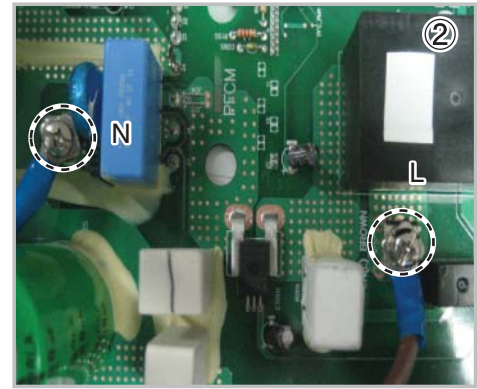

< Connection Check Point >

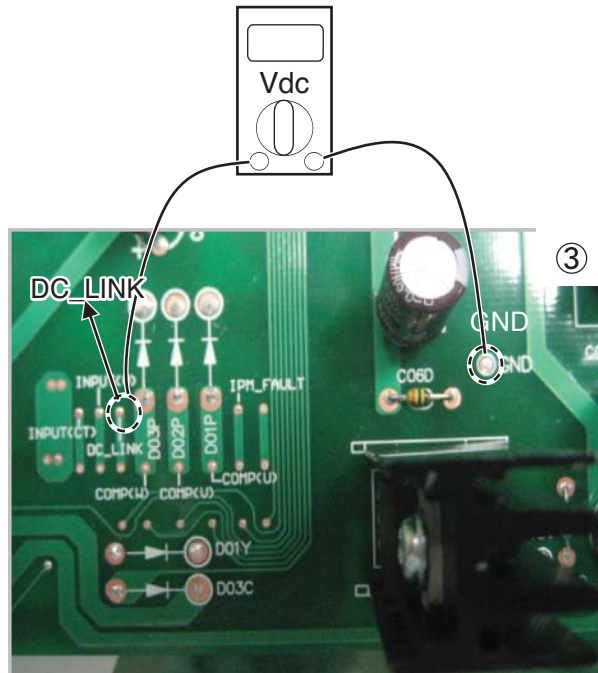

< DC_LINK Sensing Check Point >

Part 5. Trouble Shooting

Display code	Title	Cause of error	Check point & Normal condition
25	Input voltage	<ul style="list-style-type: none"> Abnormal Input voltage (140Vac , 300Vac) 	<ul style="list-style-type: none"> Check the power source. Check the components.

■ Error Diagnosis and Countermeasure Flow Chart

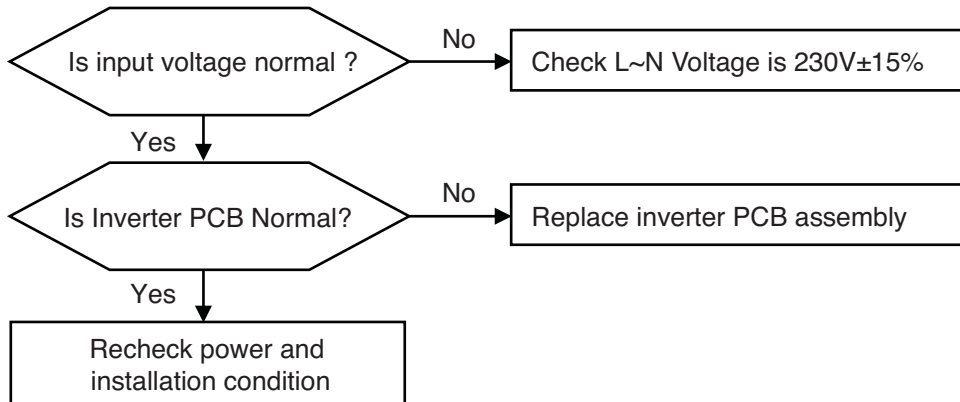

Check Point

1. Check the Input Voltage (L-N → 230V±10%)
2. Check Input Voltage Sensor output voltage (2.5Vdc±10%)

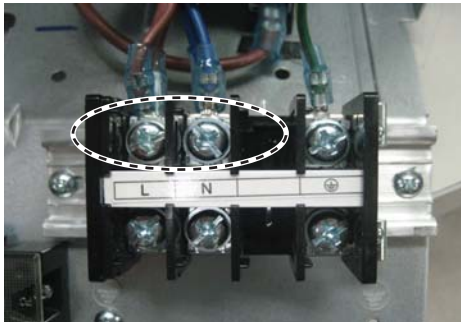

< Input Power Source Check Point >

▶ 36k

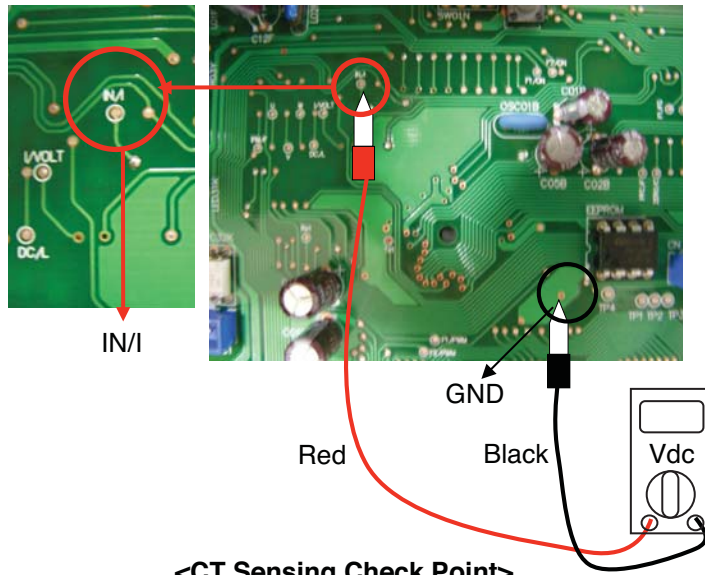
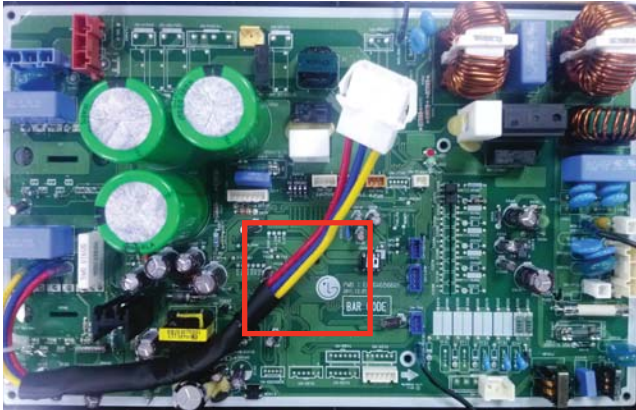

<CT Sensing Check Point>

▶ 54k



< Inverter PCB >

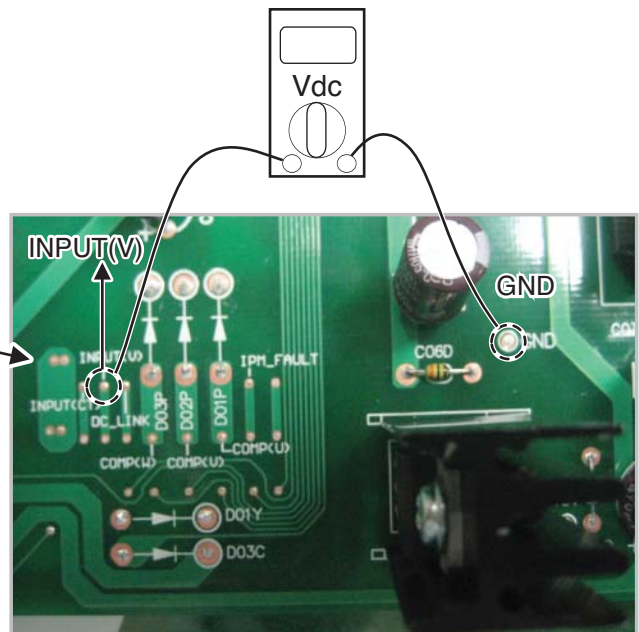

< Input Voltage Sensing Check Point >

Display code	Title	Cause of error	Check point & Normal condition
26	DC Compressor Position	<ul style="list-style-type: none"> Compressor Starting fail error 	<ul style="list-style-type: none"> Check the connection of comp wire "U,V,W" Malfunction of compressor Check the component of "IPM", detection parts.



WARNING

Before checking PCB or each outdoor electric parts, wait for 3 minutes after the power is off. When measuring at standby state of power supply, after checking the measurement mode of the meter, be careful of the short-circuits with other parts.

■ Error Diagnosis and Countermeasure Flow Chart

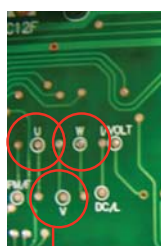
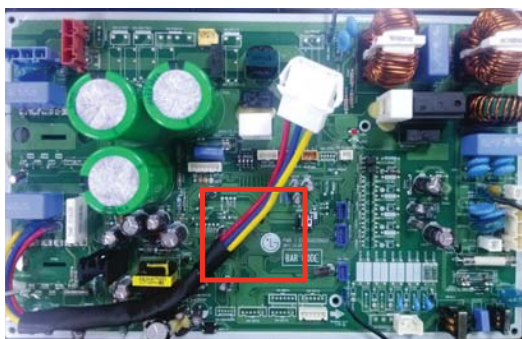
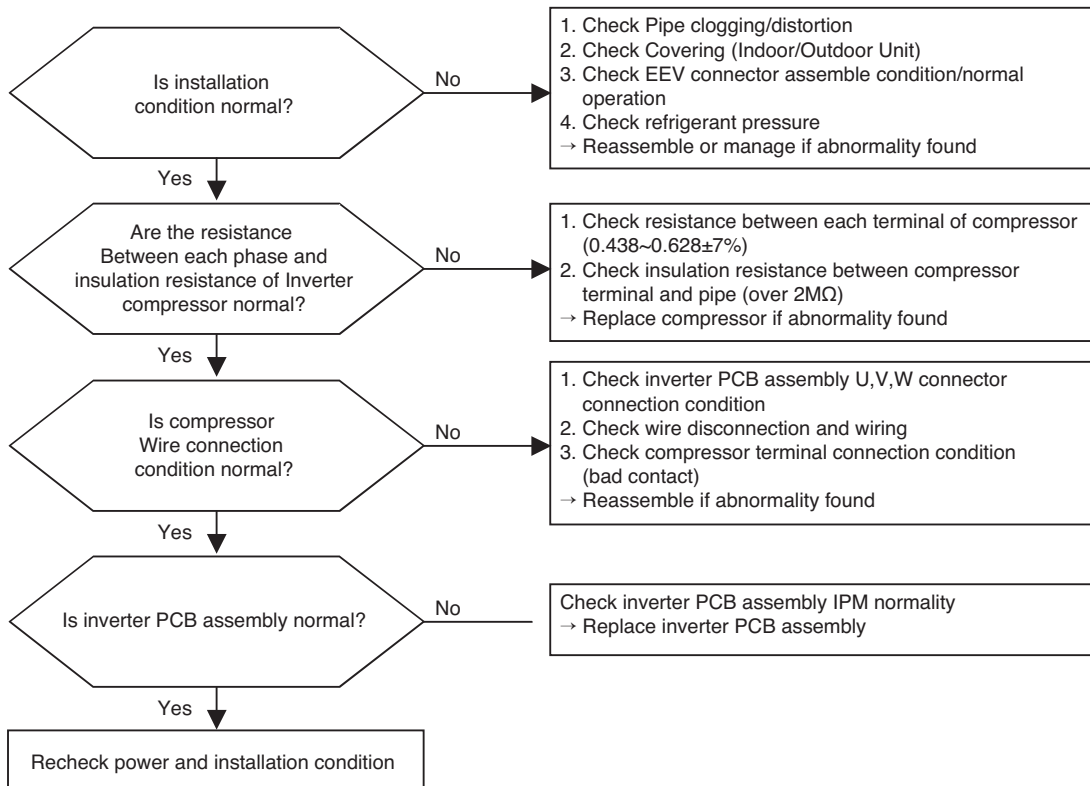

U, V, W

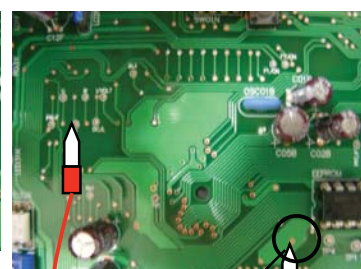

GND

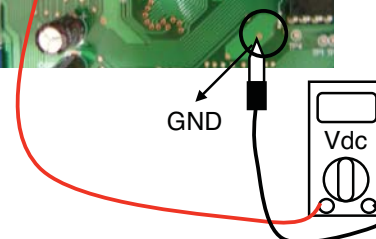

<CT Sensing Check Point>

Display code	Title	Cause of error	Check point & Normal condition
27	AC Input Instant over Current Error	Inverter PCB input current is over 100A(peak) for 2us	<ol style="list-style-type: none"> 1. Overload operation (Pipe clogging/Covering/EEV defect/Ref. overcharge) 2. Compressor damage (Insulation damage/Motor damage) 3. Input voltage abnormal (L,N) 4. Power line assemble condition abnormal 5. Inverter PCB assembly Damage (input current sensing part)

! WARNING

Before checking PCB or each outdoor electric parts, wait for 3 minutes after the power is off. When measuring at standby state of power supply, after checking the measurement mode of the meter, be careful of the short-circuits with other parts.

■ Error Diagnosis and Countermeasure Flow Chart

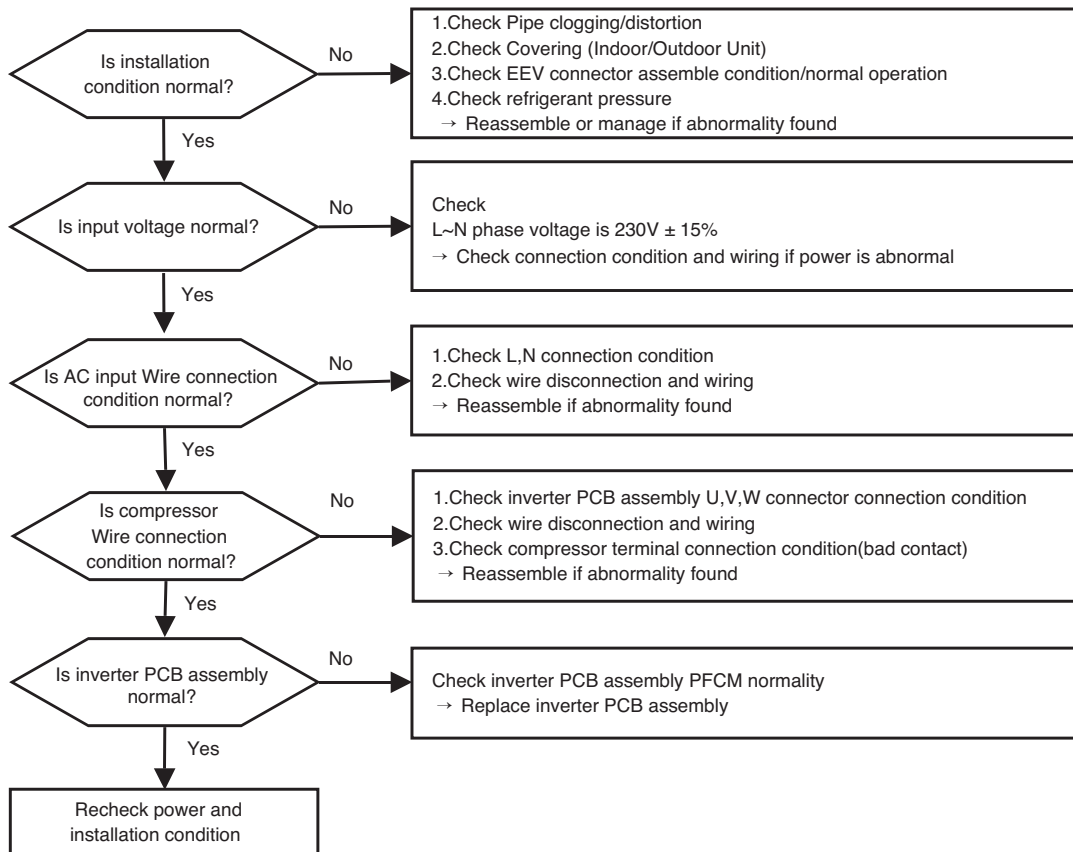

* PFCM Module checking method

- ① Set the multi tester to diode mode.
- ② Check short between input signal pin which are placed below PFC Module
- ③ Replace PCB assembly if it is short between pins except No.4,5 pins.

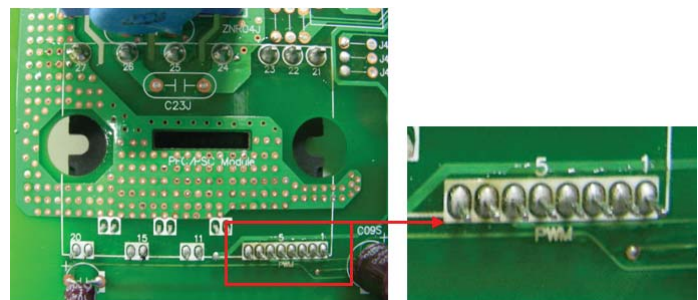

<Short Check Point>

! CAUTION

PFCM module No.4,5 pins are internal short state.

Display code	Title	Cause of error	Check point & Normal condition
29	Inverter compressor over current	Inverter compressor input current is over 30A	<ol style="list-style-type: none"> 1. Overload operation (Pipe clogging/Covering/EEV defect/Ref. over-charge) 2. Compressor damage(Insulation damage/Motor damage) 3. Input voltage low 4. ODU inverter PCB assembly damage



WARNING

Before checking PCB or each outdoor electric parts, wait for 3 minutes after the power is off. When measuring at standby state of power supply, after checking the measurement mode of the meter, be careful of the short-circuits with other parts.

■ Error Diagnosis and Countermeasure Flow Chart

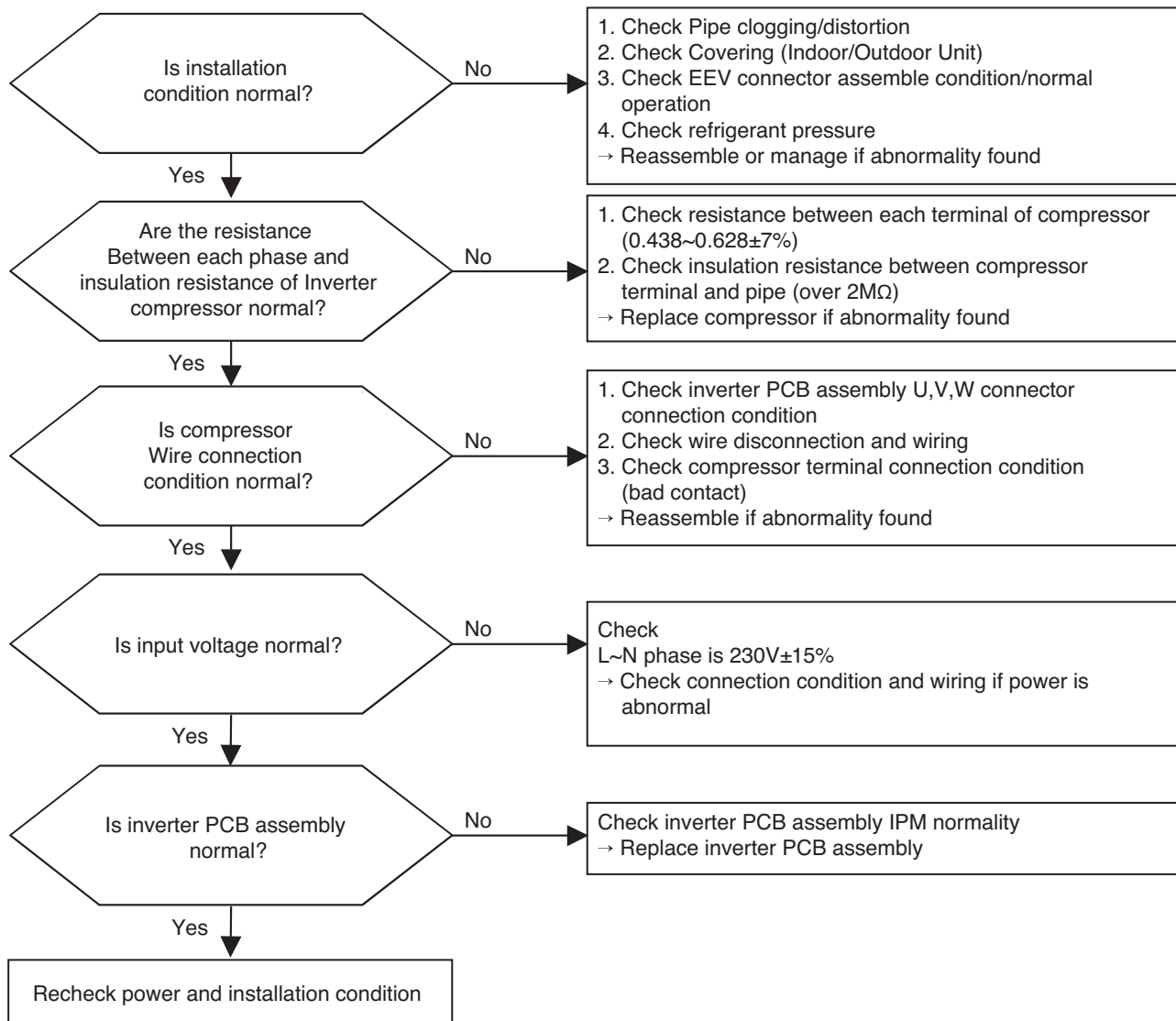

Display code	Title	Cause of error	Check point & Normal condition
32	High temperature in Discharge pipe of the inverter compressor	<ul style="list-style-type: none"> • Overload operation (Outdoor fan constraint, screened, blocked) • Refrigerant leakage (insufficient) • Poor INV Comp Discharge sensor • LEV connector displaced / poor LEV assembly 	<ul style="list-style-type: none"> • Check outdoor fan constraint/ screened/ flow structure • Check refrigerant leakage • Check if the sensor is normal • Check the status of EEV assembly



WARNING

Before checking PCB or each outdoor electric parts, wait for 3 minutes after the power is off. When measuring at standby state of power supply, after checking the measurement mode of the meter, be careful of the short-circuits with other parts.

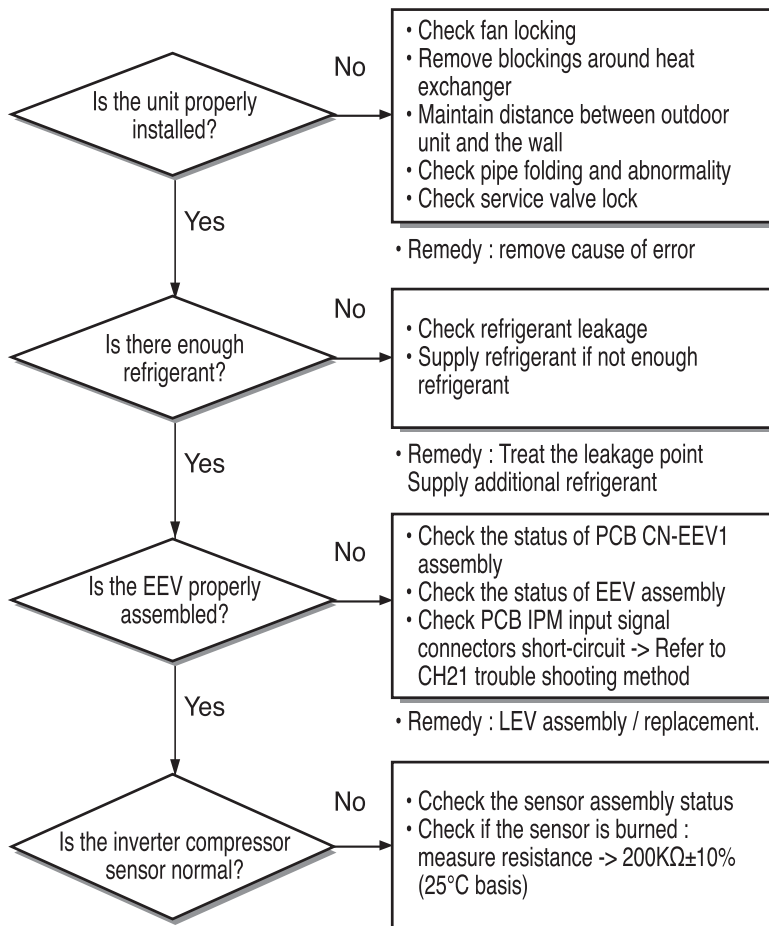

Inspecting Inverter Compressor Discharge Sensor

1. Set Multi-tester as resistance measurement mode.
2. Measure the resistance between inverter discharge sensor connector pins.
3. Measure resistance value of $200K\Omega \pm 10\%$, $25^{\circ}C$ basis
4. Check if the sensor insulation is damaged. -> measure the resistance between sensor connector pin and unit assembly pipe. ($1M\Omega$ or more)

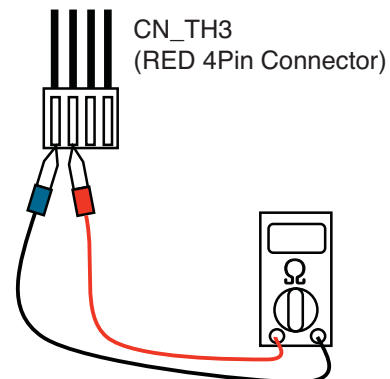

Display code	Title	Cause of error	Check point & Normal condition
35	Low Presser Error	Excessive decrease of low pressure	<ul style="list-style-type: none"> • Defective low pressure sensor • Defective outdoor/indoor unit fan • Refrigerant shortage/leakage • Deformation because of damage of refrigerant pipe • Defective indoor / outdoor unit EEV • Covering / clogging (outdoor unit covering during the cooling mode / indoor unit filter clogging during heating mode) • SVC valve clogging • Defective outdoor unit PCB • Defective indoor unit pipe sensor

■ Error diagnosis and countermeasure flow chart

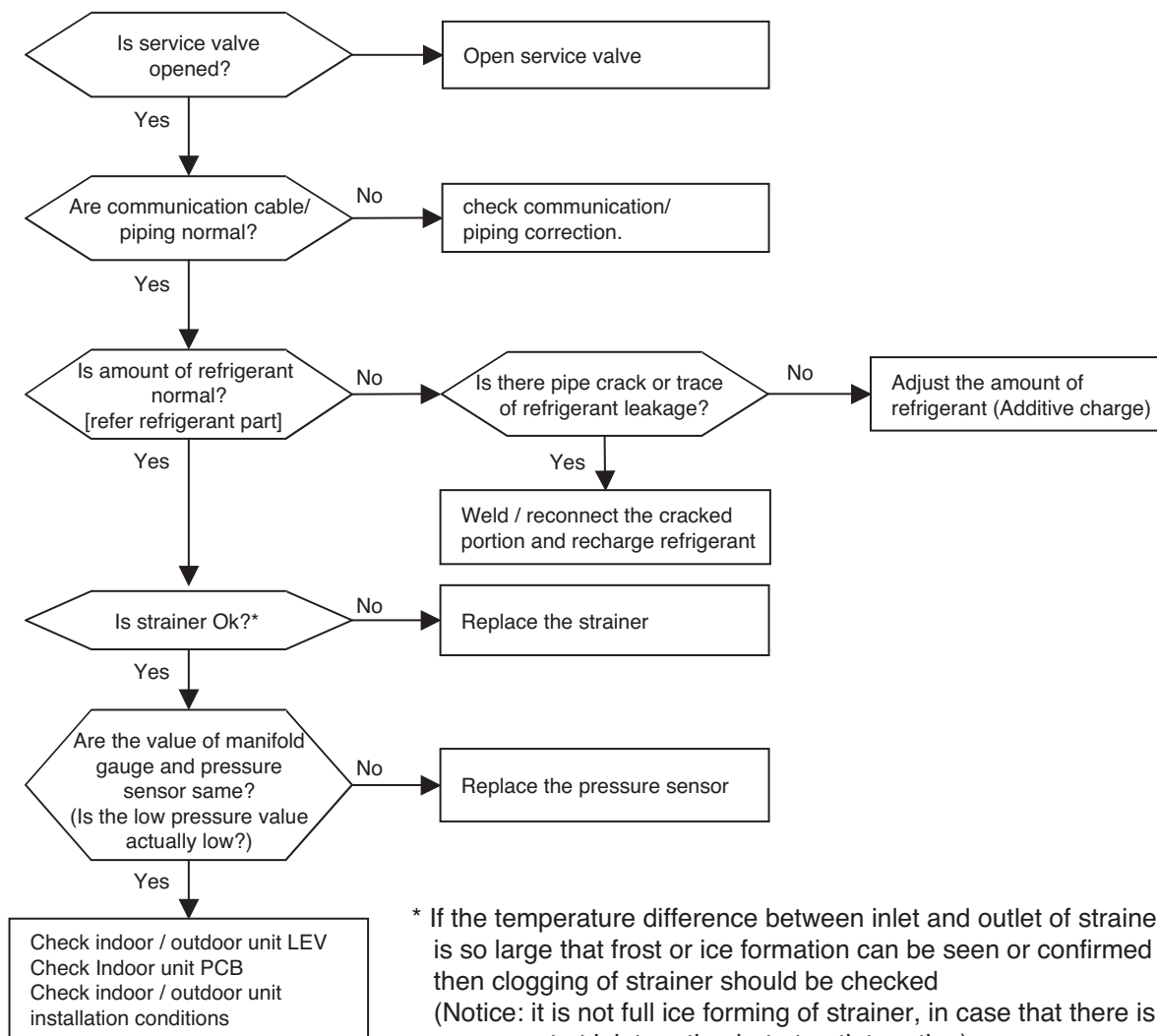

Display code	Title	Cause of error	Check point & Normal condition
39	Transmission Error Between (PFC Micom → INV Micom)	Communication Error Between PFC Micom and INV Micom.	1. Micom defect/Circuit defect 2. Different Micom S/W Version 3. ODU inverter PCB assembly damage

■ Error Diagnosis and Countermeasure Flow Chart

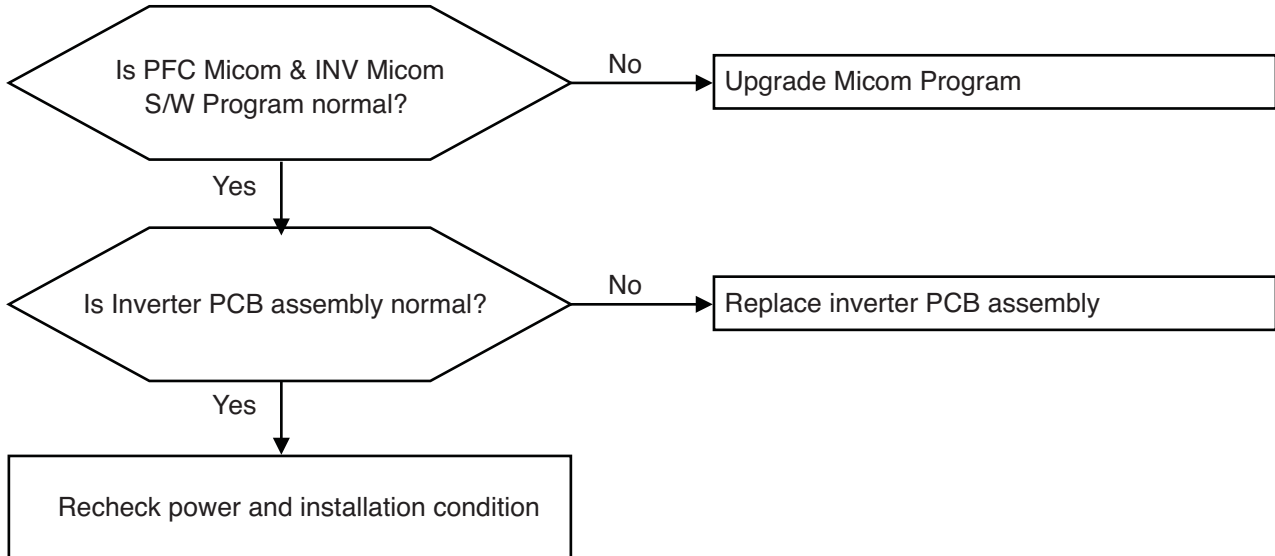

Display code	Title	Cause of error	Check point & Normal condition
40	C/T Sensor Error	<ul style="list-style-type: none"> Initial current error 	<ul style="list-style-type: none"> Malfunction of current detection circuit. (Open / Short) Check CT Sensor output voltage : 2.5Vdc \pm5%

WARNING

Before checking PCB or each outdoor electric parts, wait for 3 minutes after the power is off. When measuring at standby state of power supply, after checking the measurement mode of the meter, be careful of the short-circuits with other parts.

■ Error Diagnosis and Countermeasure Flow Chart

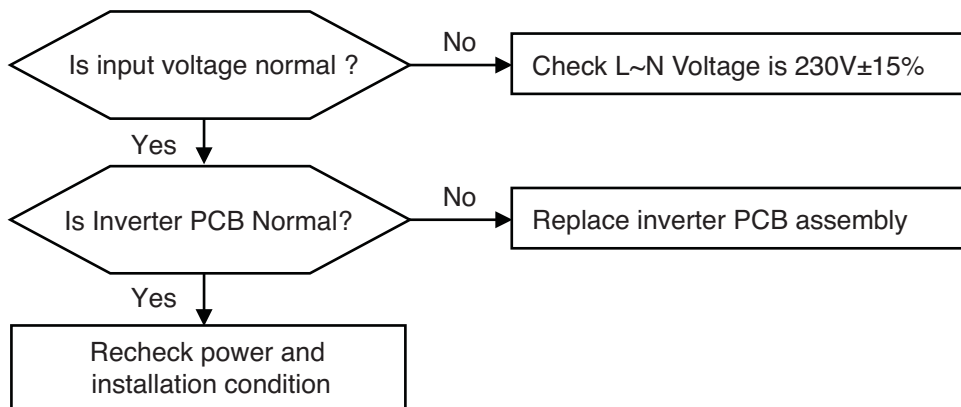

Check Point

1. Check the Input Voltage (L-N → 230V \pm 10%)
2. Check Input Voltage Sensor output voltage (2.5Vdc \pm 10%)

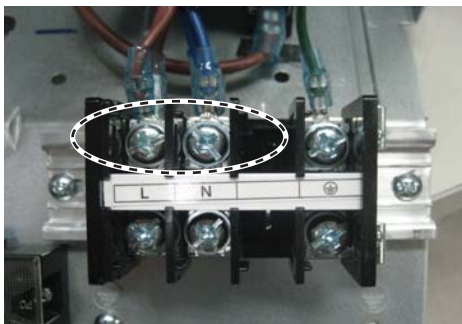

< Input Power Source Check Point >

▶ 36k

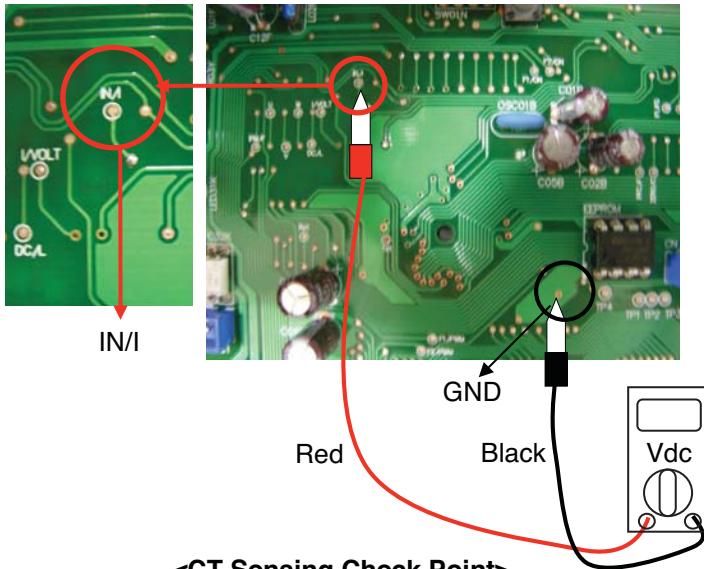
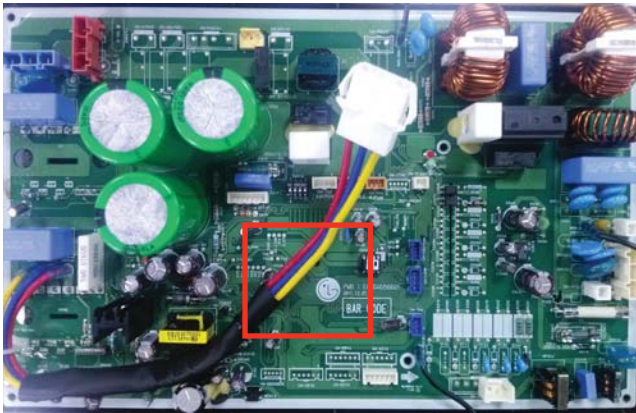

<CT Sensing Check Point>

▶ 54k



< Inverter PCB>

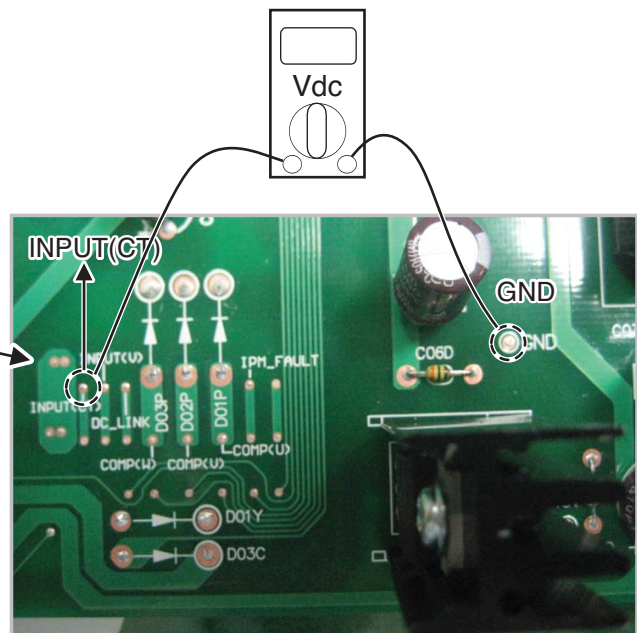

< CT Sensing Check Point >

Display code	Title	Cause of error	Check point & Normal condition
41	D-pipe sensor (Inverter)	<ul style="list-style-type: none"> • Open / Short • Soldered poorly • Internal circuit error 	<ol style="list-style-type: none"> 1. Bad connection of thermistor connector 2. Defect of thermistor connector (Open/Short) 3. Defect of outdoor PCB
44	Air sensor	<ul style="list-style-type: none"> • Open / Short • Soldered poorly • Internal circuit error 	<ol style="list-style-type: none"> 1. Bad connection of thermistor connector 2. Defect of thermistor connector (Open/Short) 3. Defect of outdoor PCB
45	Condenser Mid-pipesensor	<ul style="list-style-type: none"> • Open / Short • Soldered poorly • Internal circuit error 	<ol style="list-style-type: none"> 1. Bad connection of thermistor connector 2. Defect of thermistor connector (Open/Short) 3. Defect of outdoor PCB
46	Suction Pipe sensor	<ul style="list-style-type: none"> • Open / Short • Soldered poorly • Internal circuit error 	<ol style="list-style-type: none"> 1. Bad connection of thermistor connector 2. Defect of thermistor connector (Open/Short) 3. Defect of outdoor PCB
48	Condenser Out-pipe sensor	<ul style="list-style-type: none"> • Open / Short • Soldered poorly • Internal circuit error 	<ol style="list-style-type: none"> 1. Bad connection of thermistor connector 2. Defect of thermistor connector (Open/Short) 3. Defect of outdoor PCB

■ Error Diagnosis and Countermeasure Flow Chart

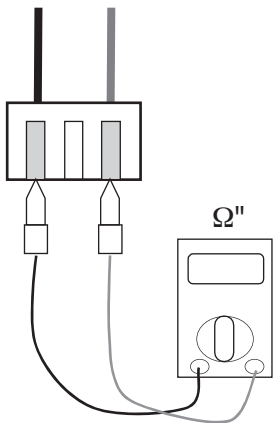
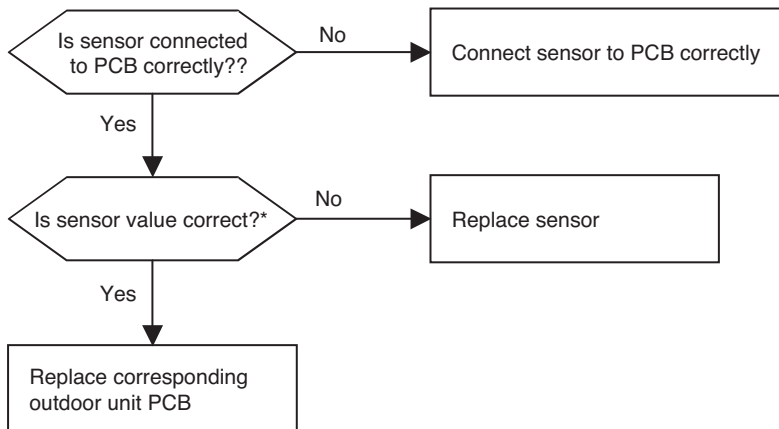

Check Point

1. Estimate the resistance of each sensor.(Unplugged)
2. Check the value of the resistor of thermistor.

D-pipe sensor (Inverter)	: Normal Value of the resistor is 200kΩ at 25°C
Air sensor	: Normal Value of the resistor is 10kΩ at 25°C
Cond. Mid-pipe sensor	: Normal Value of the resistor is 5kΩ at 25°C
Suction pipe sensor	: Normal Value of the resistor is 5kΩ at 25°C
Condenser Out-pipe sensor	: Normal Value of the resistor is 5kΩ at 25°C

Display code	Title	Cause of error	Check point & Normal condition
43	Sensor error of high pressure	Abnormal value of sensor (Open/Short)	<ul style="list-style-type: none"> • Bad connection of connector PCB • Bad connection high pressure connector • Defect of high pressure connector (Open/Short) • Defect of connector PCB (Open/Short) • Defect of outdoor main PCB.

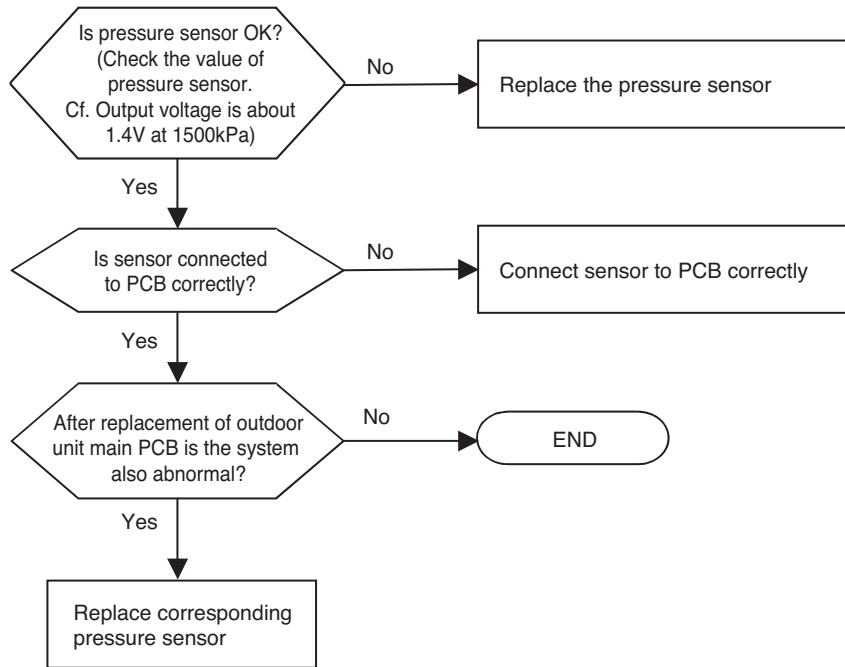

Display code	Title	Cause of error	Check point & Normal condition
51	Over capacity	• Over capacity Combination	• Check the indoor unit capacity. • Check the combination table.

Model	Gross max.capacity	Max.single indoor unit capacity
A4UW36GFA0	48k	24k
A8UW54GFA0	73k	36k

Check Point

• CH 51

1. Check the indoor unit capacity.
2. Check the combination table.

Display code	Title	Cause of error	Check point & Normal condition
53	Title Communication (Indoor → Outdoor)	• Communication poorly	<ul style="list-style-type: none"> • Power input AC 230V. (Outdoor, Indoor) • The connector for transmission is disconnected. • The connecting wires are misconnected. • The communication line is shorted at GND. • Transmission circuit of outdoor PCB is abnormal. • Transmission circuit of indoor PCB is abnormal.



WARNING

Before checking PCB or each outdoor electric parts, wait for 3 minutes after the power is off. When measuring at standby state of power supply, after checking the measurement mode of the meter, be careful of the short-circuits with other parts.

Check Point

1. Check the input power AC230V. (Outdoor, Indoor unit)
 2. Check the communication wires are correctly connected.
Adjust the connection of wire Confirm the wire of "Live", "Neutral"
 3. Check the resistance between communication line and GND. (Normal : Over 2MΩ)
 4. Check the connector for communication is correctly connected.
 5. If one indoor unit is operated normally, outdoor PCB is no problem.
Check the another indoor unit.
- * CH05 is displayed at indoor unit, CH53 is displayed at outdoor unit.
6. If all indoor unit is displayed CH05 but outdoor PCB not display
CH53 : Check the CN_COM and CN_POWER is correctly connected.

• 36k

1. In Case of CH53, Check the Connection
→ L,N at the terminal block

• 54k

1. In Case of CH05, Check the Connection
→ CN_POWER, CN_COMM at the Main PCB
2. In Case of CH53, Check the Connection
→ CN_COMM at the Main PCB → L, N at the terminal block

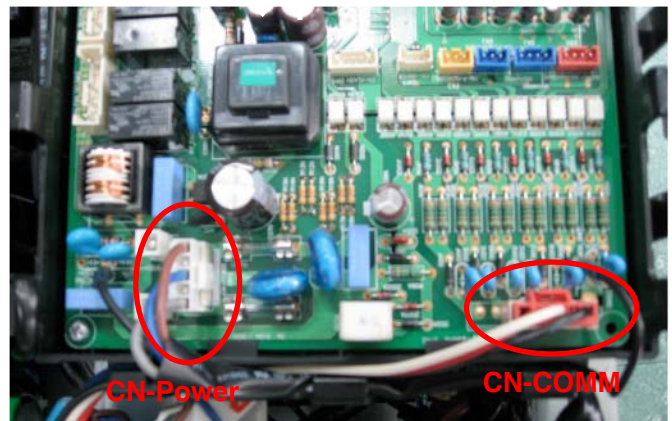

< MAIN PCB >



< TERMINAL BLOCK >

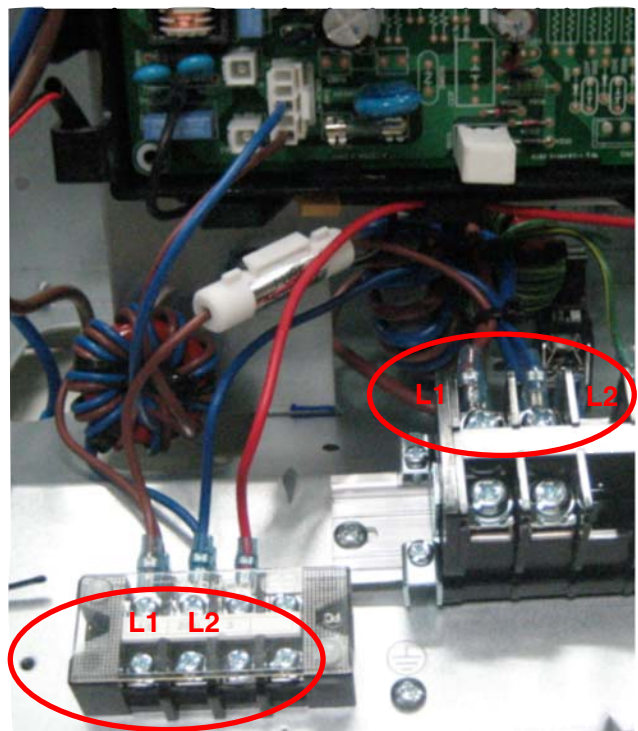

Display code	Title	Cause of error	Check point & Normal condition
60	Inverter PCB & Main EEPROM check sum error	EEPROM Access error and Check SUM error	1. EEPROM contact defect/wrong insertion 2. Different EEPROM Version 3. ODU Inverter & Main PCB assembly damage

! WARNING

Before checking PCB or each outdoor electric parts, wait for 3 minutes after the power is off. When measuring at standby state of power supply, after checking the measurement mode of the meter, be careful of the short-circuits with other parts.

■ Error Diagnosis and Countermeasure Flow Chart

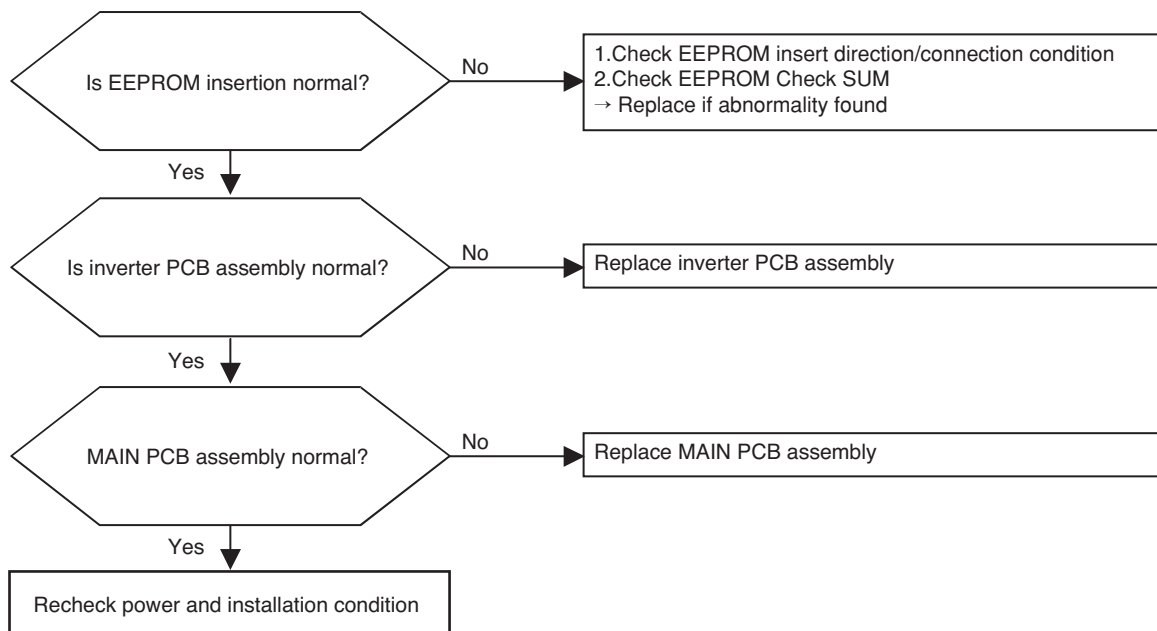

Check Point

- Check the EEPROM Check sum & Direction

▶ 36k

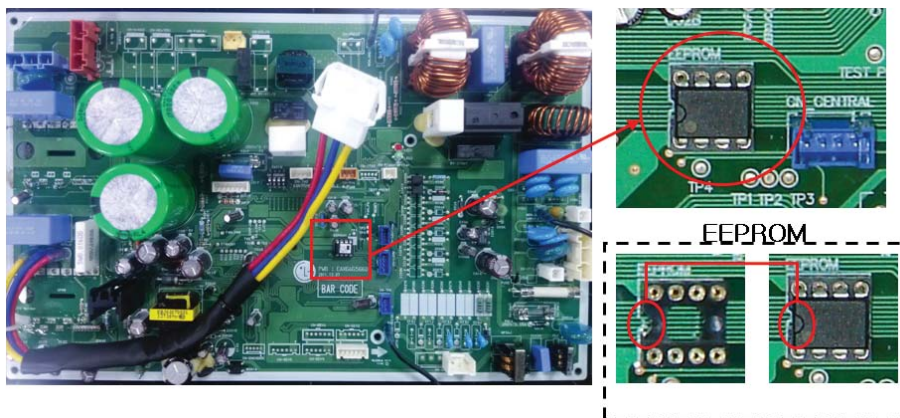

▶ 54k



<Inverter PCB>

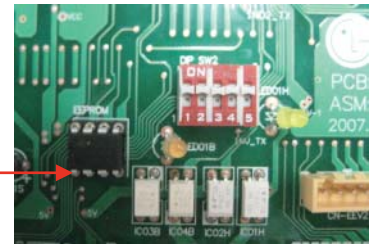

<MAIN PCB>

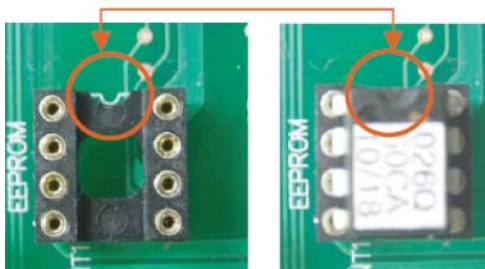

<EEPROM Direction Check Point>

Display code	Title	Cause of error	Check point & Normal condition
61	High temperature in outdoor Cond. Pipe	<ul style="list-style-type: none"> • Overload operation (Outdoor fan constraint, screened, blocked) • Outdoor unit heat exchanger contaminated • EEV connector displaced / poor EEV assembly • Poor Cond. Pipe sensor assembly / burned 	<ul style="list-style-type: none"> • Check outdoor fan constraint / screened / flow structure • Check if refrigerant overcharged • Check the status of EEV assembly • Check the status of sensor assembly / burn



WARNING

Before checking PCB or each outdoor electric parts, wait for 3 minutes after the power is off. When measuring at standby state of power supply, after checking the measurement mode of the meter, be careful of the short-circuits with other parts.

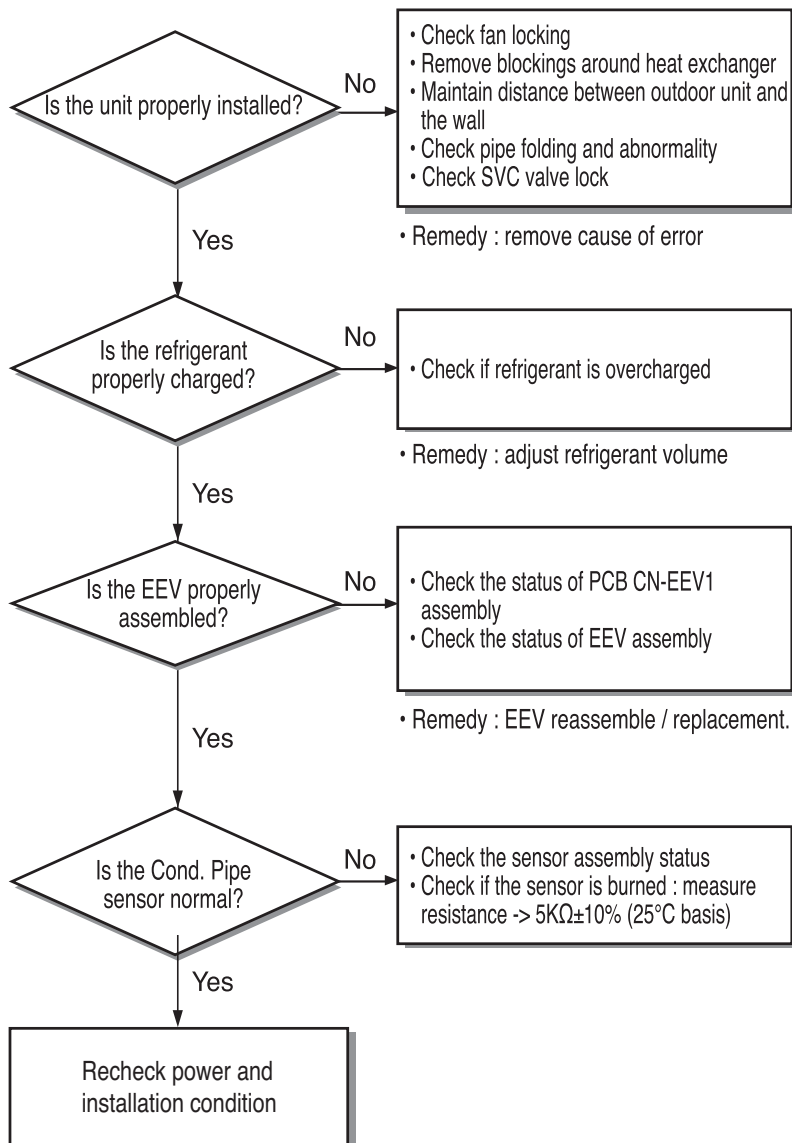

Inspecting Cond. Pipe Sensor

1. Set Multi-tester as resistance measurement mode.
2. Measure the resistance between rated speed Comp Discharge sensor connector pins.
3. Measure resistance value of $5k\Omega \pm 10\%$, 25°C basis
4. Check if the sensor insulation is damaged. -> measure the resistance between sensor connector pin and unit assembly pipe. (1MΩ or more)

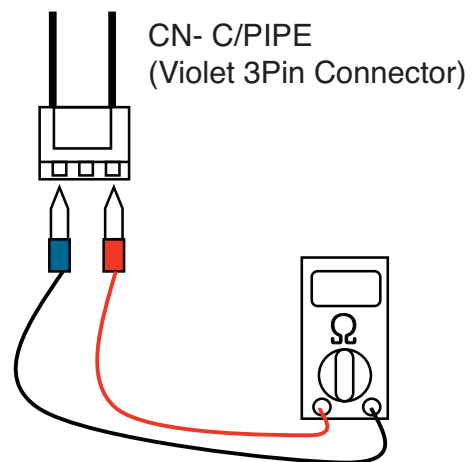

Display code	Title	Cause of error	Check point & Normal condition
62	Heatsink High error	Inverter PCB heatsink temperature is over 85°C	1. ODU fan locking 2. Heatsink assembly of INV PCB assemble condition abnormal 3. Defect of temperature sensing circuit part defect of INV PCB

■ Error Diagnosis and Countermeasure Flow Chart

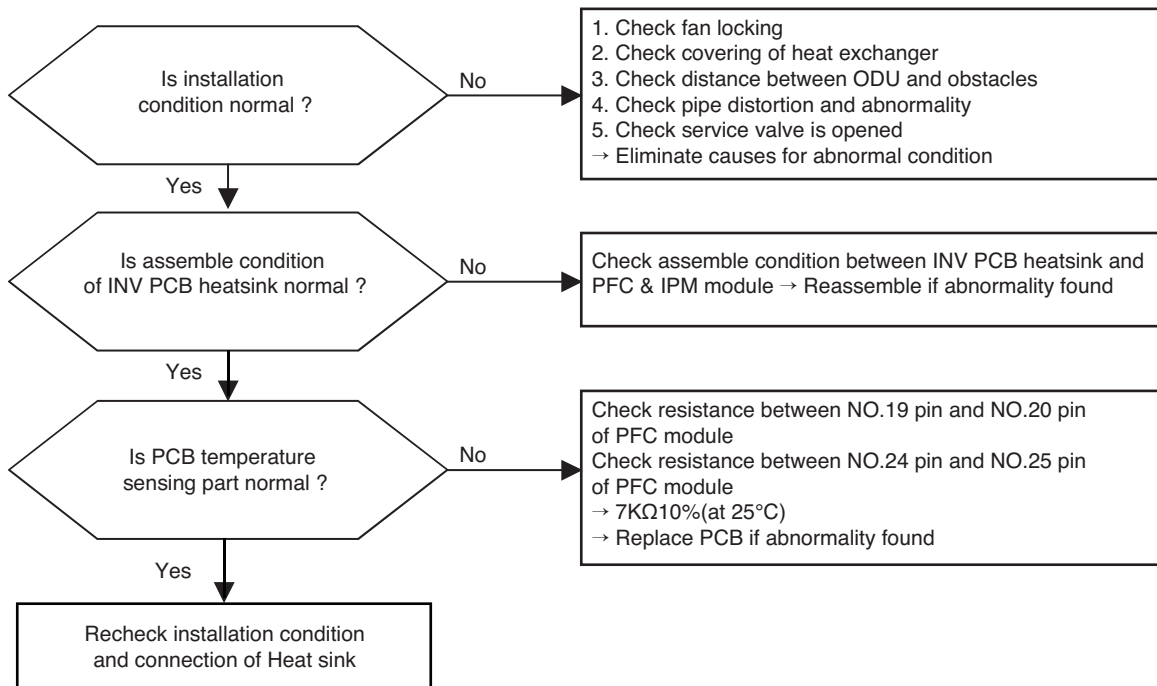

Check Point

1. Check resistance between No.19 pin and NO.20 pin of PCB PFC module
2. Check resistance between No.24 pin and NO.25 pin of PCB PFC module - only 48/56k
3. Resistance value should be in $7k\Omega \pm 10\%$.(at 25°C).

▶ 36k

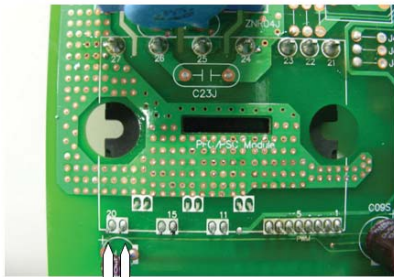

PFCM :
Measuring resistance
between No.19,20 pin

▶ 54k

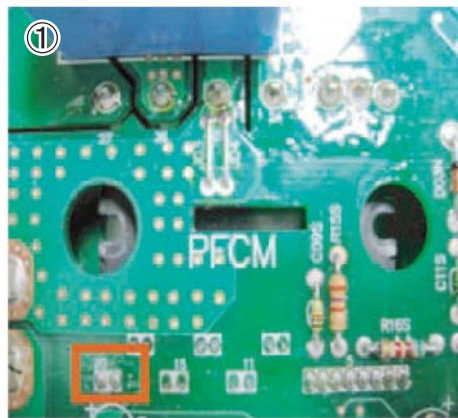
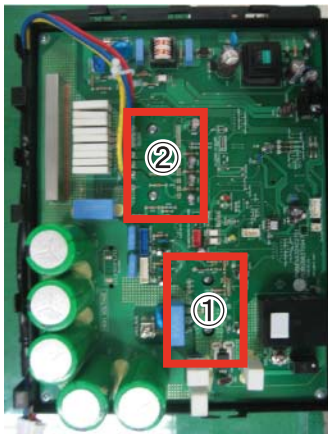

IPM :
Measuring resistance
between No.19,20 pin

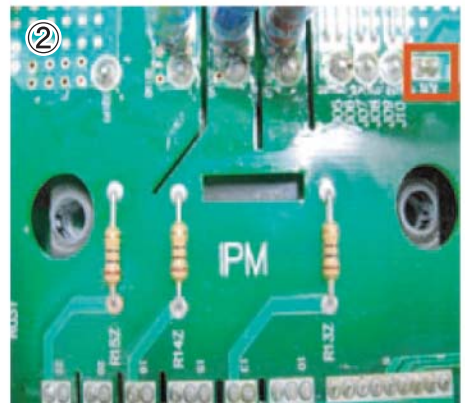

IPM :
Measuring resistance
between No.24,25 pin

Display code	Title	Cause of error	Check point & Normal condition
65	Heatsink Sensor error	Inverter PCB heatsink sensor is open or short	1. ODU fan locking 2. Heatsink assembly of INV PCB assemble condition abnormal 3. Defect of temperature sensing circuit part defect of INV PCB

■ Error Diagnosis and Countermeasure Flow Chart

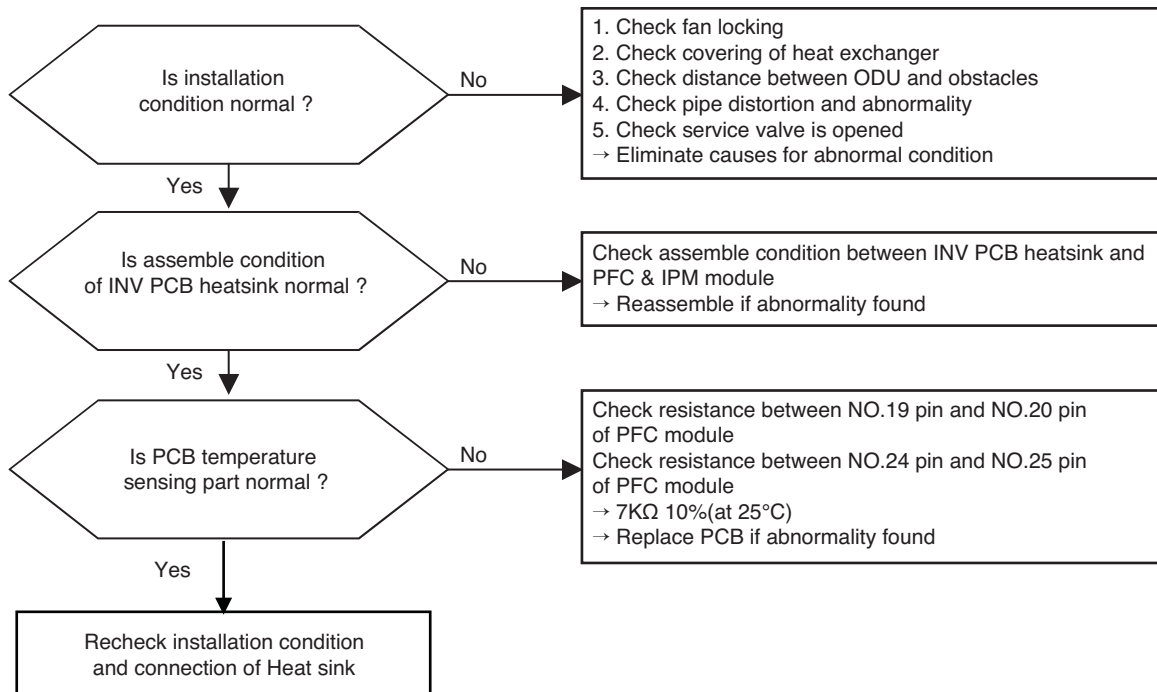

Check Point

1. Check resistance between No.19 pin and NO.20 pin of PCB PFC module
2. Check resistance between No.24 pin and NO.25 pin of PCB PFC module - only 48/56k
3. Resistance value should be in $7k\Omega \pm 10\%$.(at 25°C).
4. Check the PFC Module No.19, 20 and IPM Module No.24, 25 pin soldering condition.

▶ 36k

Location of SPM /PSCM /PFCM

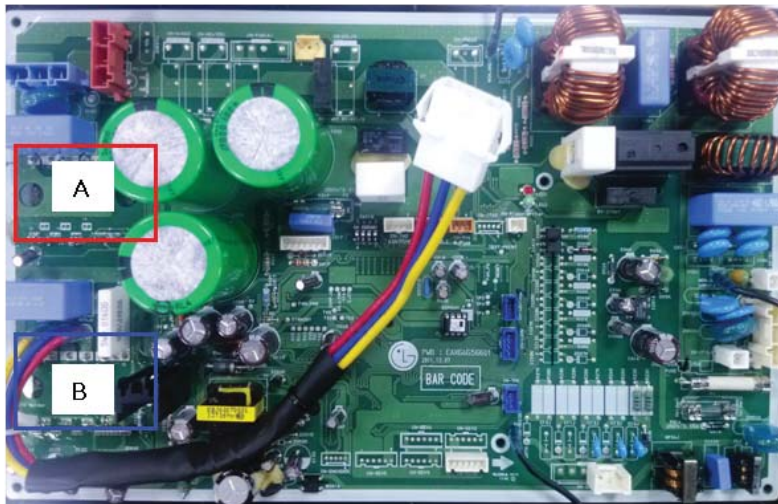

A: PSCM /PFCM

B: SPM

▶ 54k

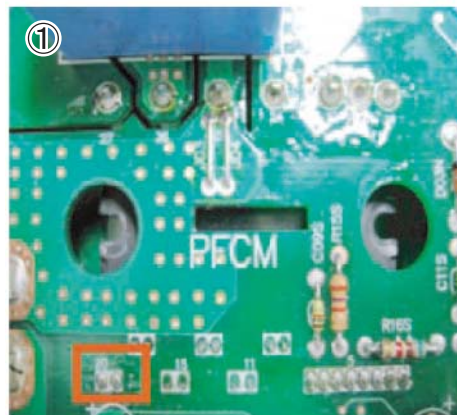
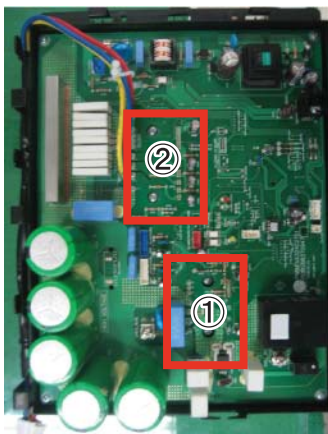

PFCM :
Measuring resistance
between No.19,20 pin

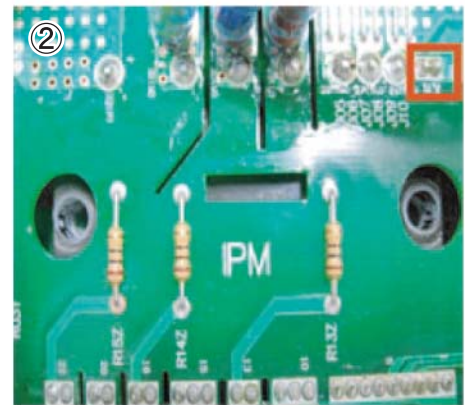

IPM :
Measuring resistance
between No.24,25 pin

Display code	Title	Cause of error	Check point & Normal condition
67	Fan Lock Error	Fan RPM is 10RPM or less for 5 sec. when ODU fan starts or 40 RPM or less after fan starting.	1. ODU fan locking 2. Heatsink assembly of INV PCB assemble condition abnormal 3. Defect of temperature sensing circuit part defect of INV PCB

■ Error Diagnosis and Countermeasure Flow Chart

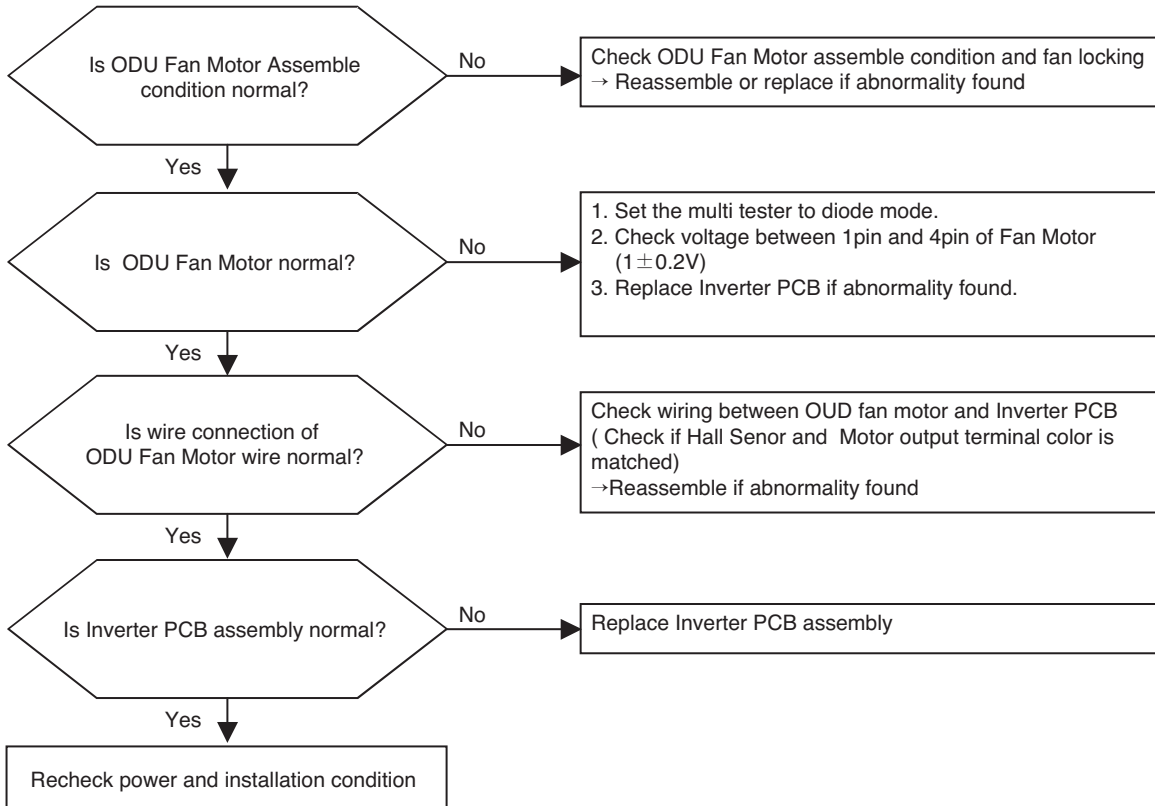

Check Point

1. Check voltage between 1pin and 4pin of Fan Mortor connector (Tester diode mode)
2. Voltage value should be in $1V \pm 0.2V$.
3. Do not replacing all of fan motor and PCB at once.
Check error code again, after replacing the abnormal part (Fan Motor or PCB) first.

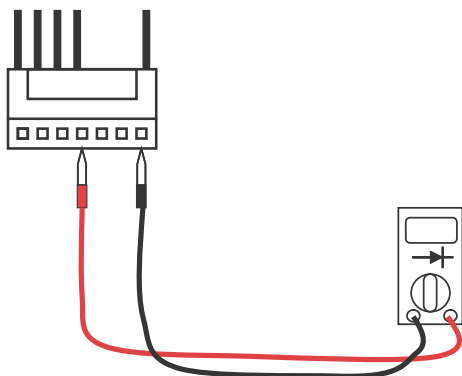

▶ 36k

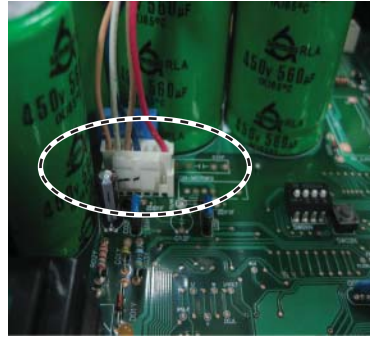
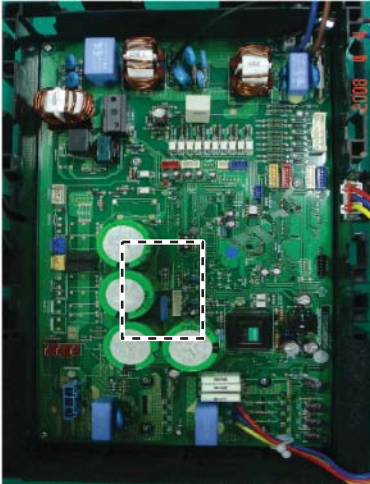

<Main PCB>

Check voltage between
1pin and 4pin of fan motor

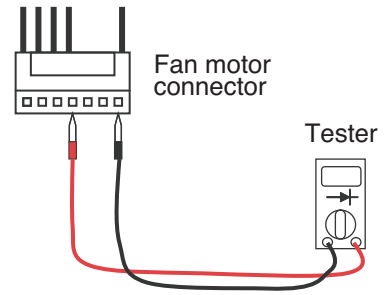

▶ 54k

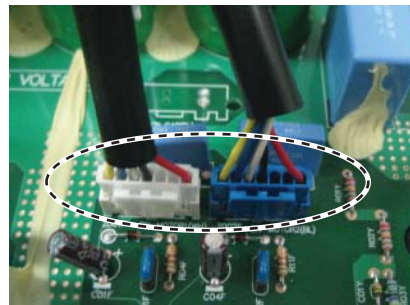
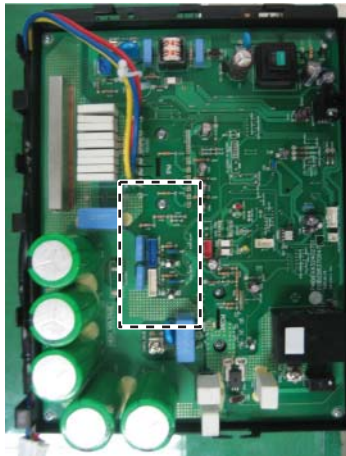

<Inverter PCB>

Display code	Title	Cause of error	Check point & Normal condition
73	AC input instant over current error (Matter of software)	Inverter PCB input power current is over 48A(peak) for 2ms	<ol style="list-style-type: none"> 1. Overload operation (Pipe clogging/Covering/EEV defect/Ref.overcharge) 2. Compressor damage (Insulation damage/Motor damage) 3. Input voltage abnormal (L, N) 4. Power line assemble condition abnormal 5. Inverter PCB assembly damage (input current sensing part)

■ Error Diagnosis and Countermeasure Flow Chart

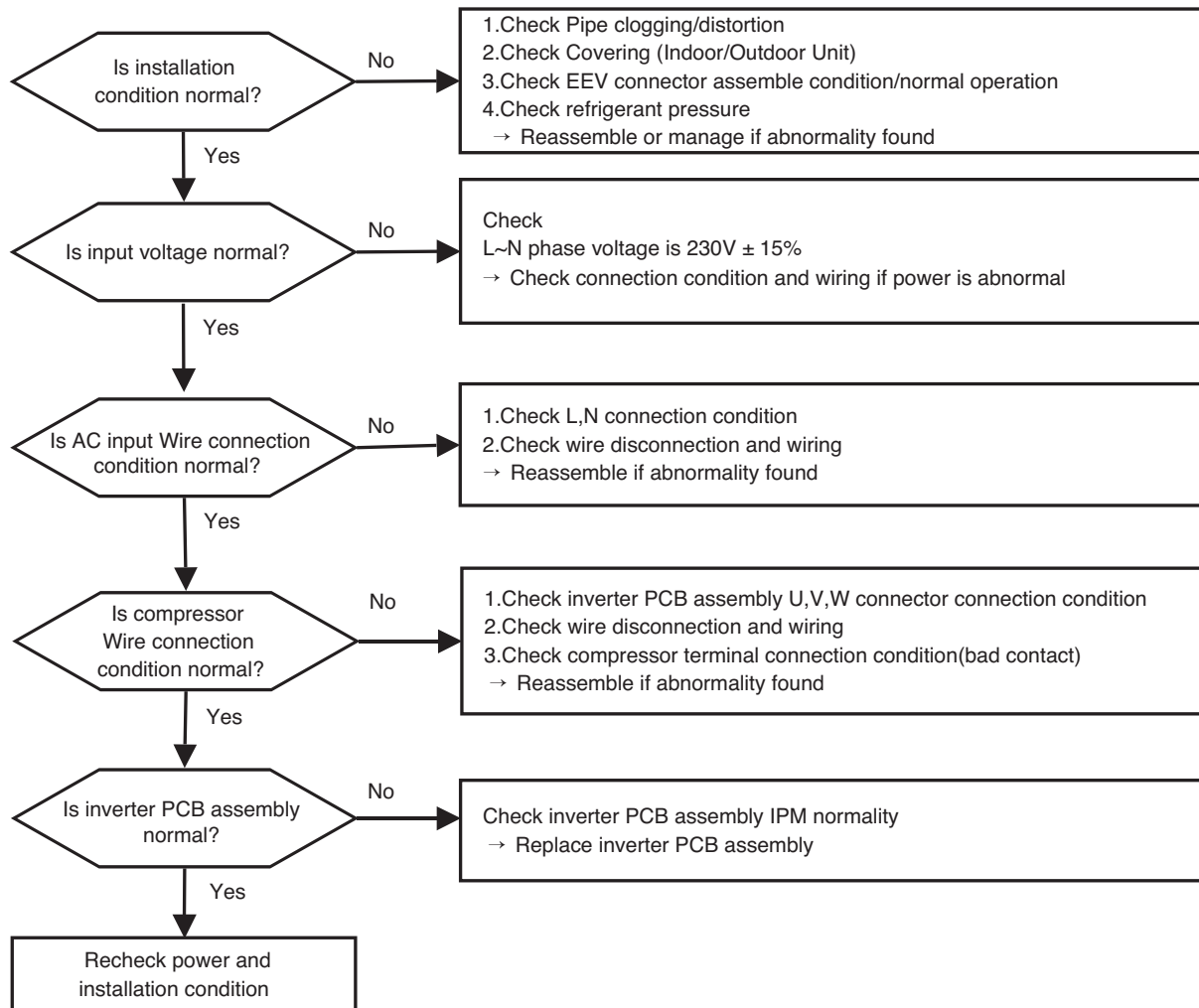

▶ 36k

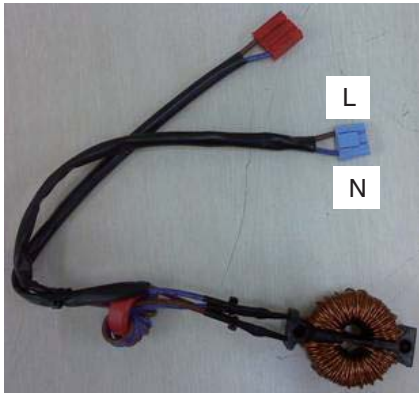

< Noise Filter wiring Check Point >

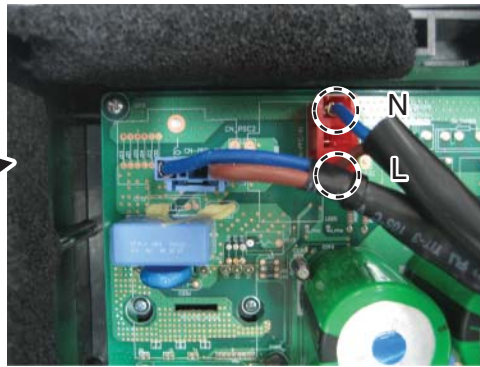
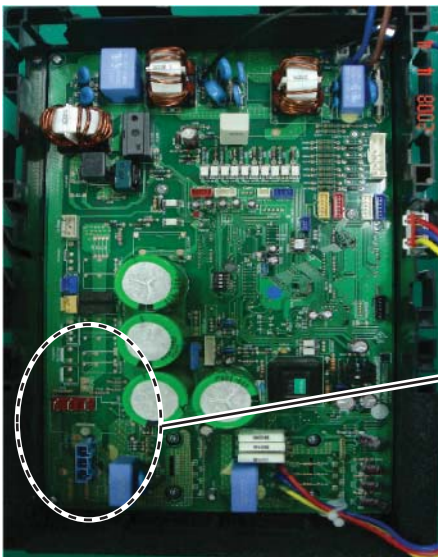

< Main PCB wiring Check Point >

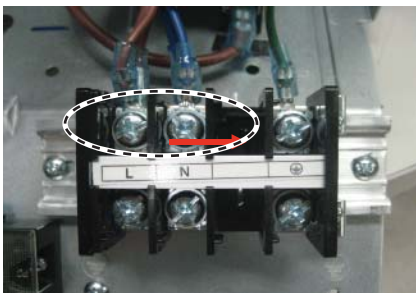

< Input Power Source Check Point >

▶ 54k

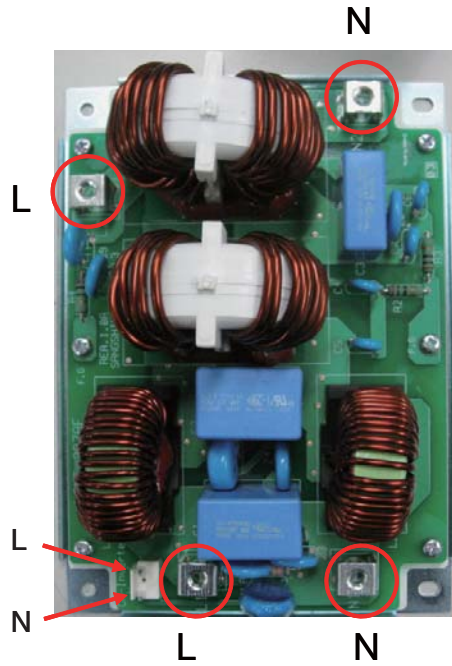

< Noise Filter wiring Check Point >

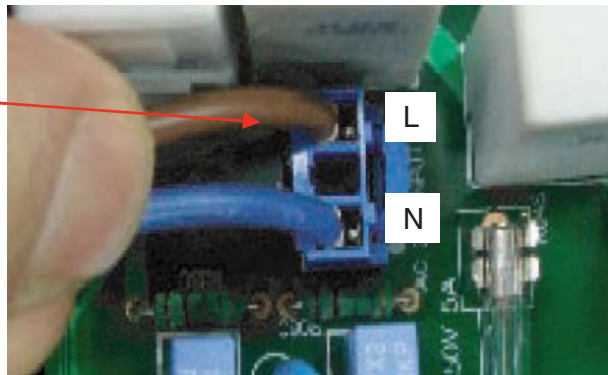
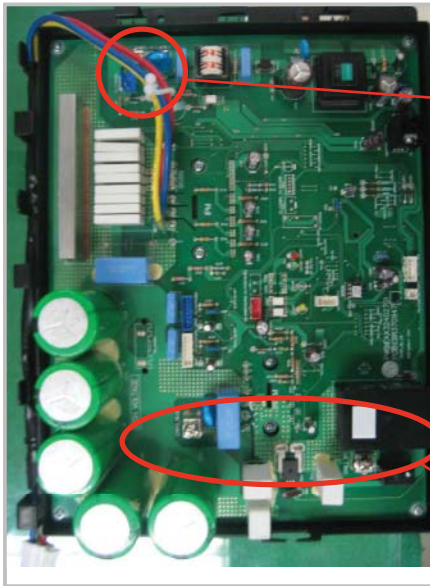

< Input Power Source Check Point >

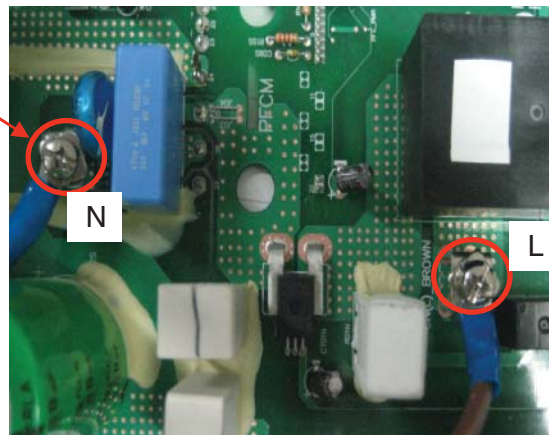

< Inverter PCB wiring Check Point >

Part 6. Service Order

1. PCB Service Order111

1. PCB Service Order

▶ A2UW18GFA0/A3UW24GFA0

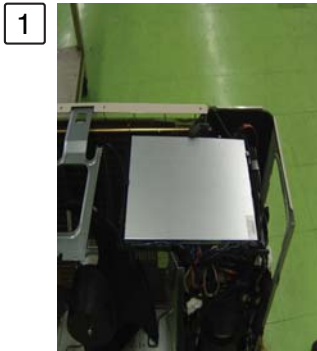

Remove Top Cover and Control Box Cover

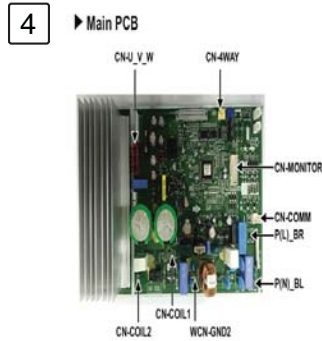

Take Terminals from PCB with a tool

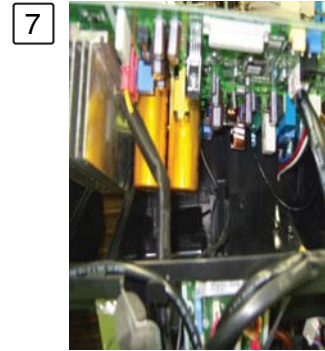

Hang wires up on the Rib from Case and Insert PCB into Control Box

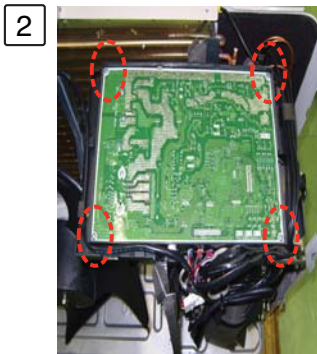

Remove PCB Screws (6ea)

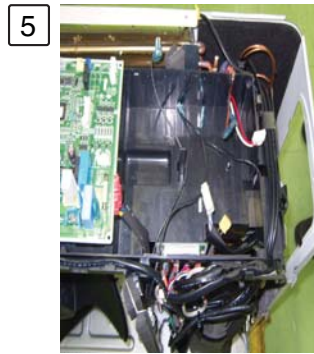

Replace New PCB

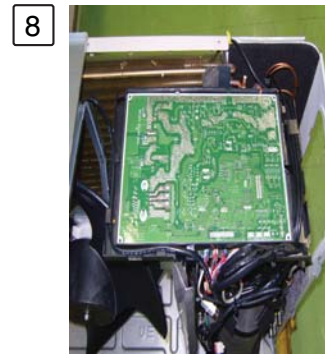

Tighten PCB Screws (6ea)

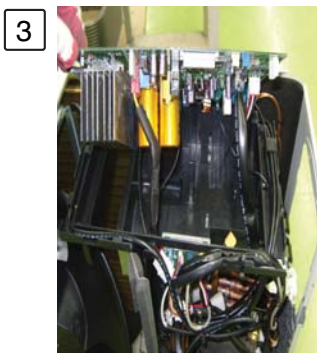

Raise PCB and take terminals from PCB

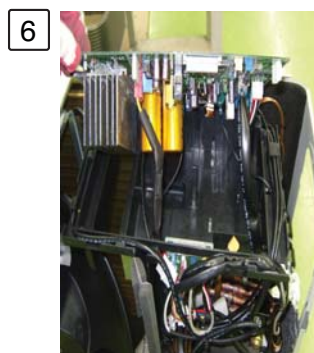

Re-wire terminal

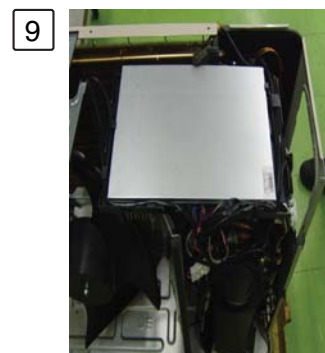

Assemble C/Box and Top Cover into a complete whole



P/NO : MFL68280201

January, 2014