

Split Air Conditioner

OWNER'S MANUAL

AIR CONDITIONERS

Thank you for choosing DE'LONGHI air conditioner. For correct operation, please read this owner's manual carefully before operating the unit and keep it carefully for consultation.

◆ CONTENTS

Operation and maintenance

■ Notices for operation	1
■ Notices for use	3
■ Names and functions of each part	4
■ Operation of wireless remote control	5
■ Emergency operation	10
■ Clean and care	12
■ Troubleshooting	15

Installation service

■ Notices for installation	18
■ Installation dimension diagram	20
■ Install indoor unit	21
■ Install outdoor unit	23
■ Check after installation and test operation	24
■ Installation and Maintenance of Healthy Filter	25



This symbol stands for the items should be forbidden.



This symbol stands for the items should be followed

Thank you for choosing De' Longhi air conditioner, please read this owner's manual carefully before operating the unit and keep it carefully for consultation.

This appliance is not intended for use by persons (including children) with reduced physical, sensory or mental capabilities or lack of experience and knowledge, unless they have been given supervision or instruction concerning use of the appliance by a person responsible for their safety.

Children should be supervised to ensure that they do not play with the appliance.



Do not dispose this product as unsorted municipal waste. Collection of such waste separately for special treatment is necessary.

◆ Operation and maintenance-notice for operation

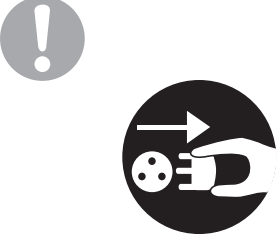
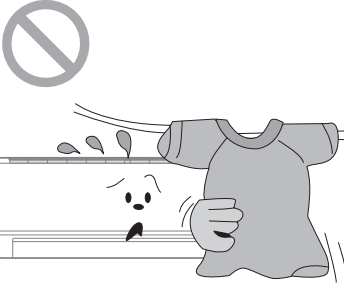
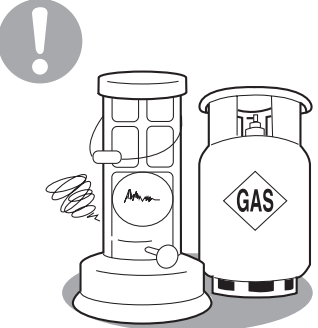
<p>⚠ ★ Earth: The ground be connected!</p>  <p>If not, please ask the qualified personnel to install. Furthermore, don't connect each wire to the gas pipe, water pipe, drainage pipe or any other improper places.</p>	<p>★ Be sure to pull out the power plug when not using the air conditioner for a long time.</p>  <p>Otherwise, the accumulated dust may cause fire or electric shock.</p>	<p>★ Select the most appropriate temperature.</p>  <p>Keep room cooler than outside about 5 degree.</p> <p>It can preclude the electricity wasted.</p>
<p>★ Don't leave windows and doors open for a long time while operating the air conditioner.</p>  <p>It can decrease the air conditioning capacity.</p>	<p>★ Don't block the air intake or outlet vents of both the outdoor and indoor units.</p>  <p>It can decrease the air conditioning capacity or cause a malfunction.</p>	<p>★ Keep combustible spray away from the units more than 1m.</p>  <p>It can cause a fire or explosion.</p>
<p>★ The power supply must adopt the special circuit that with air switch protection and assure it has enough capacity.</p> <p>The unit will be turned on or off according to your requirement automatically, please do not turn on or turn off the unit frequently, otherwise disadvantage effect may be caused to the unit.</p>	<p>⊘ ★ Never splice the power cord or use an extended cord.</p>  <p>It can cause overheating or fire.</p>	<p>★ Don't attempt to repair the air conditioner by yourself.</p>  <p>The wrong repair will lead to an electric shock or fire, so you should contact the service center to repair.</p>

◆ Notices for operation

- ★ If the supply cord is damaged, it must be replaced by the manufacturer or its service agent or a similarly qualified person in order to avoid a hazard.



- ★ The airflow direction can be adjusted appropriately. At operating, adjust the vertical airflow direction by adjusting the louvers of upward/downward direction. And then, hold two ends of left and right louver to adjust the horizontal airflow.

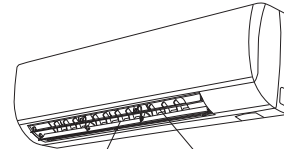

Louver of left/right direction Louver of upward/downward direction.

- ★ Don't insert your hands or stick into the air intake or outlet vents.

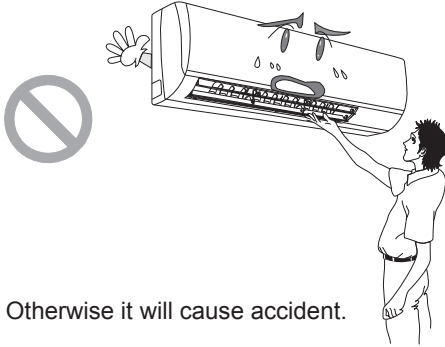

Otherwise it will cause accident.

- ★ Don't blow the wind to animals and plants directly. It can cause a bad influence to them.

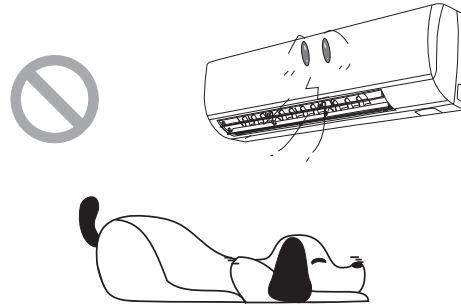

- ★ Don't apply the cold wind to the body for a long time.

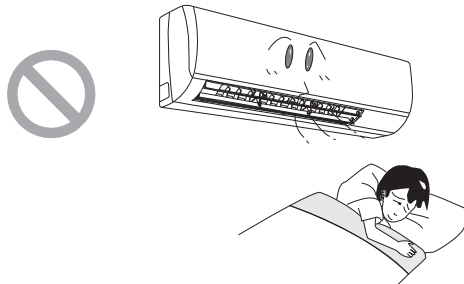

It can cause the health problems.

- ★ Don't use the air conditioner for other purposes, such as drying clothes, preserving foods, etc.

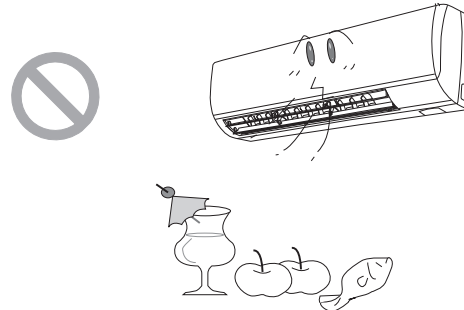

- ★ Splashing water on the air conditioner can cause an electric shock and malfunction.

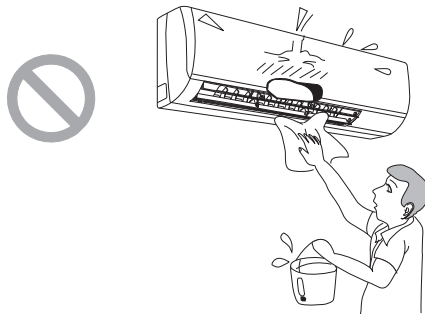

- ★ Don't place a space heater near the air conditioner.



Or CO toxicosis may occur for incomplete burning.

◆ Notices for use

Working principle and special functions for cooling

Principle:

Air conditioner absorbs heat in the room and transmit to outdoor and discharged, so that indoor ambient temperature decreased, its cooling capacity will increase or decrease by outdoor ambient temperature.

Anti-freezing function:

If the unit is running in COOL mode and in low temperature, there will be frost formed on the heat exchanger, when indoor heat exchanger temperature decreased below 0°C, the indoor unit microcomputer will stop compressor running and protect the unit.

Working principle and special functions for heating

Principle:

- * Air conditioner absorbs heat from outdoor and transmits to indoor, in this way to increase room temperature. This is the heat pump heating principle, its heating capacity will be reduced due to outdoor temperature decrease.
- * If outdoor temperature becomes very low, please operate with other heating equipments.

Defrosting:

- * When outdoor temperature is low but high humidity, after a long while running, frost will form on outdoor unit, that will effect the heating effect, at this time, the auto defrosting function will act, the heat running will stop for 8-10mins.
- * During the auto defrosting, the fan motors of indoor unit and outdoor unit will stop.
- * During the defrosting, the indoor indicator flashes, the outdoor unit may emit vapor. This is due to the defrosting, it isn't malfunction.
- * After defrosting finished, the heating will recover automatically.

Anti-cool wind function:

In "Heat" mode, under the following three kinds of state, if indoor heat exchanger doesn't arrive at certain temp., indoor fan will not act, in order to prevent cool wind blowing (within 3 mins):

1. Heating starts.
2. After Auto Defrost finished.
3. Heating under the low temperature.

Gentle Breeze

In the following situation, the indoor unit may blow gentle breeze, and the guide louver rotate to a certain position:

1. In "Heat" mode, the unit turned on, the compressor doesn't arrive the starting condition.
2. In "Heat" mode, the temperature arrive at the setting value and the compressor stop running about 1min.

◆ Names and functions of each part

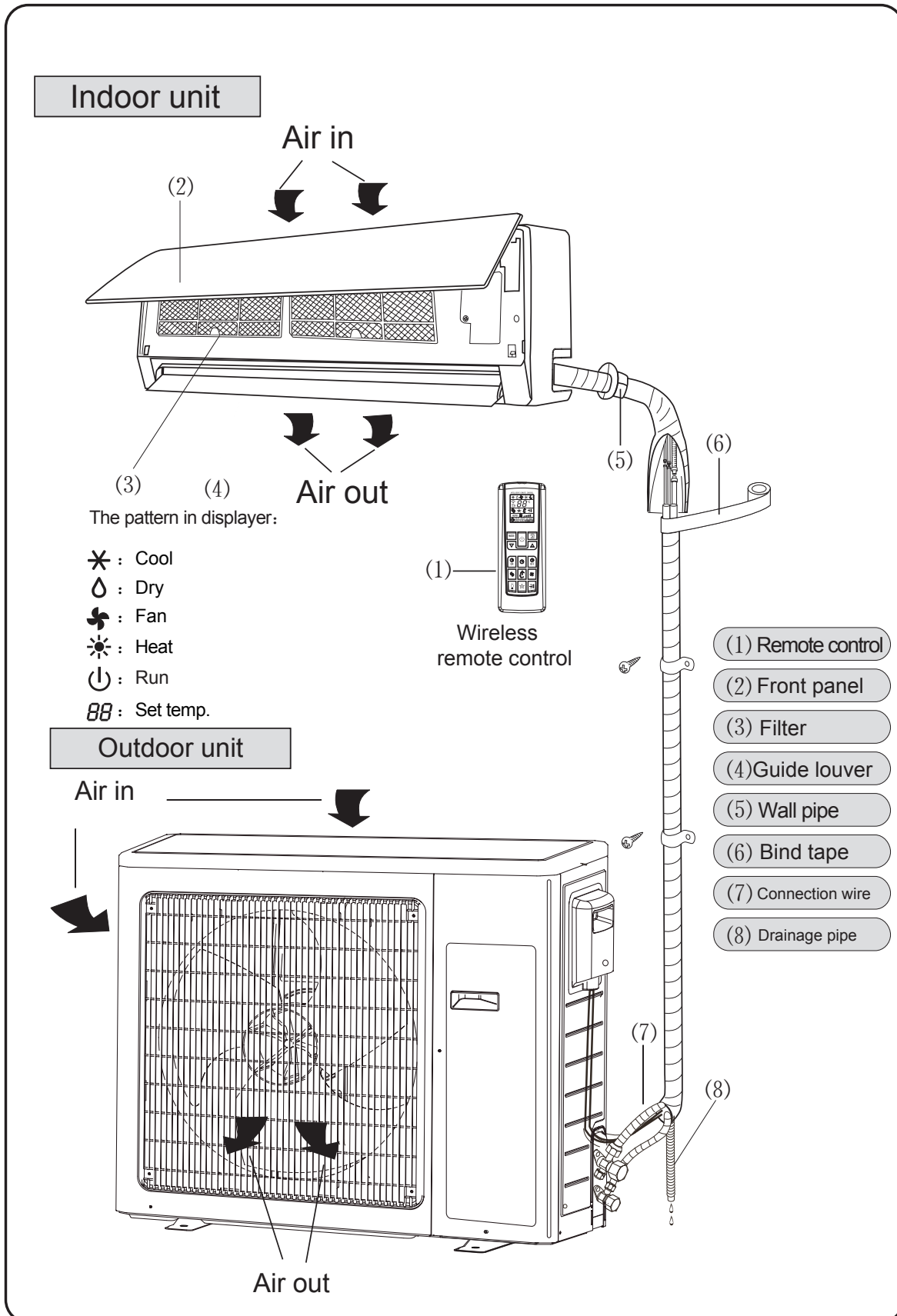

◆ Operation of wireless remote control

Names and functions of wireless remote control

Note: Be sure that there are no obstructions between receiver and remote controller; Don't drop or throw the remote control; Don't let any liquid in the remote control and put the remote control directly under the sunlight or any place where is very hot.

Signal transmitter

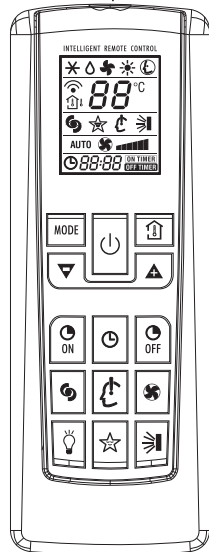

Remote control



ON/OFF button

- Press this button, the unit will be turned on, press it once more, the unit will be turned off. Sleep function will be canceled, while unit off.

MODE

MODE button

- Press this button, AUTO, Cool, Dry, Fan, Heat mode can be selected circularly. AUTO MODE is default while power on. Under AUTO MODE, the temperature will not be displayed; Under Heat mode, the initial value is 28°C (82°F); Under other modes, the initial value is 25°C (77°F).

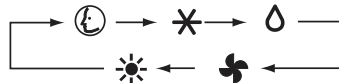

- Ⓛ AUTO
- ❄ COOL
- 💧 DRY
- 🌀 FAN
- ☀ HEAT

(only for cooling and heating unit)



SLEEP button

- Press this button, Sleep On and Sleep Off can be selected. After powered on, Sleep Off is defaulted. After the unit is turned off, the Sleep function is canceled. After Sleep function set up, the signal of Sleep will display. In this mode, the time of timer can be adjusted. Under Fan and 6th SENSE modes, this function is not available.



FAN button

- Press this button, Auto, Low, Middle, High speed can be circularly selected. After powered on, Auto fan speed is default.

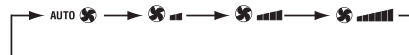

- AUTO Ⓛ Auto fan 🌀 Low fan
- 🌀 Middle fan 🌀 High fan



CLOCK button

- Press to set present time and then Ⓛ flashes. Press ▲ or ▼ to adjust the time numeral segment within 5 seconds, if you press this button for more than 2 seconds, the time will increase or decrease 10 mins per 0.5second; if you press Ⓛ again when the time flashing, the flash will stop and it denotes the setting succeeded. After powered on, 12:00 is defaulted to display it denotes the setting succeeded. After powered on, 12:00 is defaulted to display and Ⓛ signal will be displayed. If the Ⓛ displayed on the screen, that denotes the current time value is Clock value, otherwise is Timer value.



LIGHT button

- Press this button at unit On or Off status, Light On and Light Off can be set up. After powered on, Light On is defaulted.

◆ Operation of wireless remote control

Names and functions of wireless remote control

This wireless remote control is universal, and it could be used for many units, some buttons of this control which are not available to this unit will not be described below.

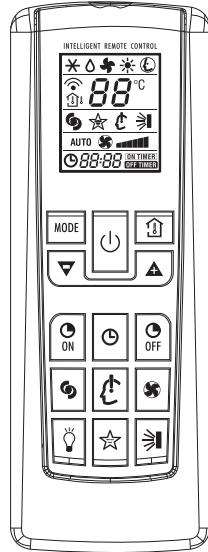

Remote control



TURBO button

- Under Cool or Heat mode, press this button can turn on or turn off the TURBO function. After the TURBO function turned on, the signal of TURBO will display. The signal will be automatically cancelled if changing the mode or fan speed.



TEMP button

- Press this button, can select: setting temperature (◀), indoor ambient temperature (▶), outdoor ambient temperature (◀▶). These temperature will show on the indoor unit display. The temperature on remote control is always setting temperature. Outdoor ambient temperature is an optional feature, which is unavailable for this model. The temperature display for ▶ will keep same as previous temperature.



I FEEL button

- Press this button once, to turn on the I FEEL function, then the figure of I FEEL icon will appear. After this function started, the remote control will send temperature to the main unit in every 10 minutes. When repress this button, this function will be turned off.
Note: I FEEL function refers to that the air conditioner works according to the ambient temperature of the remote controller.



+ button

- Presetting temperature can be increased. Press this button, the temperature can be set up, continuously press this button and hold for two seconds, the relative contents can quickly change, until unhold this button and send the order that the °C (°F) signal will be displayed all the time. The temperature adjustment is unavailable under the AUTO mode. Temperature of Celsius degree setting: 16-30 ; for Fahrenheit degree setting: 61-86.



- button

- Presetting temperature can be decreased. Press this button, the temperature can be set up, continuously press this button and hold for two seconds, the relative contents can quickly change, until unhold this button and send the order that the °C (°F) signal will be displayed all the time. The temperature adjustment is unavailable under the AUTO mode.

◆ Operation of wireless remote control

Names and functions of wireless remote control

This wireless remote control is universal, and it could be used for many units, some buttons of this control which are not available to this unit will not be described below.

Remote control

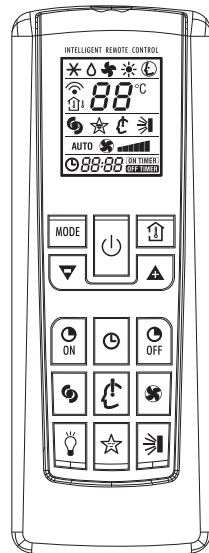

ON

TIMER ON BUTTON

- Timer On setting: "ON" flashes and will conceal, numeral segment become timer-on setting status. Pressing ▲ or ▼ could adjust the numeral segment of time, increase or decrease 1 minute per time within 5 seconds. If you hold pressing ▲ or ▼, the numeral will change quickly after 2 second. The way of the change is : in the first 2.5 seconds, the change step is 1 minute. After 2.5 seconds, the change step is 10 minutes. Press this button within 5 seconds flashing, the timer setting succeeds. Re-press this button, the timer-on will be canceled. Before setting the Timer please adjust the Clock to the current actual time.

OFF

TIMER OFF BUTTON

- One press this key to enter into TIMER OFF setup, in which case the TIMER OFF icon will blink. The method of setting is the same as for TIMER ON.



SWING UP AND DOWN BUTTON

- Press this button to set swing angle, which circularly changes as below:





If guide louver is stopped when it is swinging up and down, it will remain its present position.

☞ ☞ ☞ ☞ indicates guide louver swings back and forth in all the five places, as shown in the figure ☞.



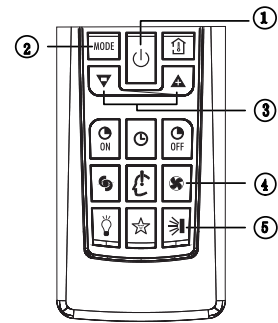

◆ Operation of wireless remote control

Guide for operation- General operation

1. After powered on, press ON/OFF button, the unit will start to run.(Note: When it is powered on, the guide louver of main unit will close automatically.)
2. Press MODE button, select desired running mode, or press COOL or HEAT mode to enter into the corresponding operation directly.
3. Pressing + or - button, to set the desired temperature.
4. Press  key to set the fan speed. AUTO, LOW, MEDIUM and HIGH are available at your selection.
5. Pressing  button, to select the swing.



Guide for operation- Optional operation

1. Press  to set the sleep mode.
2. Press  , + and - key to set your expected time for auto start or auto stop.
3. Press  key to turn on or off the air conditioner display.
4. Press  key. At one press of this key, the  icon will start to blink and enter into clock adjustment status.

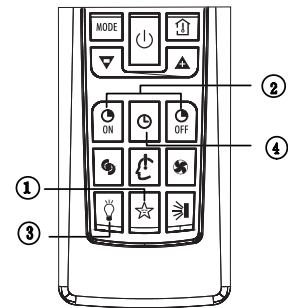

Introduction for special function

★ About AUTO function

When AUTO mode is selected, the setting temperature will not be displayed on the LCD, the unit automatically select the suitable running method and to make ambient comfortable according to the room temp.

★ About TURBO Function



If start this function, the unit will run at super-high fan speed to cool or heat quickly so that the ambient temp approaches the preset temp as soon as possible.

◆ Operation of wireless remote control

★ About lock

Press ▲ and ▼ buttons simultaneously to lock or unlock the keyboard. If the remote controller is locked, press any button, the remote control can't work, you must unlock the keyboard.

★ About swing

1. Press swing button continuously more than 2seconds, the main unit will swing back and forth from up to down, and then loosen the button, the unit will stop swinging and present position of guide louver will be kept immediately.
2. Under swing mode, when the status is switched from off to , if press this button again 2seconds later,  status will switch to off status directly; if press this button again within 2seconds, the change of swing status will also depend on the circulation sequence stated above.

★ About switch between Fahrenheit and Centigrade

Under status of unit off, press mode and ▼ buttons simultaneously to switch °C and °F.

Changing batteries and notices

1. Slightly to press the place with , along the arrowhead direction to push the back cover of wireless remote control. (As show in figure)
2. Take out the old batteries. (As show in figure)
3. Insert two new AAA1.5V dry batteries, and pay attention to the polarity. (As show in figure)
4. Attach the back cover of wireless remote control. (As show in figure)

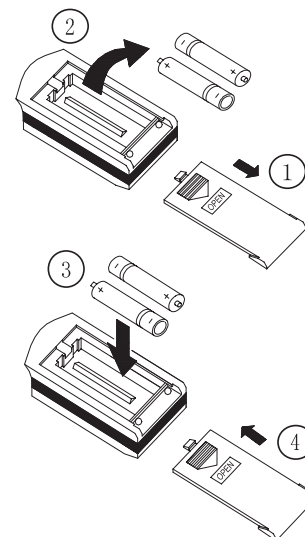

Sketch map for changing batteries



★ NOTE:

- When changing the batteries, do not use the old or different batteries, otherwise, it can cause the malfunction of the wireless remote control.
- If the wireless remote control will not be used for a long time, please take them out, and don't let the leakage liquid damage the wireless remote control.
- The operation should be in its receiving range.
- It should be placed at where is 1m away from the TV set or stereo sound sets.
- If the wireless remote control can not operate normally, please take them out, after 30s later and reinsert, if they cannot normally run, please change them.

◆ Emergency operation (only on some models)

Displayer indicator light control of indoor unit

It's a special selective button for the users, who are not accustomed to the light at sleeping.

- Get the displayer indicator light on: When setting the light function, the mark  will display on the remote controller screen by pressing this button. In which case, the displayer indicator light will be on if the AC receives this signal.
- Get the displayer indicator light off: If cancel the light function, the mark  will disappear on the remote controller screen by pressing this button. In which case, the displayer indicator light will be off if the AC receives this signal.

Emergency operation

If the wireless remote control is lost or broken, please use the manual switch button. At this time, the unit will run at the Auto mode, but the temperature and fan speed cannot be changed. The operation was shown as below:

To open the panel, the manual switch is on the displayer box.

- Turn on the unit: At unit turned off, press the button, the unit will run at Auto mode immediately. The microcomputer will accord to the indoor temperature to select (Cooling, Heating, Fan) and obtain the comfortable effect.
- Turn off the unit: At unit turned on, press the button, the unit will stop working.

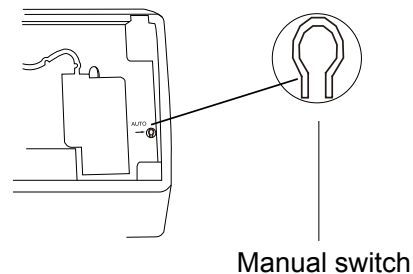

◆ Emergency Operation (only on some models)

Emergency Operation

When the wireless remote control is lost or damaged, please use the manual switch, at this time, it is running in Auto Run mode that will not change the temperature setting value and fan speed.

The manual switch can be operated as follow:

- At operation: When the unit stopped running, press ON/OFF button, unit will enter into AUTO RUN mode. The microcomputer will accord to the room temperature to select the (COOL, HEAT, FAN) mode automatically, to obtain the comfortable effect.
- At stopping: When the unit is running, press the ON/OFF button of the manual switch, the unit will stop work.

The code switch can be operated as follow:

- At operation: When the unit is stopped running, adjust the code switch to AUTO, the unit will enter into AUTO RUN mode. The microcomputer will accord to the room temperature to select the (COOL, HEAT, FAN) mode automatically, to obtain the comfortable effect.
- At stopping: When the unit is running, adjusts the code switch to STOP position, the unit will stop work.

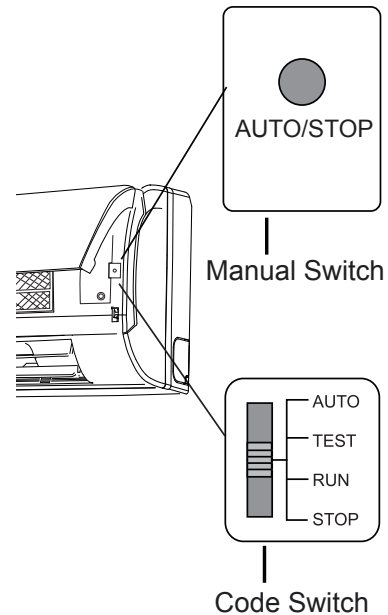

◆ Clean and care



Caution

- Turn power off and pull out the power plug before cleaning air conditioner, or it may cause electric shock.
- Never sprinkle water on the indoor unit and the outdoor unit for cleaning because it can cause an electric shock.
- Volatile liquid (e.g. thinner or gasoline) will damage the air conditioner. (So wipe the units with a dry soft cloth, or a cloth slightly moistened with water or cleanser.)

Clean the front panel

When cleaning the front panel, please dip the cloth into the water temperature of 45°C below, then to dry the cloth and wipe the dirty part.

Note: Please do not to immerse the front panel in water, due to there are microcomputer components and circuit diagrams on the front panel.

Clean the air filter (Recommended once every three months)

NOTE: If dust is much more around the air conditioner, the air filters should be cleaned many times. After taking off the filter, don't touch the fin of indoor unit, in order to avoid hurt your fingers.

① Take down the air filter

At the slot of surface panel to open an angle, pull the air filter downward and take it out, please see the figures a and b.

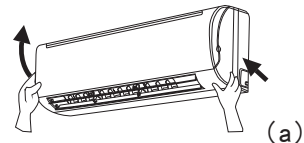

② Clean the air filter

To clean the dust adhering to the filters, you can either use a vacuum cleaner, or wash them with warm water the water with the neutral detergent should below 45 degree), and dry it in the shade.

NOTE: Never use water above 45°C to clean, or it can cause deformation or discoloration. Never parch it by fire, or can cause a fire or deformation.

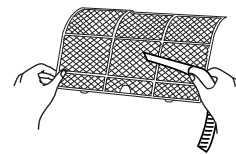
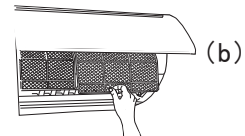

③ Insert the air filter

Reinsert the filters along the direction of arrowhead, and then to cover the cover and clasp it.

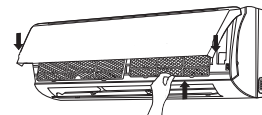

◆ Clean and care

Check before use

- ① Be sure that nothing obstructs the air outlet and intake vents.
- ② Check that whether ground wire is properly connected or not.
- ③ Check that whether the batteries of air conditioner are changed or not.
- ④ Check that whether the installation stand of the outdoor unit is damaged or not. If damaged, please contact the dealer.

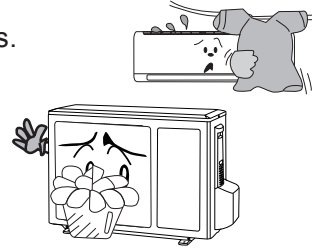

Maintain after use

- ① Turn main power off.
- ② Clean the filter and indoor and outdoor units' bodies.
- ③ Clear dust and obstructions from the outdoor unit.
- ④ Repaint the rubiginous place on the outdoor unit to prevent it from spreading.
- ⑤ Adopt the special shield to cover the outdoor unit, avoid the rain water, dust enter into the unit and get rust.

◆ Troubleshooting



CAUTION

Don't attempt to repair the air conditioner by yourself, it can cause an electric shock or fire. Please check the following items before asking for repair, it can save your time and money.

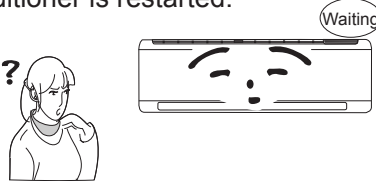
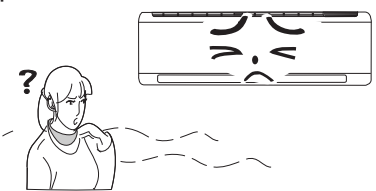
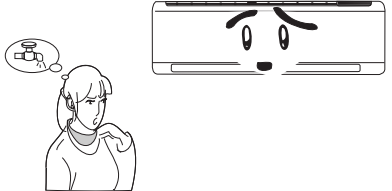
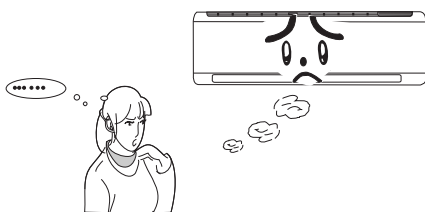
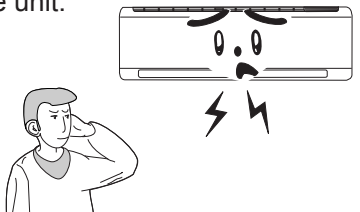
Phenomenon	Troubleshooting
<p>Not operate immediately when the air conditioner is restarted.</p> 	<ul style="list-style-type: none"> Once the air conditioner is stopped, it will not operate in approximately 3 minutes to protect itself.
<p>There's unusual smell blowing from the outlet after operation is started.</p> 	<ul style="list-style-type: none"> The unit has no peculiar smell by itself. If has, that is due to the smell accumulated in the ambient. Solution method: Cleaning the filter. If problem still has, so need to clean air conditioner. (Please contact with the authorized maintenance center.)
<p>Sound of water flow can be heard during the operation.</p> 	<ul style="list-style-type: none"> The air conditioner is started, when it is running the compressor started or stopped running, or the unit is stopped, sometimes there is swoosh or gurgle, the sound is due to refrigerant flowing they are not malfunctions.
<p>In COOL mode, sometimes the mist emitted from the air outlet vent.</p> 	<ul style="list-style-type: none"> When the indoor temperature and humidity are very high, this phenomenon would happen. This is caused by the room air is swiftly cooled down. After running for a while, indoor temperature and humidity will fall down, the mist will die away.
<p>Creaking noise can be heard when start or stop the unit.</p> 	<ul style="list-style-type: none"> This is caused by the deformation of plastic due to the changes of temperature.

◆ Troubleshooting

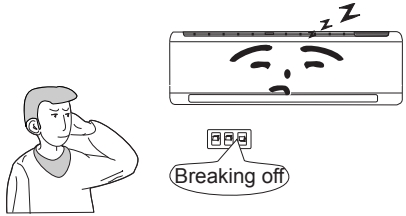
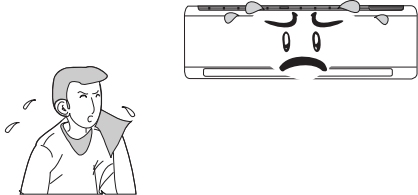
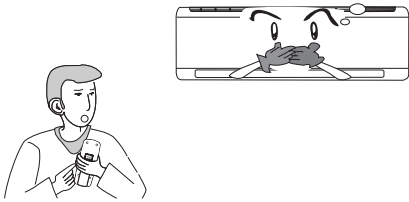
Phenomenon	Troubleshooting
<p>The unit can not run.</p> 	<ul style="list-style-type: none"> ● Has the power been shut down? ● Is power plug loosed? ● Is the circuit protection device tripped off or not? ● Is voltage higher or lower? (Tested by professionals) ● Is the TIMER correctly used?
<p>Cooling(Heating) efficiency is not good.</p> 	<ul style="list-style-type: none"> ● Is Temp. setting suitable? ● Were inlet and outlet vents obstructed? ● Is filter dirty? ● Are the windows and doors closed? ● Did Fan speed set at low speed? ● Is there any heat sources in the room?
<p>Wireless remote control is not available.</p> 	<ul style="list-style-type: none"> ● The unit is interfered by abnormal or frequent functions switchover occasionally the controller cannot operate. At this time, you need to pull out of the plug, and reinsert it. ● Is it in its receiving range? Or obstructed? To check the voltage in wireless remote control inside is charged, otherwise to replace the batteries. ● Whether the wireless remote control is damaged.
<p>If water leakage in the room.</p>	<ul style="list-style-type: none"> ● The air humidity is on the high side. ● Condensing water over flowed. ● The connection position of indoor unit drainage pipe is loosed.
<p>If water leakage in outdoor unit.</p>	<ul style="list-style-type: none"> ● When the unit is running in COOL mode, the pipe and connection of pipe would be condensed due to the water cooled down. ● When the unit is running in Auto Defrosting mode the ice thawed and flowed out. ● When the unit is running in HEAT mode, the water adhered on heat exchanger dripped off.
<p>Noise from indoor unit emitted.</p>	<ul style="list-style-type: none"> ● The sound of fan or compressor relay is switching on or off. ● When the defrosting is started or stop running, it will sound. That is due to the refrigerant flowed to the reverse direction.

◆ Troubleshooting

Phenomenon	Troubleshooting
Indoor unit cannot deliver air.	<ul style="list-style-type: none"> ● In HEAT mode, when the temperature of indoor heat exchanger is very low, that will stop deliver air in order to prevent cool air. (Within 2min) ● In HEAT mode, when the outdoor temperature is low or high humidity, there are much frost be formed on the outdoor heat exchanger, that the unit will automatically defrost, indoor unit stop blowing air for 3-12min. During the defrosting, there is water flowing out or vapor be produced. ● In dehumidifying mode, sometimes indoor fan will stop, in order to avoid condensing water be vaporized again, restrain temperature rising.
Moisture on air outlet vent.	<ul style="list-style-type: none"> ● If unit is running under the high humidity for a long time, the moisture will be condensed on the air outlet grill and drip off.



Immediately stop all operations and plug out, contact the dealer in following situations.

There is harsh sound during operation.
 The terrible odors emitted during operation.
 Water is leaking in the room.
 Air switch or protection switch often breaks.
 Careless splash water or something into unit.
 There is an abnormal heat in power supply cord and power plug.

▶ Stop running and pull out of the plug.

◆ Notices for installation



Important Notices

1. The unit installation work must be done by qualified personnel according to the local rules and this manual.
2. Before installing, please contact with local authorized maintenance center, if unit is not installed by the authorized maintenance center, the malfunction may not solved, due to discommodious contacts.
3. When removing the unit to the other place, please firstly contact with the authorized Maintenance Center in the local area.
4. the appliance must be positioned so that the plug is accessible
5. After pull out the power plug then make the appliance operation again, to avoid the icing of outdoor unit damage axial flow fan, should electrify the appliance but not operation for 4 hours for warm-up purpose (only on some models).



This appliance has been made for air-conditioning domestic environments and must not be used for any other purpose, such as for drying clothes, cooling food, etc.

Basic Requirements For Installation Position

Install in the following place may cause malfunction. If it is unavoidable contact with service center please:

- Place where strong heat sources, vapors, flammable gas or volatile object are emitted.
- Place where high-frequency waves are generated by radio equipment, welders and medical equipment.
- Place where a lot of salinities such as coast exists.
- Place where the oil (machine oil) is contained in the air.
- Place where a sulfured gas such as the hot spring zones is generated.
- Other place with special circumstance.

Indoor Unit Installation Position Selection

1. The air inlet and outlet vent should be far from the obstruction, make sure that the air can be blown through the whole room.
2. Select a position where the condensing water can be easily drained out, and the place is easily connected for outdoor unit.
3. Select a location where the children can not reach.
4. Can select the place where is strong enough to withstand the full weight and vibration of the unit. And will not increase the noise.
5. Be sure to leave enough space to allow access for routine maintenance. The height of the installed location should be 250cm or more from the floor.
6. Select a place about 1m or more away from TVset or any other electric appliances.
7. Select a place where the filter can be easily taken out.
8. Make sure that the indoor unit installation should accord with installation dimension diagram requirements.
9. Do not use the unit in the immediate surroundings of a laundry a bath a shower or a swimming pool.

◆ Notices for installation

Outdoor Unit Installation Position Selection

1. Select a location from which noise and outflow air emitted by unit will not inconvenience neighbors, animals, plants.
2. Select a location where there should be sufficient ventilation.
3. Select a location where there should be no obstructions cover the inlet and outlet vent.
4. The location should be able to withstand the full weight and vibration of the outdoor unit and permit safe installation.
5. Select a dry place, but do not expose under the direct sunlight or strong wind.
6. Make sure that the outdoor unit installation dimension should accord with installation dimension diagram, convenient for maintenance, repair.
7. The height difference of connecting the tubing within 5m, the length of connecting the tubing within 10m.
8. Select a place where it is out of reach for the children.
9. Select a place where will not block the passage and do not influence the city appearance.

Safety Requirements For Electric Appliances

1. The power supply should be used the rated voltage and AC exclusive circuit, the power cable diameter should be satisfied.
2. Don't drag the power cable emphatically.
3. It should be reliably earthed, and it should be connected to the special earth device, the installation work should be operated by the professional.
The air switch must have the functions of magnetic tripping and heat tripping, in order to protect the short circuit and overloading.
4. The min. distance from the unit and combustive surface is 1.5m.
5. The appliance shall be installed in accordance with national wiring regulations.
6. An all-pole disconnection switch having a contact separation of at least 3mm in all poles should be connected in fixed wiring.

Note:

- Make sure that the Live wire or Zero line as well as the earth wire in the family power socket can not be wrong connected, there should be reliable and no short circuit in the diagram.
- wrong connection may cause fire.

Earthing requirements

1. Air conditioner is type I electric appliance, thus please do conduct reliable earthing measure.
2. The yellow-green two-color wire in air conditioner is earthing wire and cannot be used for other propose. It cannot be cut off and be fix it by screw, otherwise it would cause electric shock.
3. The earth resistance should accord to the National Criterion.
4. The user power must offer the reliable earthing terminal. Please don't connect the earthing wire with the following place:
 - ① Tap water pipe.
 - ② Gas pipe.
 - ③ Contamination pipe.
 - ④ Other places that professional personnel consider them unreliable.
5. The model and rating values for fuses according the silk print on fuse cover or related PCB board.

◆ Installation dimension diagram

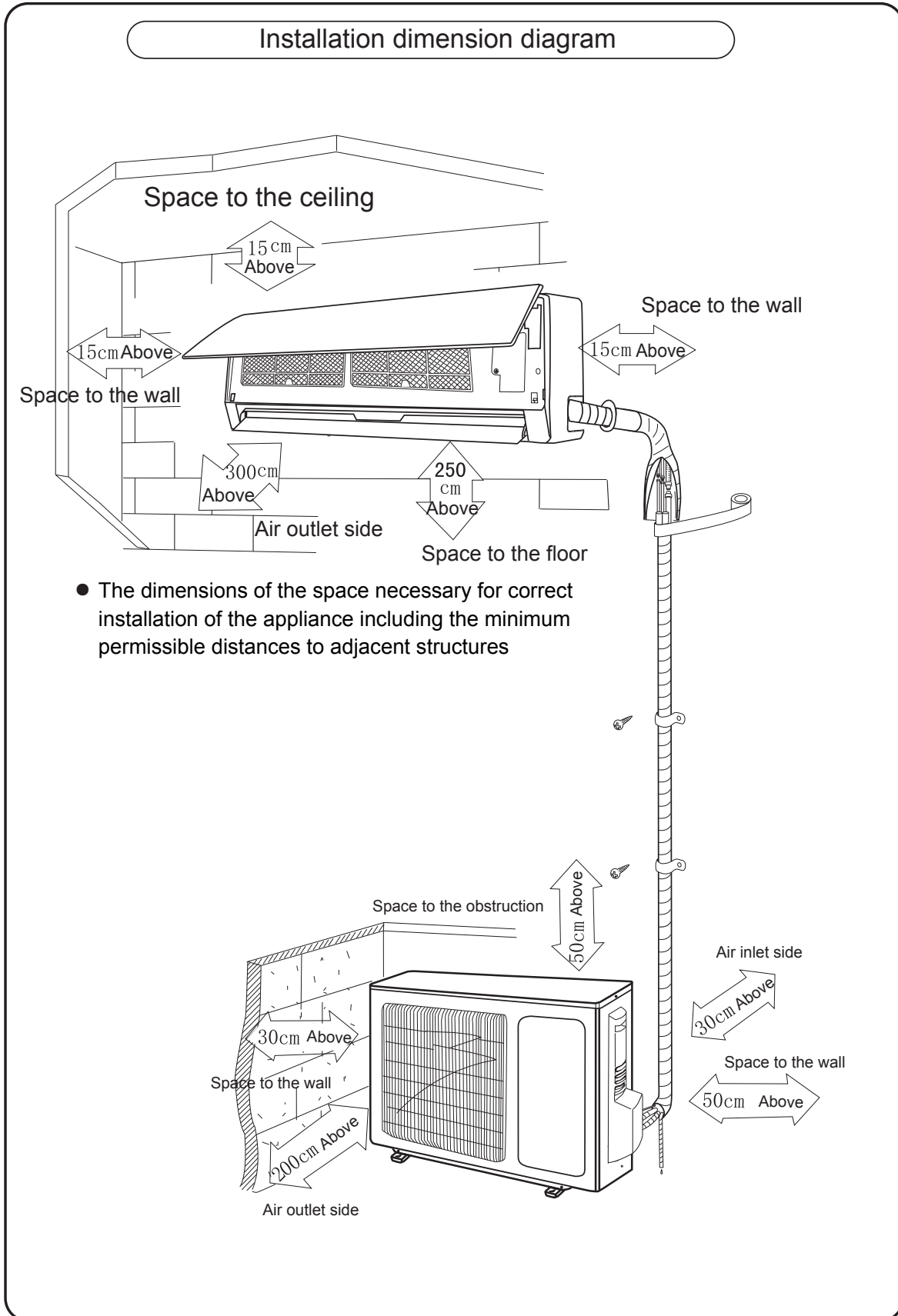

◆ Install indoor unit

Install the rear panel

1. Always mount the rear panel horizontally. Due to the water tray of indoor unit has been adopted the both-way drainage design, the outlet of water tray should be adjusted slightly down when installing, that is taking the outlet of the water tray as the center of a circle, the included angle between the evaporator and level should be 0 or more, that is good for condensing water drainage.
2. Fix the rear panel on the wall with screws. (Where is pre-covered with plastic granula)
3. Be sure that the rear panel has been fixed firmly enough to withstand the weight of an adult of 60kg, further more, the weight should be evenly shared by each screw.

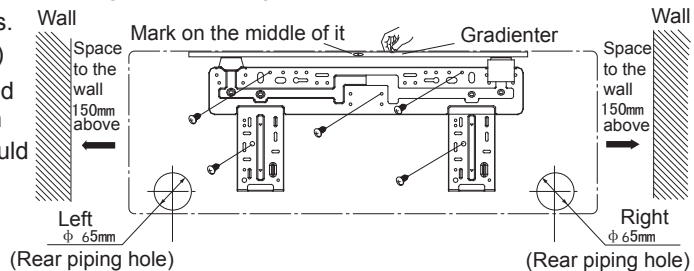

Install the piping hole

1. Make the piping hole ($\Phi 55$) in the wall at a slight downward slant to the outdoor side.
2. Insert the piping-hole sleeve into the hole to prevent the connection piping and wiring from being damaged when passing through the hole.

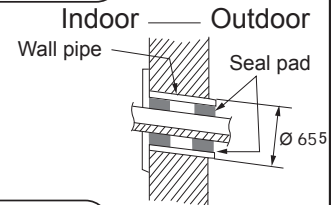

Install the water drainage pipe

1. For well draining, the drain hose should be placed at a downward slant.
2. Do not wrench or bend the drain hose or flood its end by water.
3. When the long drainage hose passing through indoor, should wrap the insulation materials.

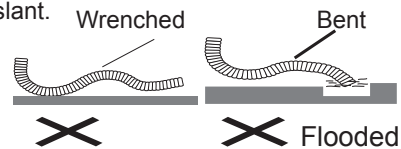

Connect indoor and outdoor electric wires

1. Open the surface panel.
2. Remove the wiring cover (see figure below).
3. Route the power connection cord and signal control wire (for cooling and heating unit only) from the back of the indoor unit and pull it toward the front through the wiring hole for connection.
4. Connect the interconnection cord to the terminal block, and then fix the cord with cord anchorage.
5. Reassemble the clamp and wiring cover.
6. Recover the surface panel.

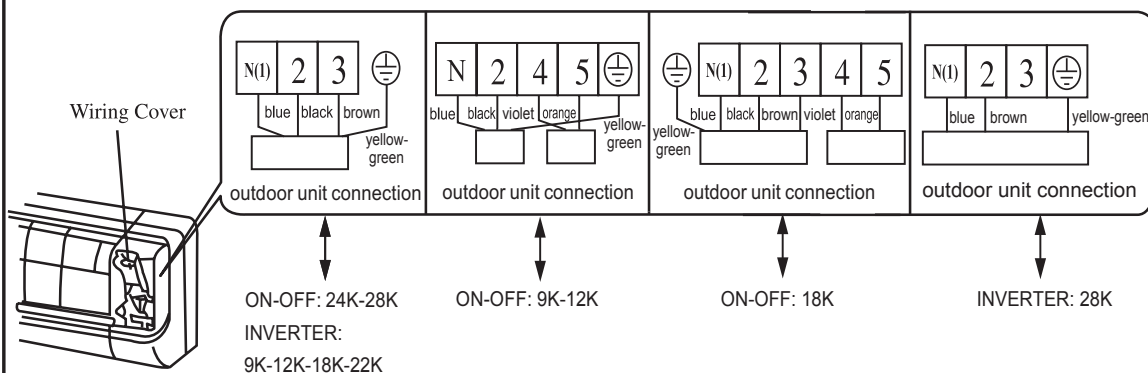

◆ Install indoor unit

NOTE:

When connecting the electric wire if the wire length is not enough, please contact with the authorized service shop to buy a exclusive electric wire that is long enough and the joint on the wire are not allowed.

- The electric wiring must be correctly connected, wrong connection may cause spare parts malfunction.
- Tighten the terminal screw in order to prevent loose.
- After tighten the screw, slight pull the wire and confirm whether is it firm or not.
- If the earth wire is wrong connection, that may cause electric shock.
- The cover plate must be fixed, and tighten the connection wire, if it is poor installed, that the dust, moisture may enter in or the connection terminal will be affected by outside force, and will cause fire or electric shock.

Install the indoor unit

- The piping can be lead out from right, right rear, left left rear.
1. When routing the piping and wiring from the left or right side of indoor unit, cut off the tailings from the chassis in necessary(Show in Fig.1)
 - (1) Cut off the tailings 1 when routing the wiring only;
 - (2) Cut off the tailings 1 and tailings 2 when routing both the wiring and piping.
 2. Take out the piping from body case, wrap the piping electric wire, water pipe with tape and pull them through the piping hole (As show in Fig.2)
 3. Hange the mounting slots of the indoor unit on the upper tabs of the rear panel and check if it is firm enough.(As show in Fig.3)
 4. The height of the installed location should be 2.5m or more from the floor.

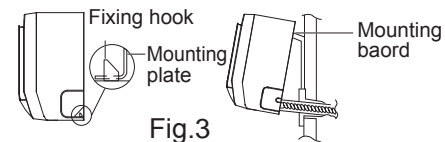
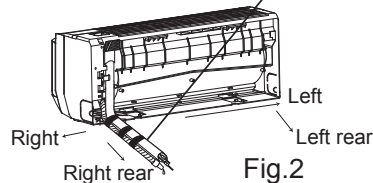
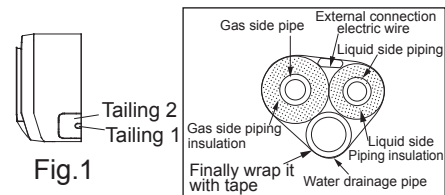

Install the connection pipe

1. Align the center of the piping flare with the relevant valve.
2. Screw in the flare nut by hand and then tighten the nut with spanner and torque wrench refer to the following:

Hex nut diameter	Tightening torque (N • m)
Φ6	15~20
Φ 9. 52	31~35
Φ 12	50~55
Φ 16	60~65
Φ 19	70~75

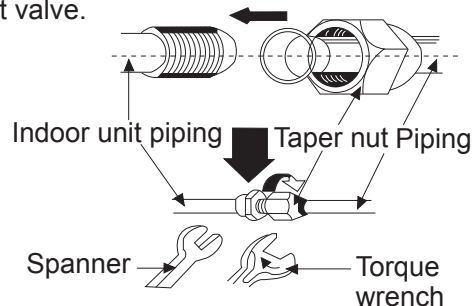

NOTE: Firstly connect the connection pipe to indoor unit, then to outdoor unit; pay attention to the piping bending, do not damage the connection pipe; the joint nut couldn't tighten too much, otherwise it may cause leakage.

◆ Install outdoor unit

Electric wiring

1. Disassemble the handle on the outdoor unit right side plate.
2. Take off cord anchorage. Connect and fix power connect cord (for cooling and heating unit, connect and fix power connect cord and signal control wire) to terminal block.
3. Fix the power connection cable with cord anchorage, (for cooling and heating unit, use the cord anchorage to fix the power connection cable and the signal control wire).
4. Ensure wire has been fixed well.
5. Install the handle.

NOTE:

- Wrong wiring may cause spare parts malfunction.
- After the cable fixed, make sure there should be a free space between the connection and connection and fixing place on the lead wire.

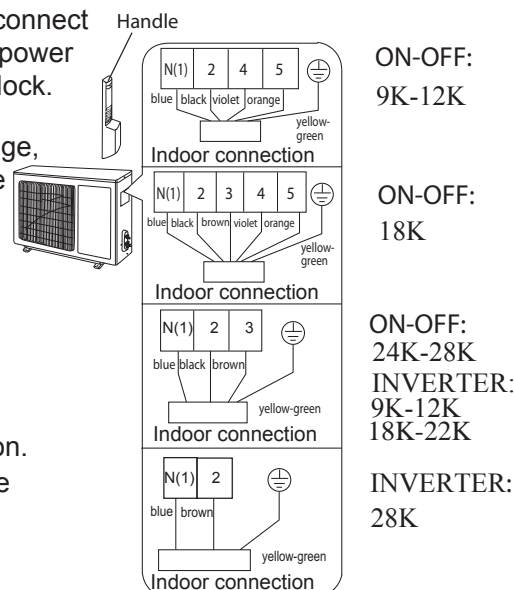

Air purging and leakage test

1. Connect charging hose of manifold valve to charge end of low pressure valve (both high/low pressure valves must be tightly shut).
2. Connect joint of charging hose to vacuum pump.
3. Fully open handle handle of Lo manifold valve.
4. Open the vacuum pump to evacuate. At the beginning, slightly loosen joint nut of low pressure valve to check if there is air coming inside. (If noise of vacuum pump has been changed, the reading of multimeter is 0) Then tighten the nut.
5. Keep evacuating for more than 15mins and make sure the reading of multi-meter is $-1.0 \times 10^5 \text{pa}$ (-76cmHg).
6. Fully open high/low pressure valves.
7. Remove charging hose from charging end of low pressure valve.
8. Tighten bonnet of low-pressure valve. (As shown in Fig. 4)

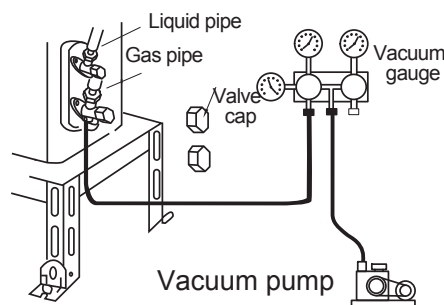
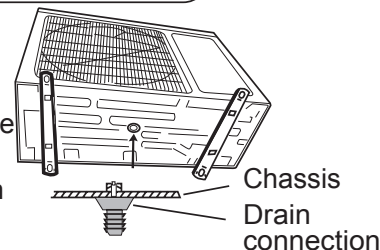

Fig. 4

Condensate drainage of outdoor unit (no for cooling only)

The condensate and defrosting water formed during heating in the outdoor unit can be properly discharged by drainage pipe.

Installation method: set the drain connection in $\varnothing 25$ hole of the chassis has been installed and then connect drainage pipe with drain nozzle, so that condensate and defrosting water can be properly discharged.



◆ Check after installation and test operation

Check after installation

Items to be checked	Possible malfunction
Has it been fixed firmly?	The unit may drop, shake or emit noise.
Have you done the refrigerant leakage test?	It may cause insufficient cooling(heating) capacity
Is heat insulation sufficient?	It may cause condensation and dripping.
Is water drainage well?	It may cause condensation and dripping.
Is the voltage in accordance with the rated voltage marked on the nameplate?	It may cause electric malfunction or damage the part.
Is the electric wiring and piping connection installed correctly and securely?	It may cause electric malfunction or damage the part.
Has the unit been connected to a secure earth connection?	It may cause electrical leakage.
Is the power cord specified?	It may cause electric malfunction or damage the part.
Is the inlet and outlet been covered?	It may cause insufficient cooling(heating) capacity.
Has the length of connection pipes and refrigerant capacity been recorded?	The refrigerant capacity is not accurate.

Test Operation

1. Before test operation

- (1) Do not switch on power before installation is finished completely.
- (2) Electric wiring must be connected correctly and securely.
- (3) Cut-off valves of the connection pipes should be opened.
- (4) All the impurities such as scraps and thrums must be cleared from the unit.

2. Test operation method

- (1) Switch on power, press "ON/OFF" button on the wireless remote control to start the operation.
- (2) Press MODE button, to select the COOL, HEAT (Cooling only unit is not available), FAN to check whether the operation is normal or not.

◆ Installation and Maintenance of Healthy Filter

Installation Instructions

1. Forcibly pull the panel for a specific angle from the two ends of the front panel according to the arrow direction. Then pull the air filter downwards to remove it. (See Fig.a)

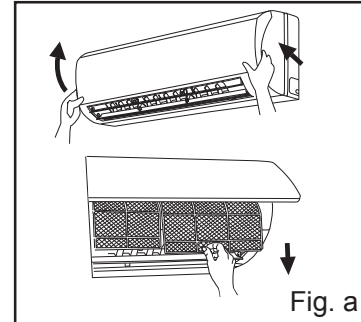

2. Mount the healthy filter onto the air filter, (as shown in Fig.b). If the air filter cannot be installed, please mount the healthy filter on the front case. (as shown in Fig.c)

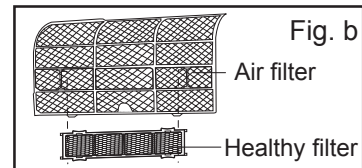

3. Mount the air filter properly along the arrow direction in Fig.d, and then close the panel cover.

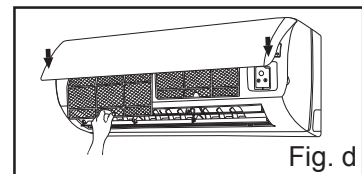
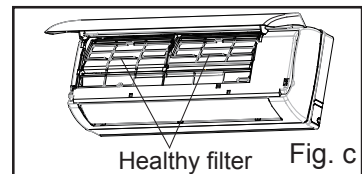

Cleaning and Maintenance

Take out the healthy filter before cleaning and reinstall it after cleaning according to the installation instruction. Pay special attention to that silver ion filter can't be cleaned with water, while active carbon, photocatalyst, low temperature conversion (LTC) catalyst, formaldehyde eliminator, catechin or mite killing filter can, but can't with brush or hard things. Dry it in the shade or sun after cleaning, but not by wiping.

Service Life

The healthy filter commonly has its usage lifetime for one year under normal condition. As for silver ion filter, it is invalid when its surface becomes black (green).

● This supplementary instruction is provided for reference to the unit with healthy filter. If the graphics provided herein is different from the physical goods, the latter one shall prevail. The quantity of healthy filters shall be based on the actual delivery.

TECHNICAL DATA On - Off **GENERAL INFORMATION**

MODELS (****)	9K	12K	18K	24K	28K		
General data							
Electricity supply	230-50 (*)					V~Hz	
Refrigerant gas	R410 A (**)						
Fuse	10	10	16	20	20	A	
Minimum cable section	1,0	1,0	1,5	2,5	2,5	mm	
Size and clearance							
	L	845	845	940	1178	1178	mm
	H	275	275	298	326	326	mm
	P	180	180	200	253	253	mm
	A	150					mm
	B	150					mm
	C	2500					mm
	D	150					mm
E	300					mm	
	L	848	848	913	980	980	mm
	P	320	320	378	427	427	mm
	H	540	592	680	790	790	mm
	C	300					mm
	D	500					mm
	F	300					mm
	E	2000					mm
Indoor unit net weight	10	10	13	17.5	17.5	kg	
Outdoor unit net weight	40	41	46	72	68	kg	
Connecting pipes							
Refrigerant pipe size	Liquid	6,0 - 1/4	6,0 - 1/4	6,0 - 1/4	6,0 - 1/4	6,0 - 1/4	inch
	Gas	9.52-3/8	12-1/2	12-1/2	16-5/8	16-5/8	inch
Pipe tightening torque	Liquid	20	20	20	20	20	Nm
	Gas	35	55	55	65	65	Nm
Quantity of refrigerant per metre of pipe (over 5 m)		20	20	20	50	50	g/m
	A (max)	10	10	10	10	10	m
	B (max)	15	20	25	30	30	m
	C (max)	10	10	10	10	10	m
Refrigerant charge	(***)						g.
Operating limits							
	Internal part bulb			External part bulb			
Cooling (Max ; Min)	32 ; 21			43 ; 21			°C
Heating (Max ; Min)	27 ; 20			24 ; -5			°C

(*) See the rating plate for the electricity supply.

(**) The appliance may be supplied with refrigerant gas R22 in countries where the use of refrigerant gas R410a is not compulsory.

(***) See the rating plate for the refrigerant charge.

(****) The models correspond respectively to the following De Longhi product names:
DECON28, DECON35, DECON52, DECON73, DECON81

MODELS (****)	9K	12K	18K	22K	28K			
General data								
Electricity supply	230-50 (*)					V-Hz		
Refrigerant gas	R410A(**)							
Fuse	10	10	20	20	20	A		
Minimum cable section	1,0	1,0	2,5	2,5	2,5	mm		
Size and clearance								
	L	790	845	940	1008	1178	mm	
	H	265	275	298	315	326	mm	
	P	170	180	200	219	253	mm	
	A	150					mm	
	B	150					mm	
	C	2500					mm	
	D	150					mm	
	E	300					mm	
		L	776	848	955	955	980	mm
		P	320	320	424	424	427	mm
H		540	540	700	700	790	mm	
C		300					mm	
D		500					mm	
F		300					mm	
E		2000					mm	
Indoor unit net weight		10	11	13	16	17.5	kg	
Outdoor unit net weight	32	36	47	50	67	kg		
Connecting pipes								
Refrigerant pipe size	Liquid	6,0 - 1/4	6,0 - 1/4	6,0 - 1/4	6,0 - 1/4	6,0 - 1/4	inch	
	Gas	9,52 - 3/8	9,52 - 3/8	12 - 1/2	12 - 1/2	16 - 5/8	inch	
Pipe tightening torque	Liquid	20	20	20	20	20	Nm	
	Gas	35	35	55	55	55	Nm	
Quantity of refrigerant per metre of pipe(over 5 m)		20	20	50	50	50	g/m	
	A (max)	10	10	10	10	10	m	
	B (max)	20	20	30	30	30	m	
	C (max)	10	10	10	10	10	m	
Refrigerant charge	(***)						g.	
Operating limits								
	Internal part bulb			External part bulb				
Cooling (Max : Min)	32 : 21			43 : 21		°C		
Heating (Max : Min)	27 : 20			24 : -5		°C		

(*) See the rating plate for the electricity supply.

(**) The appliance may be supplied with refrigerant gas R22 in countries where the use of refrigerant gas R410A is not compulsory.

(***) See the rating plate for the refrigerant charge.

(****) The models correspond respectively to the following De Longhi product names:
DEINV27, DEINV35, DEINV52, DEINV63, DEINV82

DE'LONGHI Appliances - Via Seitz, 47 - 31100 Treviso - Italia

5717310161/06.10/01

66129905672