

Split Air Conditioner

OWNER'S MANUAL

AIR CONDITIONERS

Thank you for choosing DE'LONGHI air conditioner for correct operation, please read this owner's manual carefully before operating the unit and keep it carefully for consultation.

◆ CONTENTS

Operation and maintenance

■ Notices for operation	1
■ Notices for use	3
■ Names and functions of each part	4
■ Operation of wireless remote control	5
■ Emergency operation	10
■ Clean and care	11
■ Troubleshooting.	13

Installation service

■ Notices for installation	16
■ Installation dimension diagram	18
■ Install indoor unit	19
■ Install outdoor unit	21
■ Check after installation and test operation	23
■ Installation and Maintenance of Healthy Filter	24

The figures in this manual may be different with the material objects, please refer to the material objects for reference.

 This symbol stands for the items should be forbidden  This symbol stands for the items should be followed



Do not dispose this product as unsorted municipal waste. Collection of such waste separately for special treatment is necessary.

◆ Notices for operation

Please read the following carefully before operating

! ★ When the voltage is very high, the components would be easily damaged, when the voltage is very low, the compressor vibrates terribly and that the refrigerant system will be damaged, the compressor and electric components cannot work, the voltage should be stable; there shouldn't be big fluctuation.

⊘ ★ Be sure to pull out the power plug as the air conditioner not in use for a long time. Otherwise, the accumulated dusts that may cause overheating or fire.

⊘ ★ Never splice the power cord or use an extended cord.

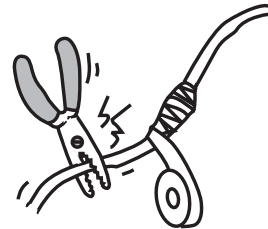
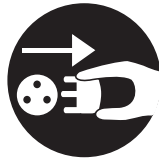

It can cause overheating or fire.

★ Don't leave windows and doors open for a long time while operating the air conditioner. It can decrease the air conditioning capacity.

⊘ ★ Don't block the air intake or outlet vents of both the outdoor and indoor units. It can decrease the air conditioning capacity or cause a malfunction.

★ The power supply must adopt the special circuit that with air switch protection and assure it has enough capacity. The unit will be turned on or off according to your requirement automatically, please do not turn on or turn off the unit frequently, otherwise disadvantage effect may be caused to the unit.

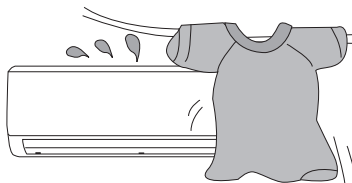
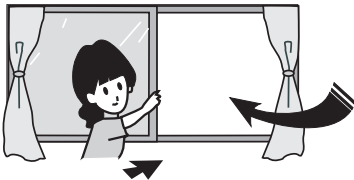

★ When having a burning smell or smoke, please turn off the power supply and contact with the service center.

⊘ ★ Keep combustible spray away from the units more than 1m.

⊘ ★ Don't attempt to repair the air conditioner by yourself.



If the abnormality still exists, the unit may be damaged, and may cause electric shock or fire.

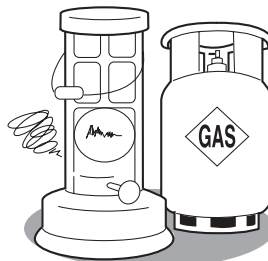

It can cause a fire or explosion

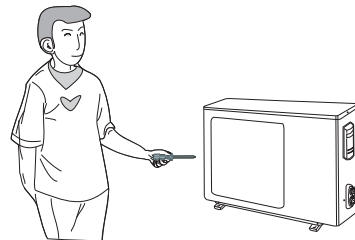

The wrong repair will lead to an electric shock or fire, so you should contact the service center to repair.

◆ Notices for operation



★ Please don't cut off or damage the power cords and control cords.

If they are damaged, please ask the qualified personnel to change them.

★ To adjust the airflow direction appropriately. When operating the unit, to adjust the vertical and lateral air flow direction by use of remote controller.

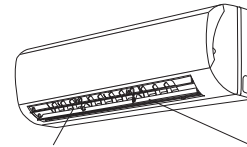

Swing louver Guide louver



★ Don't insert your hands or stick into the air intake or outlet vents.

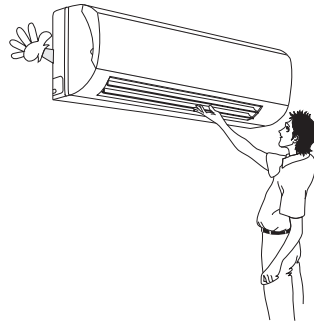

★ Don't blow the wind to animals and plants directly. It can cause a bad influence to them.

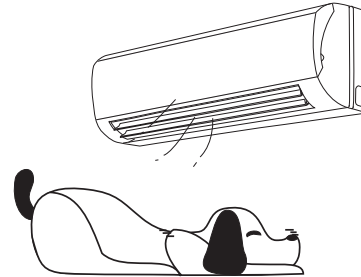

★ Don't apply the cold wind to the body for a long time.

It can cause the health problems.

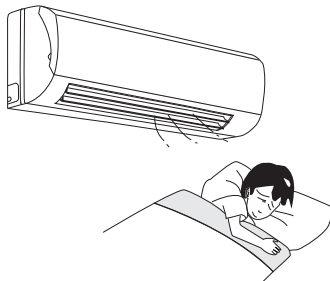

★ Don't use the air conditioner for other purposes, such as drying clothes, preserving foods, etc.

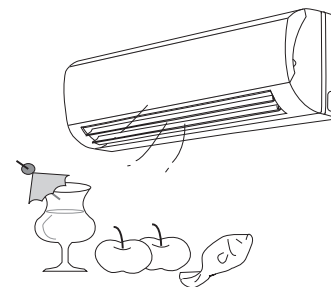

★ Splashing water on the air conditioner can cause an electric shock and malfunction.

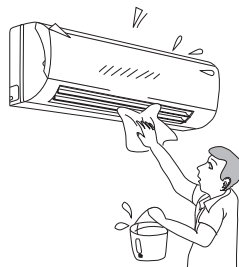

★ Don't place a space heater near the air conditioner.

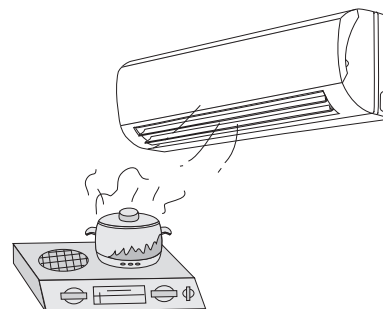

◆ Notices for use

Working principle and special functions for cooling

Principle:

Air conditioner absorbs heat in the room and transmit to outdoor and discharged, so that indoor ambient temperature decreased, its cooling capacity will increase or decrease by outdoor ambient temperature.

Anti-freezing function

If the unit is running in COOL mode and in low temperature, there will be frost formed on the heat exchanger, when indoor heat exchanger temperature decreased below 0°C, the indoor unit microcomputer will stop compressor running and protect the unit.

Working principle and special functions for heating

Principle:

- * Air conditioner absorbs heat from outdoor and transmits to indoor, in this way to increase room temperature. This is the heat pump heating principle, its heating capacity will be reduced due to outdoor temperature decrease.
- * If outdoor temperature becomes very low, please operate with other heating equipments.

Defrosting:

- * When outdoor temperature is low but high humidity, after a long while running, frost will form on outdoor unit, that will effect the heating effect, at this time, the auto defrosting function will act, the heat running will stop for 8-10mins.
- * During the auto defrosting, the fan motors of indoor unit and outdoor unit will stop.
- * During the defrosting, the indoor indicator flashes, the outdoor unit may emit vapor. This is due to the defrosting, it isn't malfunction.
- * After defrosting finished, the heating will recover automatically.

Anti-cool wind function:

In Heat mode, the following three kinds of status, if indoor heat exchanger hasn't achieve certain temperature that indoor fan motor will not start, in this way to prevent blowing cool wind (within 3mins):

1. Heat operation just started up.
2. After Auto defrosting operation is finished.
3. Heating under low temperature.

The climate type of this unit is according to the nameplate.

◆ Names and functions of each part

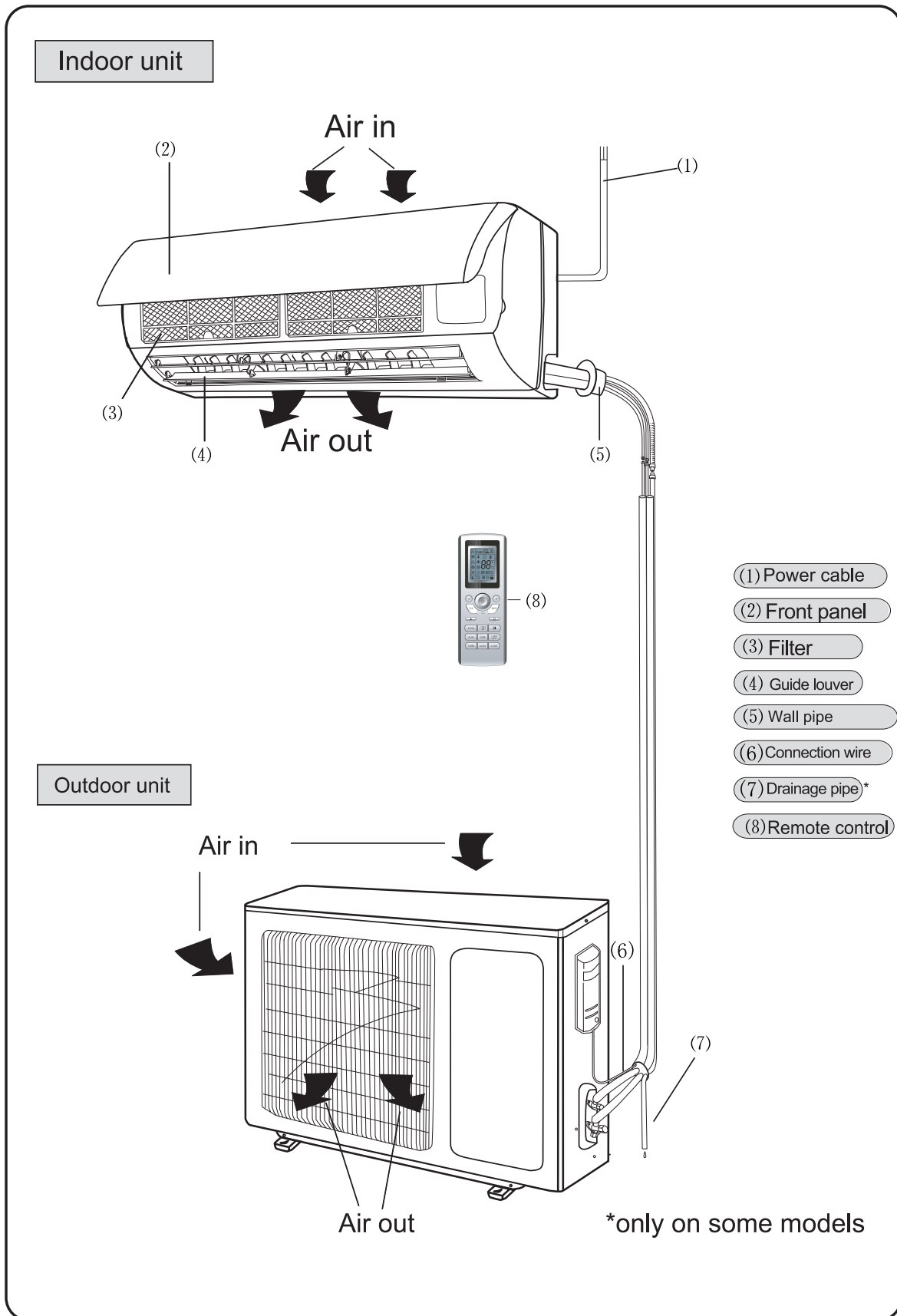

◆ Operation of wireless remote control

Name and function of wireless remote control

Note: Be sure that there are no obstructions between receiver and remote controller; Don't drop or throw the remote control; don't let any liquid in the remote control and put the remote control directly under the sunlight or any place where is very hot.

Signal transmitter



Remote control

SLEEP

SLEEP button

- Press this button, Sleep On and Sleep Off can be selected. After powered on, Sleep Off is defaulted. After the unit is turned off, the Sleep function is canceled. After Sleep function set up, the signal of Sleep will display. In this mode, the time of timer can be adjusted. Under Fan and Auto modes, this function is not available.

FAN

FAN button

- Press this button, Auto, Low, Middle, High speed can be circularly selected. After powered on, Auto fan speed is default. Under Dehumidify mode, Low fan speed only can be set up.

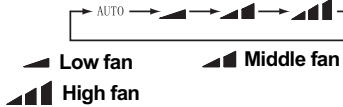

CLOCK

CLOCK button

- Press this button, the clock can be set up, signal ⊕ blink and display. Within 5 seconds, the value can be adjusted by pressing + or - button, if continuously press this button for 2 seconds above, in every 0.5 seconds, the value on ten place of Minute will be increased 1. During blinking, repress the Clock button, signal ⊕ will be constantly displayed and it denotes the setting succeeded. After powered on, 12:00 is defaulted to display and signal ⊕ will be displayed. If there is signal ⊕ be displayed that denotes the current time value is Clock value, otherwise is Timer value.

TEMP

TEMP button

- Press this button, can set up temperature: presetting temperature (to display room), indoor ambient temperature (to display indoor temperature), outdoor ambient temperature (to display outdoor temperature), and that will go around. It is defaulted that there is no signal displaying. Remark: when operating this button, the wireless remote control displays the presetting temperature all along.

ON/OFF button

- Press this button, the unit will be turned on, press it once more, the unit will be turned off. When turning on or turning off the unit, the Timer, Sleep function will be canceled, but the presetting time is still remained.

MODE

MODE button

- Press this button, Auto, Cool, Dry, Fan, Heat mode can be selected circularly. Auto mode is default while power on. Under Auto mode, the temperature will not be displayed; Under Heat mode, the initial value is 28°C (82°F); Under other modes, the initial value is 25°C (77°F).

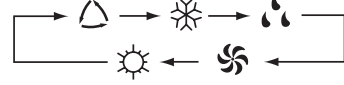

- AUTO**
- COOL**
- DRY**
- FAN**
- HEAT**
(Only for cooling and heating unit.)

◆ Operation of wireless remote control

Names and functions of wireless remote control

Notice: This is a general use remote controller, it could be used for the air conditioners with multifunction; For some function, which the model doesn't have, if press the corresponding button on the remote controller that the unit will keep the original running status.



Remote control

BLOW

BLOW button

- Press this button, can turn on or turn off the drying. In Cool and Dehumidifying mode, press this button and will display "BLOW", at this time the Blow is turned on. If repress this button, "BLOW" will be concealed, at this time the Blow function is turned off. After powered on, Blow OFF is defaulted. When operating the ON/OFF button, or switching mode to Cool or Dehumidifying mode, the Blow function will keep the original status. If unit is turned off, Blow OFF only can be set up and send the signal. In Auto, Fan as well as Heat mode, Blow function can not be set up and there is no "BLOW" displaying.

TURBO

TURBO button *

- In Cool or Heat mode, press this button can turn on or turn off the Turbo function. After turned on the Turbo function, its signal will be displayed. When switching the mode or changing fan speed, this function will be canceled automatically. function will be canceled automatically. (This function may be not available for some units).

+

+ button

- For presetting temperature increasing. Press this button, can set up the temperature, when unit is on. Continuously press and hold this button for more than 2 seconds, the corresponding contents will be changed rapidly, until unpress the button then send the information, °F displaying all along. In Auto mode, the temperature can not be set up, but operate this button can send the signal. Centigrade setting range :16-30; Fahrenheit scale setting range 61-86.

-

- button

- Presetting temperature can be decreased. Press this button, the temperature can be set up, continuously press this button and hold for two seconds, the relative contents can quickly change, until unhold this button and send the order that the °F signal will be displayed all the time. The temperature adjustment is unavailable under the Auto mode, but the order can be sent by if pressing this button.

LIGHT

LIGHT button

- Press this button at unit On or Off status, Light On and Light Off can be set up. After powered on, Light On is defaulted.

*only on some models

◆ Operation of wireless remote control

Name and function of wireless remote control

Notice: This is a general use remote controller, it could be used for the air conditioners with multifunction; For some function, which the model doesn't have, if press the corresponding button on the remote controller that the unit will keep the original running status.



Remote control



SWING UP and DOWN BUTTON

- Press this button, to set up swing angle, which circularly changes as below:



This is an universal use remote controller. If remote controller sends the following three kinds of status that the swing status of main unit will be:



When the guide louver start to swing up and down, if turn off the Swing, the air guide louver will stop at current position.

which indicates the guide louver swings up and down between that all five positions.



AIR BUTTON

- Press this button, Air On or Air Off can be selected.

TIMER ON

TIMER ON BUTTON

- Timer On setting: Signal "ON" will blink and display, signal will conceal, the numerical section will become the timer on setting status. During 5 seconds blink, by pressing + or - button to adjust the time value of numerical section, every press of that button, the value will be increased or decreased 1 minute. Hold pressing + or - button, 2 seconds later, it quickly change, the way of change is: During the initial 2.5 seconds, ten numbers change in the one place of minute, then the one place is constant, ten numbers change in the tens place of minute at 2.5 seconds speed and carry. During 5s blink, press the Timer On button, the timer setting succeeds. The Timer On has been set up, repress the timer On button, the Timer On will be canceled. Before setting the Timer, please adjust the Clock to the current actual time.

TIMER OFF

TIMER OFF BUTTON

- Once press this key to enter into TIMER OFF setup, in which case the TIMER OFF icon will blink. The method of setting is the same as for TIMER ON.



HEALTH BUTTON

- Press this button, can set up Health function on or off. After unit is turned on, Health function ON is defaulted.

I FEEL

I FEEL BUTTON

- Press this button, to turn on the I FEEL function. When operating other function and after signal was sent out, every 200ms later, the I FEEL information will be sent out. After I FEEL function turned on, in every 10mins, the remote controller will send the temperature information to main controller. If repress this button, the I FEEL function will be turned off.

◆ Operation of wireless remote control

Guide for operation- general operation

1. After powered on, press ON/OFF button, the unit will start to run. (Note: When it is powered off, the guide louver of main unit will close automatically.)
2. Press MODE button, select desired running mode, or press COOL or HEAT mode to enter into the corresponding operation directly.
3. Pressing + or - button, to set the desired temperature (It is unnecessary to set the temp. at AUTO mode.)
4. Pressing FAN button, set fan speed, can select AUTO FAN, LOW, MID and HIGH.
5. Pressing  button, to select the swing.

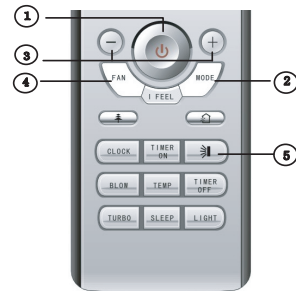

Guide for operation- Optional operation

1. Press SLEEP button, to set sleep.
2. Press TIMER ON and TIMER OFF button, can set the scheduled timer on or timer off.
3. Press LIGHT button, to control the on and off of the displaying part of the unit (This function may be not available for some units).
4. Press TURBO button, can realize the ON and OFF of TURBO function.

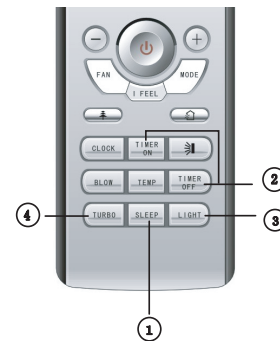

Introduction for special function

★ About blow function

This function indicates that moisture on evaporator of indoor unit will be blown after the unit is stopped to avoid mould.

1. Having set blow function on: After turning off the unit by pressing ON/OFF button indoor fan will continue running for about 10 min. at low speed. In this period, press blow button to stop indoor fan directly.
2. Having set blow function off: After turning off the unit by pressing ON/OFF button, the complete unit will be off directly.

★ About AUTO RUN

When AUTO RUN mode is selected, the setting temperature will not be displayed on the LCD, the unit will be in accordance with the room temp. automatically to select the suitable running method and to make ambient comfortable.

★ About turbo function (This function may be not available for some units).



If start this function, the unit will run at super-high fan speed to cool or heat quickly so that the ambient temp. approaches the preset temp. as soon as possible.

◆ Operation of wireless remote control

★ About lock

Press + and - buttons simultaneously to lock or unlock the keyboard. If the remote controller is locked, the icon  will be displayed on it, in which case, press any button, the mark will flicker for three times. If the keyboard is unlocked, the mark will disappear.

★ About swing up and down

1. Press swing up and down button continuously more than 2s, the main unit will swing back and forth from up to down, and then loosen the button, the unit will stop swinging and present position of guide louver will be kept immediately.
2. Under swing up and down mode, when the status is switched from off to , if press this button again 2s later,  status will switch to off status directly; if press this button again within 2s, the change of swing status will also depend on the circulation sequence stated above.

★ About switch between Fahrenheit and Centigrade

Under status of unit off, press MODE and - buttons simultaneously to switch °C and °F.

★ About new function of defrosting

It indicates: after starting this function by remote controller and the unit has been under defrost status, if turn off the unit by remote controller, the unit will not stop defrosting until it is finished; if change setting mode by remote controller, the function, which is set last time, won't be carried out until defrosting finished.

Operation of this function on or off: If remote controller is under off status, press mode button and blow button simultaneously in order to enter or cancel this new function. If the unit is under defrost mode, dual eight position on remote controller will display H1. If switch to heat mode, the position will display H1, which flickers for 5s, in which case, press +/- button, H1 will disappear and setting temp. be displayed.

After remote controller is powered on, the new defrost function will be defaulted to be closed.

Changing batteries and notices

1. Slightly to press the place with , along the arrowhead direction to push the back cover of wireless remote control. (As show in figure)
2. Take out the old batteries. (As show in figure)
3. Insert two new AAA1.5V dry batteries, and pay attention to the polarity. (As show in figure)
4. Attach the back cover of wireless remote control. (As show in figure)

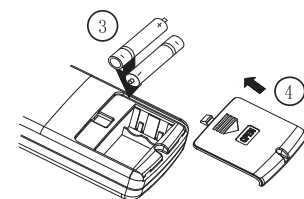
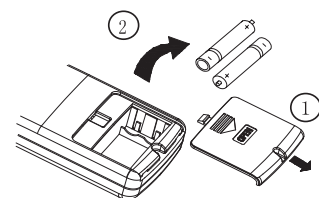

Sketch map for changing batteries

★ NOTE:

- When changing the batteries, do not use the old or different batteries, otherwise, it can cause the malfunction of the wireless remote control.
- If the wireless remote control will not be used for a long time, please take them out, and don't let the leakage liquid damage the wireless remote control.
- The operation should be in its receiving range.
- It should be placed at where is 1m away from the TV set or stereo sound sets.
- If the wireless remote control can not operate normally, please take them out, after 30s later and reinsert, if they cannot normally run, please change them.

◆ Emergency Operation

Emergency Operation

When the wireless remote control is lost or damaged, please use the manual switch, at this time, it is running in Auto Run mode that will not change the temperature setting value and fan speed.

The manual switch can be operated as follow:

- At operation: When the unit stopped running, press ON/OFF button, unit will enter into AUTO RUN mode. The microcomputer will accord to the room temperature to select the (COOL, HEAT, FAN) mode automatically, to obtain the comfortable effect.
- At stopping: When the unit is running, press the ON/OFF button of the manual switch, the unit will stop work.

The code switch can be operated as follow:

- At operation: When the unit is stopped running, adjust the code switch to AUTO, the unit will enter into AUTO RUN mode. The microcomputer will accord to the room temperature to select the (COOL, HEAT, FAN) mode automatically, to obtain the comfortable effect.
- At stopping: When the unit is running, adjusts the code switch to STOP position, the unit will stop work.

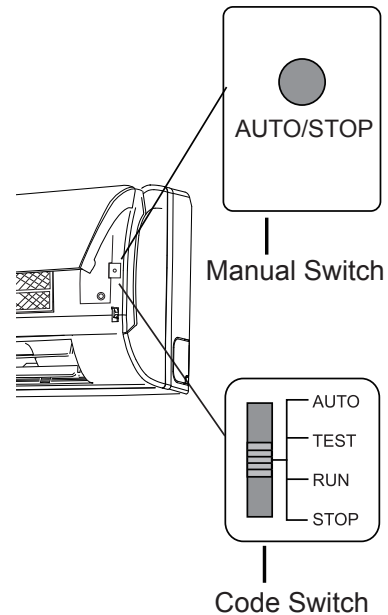

◆ Clean and care



CAUTION

- Turn power off and pull out the power plug before cleaning air conditioner. Or it may cause electric shock.
- Never sprinkle water on the indoor unit and the outdoor unit for cleaning because it can cause an electric shock.
- Volatile liquid (e.g. thinner or gasoline) will damage the air conditioner. (So wipe the units with a dry soft cloth, or a cloth slightly moistened with water or cleanser.)

Clean the front panel(make sure to take it off before cleaning)

① Take off the front panel

Along the direction of arrows to lift the front panel up, meanwhile to hold both slots of the front panel and take it out forcibly and then can take it off.

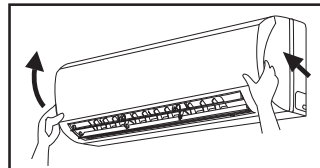

② Washing

Clean with a soft brush, water and neutral detergent and then dry it.(Note: Before cleaning the unit, please take down the displayer box firstly, then to wash the panel, if the unit has displayer on the front panel. Never use the water above 45°C to wash the panel, or it could cause deformation or discoloration.)

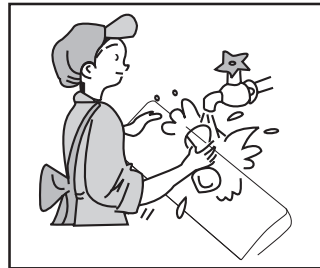

③ Install front panel

Place two supporters of the front panel into the slots, along the direction of arrows to cover and clasp the front panel. As show in right figure.

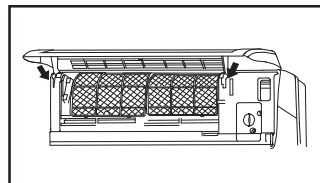

Cleaning the air filters (Recommended once every three months)

Note: If dust is much more around the air conditioner, the air filters should be cleaned many times. After taking off the filter, don't touch the fin of indoor unit, in order to avoid hurt your fingers.

◆ Clean and care

① Take down the air filter

At the slot of surface panel to open an angle, pull the air filter downward and take it out.

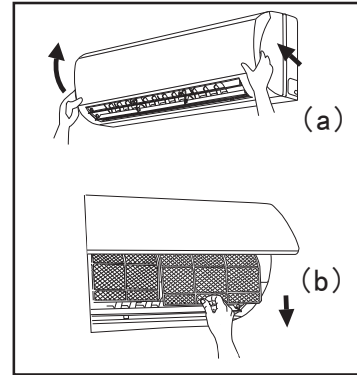

② Cleaning

To clean the dust adhering to the filters, you can either use a vacuum cleaner, or wash them with warm water (the water with the neutral detergent should be below 45 °C). When the filters are very dirty (such as oil stain), and dry it in the shade.

NOTE: Never use water above 45 °C to wash, or it can cause deformation or discoloration. Never parch it by fire, or can cause a fire or deformation.

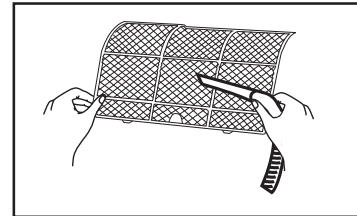

③ Reinsert the filters

Reinsert the filters along with the arrow head, then cover the surface panel and clasp it.

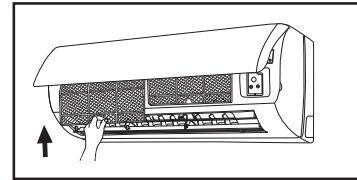

Check before use

- ① Be sure that nothing obstructs the air outlet and intake vents.
- ② Check that whether ground wire is properly connected or not.
- ③ Check that whether the batteries of air conditioner are changed or not.
- ④ Check that whether the installation stand of the outdoor unit is damaged or not. If damaged, please contact the dealer.

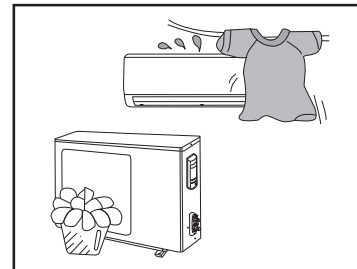

Maintain after use



- ① Turn main power off.
- ② Clean the filter and indoor and outdoor units' bodies.
- ③ Repaint the rubiginous place on the outdoor unit to prevent it from spreading.

◆ Troubleshooting

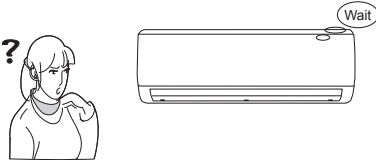
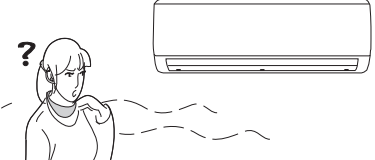
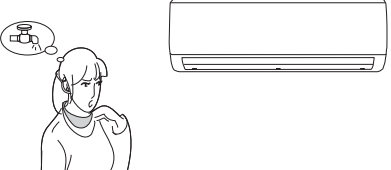

Warning

Do not repair the air conditioner at your discretion. Incorrect repair may cause electric shock or fire, so please contact Authorized Service Center for professional repair. Following checks prior to contact may save your time and costs.

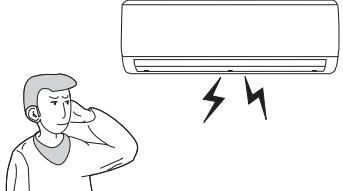
Phenomenon	Troubleshooting
<p>Air conditioner does not run upon immediately restart after a stop.</p> 	<ul style="list-style-type: none"> ● To protect the air conditioner upon immediate restart after a stop, the microcomputer controller will delay the unit for 3 minutes before the air conditioner will run.
<p>Air conditioner blows out bad smell when it is initially started.</p> 	<ul style="list-style-type: none"> ● The air conditioner itself has no bad smell. If any. It is the bad smell accumulated from environment. Solution: Clean the air filter. ● If still any problem, the air conditioner shall be cleaned (Please contact Authorized Service Center).
<p>You may hear "Water Flowing" noise when the air conditioner is running.</p> 	<ul style="list-style-type: none"> ● When the air conditioner is started, or the compressor is started or stopped during running or the air conditioner is stopped, sometimes you may hear "hua-hua" or "di-di" noise. This is the flowing sound of refrigerant other than fault.
<p>Sometimes a thin fog will flow out of the outlet when air conditioner is running under cooling mode.</p> 	<ul style="list-style-type: none"> ● This might occur when indoor temperature and humidity are high. This is because the indoor air is quickly cooled down. After a period of time, the fog will disappear with the decrease of indoor temperature and humidity.
<p>You may hear a slight crack when the air conditioner is started or stopped.</p> 	<ul style="list-style-type: none"> ● This is the sound of friction caused by expansion of panel or other parts due to the change of temperature.

◆ Troubleshooting

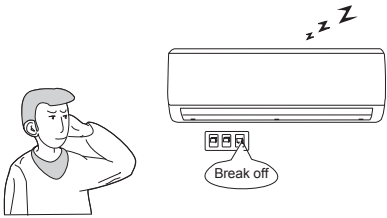
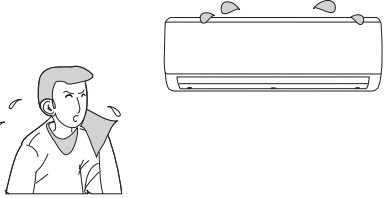
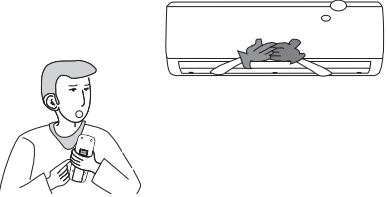
Phenomenon	Troubleshooting
<p>The unit can not run.</p> 	<ul style="list-style-type: none"> ● Has the power been shut down? ● Does power plug come loose from the socket? ● Is the circuit protection device tripped off or not? ● Is voltage higher or lower? (Tested by professionals) ● Is the Timer correctly used?
<p>Cooling(Heating) efficiency is not good.</p> 	<ul style="list-style-type: none"> ● Is Temp. setting suitable? ● Were inlet and outlet vents obstructed? ● Is there too much dusts accumulated and obstructed the filter? ● Are the windows and doors closed? ● Did Fan speed set at low speed? ● Is there any heat sources in the room?
<p>Wireless remote control is not available.</p> 	<ul style="list-style-type: none"> ● The unit is interfered by abnormal or frequent functions switchover occasionally the controller cannot operate. At this time, you need to pull out of the plug, and reinsert it. ● Is it in its receiving range? Or obstructed? To check the voltage in wireless remote control inside is charged, otherwise to replace the batteries. ● Whether the wireless remote control is damaged.
<p>If water leakage in the room.</p>	<ul style="list-style-type: none"> ● The air humidity is on the high side. ● Condensing water over flowed. ● The connection position of indoor unit drainage pipe is loosed.
<p>If water leakage in outdoor unit.</p>	<ul style="list-style-type: none"> ● When the unit is running in COOL mode, the pipe and connection of pipe would be condensed due to the water cooled down. ● When the unit is running in Auto Defrosting mode, the ice thawed and flowed out. ● When the unit is running in HEAT mode, the water adhered on heat exchanger dripped off.
<p>Noise from indoor unit emitted.</p>	<ul style="list-style-type: none"> ● The sound of fan or compressor relay is switching on or off. ● When the defrosting is started or stop running, it will sound. That is due to the refrigerant flowed to the reverse direction.

◆ Troubleshooting

Phenomenon	Troubleshooting
Indoor unit cannot deliver air.	<ul style="list-style-type: none"> ● In HEAT mode, when the temperature of indoor heat exchanger is very low, that will stop deliver air in order to prevent cool air. (Within 3min) ● In HEAT mode, when the outdoor temperature is low or high humidity, there are much frost be formed on the outdoor heat exchanger, that the unit will automatically defrost, indoor unit stop blowing air for 3-12mins. During the defrosting, there is water flowing out or vapor be produced. ● In dehumidifying mode, sometimes indoor fan will stop, in order to avoid condensing water be vaporized again, restrain temperature rising.
Moisture on air outlet vent.	<ul style="list-style-type: none"> ● If unit is running under the high humidity for a long time, the moisture will be condensed on the air outlet grill and drip off.



Immediately stop all operations and plug out, contact the dealer in following situations.

- There is harsh sound during operation.
- The terrible odors emitted during operation.
- Water is leaking in the room.
- Air switch or protection switch often breaks.
- Careless splash water or something into unit.
- There is an abnormal heat in power supply cord and power plug.



Stop running and pull out of the plug.

◆ Installation service- Notices for installation



Important Notices

1. The unit installation work must be done by qualified personnel according to the local rules and this manual.
2. If the air conditioner has not plug, directly connect it into the fixed circuit, a breaker should be installed in the fixed circuit. all pole of this breaker should be switching off and the distance of the contact should be at least 3mm.

Basic Requirements For Installation Position

Install in the following place may cause malfunction. If it is unavoidable contact with service center please:

- Place where strong heat sources, vapors, flammable gas or volatile object are emitted.
- Place where high-frequency waves are generated by radio equipment, welders and medical equipment.
- Place where a lot of salinities such as coast exists.
- Place where the oil (machine oil) is contained in the air.
- Place where a sulfured gas such as the hot spring zones is generated.
- Other place with special circumstance.

Indoor Unit Installation Position Selection

1. The air inlet and outlet vent should be far from the obstruction, make sure that the air can be blown through the whole room.
2. Select a position where the condensing water can be easily drained out, and the place is easily connected for outdoor unit.
3. Select a location where the children can not reach.
4. Can select the place where is strong enough to withstand the full weight and vibration of the unit. And will not increase the noise.
5. Be sure to leave enough space to allow access for routine maintenance. The height of the installed location should be 230 cm or more from the floor.
6. Select a place about 1m or more away from TVset or any other electric appliances.
7. Select a place where the filter can be easily taken out.
8. Make sure that the indoor unit installation should accord with installation dimension diagram requirements.

Outdoor Unit Installation Position Selection

1. Select a location from which noise and outflow air emitted by unit will not inconvenience neighbors, animals, plants.
2. Select a location where there should be sufficient ventilation.
3. Select a location where there should be no obstructions cover the inlet and outlet vent.
4. The location should be able to withstand the full weight and vibration of the outdoor unit and permit safe installation.
5. Select a dry place, but do not expose under the direct sunlight or strong wind.
6. Make sure that the outdoor unit installation dimension should accord with installation dimension diagram, convenient for maintenance, repair.
7. The height difference of connecting the tubing within 5m, the length of connecting the tubing within 10m.
8. Select a place where it is out of reach for the children.
9. Select a place where will not block the passage and do not influence the city appearance.

◆ Notices for installation

Safety Requirements For Electric Appliances

1. The power supply should be used the rated voltage and AC exclusive circuit, the power cable diameter should be satisfied.
- 2 Don't drag the power cable emphatically.
- 3 It should be reliably earthed, and it should be connected to the special earth device, the installation work should be operated by the professional.
The air switch must have the functions of magnetic tripping and heat tripping, in order to protect the short circuit and overloading.
4. The min. distance from the unit and combustive surface is 1.5m.

Note:

- Make sure that the Live wire or Zero line as well as the earth wire in the family power socket can not be wrong connected, there should be reliable and no short circuit in the diagram.
- wrong connection may cause fire.

Earthing requirements

1. Air conditioner is type I electric appliance, thus please do conduct reliable earthing measure.
2. The yellow-green two-color wire in air conditioner is earthing wire and cannot be used for other propose. It cannot be cut off and be fix it by screw, otherwise it would cause electric shock.
3. The earth resistance should accord to the National Criterion.
4. The user power must offer the reliable earthing terminal. Please don't connect the earthing wire with the following place:
 - ① Tap water pipe.
 - ② Gas pipe.
 - ③ Contamination pipe.
 - ④ Other places that professional personnel consider them unreliable.

Others

1. The connection method of unit and power cable as well as the interconnect method of each isolated component should refer to the circuit diagram stick on the unit.
2. The model of the blown fuse and rated value should refer to the silk-screen on the controller or fuse sleeve.
3. The appliance shall be installed in accordance with national wiring regulations.
4. This appliance is not intended for use by persons (including children) with reduced physical, sensory or mental capabilities, or lack of experience and knowledge, unless they have been given supervision or instruction concerning use of the appliance by a person responsible for their safety.
5. Children should be supervised to ensure that they do not play with the appliance.

◆ Installation dimension diagram

Installation dimension diagram

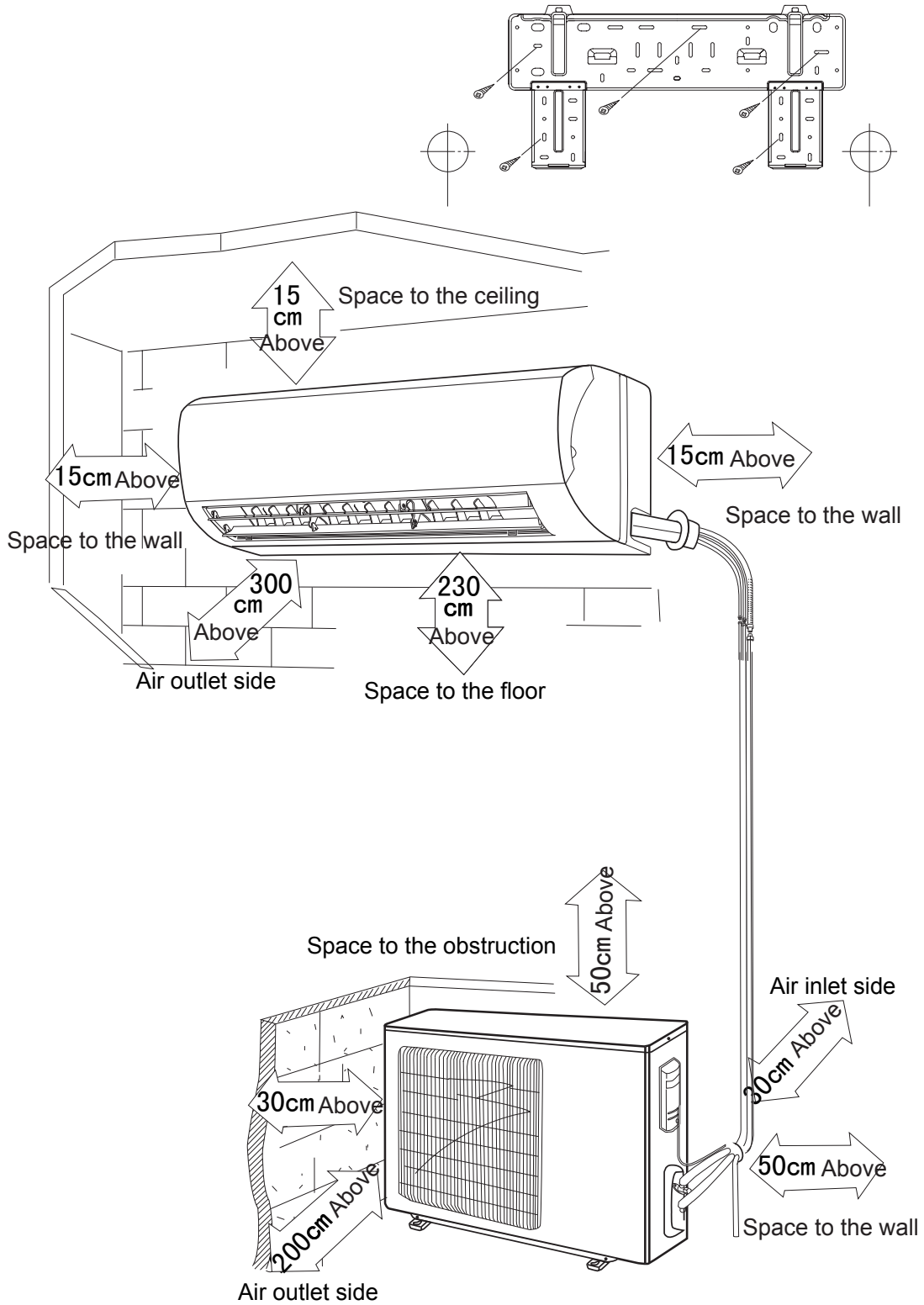

◆ Install indoor unit

Install the rear panel

1. Always mount the rear panel horizontally. As the water drainage pipe at the left, when adjusting the rear panel, this side should not be too high; the right side should be slightly high.
2. Fix the rear panel on the selected location
3. Be sure that the rear panel has been fixed firmly enough to withstand the weight of an adult of 60kg, furthermore, the weight should be evenly shared by each screw.

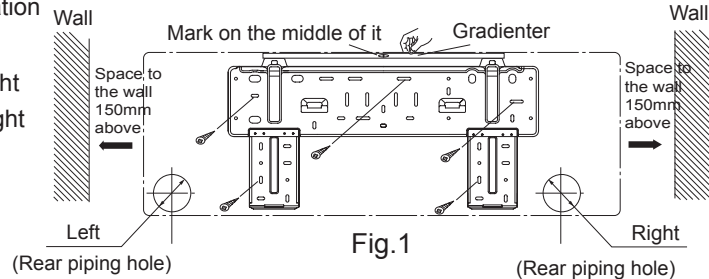

Install the piping hole

1. Make the piping hole in the wall at a slight downward slant to the outdoor side.
2. Insert the piping-hole sleeve into the hole to prevent the connection piping and wiring from being damaged when passing through the hole.

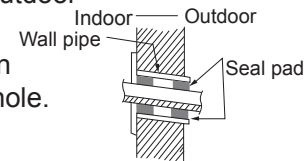

Install the water drainage pipe

1. For well draining, the drain hose should be placed at a downward slant.
2. Do not wrench or bend the drain hose or flood its end by water.
3. When the long drainage hose passing through indoor, should wrap the insulation materials.

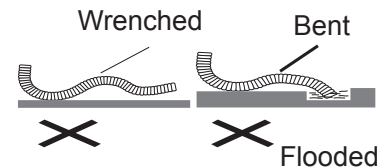

Connect indoor and outdoor electric wires

1. Open the front panel upwardly.
2. Screw off the fixing screw of cover plate and screw off cover plate.
3. Put the power connection cable through the back of indoor unit wire hole and take it out.
4. All the wiring should be connected according to the circuit diagram on the unit.
5. Put the power connection cable the section, which with sheath into wire groove, and cover the cover plate, screw on the fixing screw, tighten the connection wire.
6. Cover the front panel cover.
7. For the cooling and heating unit, signal control wire can be passed through the connection of connector and indoor unit, and use the wire clip that is under the body case, tighten the signal control wire.

◆ Install indoor unit

NOTE:

When connecting the electric wire if the wire length is not enough, please contact with the authorized service shop to buy a exclusive electric wire that is long enough and the joint on the wire are not allowed.

- The electric wiring must be correctly connected, wrong connection may cause spare parts malfunction.
- Tighten the terminal screw in order to prevent loose.
- After tighten the screw, slightly pull the wire and confirm whether is it firm or not.
- If the earth wire is wrong connection, that may cause electric shock.
- The cover plate must be fixed, and tighten the connection wire, if it is poor installed, that the dust, moisture may enter in or the connection terminal will be affected by outside force, and will cause fire or electric shock.
- Leakage circuit-breaker and air switch of correct capacity must be installed.

Install the indoor unit

- The piping can be lead out from right, right rear, left, left rear.
1. When routing the piping and wiring from the left or right side of indoor unit, cut off the tailings from the chassis in necessary. (show in Fig.2)
 - (1)Cut off the tailings 1 when routing the wiring only.
 - (2)Cut off the tailings 1 and tailings 2 when routing both the wiring and piping.(or 1,2,3)
 2. Take out the piping from body case, wrap the piping electric wire, water pipe with tape and put them through the piping hole.(As show in Fig. 3)
 3. Hang the mounting slots of the indoor unit on the upper tabs of the rear panel and check if it is firm enough. (As show in Fig.4)

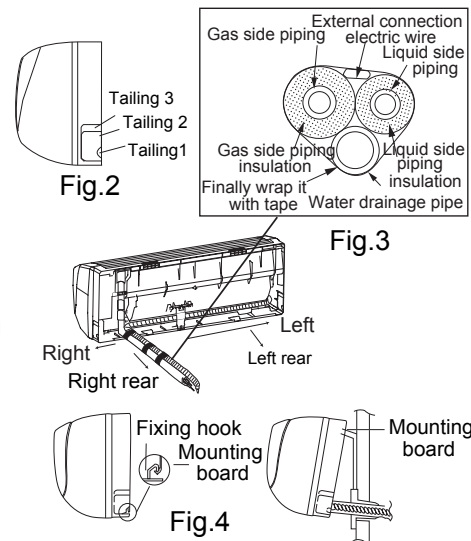

Install the connection pipe

1. Align the center of the piping flare with the relevant valve.
 2. Screw in the flare nut by hand and then tighten the nut with spanner and torque wrench refer to the following.
- Tightening torque table:

Hex nut diameter	Tightening torque (N · m)
Φ6	15~20
Φ 9. 52	31~35
Φ 12	50~55
Φ 16	60~65
Φ 19	70~75

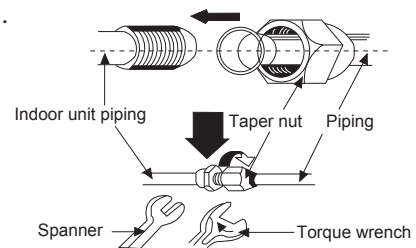

NOTE: Firstly connect the connection pipe to indoor unit, then to outdoor unit; pay attention to the piping bending, do not damage the connection pipe; the joint nut couldn't tighten too much, otherwise it may cause leakage.

◆ Install outdoor unit

Electric Wiring

1. Disassemble handle of right side plate or front side plate of outdoor unit.
2. Take off wire clamp, connect and fix power connect cord to terminal of line bank.
Wiring should fit that of indoor unit.
3. Fix the power connection cable with wire clamp, for cooling and heating unit, then use the wire clamp to fix the signal control wire, then connect the corresponding connector.
4. Ensure if wire has been fixed well.
5. Install handle or front side plate.

NOTE:

- Wrong wiring may cause spare parts malfunction.
- After the cable fixed, make sure there should be a free space between the connection and fixing place on the lead wire.

Air purging and leakage test

● Air purging and leakage test

1. Connect charging hose of manifold valve to charge end of low pressure valve (both high/low pressure valves must be tightly shut).
2. Connect joint of charging hose to vacuum pump.
3. Fully open handle of Lo manifold valve.
4. Open the vacuum pump to evacuate. At the beginning, slightly loosen joint nut of low pressure valve to check if there is air coming inside. (If noise of vacuum pump has been changed, the reading of multimeter is 0) Then tighten the nut.
5. Keep evacuating for more than 15mins and make sure the reading of multi-meter is $-1.0 \times 10^5 \text{pa}$ (-76cmHg).
6. Fully open high/low pressure valves.
7. Remove charging hose from charging end of low pressure valve.
8. Tighten bonnet of low-pressure valve. (As shown in Fig.5)

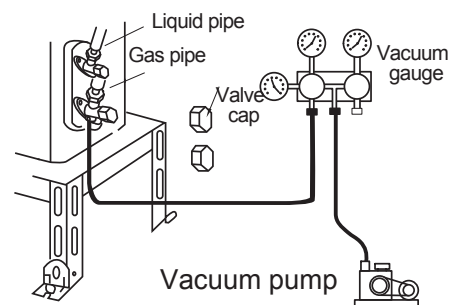

Fig. 5

◆ Install outdoor unit

● Leak hunting

Use soap water or leak hunting meter to check whether the joints is leak.

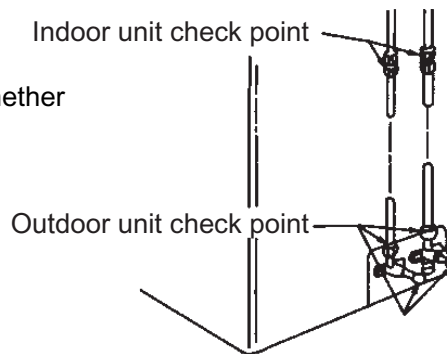
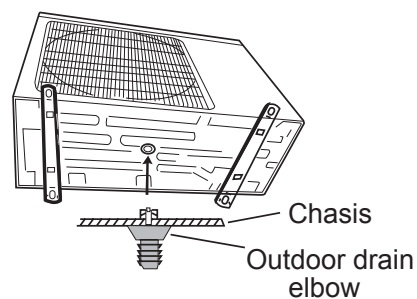

Fig.6

Outdoor condensation drainage (Heat pump type only)

When the unit is heating, the condensing water and defrosting water can be drained out reliably through the drain hose.

Installation: Install the outdoor drain elbow in $\varnothing 25$ hole on the base plate, and joint the drain hose to the elbow, so that the wastewater formed in the outdoor unit can be drained out to a proper place.



◆ Check after installation and test operation

Check after installation

Items to be checked	Possible malfunction
Has it been fixed firmly?	The unit may drop, shake or emit noise.
Have you done the refrigerant leakage test?	It may cause insufficient cooling(heating) capacity.
Is heat insulation sufficient?	It may cause condensation and dripping.
Is water drainage well?	It may cause condensation and dripping.
Is the voltage in accordance with the rated voltage marked on the nameplate?	It may cause electric malfunction or damage the part.
Is the electric wiring and piping connection installed correctly and securely?	It may cause electric malfunction or damage the part.
Has the unit been connected to a secure earth connection?	It may cause electrical leakage.
Is the power cord specified?	It may cause electric malfunction or damage the part
Is the inlet and outlet been covered?	It may cause insufficient cooling(heating) capacity.
Has the length of connection pipes and refrigerant capacity been recorded?	The refrigerant capacity is not accurate.

Test Operation

1. Before test operation

- (1) Do not switch on power before installation is finished completely.
- (2) Electric wiring must be connected correctly and securely.
- (3) Cut-off valves of the connection pipes should be opened.
- (4) All the impurities such as scraps and thrams must be cleared from the unit.

2. Test operation method

- (1) Switch on power, press "ON/OFF" button on the wireless remote control to start the operation.
- (2) Press MODE button, to select the COOL, HEAT, FAN to check whether the operation is normal or not.

◆ Installation and Maintenance of Healthy Filter

Installation Instructions

1. Forcibly pull the panel for a specific angle from the two ends of the front panel according to the arrow direction. Then pull the air filter downwards to remove it. (See Fig.a)

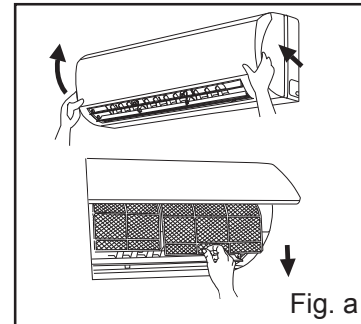

2. Mount the healthy filter onto the air filter, (as shown in Fig.b). If the air filter cannot be installed, please mount the healthy filter on the front case. (as shown in Fig.c).

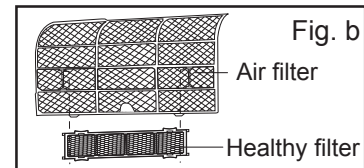

3. Mount the air filter properly along the arrow direction in Fig.d, and then close the panel cover.

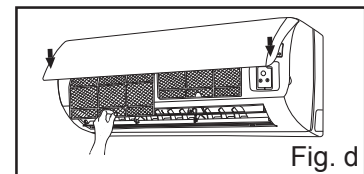
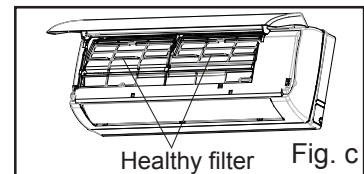

Cleaning and Maintenance

Take out the healthy filter before cleaning and reinstall it after cleaning according to the installation instruction. Pay special attention to that silver ion filter can't be cleaned with water, while active carbon, photocatalyst, low temperature conversion (LTC) catalyst, formaldehyde eliminator, catechin or mite killing filter can, but can't with brush or hard things. Dry it in the shade or sun after cleaning, but not by wiping.

Service Life

The healthy filter commonly has its usage lifetime for one year under normal condition. As for silver ion filter, it is invalid when its surface becomes black (green).

- This supplementary instruction is provided for reference to the unit with healthy filter. If the graphics provided herein is different from the physical goods, the latter one shall prevail. The quantity of healthy filters shall be based on the actual delivery.

TECHNICAL DATA

GENERAL INFORMATION

MODELS	9K	12K	18K	24K	28K		
General data							
Electricity supply	230~50 (*)				230~50	V~Hz	
Refrigerant gas	R410 A (**)				R410 A		
Fuse	10	15	15	15	20	A	
Minimum cable section	1,5	2,5	2,5	2,5	2,5	mm ²	
Size and clearance							
	L	770	830	1020	1020	1178	mm
	H	250	285	310	310	326	mm
	P	205	215	250	250	253	mm
	A	150				150	mm
	B	150				150	mm
	C	2500				2500	mm
	D	150				150	mm
	L	763	763	848	848	920	mm
	P	258	258	378	378	440	mm
	H	515	515	620	620	790	mm
	C	300				300	mm
	D	500				500	mm
	F	300				300	mm
	E	2000				2000	mm
Indoor unit net weight	8	11	14	14	17,5	kg	
Outdoor unit net weight	40	40	52	52	68	kg	
Connecting pipes							
Refrigerant pipe size	Liquid	6,0 - 1/4"	6,0 - 1/4"	6,0 - 1/4"	10-3/8"	6,0 - 1/4"	Ø-inch
	Gas	12 - 3/8"	12 - 1/2"	12 - 1/2"	16-5/8"	16-5/8"	Ø-inch
Pipe tightening torque	Liquid	20	20	20	40	20	Nm
	Gas	60	60	60	80	80	Nm
Quantity of refrigerant per metre of pipe (over 5 m)	15	15	22	22	30	g/m	
	A (max)	6	6	8	8	15	m
	B (max)	10	10	30	30	30	m
	C (max)	5	5	8	8	15	m
Refrigerant charge	(***)						g.
Operating limits							
	Internal part bulb			External part bulb			
Cooling (Max ; Min)	36 ; 16			45 ; -10		°C	
Heating (Max ; Min)	30 ; 16			27 ; -15		°C	

(*) See the rating plate for the electricity supply.

(**) The appliance may be supplied with refrigerant gas R22 in countries where the use of refrigerant gas R410a is not compulsory.

(***) See the rating plate for the refrigerant charge.

DE'LONGHI Appliances - Via Seitz, 47 - 31100 Treviso - Italia

5717310121/09.09